

# TPS61299 95nA Quiescent Current, 5.5V Boost Converter with Input Current Limit and Fast Transient Performance

## 1 Features

- Input voltage range: 0.5V to 5.5V
- 0.7V minimum input voltage for start-up
- Input operating voltage down to 150mV with signal  $V_{IN} > 0.7V$
- Output voltage range: 1.8V to 5.5V VSEL pin select output voltage
- Average input current limit: 5mA; 25mA; 50mA; 100mA; 250mA, 500mA, 1.2A, 1.9A (different versions)
- 95nA typical quiescent current from VOUT
- 60nA typical shutdown current from VIN and SW
- Up to 91% efficiency at  $V_{IN} = 3.6V$ ,  $V_{OUT} = 5V$ , and  $I_{OUT} = 10\mu A$
- Up to 94% efficiency at  $V_{IN} = 3.6V$ ,  $V_{OUT} = 5V$ , and  $I_{OUT} = 200mA$
- Fast transient performance: setting time  $\sim 8\mu s$  at  $V_{IN} = 3.6V$ ,  $V_{OUT} = 5V$ ,  $I_{OUT} = 0A \rightarrow 200mA$
- True disconnection or pass through at EN low
- Automatic PFM/PWM mode transition
- Auto pass-through at  $V_{IN} > V_{OUT}$
- Output SCP and thermal shutdown protections
- 6-Pin WCSP (1.2mm x 0.8mm) / SOT563 package (1.6mm x 1.6mm)

## 2 Applications

- [Smart watch, Smart band](#)
- [Portable medical equipment](#)
- [TWS](#)

## 3 Description

The TPS61299x family is a synchronous boost converter with 95nA ultra-low quiescent current and average input current limit. The device provides a power solution for portable equipment with alkaline battery and coin cell battery. This device has high efficiency under light-load condition to achieve long operation time and average input current limit can avoid battery discharging with high current.

The TPS61299x family has wide input voltage range from 0.5V to 5.5V and output voltage range from 1.8V to 5.5V. The device has different versions for average input current limit from 5mA to 1.9A. The TPS61299 with 1.2A current limit can support up to 500mA output current from 3V to 5V conversion and achieve approximately 94% efficiency at 200mA load.

The TPS61299x family has optional fast-load transient performance at output voltage is 4.5V, 5V or 5.5V. In fast-load transient, the typical setting time is 8 $\mu s$  when output current transient from 0A to 200mA.

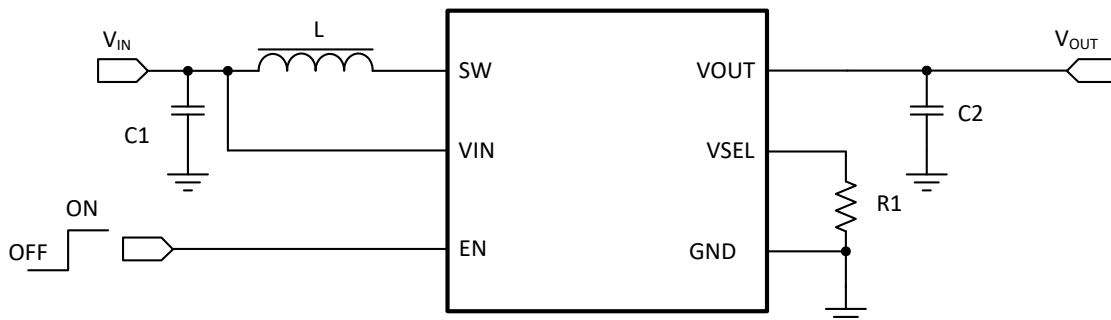
The TPS61299x family supports optional force pass through or true shutdown function when it is disabled, which is flexible for always-on system.

The TPS61299x family offers a very small solution size with 6-ball 1.2mm x 0.8mm WCSP package and 6-pin 1.6mm x 1.6mm SOT563 package.

### Device Information

PART NUMBER	PACKAGE <sup>(1)</sup>	BODY SIZE (NOM)
TPS61299YBHR	WCSP	1.2mm x 0.8mm
TPS61299DRLR	SOT563	1.6mm x 1.6mm

(1) For all available packages, see the orderable addendum at the end of the data sheet.



Typical Application



## Table of Contents

<b>1 Features</b> .....	1	8.2 Typical Application-Li-ion Battery to 5V Boost Converter Under Fast Mode.....	16
<b>2 Applications</b> .....	1	8.3 Typical Application-Li-ion Battery to 5V Boost Converter Under Normal Mode.....	21
<b>3 Description</b> .....	1	8.4 Power Supply Recommendations.....	24
<b>4 Device Comparison Table</b> .....	3	8.5 Layout.....	24
<b>5 Pin Configuration and Functions</b> .....	3	8.6 Thermal Information.....	25
<b>6 Specifications</b> .....	4	<b>9 Device and Documentation Support</b> .....	26
6.1 Absolute Maximum Ratings.....	4	9.1 Device Support.....	26
6.2 ESD Ratings.....	4	9.2 Documentation Support.....	26
6.3 Recommended Operating Conditions.....	4	9.3 Receiving Notification of Documentation Updates....	26
6.4 Thermal Information.....	4	9.4 Support Resources.....	26
6.5 Electrical Characteristics.....	5	9.5 Trademarks.....	26
6.6 Typical Characteristics.....	7	9.6 Electrostatic Discharge Caution.....	26
<b>7 Detailed Description</b> .....	9	9.7 Glossary.....	26
7.1 Overview.....	9	<b>10 Revision History</b> .....	27
7.2 Functional Block Diagram.....	9	<b>11 Mechanical, Packaging, and Orderable Information</b> .....	28
7.3 Feature Description.....	10		
7.4 Device Functional Modes.....	15		
<b>8 Application and Implementation</b> .....	16		
8.1 Application Information.....	16		

## 4 Device Comparison Table

ORDERABLE PART NUMBER	INPUT CURRENT LIMIT	EN_LOW
TPS61299	1.2A	True shutdown
TPS61299-Q1	1.2A	True shutdown

## 5 Pin Configuration and Functions

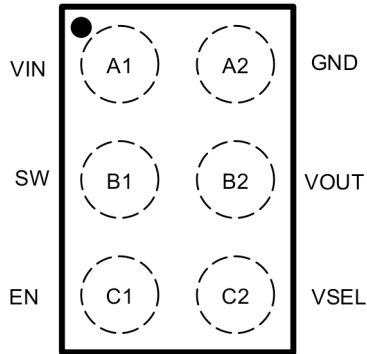


Figure 5-1. YBH Package Top View

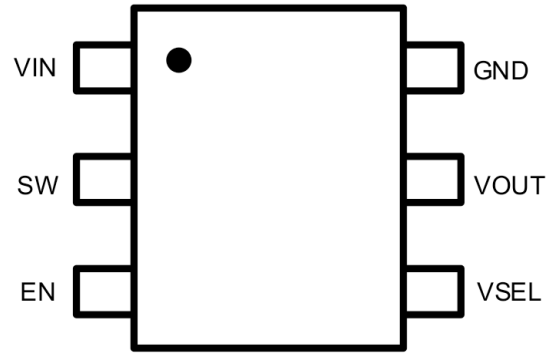


Figure 5-2. DRL Package Top View

Table 5-1. Pin Functions

TERMINAL		DRL	I/O	DESCRIPTION
NAME	YBH			
VIN	A1	1	PWR	IC power supply input
SW	B1	2	I	The switch pin of the converter. It is connected to the drain of the internal low-side power MOSFET and source of the internal high-side power MOSFET.
EN	C1	3	I	Enable logic input. Logic high voltage enables the device. Logic low voltage disables the device.
VSEL	C2	4	I	Boost output voltage selection pin. Connect a resistor between this pin and ground to select one of 21 output voltages.
VOUT	B2	5	PWR	Boost converter output
GND	A2	6	PWR	Ground

## 6 Specifications

### 6.1 Absolute Maximum Ratings

over operating free-air temperature range (unless otherwise noted)<sup>(1)</sup>

		MIN	MAX	UNIT
Voltage	VIN, VOUT, SW, EN, VSEL	-0.3	6.5	V
	SW spike at 10 ns	-0.7	8	V
	SW spike at 1 ns	-0.7	10	V
T <sub>J</sub>	Operating Junction Temperature	-40	125	°C
T <sub>stg</sub>	Storage temperature	-65	150	°C

- (1) Operation outside the Absolute Maximum Ratings may cause permanent device damage. Absolute Maximum Ratings do not imply functional operation of the device at these or any other conditions beyond those listed under Recommended Operating Conditions. If used outside the Recommended Operating Conditions but within the Absolute Maximum Ratings, the device may not be fully functional, and this may affect device reliability, functionality, performance, and shorten the device lifetime.

### 6.2 ESD Ratings

			VALUE	UNIT
V <sub>(ESD)</sub>	Electrostatic discharge	Human body model (HBM), per ANSI/ESDA/ JEDEC JS-001, all pins <sup>(1)</sup>	±2000	V
		Charged device model (CDM), per JEDEC specification JESD22-C101, all pins <sup>(2)</sup>	±500	

- (1) JEDEC document JEP155 states that 500-V HBM allows safe manufacturing with a standard ESD control process. [Following sentence optional; see the wiki.] Manufacturing with less than 500-V HBM is possible with the necessary precautions.
- (2) JEDEC document JEP157 states that 250-V CDM allows safe manufacturing with a standard ESD control process. [Following sentence optional; see the wiki.] Manufacturing with less than 250-V CDM is possible with the necessary precautions.

### 6.3 Recommended Operating Conditions

over operating free-air temperature range (unless otherwise noted)

		MIN	NOM	MAX	UNIT
V <sub>IN</sub>	Input voltage	0.5		5.5	V
V <sub>OUT</sub>	Boost output voltage	1.8		5.5	V
T <sub>J</sub>	Junction temperature	-40		125	°C
L	Effective Inductance	0.47*0.7	1.0	1.0*1.3	μH
C <sub>OUT</sub>	Effective Output Capacitance at the OUT pin, with output current lower than 1A	5*0.8	10		μF
	Effective Output Capacitance at the OUT pin, with output current higher than 1A or TPS612997 is used		20		μF
C <sub>IN</sub>	Effective Input Capacitance at the VIN pin	2.2			μF

### 6.4 Thermal Information

THERMAL METRIC <sup>(1)</sup>		TPS61299	TPS61299	TPS61299	TPS61299	UNIT
		YBH 6-BALLS	YBH 6-BALLS	DRL 6-PINS	DRL 6-PINS	
		Standard	EVM	Standard	EVM	
R <sub>θJA</sub>	Junction-to-ambient thermal resistance	130.0	107.1	135.6	93.8	°C/W
R <sub>θJC(top)</sub>	Junction-to-case (top) thermal resistance	0.9	N/A	66.3	N/A	°C/W
R <sub>θJB</sub>	Junction-to-board thermal resistance	39.4	N/A	24.6	N/A	°C/W
Ψ <sub>JT</sub>	Junction-to-top characterization parameter	0.2	4.1	1.6	7.9	°C/W
Ψ <sub>JB</sub>	Junction-to-board characterization parameter	39.4	62.7	24.4	39.6	°C/W

THERMAL METRIC <sup>(1)</sup>		TPS61299	TPS61299	TPS61299	TPS61299	UNIT
		YBH 6-BALLS	YBH 6-BALLS	DRL 6-PINS	DRL-6PINS	
		Standard	EVM	Standard	EVM	
R <sub>θJC(bot)</sub>	Junction-to-case (bottom) thermal resistance	N/A	N/A	N/A	N/A	°C/W

(1) For more information about traditional and new thermal metrics, see the [Semiconductor and IC Package Thermal Metrics](#) application report.

## 6.5 Electrical Characteristics

T<sub>J</sub> = -40°C to 125°C, V<sub>IN</sub> = 3.6V and V<sub>OUT</sub> = 5.0V. Typical values are at T<sub>J</sub> = 25°C, unless otherwise noted.

PARAMETER		Version	TEST CONDITIONS	MIN	TYP	MAX	UNIT
<b>POWER SUPPLY</b>							
V <sub>IN</sub>	Input voltage range	All		0.5		5.5	V
V <sub>IN_UVLO</sub>	Under-voltage lockout threshold	TPS61299, TPS61299X	V <sub>IN</sub> rising			0.7	V
V <sub>IN_UVLO</sub>	Under-voltage lockout threshold	All	V <sub>IN</sub> falling			0.5	V
I <sub>Q</sub>	Quiescent current into VIN pin	All	IC enabled, No load, No switching, T <sub>J</sub> up to 85°C		0.5		nA
I <sub>Q</sub>	Quiescent current into VOUT pin	All	IC enabled, No load, No switching, T <sub>J</sub> up to 85°C		95	300	nA
I <sub>SD</sub>	Shutdown current into VIN pin	TPS61299, TPS61299X	EN = LOW, V <sub>IN</sub> = 3.6 V, V <sub>OUT</sub> = 0 V		60		nA
I <sub>BY</sub>	Quiescent current into VIN pin at force pass through mode	TPS61299A, TPS61299XA	EN = LOW		30		nA
I <sub>LKG_SW</sub>	Leakage current into SW pin (from SW pin to VOUT pin)	All	V <sub>SW</sub> = 3.0 V, V <sub>OUT</sub> = 0 V, T <sub>J</sub> = 25°C		1	4	nA
I <sub>LKG_SW</sub>	Leakage current into SW pin (from SW pin to VOUT pin)	WCSP Package	V <sub>SW</sub> = 3.0 V, V <sub>OUT</sub> = 0 V, T <sub>J</sub> up to 85°C		1	20	nA
I <sub>LKG_SW</sub>	Leakage current into SW pin (from SW pin to GND pin)	All	V <sub>SW</sub> = 3.0 V, V <sub>OUT</sub> = 0 V, T <sub>J</sub> = 25°C		1	15	nA
I <sub>LKG_SW</sub>	Leakage current into SW pin (from SW pin to GND pin)	All	V <sub>SW</sub> = 3.0 V, V <sub>OUT</sub> = 0 V, T <sub>J</sub> up to 85°C		1	200	nA
<b>OUTPUT</b>							
V <sub>OUT</sub>	Output voltage setting range	All		1.8		5.5	V
V <sub>OUT_PWM_ACY</sub>	Output voltage accuracy	All	PWM, PFM mode	-2		2	%
V <sub>OUT_SNOOZE_ACY</sub>	Output voltage accuracy	All	normal mode			V <sub>OUT_PWM_ACY</sub> +37.5mV	V
			fast mode			V <sub>OUT_PWM_ACY</sub> +15mV	V
<b>POWER SWITCH</b>							
R <sub>DS(on)</sub>	High-side MOSFET on resistance	TPS61299X, TPS61299XA	V <sub>OUT</sub> = 5.0 V		150		mOhm
R <sub>DS(on)</sub>	Low-side MOSFET on resistance	TPS61299X, TPS61299XA	V <sub>OUT</sub> = 5.0 V		88		mOhm
I <sub>LIM</sub>	Input current limit	TPS61299, TPS61299A	V <sub>IN</sub> = 3.6 V, V <sub>OUT</sub> = 5.0 V	0.96	1.2	1.44	A
I <sub>LIM</sub>	Input current limit	TPS612994, TPS612994A	V <sub>IN</sub> = 3.6 V, V <sub>OUT</sub> = 5.0 V	80	100	120	mA
I <sub>LIM</sub>	Input current limit	TPS612997, TPS612997A	V <sub>IN</sub> = 3.6 V, V <sub>OUT</sub> = 5.0 V	1500	1900	2300	mA

**TPS61299**

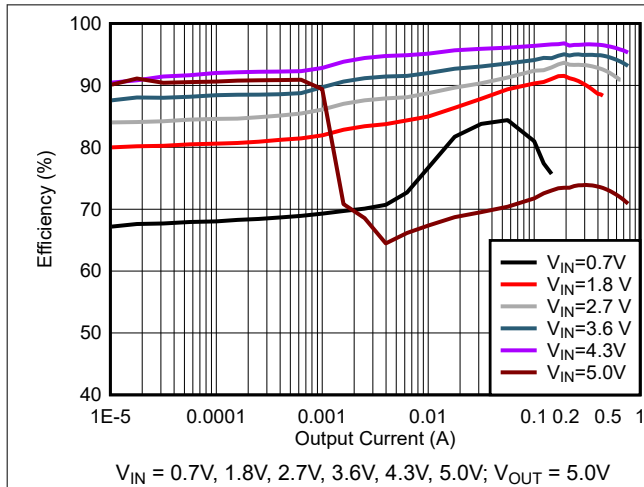
SLVSGS9D – MARCH 2023 – REVISED MARCH 2024

 $T_J = -40^{\circ}\text{C}$  to  $125^{\circ}\text{C}$ ,  $V_{IN} = 3.6\text{V}$  and  $V_{OUT} = 5.0\text{V}$ . Typical values are at  $T_J = 25^{\circ}\text{C}$ , unless otherwise noted.

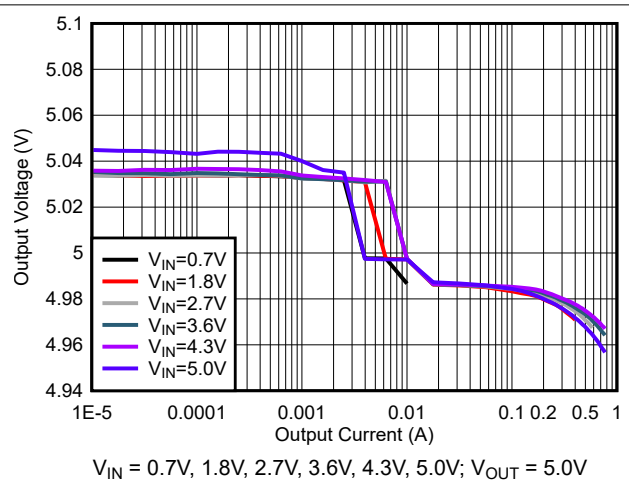
PARAMETER		Version	TEST CONDITIONS	MIN	TYP	MAX	UNIT
$I_{LH}$	Inductor current ripple	TPS61299, TPS612997	PWM		350		mA
$I_{LH}$	Inductor current ripple	TPS612994			350		mA
<b>APPLICATION</b>							
<b>LOGIC INTERFACE</b>							
$V_{EN\_H}$	EN logic high threshold	All	$V_{IN} \geq 1.05\text{ V}$			0.84	V
$V_{EN\_L}$	EN logic low threshold	All	$V_{IN} \geq 1.05\text{ V}$	0.36			V
$V_{EN\_H}$	EN logic high threshold	All	$V_{IN} < 1.05\text{ V}$			$0.8 \cdot V_{IN}$	V
$V_{EN\_L}$	EN logic low threshold	All	$V_{IN} < 1.05\text{ V}$	$0.2 \cdot V_{IN}$			V
$I_{EN\_LKG}$	Leakage current into EN pin	All	$V_{EN} = 5\text{V}$		1	50	nA
$R_{EN}$	EN pin pulldown resistor	All	EN=low		800		kOhm
<b>PROTECTION</b>							
$T_{SD}$	Thermal shutdown threshold		$T_J$ rising		150		$^{\circ}\text{C}$
$T_{SD\_HYS}$	Thermal shutdown hysteresis		$T_J$ falling below $T_{SD}$		20		$^{\circ}\text{C}$

## 6.6 Typical Characteristics

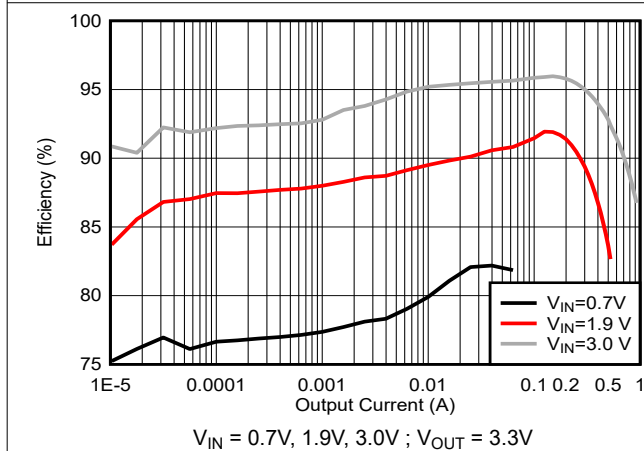
$V_{IN} = 3.6V$ ,  $V_{OUT} = 5V$ , Normal Mode,  $T_J = 25^\circ C$ , unless otherwise noted



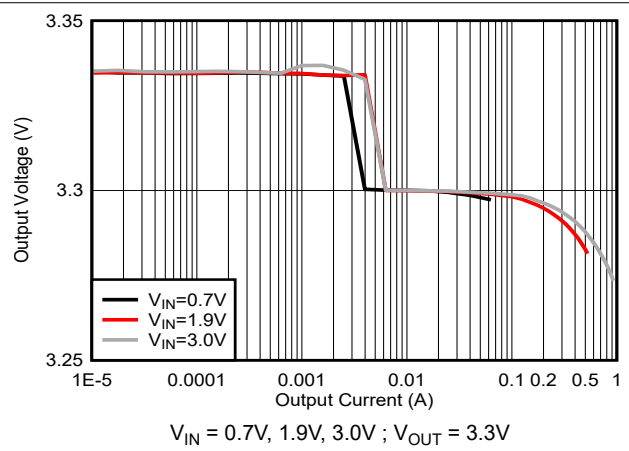
**Figure 6-1. 5.0V VOUT Efficiency with Different Inputs Under Normal Mode**



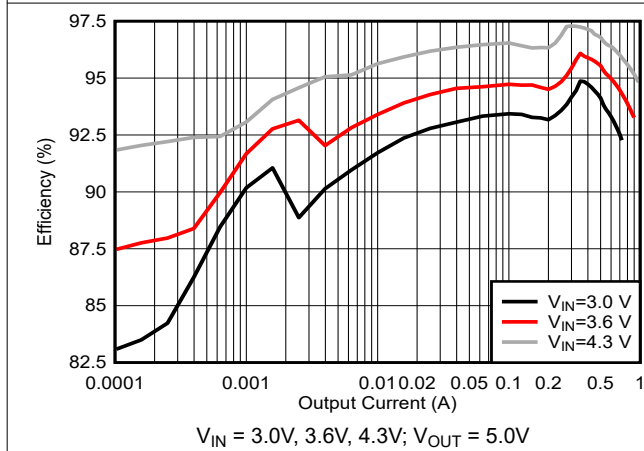
**Figure 6-2. 5.0V VOUT Load Regulation with Different Inputs Under Normal Mode**



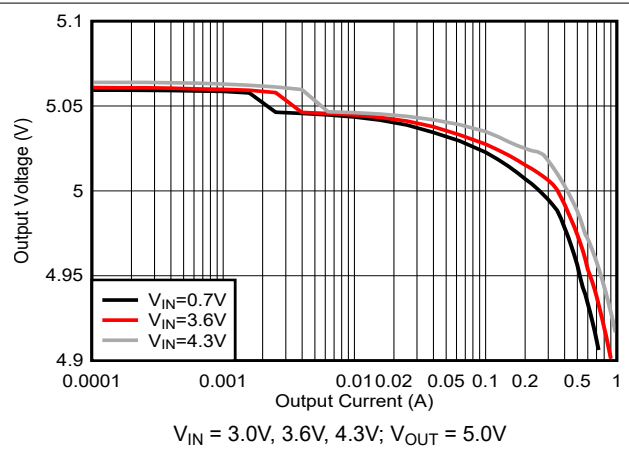
**Figure 6-3. 3.3V VOUT Efficiency with Different Inputs Under Normal Mode**



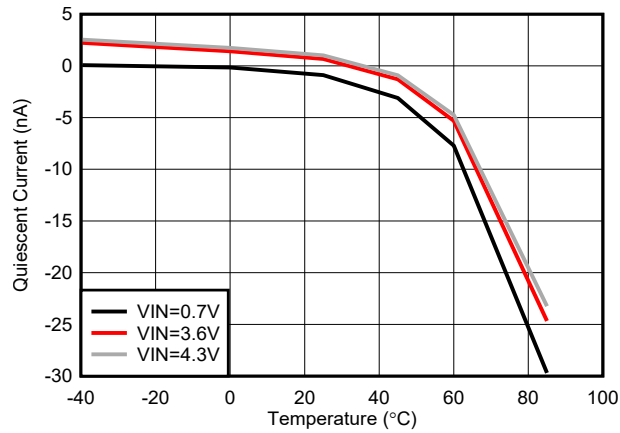
**Figure 6-4. 3.3V VOUT Load Regulation Under Normal Mode**



**Figure 6-5. 5.0V VOUT Efficiency with Different Inputs Under Fast Mode**

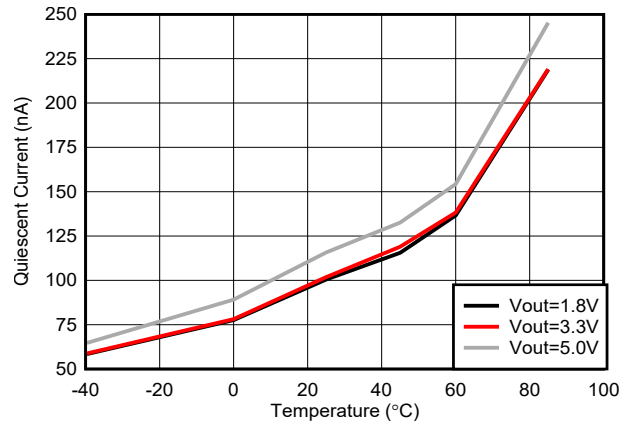


**Figure 6-6. 5.0V VOUT Load Regulation with Different Inputs Under Fast Mode**



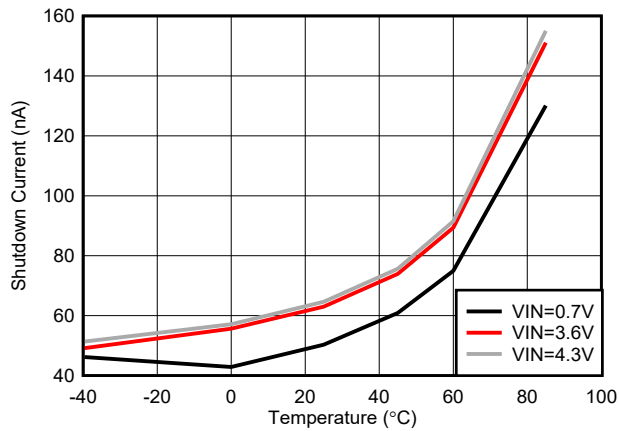
$V_{IN} = 0.7V, 3.6V, 4.3V; V_{OUT} = 5V, T_J = -40^{\circ}C \text{ to } +85^{\circ}C$ , No switching

**Figure 6-7. Quiescent Current into VIN vs Temperature**



$V_{IN} = 1.5V; V_{OUT} = 1.8V, 3.3V, 5V, T_J = -40^{\circ}C \text{ to } +85^{\circ}C$ , No switching

**Figure 6-8. Quiescent Current into VOUT vs Temperature**



$V_{IN} = 0.7V, 3.6V, 4.3V; V_{OUT} = 0V, T_J = -40^{\circ}C \text{ to } +85^{\circ}C$

**Figure 6-9. Shutdown Current vs Temperature**



## 7 Detailed Description

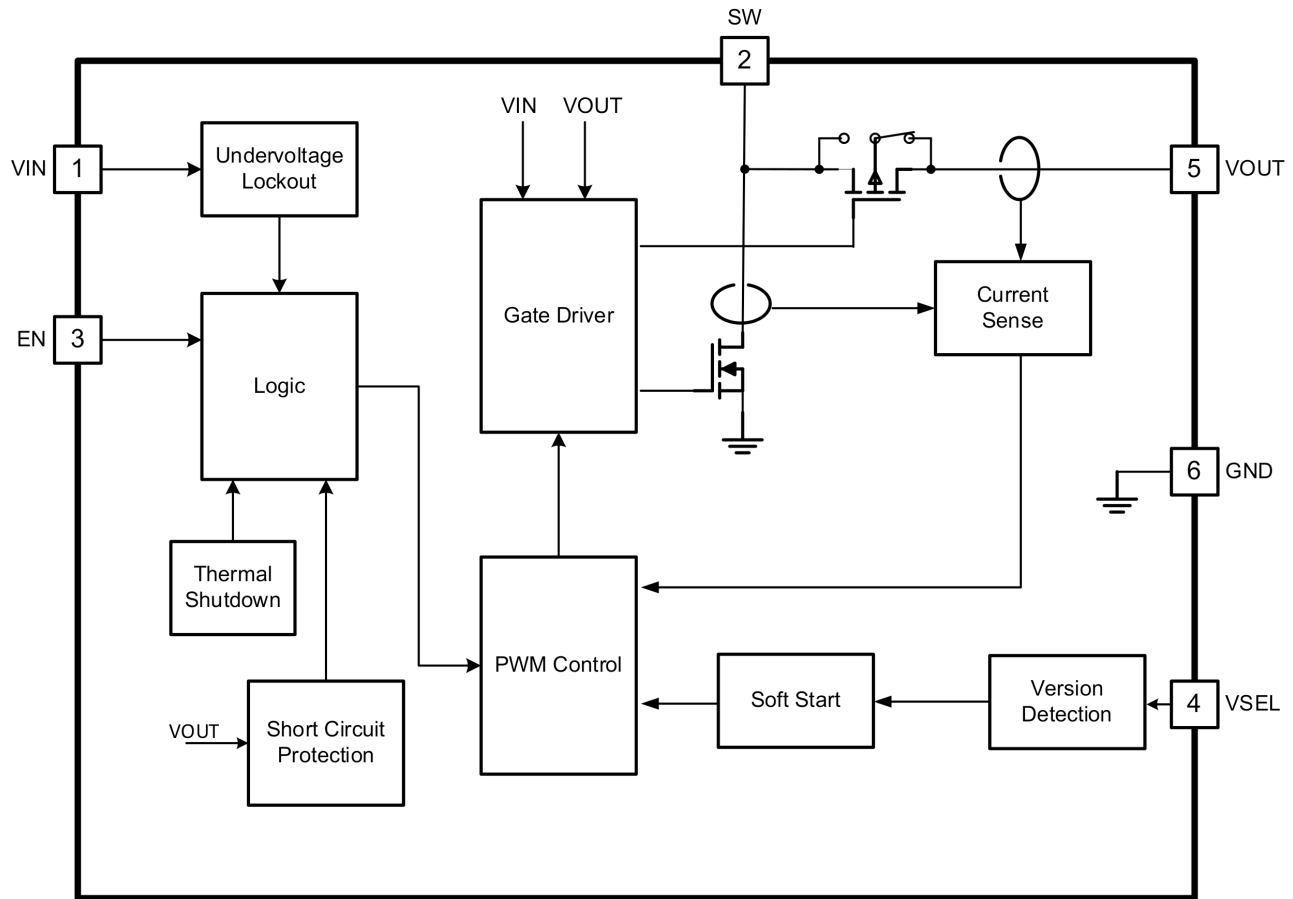
### 7.1 Overview

The TPS61299x family is a synchronous step-up converter and operates in a hysteretic control scheme. The TPS61299x family has a wide input voltage supply range between 0.5V and 5.5V ( 0.7V rising voltage for start-up). It only consumes 95nA quiescent current and can achieve up high efficiency under light load condition.

The TPS61299 family provide wide input current limit from 5 mA to 1.9 A The non-A version device supports true shutdown function and A version device supports force pass through function at EN is low.

TPS61299x family provides a fast transient performance mode and accurate load regulation mode for different system.

### 7.2 Functional Block Diagram

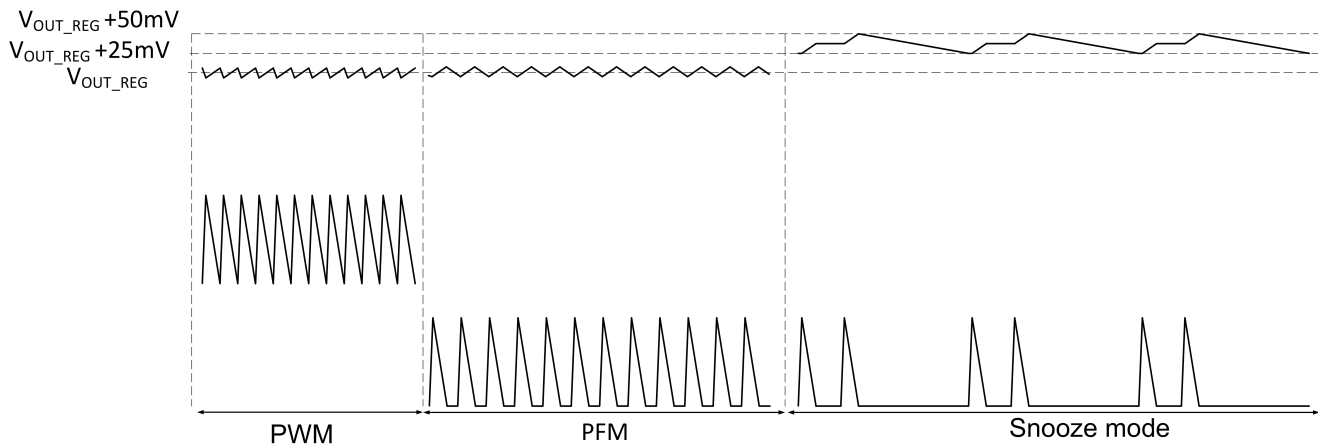


**Figure 7-1. Functional Block Diagram**

## 7.3 Feature Description

### 7.3.1 Boost Control Operation

The TPS61299x family boost converter is controlled by a hysteretic current mode controller. This controller regulates the output voltage by keeping the inductor ripple current constant in the range of 350mA and adjusting the valley current of this inductor depending on the output load. Since the input voltage, output voltage and inductor value all affect the rising and falling slopes of inductor ripple current, the switching frequency is not fixed and is determined by the operation condition. If the required average input current is lower than the average inductor current defined by this constant ripple, the inductor current goes discontinuously to keep the efficiency high under light load condition. If the load current is reduced further, the boost converter enters into Burst mode. In Burst mode, the boost converter ramps up the output voltage with several switching cycles. Once the output voltage exceeds a setting threshold ( $V_{out\_target} + 50mV$  in normal mode and  $V_{out\_target} + 25mV$  in fast load transient mode), the device stops switching and goes into a sleep status. In sleep status, the device consumes less quiescent current, 95nA. The boost converter resumes switching when the output voltage is below the setting threshold ( $V_{out\_target} + 25mV$  in normal mode and  $V_{out\_target} + 10mV$  in fast load transient mode). The device exits the Burst mode when the output current can no longer be supported in this mode.



**Figure 7-2. Control Modes under Different Load**

### 7.3.2 Version Detection

The TPS61299x family supports 21 internal output voltage setting options by connecting a resistor between the VSEL pin and ground.

During start-up, when output voltage reaches close to 1.8V, the device starts to detect the configuration conditions of the VSEL pin. The TPS61299x family checks the VSEL pin by lowering resistance setting options to higher setting options until the user finds the setting configuration by a 10µs clock. After detecting the configuration, the TPS61299x family latches the setting output regulation voltage.

The TPS61299x family does not detect the VSEL pins during operation, so changing the resistor during operation does not change the VSEL setting. Toggling the EN pin during operation is one way to refresh it.

For proper operation, TI suggests that the setting resistance accuracy must be 1% and the parasitic capacity of the VSEL pin be less than 10pF.

**Table 7-1. VSEL Pin Configuration**

Resistance (kΩ)	VOUT_REG (V)	Resistance (kΩ)	VOUT_REG (V)	Resistance (kΩ)	VOUT_REG (V)	Resistance (kΩ)	VOUT_REG (V)
0(GND)	3.3	12.1	4.5	49.9	3.6	191	2.5
3.01	5.5	14.7	4.5(fast)	75	3.5	237	2.2
4.75	5.5(fast)	18.2	4.3	100	3.2	294	2
6.19	5.2	22.6	4	124	3	365	1.8
7.87	5	28.7	3.8	154	2.8	442/ VOUT pin	5(fast)
9.76	4.8						

### 7.3.3 Under-voltage Lockout

The TPS61299x family has a built-in under-voltage lockout (UVLO) circuit to ensure the device working properly. When the input voltage is above the UVLO rising threshold of 0.7V, the TPS61299x family can be enabled to boost the output voltage. After the TPS61299x family starts up and the output voltage is above 1.8V, the TPS61299x family can work with the input voltage as low as 0.5V.

### 7.3.4 Switching Frequency

The TPS61299x family boost converter does not have fixed frequency and it maintains a constant inductor ripple current in the range of 350mA, so the frequency is determined by the operation condition. The frequency is approximately 3MHz, the input is 3.6V, output is 5V, inductor is 1µH. Refer to to calculate the efficiency. The estimated switching frequency  $f$  in continuous current mode can be calculated by [Equation 1](#). The switching frequency is not a constant value, but is determined by induction, input voltage, and output voltage.

$$f = \frac{V_{IN} \times (V_{OUT} - V_{IN} \times \eta)}{L \times I_{LH} \times V_{OUT}} \quad (1)$$

where

- L is the inductor value
- $V_{IN}$  is the input voltage
- $V_{OUT}$  is the output voltage

### 7.3.5 Input Current Limit

The TPS61299x family employs the input average current protection (OCP) function. If the inductor average current reaches the current limit threshold ILIM, the control loop can limit the inductor average current. In this case the output voltage decreases until the power balance between input and output is achieved. If the output drops below the input voltage, the TPS61299x family enters into Down Mode. If the output drops below 1.6V, the TPS61299x family enters into startup process again. In Pass-Through operation, input current limit function is not enabled.

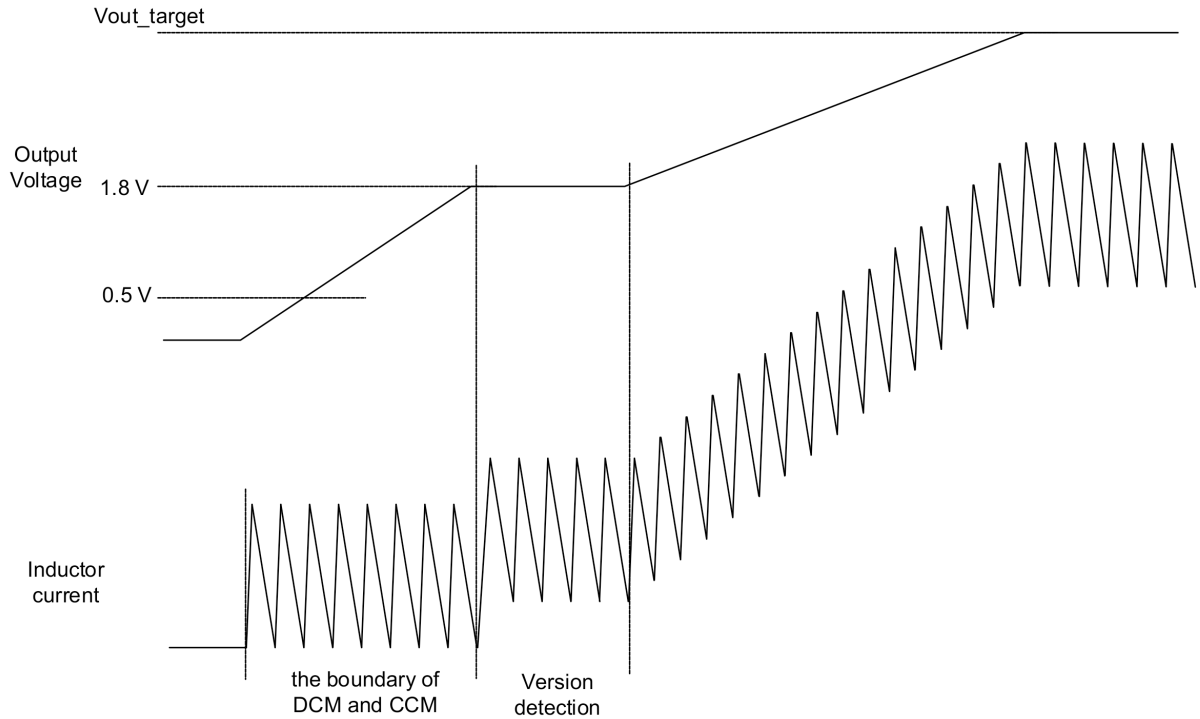
### 7.3.6 Enable and Disable

When the input voltage is above UVLO rising threshold and the EN pin is pulled to high voltage, the TPS61299x family is enabled. When the EN pin is pulled to low voltage, the none-A version device goes into true shutdown mode. In true shutdown mode, the device stops switching and the high-side MOSFET fully turns off, providing the completed disconnection between input and output. Less than 60nA input current is consumed in shutdown mode. When the EN pin is pulled to low voltage, the A version device goes into pass through mode. In pass through mode, the device stops switching and the high-side MOSFET fully turns on, providing the completed connection between input and output. Less than 30nA input current is consumed in shutdown mode.

### 7.3.7 Soft-Start Timing

After the EN pin is tied to high voltage, the TPS61299x family begins to startup.

For the high input current limit is 250mA, 500 mA, 1.2A and 1.9A version, at the beginning, when output voltage is lower than 0.5V, device limits the output power for the short protection. As output voltage is higher than 0.5V, the device operates at the boundary of Discontinuous Conduction Mode (DCM) and Continuous Conduction Mode (CCM), and the inductor peak current is limited to around 350mA during this stage. After the output voltage reaches close to 1.8V, the TPS61299x family starts to detect the output voltage configuration of the VSEL pins, then latches the configuration. The version detection time depends on the resistance at VSEL pin, the higher resistance, the longer version detection time. Eg. for 5V normal version, the TPS61299x family needs approximately 170μs for version detection. After version detection, TPS61299x family continues switching and output ramps up further. The internal soft-start time is approximately 1.3ms, and the output soft start time varies with the different output capacitance, load condition, and configuration conditions. The TPS61299x family limits the inductor average current lower than 500mA, (input current limit to 250mA for 250mA version) when output voltage is lower than 2.5V. In this way, the soft start function reduces the inrush current during startup. For the low input current limit 5mA, 25mA, 50mA and 100mA version, the device limits the input current limit to 25mA during the soft start. The device works at DCM during start up.



**Figure 7-3. Soft-Start Timing**

### 7.3.8 Down Mode

During the start-up, when the input voltage is higher than the output voltage, the TPS61299x family works at the down mode to keep the switching. In the Down Mode, the behavior of the rectifying PMOS by pulling its gate to input voltage instead of to ground. In this way, the voltage drop across the PMOS is increasing as high as to regulate the output voltage. The high side PMOS works under saturation area, thus the efficiency is much lower than boost mode. The power loss also increases in this mode, which needs to be taken into account for thermal consideration. Moreover, the current limit decreases as well under down mode, with TPS612994 decreasing by 50% and TPS61299 decreasing by 20%.

### 7.3.9 Pass-Through Operation

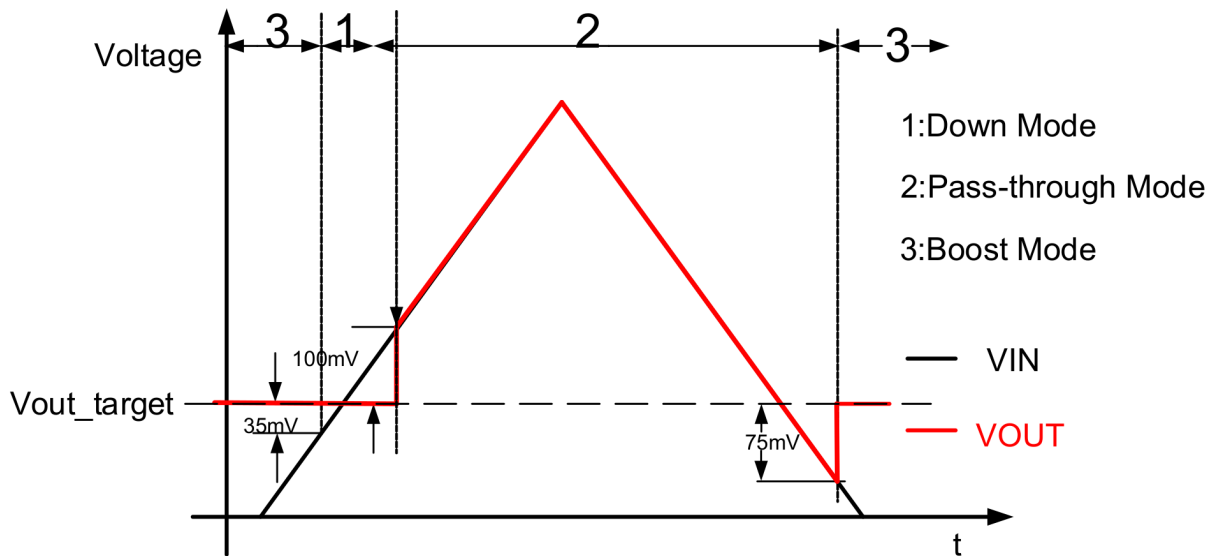
The TPS61299x family features down mode and pass-through operation when input voltage is close to or higher than output voltage.

During down mode operation, the device regulates the output voltage to the target voltage even when the input voltage is higher than the output voltage. The control circuit changes the behavior of the rectifying P-channel MOSFET by pulling its gate to input voltage instead of to ground. In this way, the voltage drop across the P-channel MOSFET is increasing as high as to regulate the output voltage.

In pass through mode, the TPS61299x family stops switching and turns on the high-side P-channel MOSFET. The output voltage is the input voltage minus the voltage drop across the DCR of the inductor and the on-resistance ( $R_{DS(on)}$ ) of the P-channel MOSFET. During pass through operation, the device disables the input current limit function, reverse current protection, and thermal shutdown.

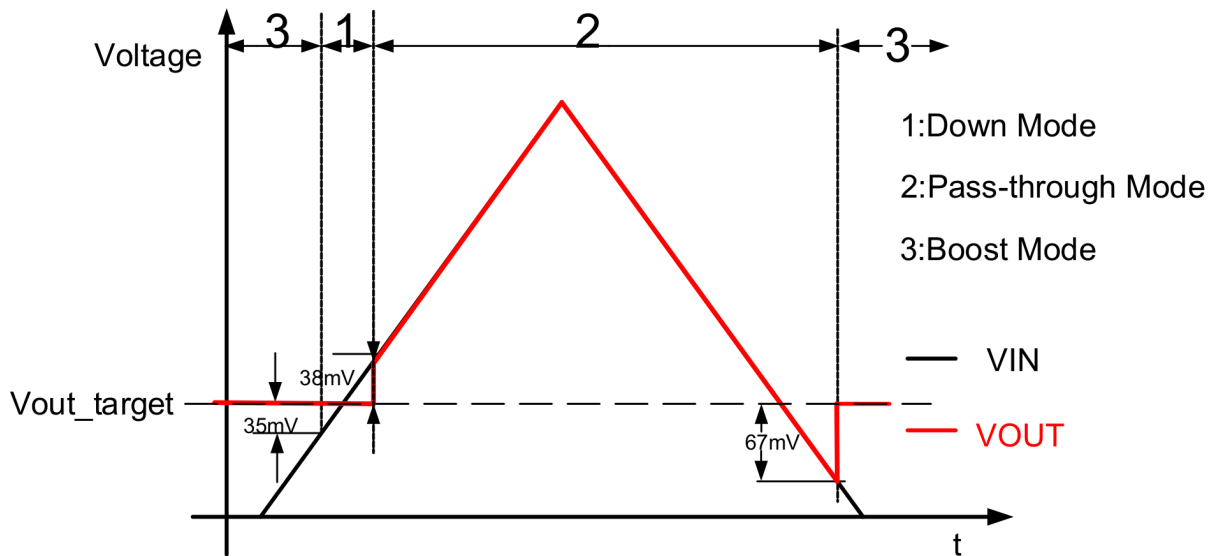
For the input current limit is equal or higher than 250mA version, TPS61299, TPS612995, TPS612996 and TPS612997. With input voltage ramping up, the device goes into down mode when  $V_{in} > V_{out} - 35mV$ . The device stays in down mode until  $V_{in} > V_{out} + 100mV$  and then goes automatically into pass through operation. In the pass through operation, output voltage follows input voltage. The TPS61299 exits pass through operation and goes back to boost mode when the output voltage drops below the setting target voltage minus 75mV.

For the input current limit equal or lower than 100mA version, TPS612991, TPS612992, TPS612993 and TPS612994. With input voltage ramping up, the device goes into down mode when  $V_{in} > V_{out} - 35mV (V_{boost\_down})$ . It stays in down mode until  $V_{in} > V_{out} + 38mV (V_{down\_pass})$  and then goes automatically into pass through operation. In the pass through operation, output voltage follows input voltage. The TPS61299X exits pass through operation and goes back to boost mode when the output voltage drops below the setting target voltage minus 67mV ( $V_{pass\_boost}$ ) device.



- A. Down mode
- B. Pass-through mode
- C. Boost mode

**Figure 7-4. Mode Transition for 250mA and Higher Input Current Limit Version**



**Figure 7-5. Mode Transition for 100mA and Lower Input Current Limit Version**

### 7.3.10 Output Short-to-Ground Protection

When the VOUT pin is short to ground and the output voltage describes to less than 0.5V, the TPS61299x family device begins to limit the inductor current, the same with soft-start operation. The TPS61299x family works at the boundary of discontinuous conduction mode (DCM) and continuous conduction mode (CCM) when the input voltage is lower than 1.8V and works at DCM at input voltage is higher than 1.8V.

After the short circuit is released, the TPS61299x family goes through the soft-start sequence again to the regulated output voltage.

### 7.3.11 Thermal Shutdown

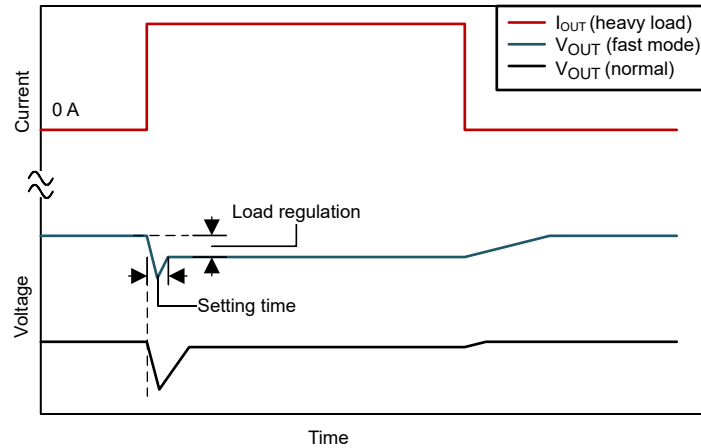
The TPS61299x family goes into thermal shutdown once the junction temperature exceeds 150°C. When the junction temperature drops below the thermal shutdown temperature threshold less the hysteresis, typically 130°C, the device starts operating again.

## 7.4 Device Functional Modes

### 7.4.1 Fast Load Transient Mode and Normal Mode

The TPS61299x family has two modes, fast load transient mode and normal mode, which is selected by VSEL pin.

In the fast load transient mode, the loop response speed is fast. Eg the load transient settling time is about 8 us when output current transient from 0A to 200mA at 3.6V to 5V condition. But the trade-off is the load regulation. Normal mode has the better load regulation.



**Figure 7-6. Transient Performance Comparison Under Fast Mode and Normal Mode**

## 8 Application and Implementation

### Note

Information in the following applications sections is not part of the TI component specification, and TI does not warrant its accuracy or completeness. TI's customers are responsible for determining suitability of components for their purposes, as well as validating and testing their design implementation to confirm system functionality.

### 8.1 Application Information

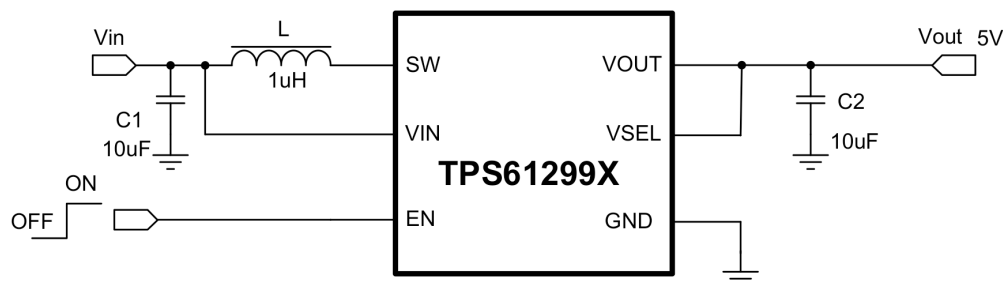
The TPS61299x family is a synchronous step-up converter and operates in a hysteretic control scheme. The TPS61299x family has a wide input voltage supply range between 0.5V and 5.5V(0.7V rising voltage for start up). The device only consumes 95nA quiescent current and can achieve up high efficiency under light load condition.

The TPS61299 family provide wide input current limit from 5mA to 1.9A and support optional true shutdown function or force pass through function at EN is low.

TPS61299x family provides a fast transient performance mode and accurate load regulation mode for different system.

### 8.2 Typical Application-Li-ion Battery to 5V Boost Converter Under Fast Mode

The TPS61299x family can operate under fast transient mode with 8μs settling time under 0 to 200mA load step. Set the VSEL according to [Table 8-1](#) to select different target VOUT under fast mode.



**Figure 8-1. 3.6V Input Source to 5V Boost Converter Under Fast Mode**



## 8.2.1 Design Requirements

The design parameters are listed in [Table 8-1](#).

**Table 8-1. Design Requirements**

PARAMETERS	VALUES
Input Voltage	2.7V ~ 4.3V
Output Voltage	5V ( fast mode )
Output Current	500mA
Output Voltage Ripple	± 50mV

## 8.2.2 Detailed Design Procedure

### 8.2.2.1 Maximum Output Current

The maximum output capability of the TPS61299x family is determined by the input-to-output ratio and the current limit of the boost converter. The maximum output current can be estimated by [Equation 2](#).

$$I_{OUT(max)} = \frac{V_{IN} I_{LIM}}{V_{OUT}} \eta \quad (2)$$

where

- $\eta$  is the conversion efficiency, use 85% for estimation.
- $I_{LIM}$  is the average switch current limit.

Minimum input voltage, maximum boost output voltage, and minimum current limit  $I_{LIM}$  are used as the worst case condition for the estimation.

### 8.2.2.2 Inductor Selection

The TPS61299x family boost converter does not have fixed frequency and it keeps the inductor ripple current constant in the range of 350mA, so the frequency is determined by the inductance and working voltage.

The TPS61299x family is designed to work with inductor value of 1 $\mu$ H.

**Table 8-2. Recommended Inductors for the TPS61299x family**

PART NUMBER	L ( $\mu$ H)	DCR MAX (m $\Omega$ )	SATURATION CURRENT (A)	SIZE (LxWxH)	VENDOR <sup>(1)</sup>
HTTH16080H-1R0MSR-99	1	110	2.3	1.6 × 0.8 × 0.8	Cyntec
WIP252010P-1R0ML	1	54	3.5	2.5 × 2.0 × 1.0	INPAQ
WPN252010H1R0MT	1	76	3.5	2.5 × 2.0 × 1.0	Sunlord

(1) See the Third-Party Products disclaimer

### 8.2.2.3 Output Capacitor Selection

The output capacitor is mainly selected to meet the requirements for output ripple and loop stability. The ripple voltage is related to capacitor capacitance and its equivalent series resistance (ESR). Assuming a ceramic capacitor with zero ESR, the minimum capacitance needed for a given ripple voltage can be calculated by Equation 3.

$$C_{OUT} = \frac{I_{OUT} \times D_{MAX}}{f_{SW} \times V_{RIPPLE}} \quad (3)$$

where

- $D_{MAX}$  is the maximum switching duty cycle.
- $V_{RIPPLE}$  is the peak-to-peak output ripple voltage.
- $I_{OUT}$  is the maximum output current.
- $f_{SW}$  is the switching frequency.

The ESR impact on the output ripple must be considered if tantalum or aluminum electrolytic capacitors are used. The output peak-to-peak ripple voltage caused by the ESR of the output capacitors can be calculated by Equation 4.

$$V_{RIPPLE(ESR)} = I_{L(P)} \times R_{ESR} \quad (4)$$

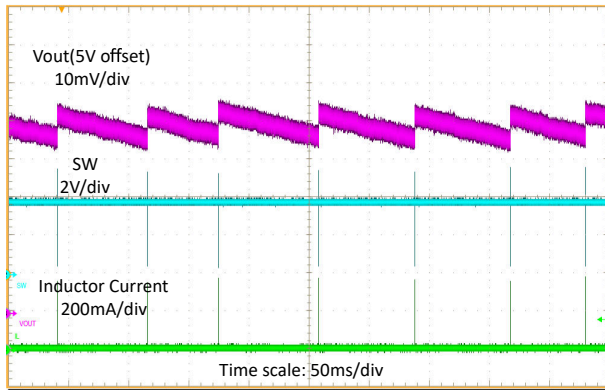
Take care when evaluating the derating of a ceramic capacitor under DC bias voltage, aging, and AC signal. For example, the DC bias voltage can significantly reduce capacitance. A ceramic capacitor can lose more than 50% of its capacitance at its rated voltage. Therefore, always leave margin on the voltage rating to make sure there is adequate capacitance at the required output voltage. Increasing the output capacitor makes the output ripple voltage smaller in PWM mode.

TI recommends using the X5R or X7R ceramic output capacitor in the range of 4 $\mu$ F to 1000 $\mu$ F effective capacitance. The output capacitor affects the small signal control loop stability of the boost regulator. Effective output capacitance should be no less than 20 $\mu$ F as soon as output current is higher than 1A or the TPS612997, the 1.9A input current limit version device is used. If the output capacitor is below the range, the boost regulator can potentially become unstable.

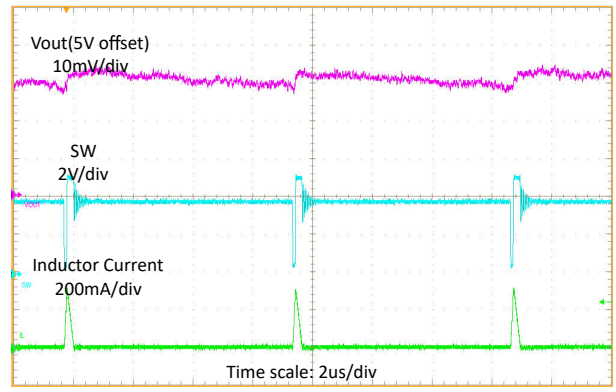
### 8.2.2.4 Input Capacitor Selection

Multilayer X5R or X7R ceramic capacitors are excellent choices for the input decoupling of the step-up converter as they have extremely low ESR and are available in small footprints. Input capacitors must be located as close as possible to the device. While a 10 $\mu$ F input capacitor is sufficient for most applications, larger values can be used to reduce input current ripple without limitations. Take care when using only ceramic input capacitors. When a ceramic capacitor is used at the input and the power is being supplied through long wires, a load step at the output can induce ringing at the VIN pin. This ringing can couple to the output and be mistaken as loop instability or can even damage the part. In this circumstance, place additional bulk capacitance (tantalum or aluminum electrolytic capacitor) between ceramic input capacitor and the power source to reduce ringing that can occur between the inductance of the power source leads and ceramic input capacitor.

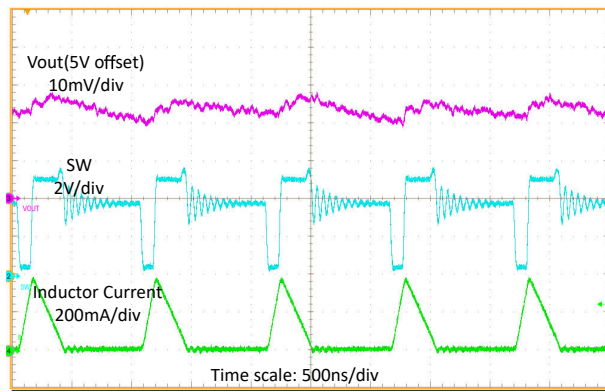
### 8.2.3 Application Curves



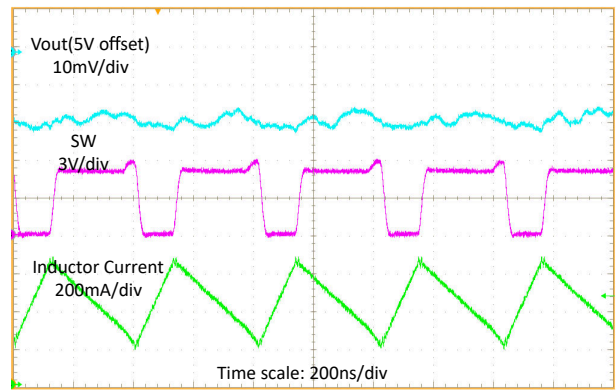
$V_{IN} = 3.6V$        $I_{OUT} = 0A$   
**Figure 8-2. Switching Waveform at Open Load**



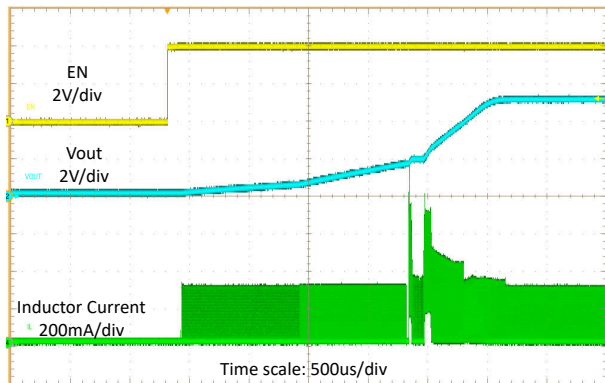
$V_{IN} = 3.6V$        $I_{OUT} = 5mA$   
**Figure 8-3. Switching Waveform at Light Load**



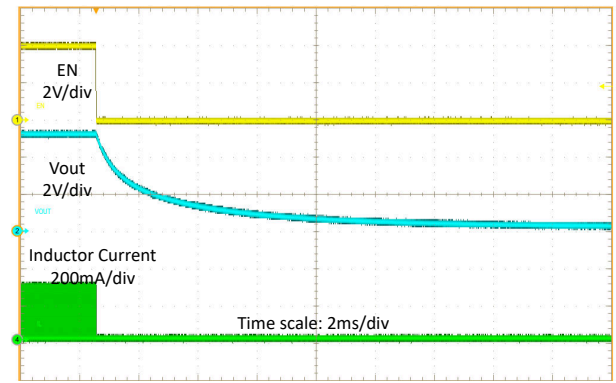
$V_{IN} = 3.6V$        $I_{OUT} = 50mA$   
**Figure 8-4. Switching Waveform at Medium Load**



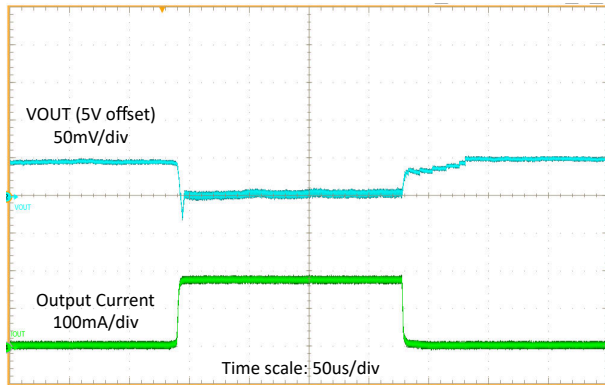
$V_{IN} = 3.6V$        $I_{OUT} = 300mA$   
**Figure 8-5. Switching Waveform at Heavy Load**



$V_{IN} = 3.6V$        $V_{OUT} = 5V$        $R_{load} = 500\Omega$   
**Figure 8-6. Start-Up by EN**

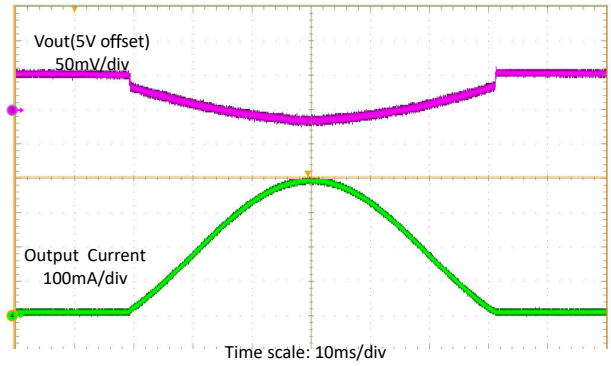


$V_{IN} = 3.6V$        $V_{OUT} = 5V$        $R_{load} = 500\Omega$   
**Figure 8-7. Shutdown by EN**



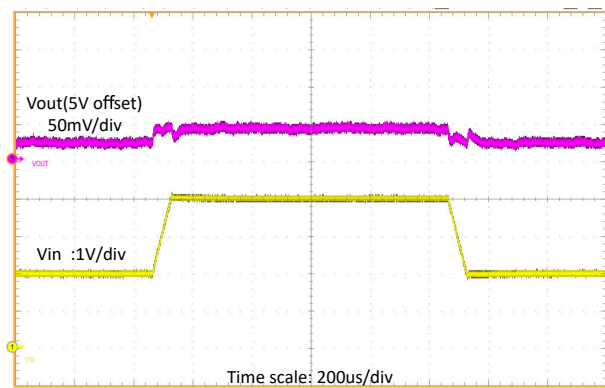
$V_{IN} = 3.6V$ ,  $V_{OUT} = 5V$ ,  $I_{OUT} = 0$  to  $200mA$  with  $20\text{-}\mu s$  slew rate

**Figure 8-8. Load Transient**



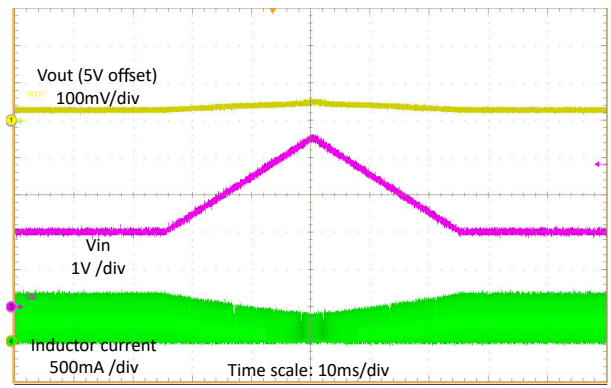
$V_{IN} = 3.6V$ ,  $V_{OUT} = 5V$ ,  $I_{OUT} = 0$  to  $400mA$  sweep

**Figure 8-9. Load Sweep**



$V_{IN} = 2V$  to  $4V$  with  $20\text{-}\mu s$  slew rate,  $V_{OUT} = 5V$ ,  $R_{load} = 50\Omega$

**Figure 8-10. Line Transient**

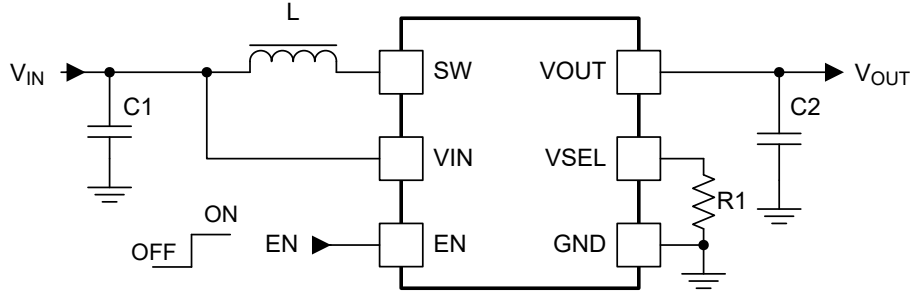


$V_{IN} = 2V$  to  $4.5V$  Sweep,  $V_{OUT} = 5V$ ,  $R_{load} = 25\Omega$

**Figure 8-11. Line Sweep**

### 8.3 Typical Application-Li-ion Battery to 5V Boost Converter Under Normal Mode

The TPS61299x family can also operate under normal mode with slightly slower transient performance than fast mode. Set the VSEL according to [Table 8-3](#) to select different target output voltage during fast mode operation. [Table 8-3](#) lists the design parameters.



**Figure 8-12. 3.6V Input Source to 5V Boost Converter Under Normal Mode**

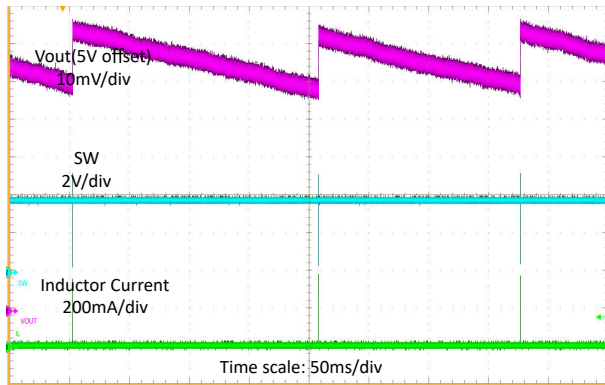
#### 8.3.1 Design Requirements

The design parameters are listed in [Table 8-1](#).

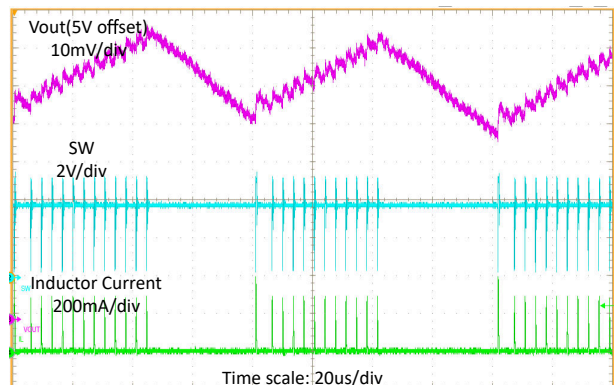
**Table 8-3. Design Requirements**

PARAMETERS	VALUES
Input Voltage	2.7V ~ 4.3V
Output Voltage	5V ( normal mode )
Output Current	10mA
Output Voltage Ripple	± 50mV

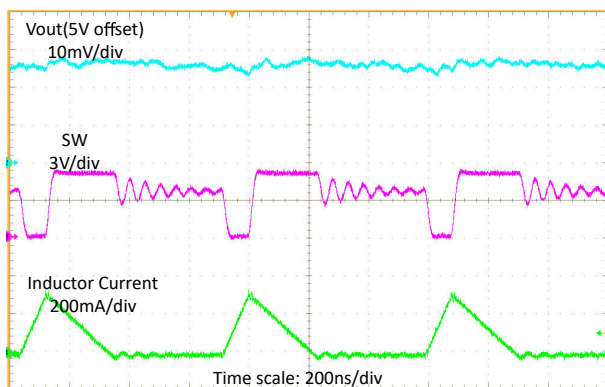
### 8.3.2 Application Curves



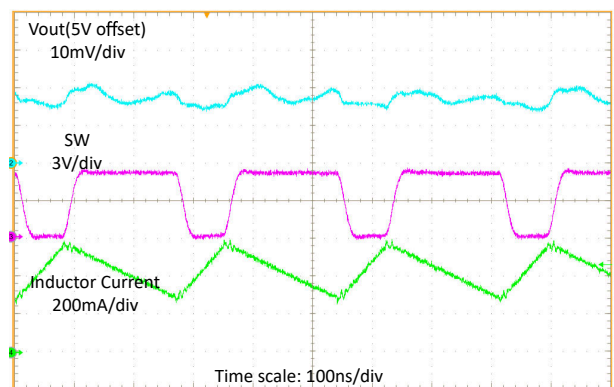
**Figure 8-13. Switching Waveform at Open Load**



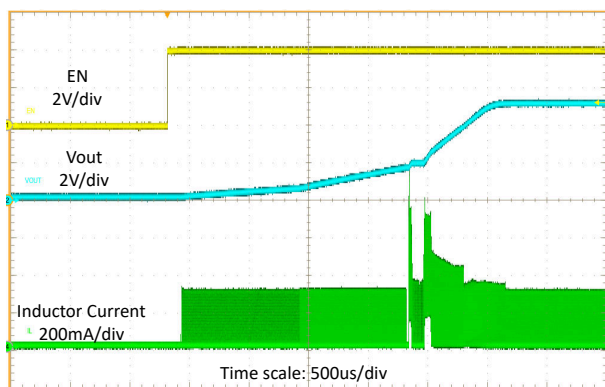
**Figure 8-14. Switching Waveform at Light Load**



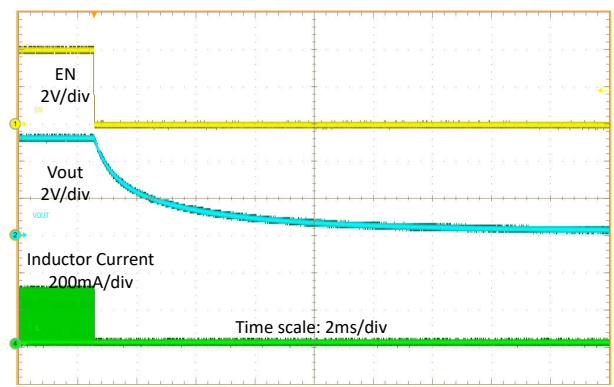
**Figure 8-15. Switching Waveform at Medium Load**



**Figure 8-16. Switching Waveform at Heavy Load**

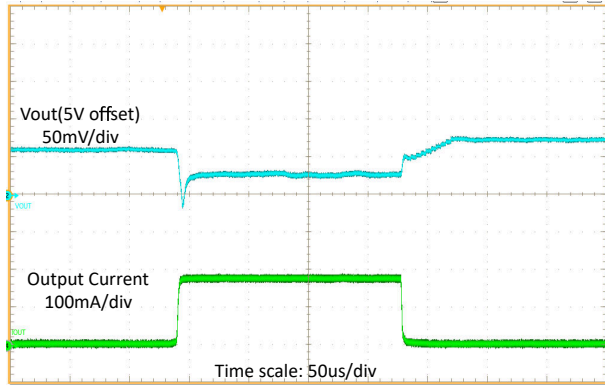


**Figure 8-17. Start-Up by EN**



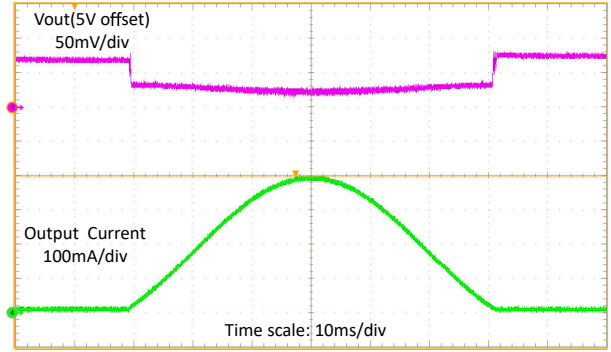
**Figure 8-18. Shutdown by EN**





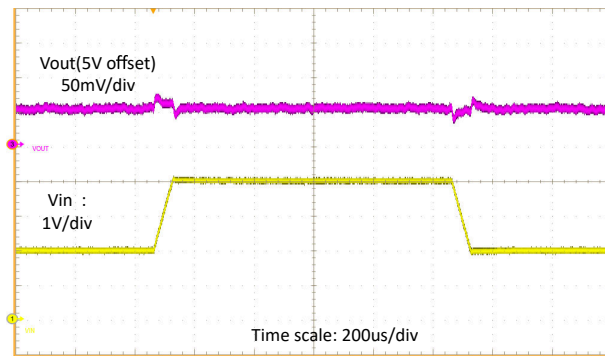
$V_{IN} = 3.6V$ ,  $V_{OUT} = 5V$ ,  $I_{OUT} = 0$  to  $200mA$  with  $20\text{-}\mu s$  slew rate

**Figure 8-19. Load Transient**



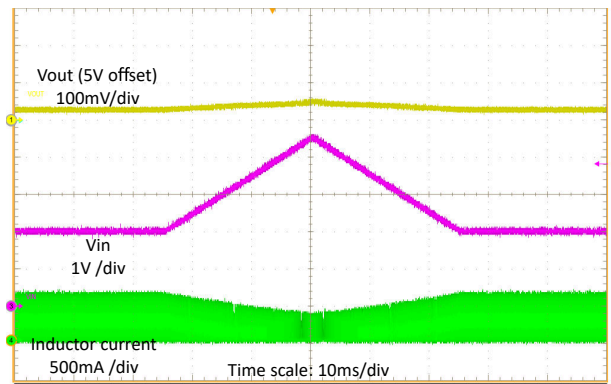
$V_{IN} = 3.6V$ ,  $V_{OUT} = 5V$ ,  $I_{OUT} = 0$  to  $400mA$  sweep

**Figure 8-20. Load Sweep**



$V_{IN} = 2V$  to  $4V$  with  $20\text{-}\mu s$  slew rate,  $V_{OUT} = 5V$ ,  $R_{load} = 50\Omega$

**Figure 8-21. Line Transient**



$V_{IN} = 2V$  to  $4.5V$  Sweep,  $V_{OUT} = 5V$ ,  $R_{load} = 25\Omega$

**Figure 8-22. Line Sweep**

## 8.4 Power Supply Recommendations

The device is designed to operate from an input voltage supply range between 0.7V to 5.5V. This input supply must be well regulated. If the input supply is located more than a few inches from the converter, additional bulk capacitance can be required in addition to the ceramic bypass capacitors. A typical choice is a tantalum or aluminum electrolytic capacitor with a value of 100 $\mu$ F. Output current of the input power supply must be rated according to the supply voltage, output voltage, and output current of the TPS61299x family.

## 8.5 Layout

### 8.5.1 Layout Guidelines

As for all switching power supplies, the layout is an important step in the design, especially at high peak currents and high switching frequencies. If the layout is not carefully done, the regulator can show stability problems as well as EMI problems. Therefore, use wide and short traces for the main current path and for the power ground paths. The input and output capacitors, as well as the inductor are placed as close as possible to the device.

### 8.5.2 Layout Example

The bottom layer is a large GND plane connected by vias.

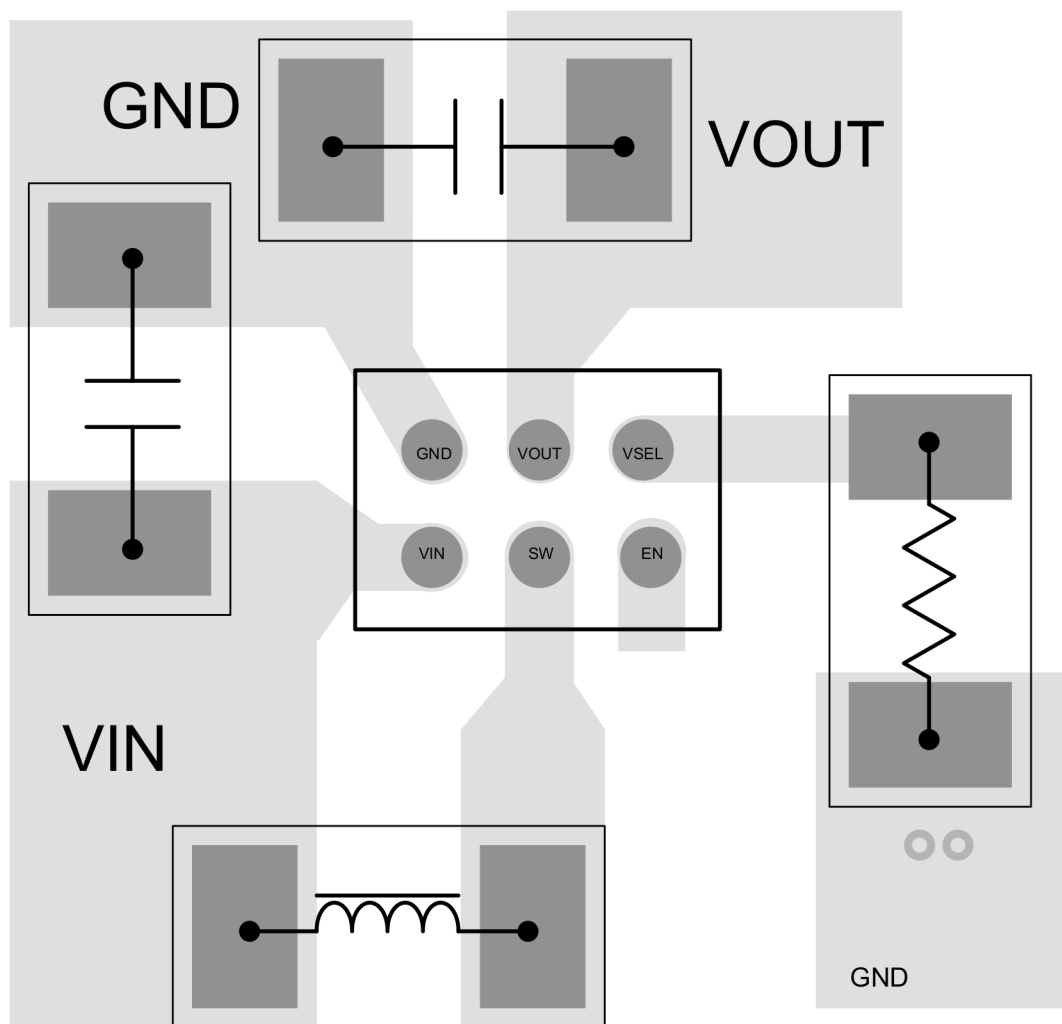


Figure 8-23. Layout Example-YBH



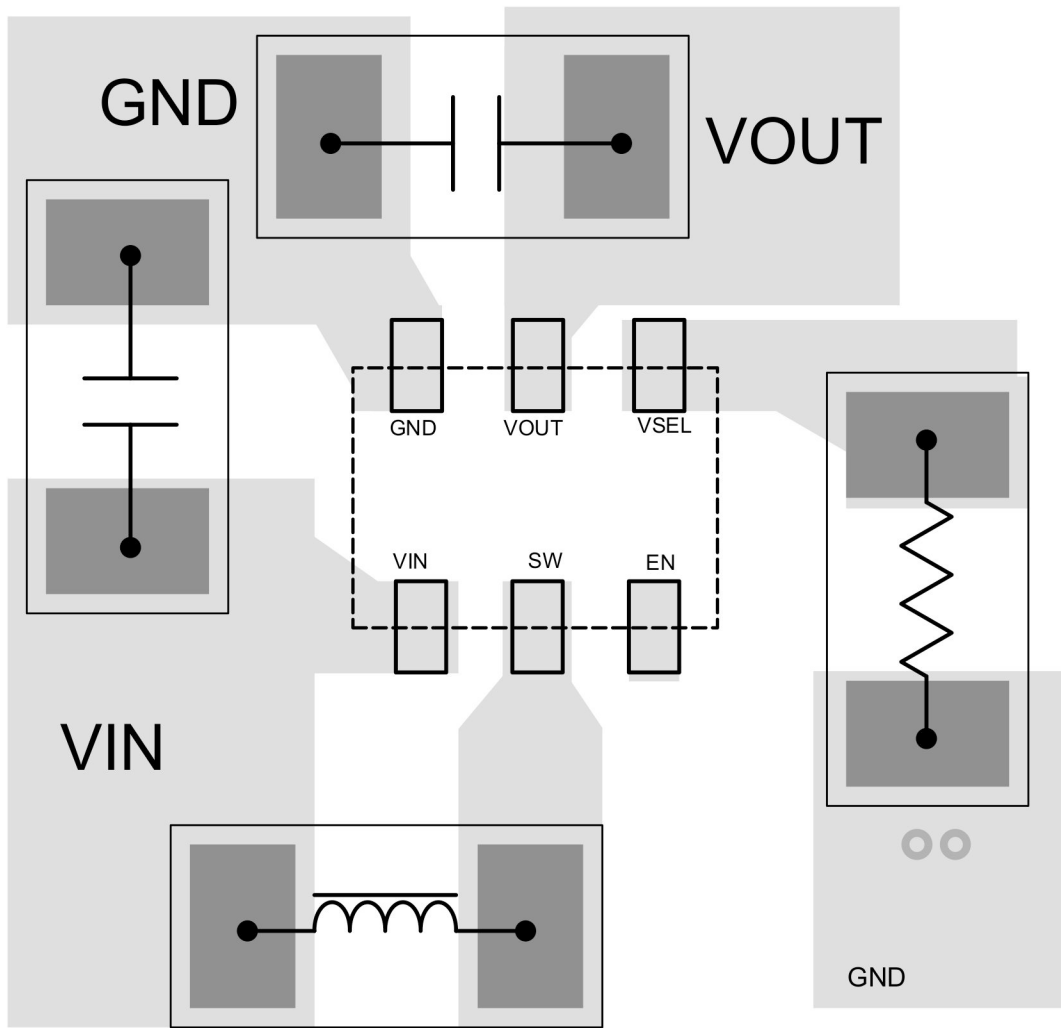


Figure 8-24. Layout Example-DRL

## 8.6 Thermal Information

The maximum junction temperature is restricted to 125°C under normal operating conditions. Calculate the maximum allowable dissipation,  $P_{D(max)}$ , and maintain the actual power dissipation less than or equal to  $P_{D(max)}$ . The maximum-power-dissipation limit is determined using [Equation 5](#).

$$P_{D(max)} = \frac{125 - T_A}{R_{\theta JA}} \quad (5)$$

where

- $T_A$  is the maximum ambient temperature for the application
- $\Theta_{JA}$  is the junction-to-ambient thermal resistance given in the Thermal Information table.

The TPS61299x family comes in a WCSP or SOT583 package. The real junction-to-ambient thermal resistance of the package greatly depends on the PCB type and layout. Using thick PCB copper and soldering GND pin to

a large ground plate enhances the thermal performance. Using more vias connects the ground plate on the top layer and bottom layer around the IC without solder mask also improves the thermal capability.

## 9 Device and Documentation Support

### 9.1 Device Support

#### 9.1.1 Third-Party Products Disclaimer

TI'S PUBLICATION OF INFORMATION REGARDING THIRD-PARTY PRODUCTS OR SERVICES DOES NOT CONSTITUTE AN ENDORSEMENT REGARDING THE SUITABILITY OF SUCH PRODUCTS OR SERVICES OR A WARRANTY, REPRESENTATION OR ENDORSEMENT OF SUCH PRODUCTS OR SERVICES, EITHER ALONE OR IN COMBINATION WITH ANY TI PRODUCT OR SERVICE.

### 9.2 Documentation Support

#### 9.2.1 Related Documentation

For related documentation see the following:

- Texas Instruments, [Performing Accurate PFM Mode Efficiency Measurements Application Report](#)
- Texas Instruments, [Accurately Measuring Efficiency of Ultra-low-IQ Devices Technical Brief](#)
- Texas Instruments, [IQ: What it is, What it isn't, and How to Use it Technical Brief](#)

### 9.3 Receiving Notification of Documentation Updates

To receive notification of documentation updates, navigate to the device product folder on [ti.com](#). Click on *Notifications* to register and receive a weekly digest of any product information that has changed. For change details, review the revision history included in any revised document.

### 9.4 Support Resources

[TI E2E™ support forums](#) are an engineer's go-to source for fast, verified answers and design help — straight from the experts. Search existing answers or ask your own question to get the quick design help you need.

Linked content is provided "AS IS" by the respective contributors. They do not constitute TI specifications and do not necessarily reflect TI's views; see TI's [Terms of Use](#).

### 9.5 Trademarks

TI E2E™ is a trademark of Texas Instruments.

All trademarks are the property of their respective owners.

### 9.6 Electrostatic Discharge Caution



This integrated circuit can be damaged by ESD. Texas Instruments recommends that all integrated circuits be handled with appropriate precautions. Failure to observe proper handling and installation procedures can cause damage.

ESD damage can range from subtle performance degradation to complete device failure. Precision integrated circuits may be more susceptible to damage because very small parametric changes could cause the device not to meet its published specifications.

### 9.7 Glossary

[TI Glossary](#) This glossary lists and explains terms, acronyms, and definitions.

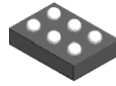
## 10 Revision History

NOTE: Page numbers for previous revisions may differ from page numbers in the current version.

<b>Changes from Revision C (February 2024) to Revision D (March 2024)</b>	<b>Page</b>
<ul style="list-style-type: none"> <li>• Updated the title of Figure 6-2.....7</li> <li>• Updated equation.....11</li> </ul>	7 11
<b>Changes from Revision B (August 2023) to Revision C (February 2024)</b>	<b>Page</b>
<ul style="list-style-type: none"> <li>• Updated mechanical packaging information. ....1</li> </ul>	1
<b>Changes from Revision A (June 2023) to Revision B (August 2023)</b>	<b>Page</b>
<ul style="list-style-type: none"> <li>• Changed document status from Advance Information to Production Data.....1</li> </ul>	1
<b>Changes from Revision * (March 2023) to Revision A (June 2023)</b>	<b>Page</b>
<ul style="list-style-type: none"> <li>• Updated Electrical Characteristics Iq from 100 nA to 95 nA ..... 4</li> </ul>	4

## 11 Mechanical, Packaging, and Orderable Information

The following pages include mechanical packaging and orderable information. This information is the most current data available for the designated devices. This data is subject to change without notice and revision of this document. For browser-based versions of this data sheet, refer to the left-hand navigation.

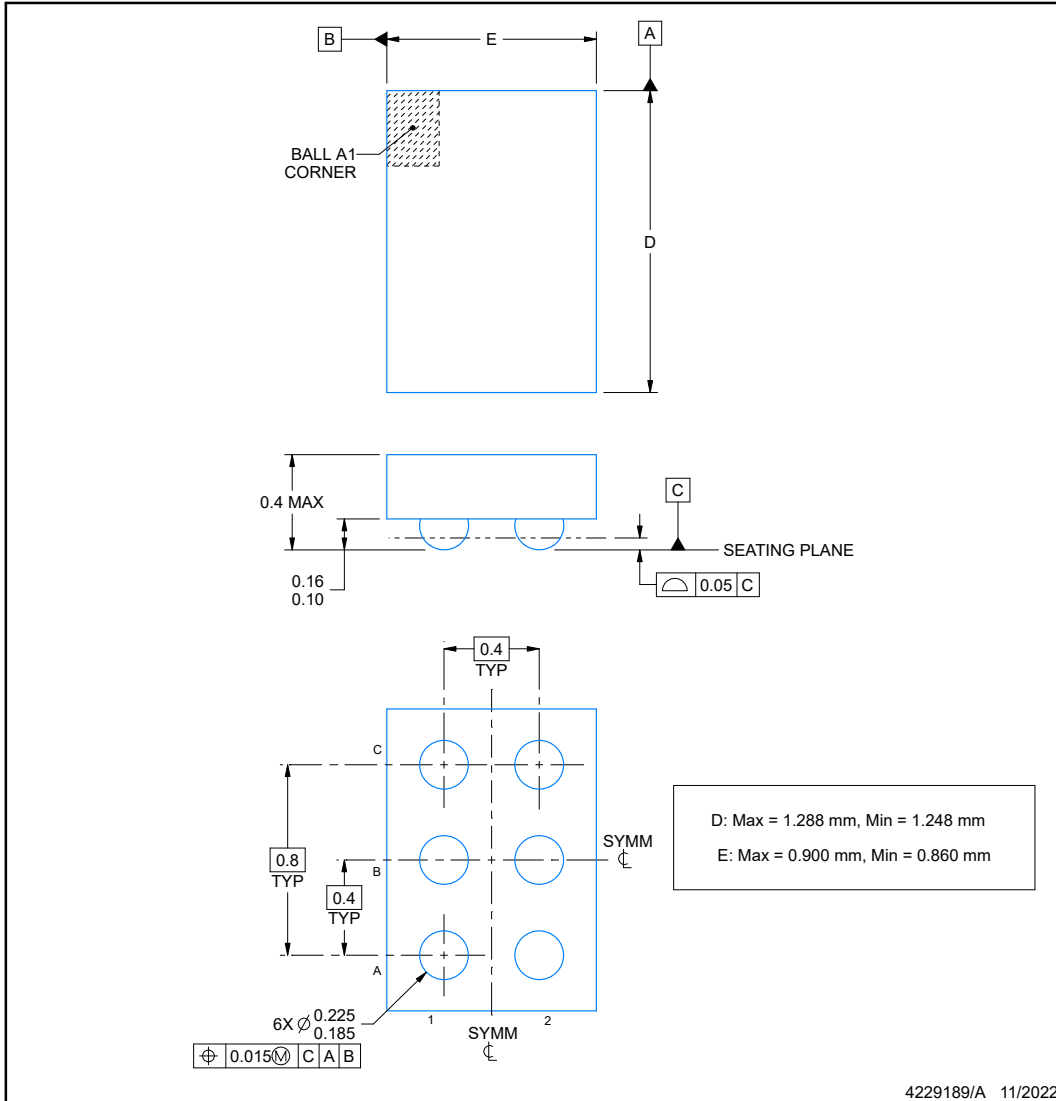


**YBH0006-C03**

**PACKAGE OUTLINE**

**DSBGA - 0.4 mm max height**

DIE SIZE BALL GRID ARRAY



NOTES:

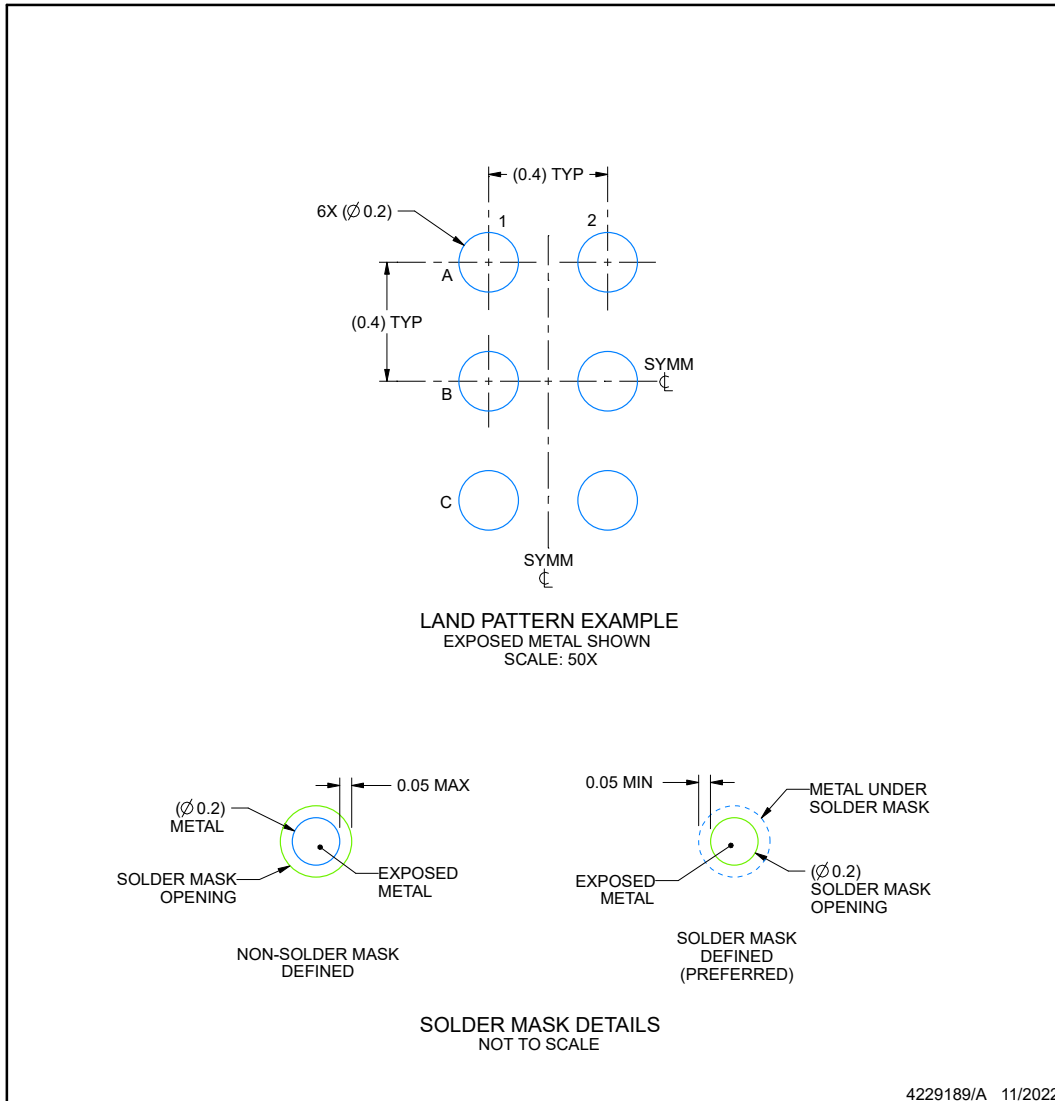
1. All linear dimensions are in millimeters. Any dimensions in parenthesis are for reference only. Dimensioning and tolerancing per ASME Y14.5M.
2. This drawing is subject to change without notice.

## EXAMPLE BOARD LAYOUT

**YBH0006-C03**

**DSBGA - 0.4 mm max height**

DIE SIZE BALL GRID ARRAY



NOTES: (continued)

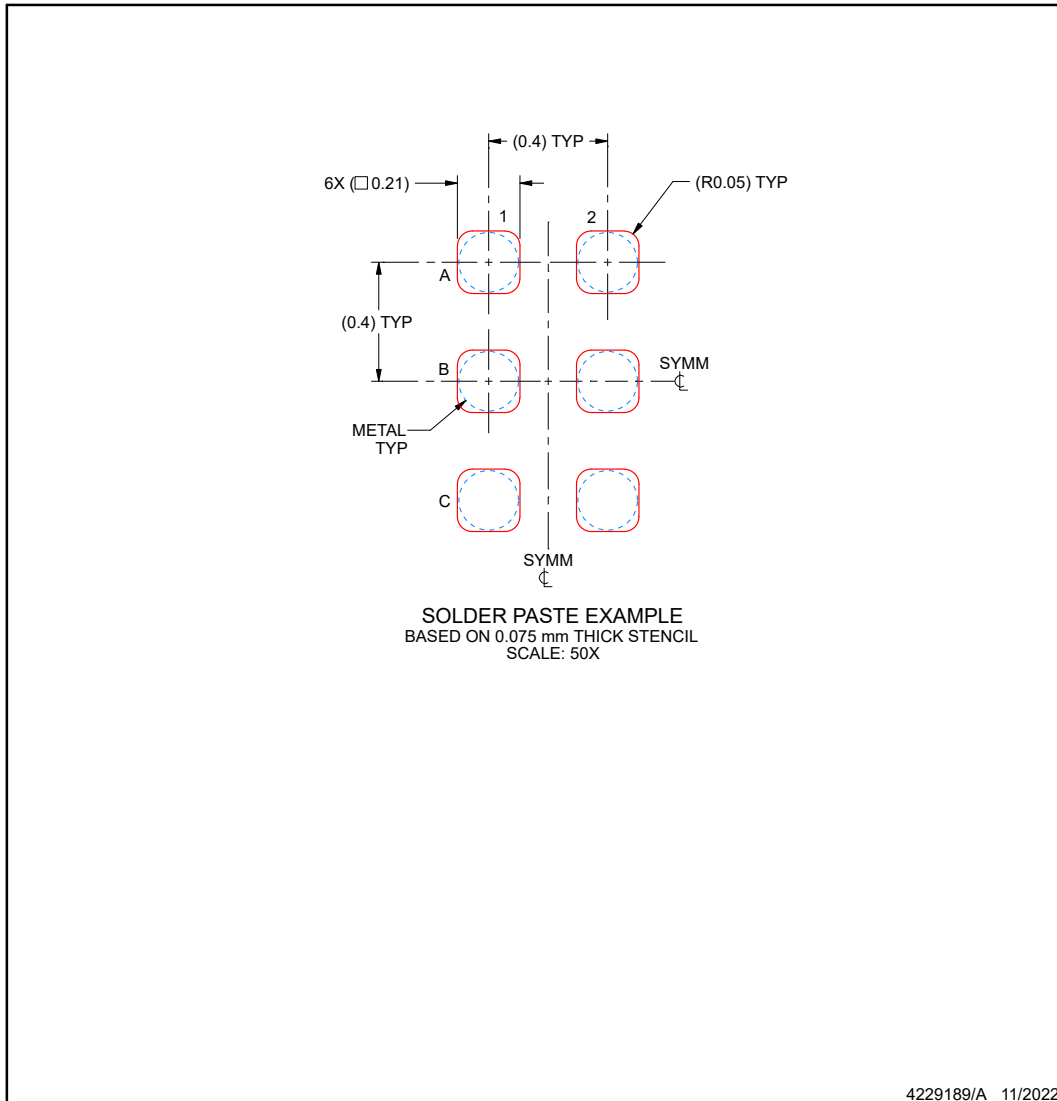
- Final dimensions may vary due to manufacturing tolerance considerations and also routing constraints. See Texas Instruments Literature No. SNVA009 ([www.ti.com/lit/snva009](http://www.ti.com/lit/snva009)).

## EXAMPLE STENCIL DESIGN

**YBH0006-C03**

**DSBGA - 0.4 mm max height**

DIE SIZE BALL GRID ARRAY



NOTES: (continued)

4. Laser cutting apertures with trapezoidal walls and rounded corners may offer better paste release.

**PACKAGING INFORMATION**

Orderable Device	Status (1)	Package Type	Package Drawing	Pins	Package Qty	Eco Plan (2)	Lead finish/ Ball material (6)	MSL Peak Temp (3)	Op Temp (°C)	Device Marking (4/5)	Samples
TPS612994YBHR	ACTIVE	DSBGA	YBH	6	6000	RoHS & Green	SNAGCU	Level-1-260C-UNLIM	-40 to 125	994	<a href="#">Samples</a>
TPS612997YBHR	ACTIVE	DSBGA	YBH	6	6000	RoHS & Green	SNAGCU	Level-1-260C-UNLIM		997	<a href="#">Samples</a>
TPS61299YBHR	ACTIVE	DSBGA	YBH	6	6000	RoHS & Green	SNAGCU	Level-1-260C-UNLIM	-40 to 125	299	<a href="#">Samples</a>

(1) The marketing status values are defined as follows:

**ACTIVE:** Product device recommended for new designs.

**LIFEBUY:** TI has announced that the device will be discontinued, and a lifetime-buy period is in effect.

**NRND:** Not recommended for new designs. Device is in production to support existing customers, but TI does not recommend using this part in a new design.

**PREVIEW:** Device has been announced but is not in production. Samples may or may not be available.

**OBSOLETE:** TI has discontinued the production of the device.

(2) **RoHS:** TI defines "RoHS" to mean semiconductor products that are compliant with the current EU RoHS requirements for all 10 RoHS substances, including the requirement that RoHS substance do not exceed 0.1% by weight in homogeneous materials. Where designed to be soldered at high temperatures, "RoHS" products are suitable for use in specified lead-free processes. TI may reference these types of products as "Pb-Free".

**RoHS Exempt:** TI defines "RoHS Exempt" to mean products that contain lead but are compliant with EU RoHS pursuant to a specific EU RoHS exemption.

**Green:** TI defines "Green" to mean the content of Chlorine (Cl) and Bromine (Br) based flame retardants meet JS709B low halogen requirements of <=1000ppm threshold. Antimony trioxide based flame retardants must also meet the <=1000ppm threshold requirement.

(3) MSL, Peak Temp. - The Moisture Sensitivity Level rating according to the JEDEC industry standard classifications, and peak solder temperature.

(4) There may be additional marking, which relates to the logo, the lot trace code information, or the environmental category on the device.

(5) Multiple Device Markings will be inside parentheses. Only one Device Marking contained in parentheses and separated by a "~" will appear on a device. If a line is indented then it is a continuation of the previous line and the two combined represent the entire Device Marking for that device.

(6) Lead finish/Ball material - Orderable Devices may have multiple material finish options. Finish options are separated by a vertical ruled line. Lead finish/Ball material values may wrap to two lines if the finish value exceeds the maximum column width.

**Important Information and Disclaimer:**The information provided on this page represents TI's knowledge and belief as of the date that it is provided. TI bases its knowledge and belief on information provided by third parties, and makes no representation or warranty as to the accuracy of such information. Efforts are underway to better integrate information from third parties. TI has taken and continues to take reasonable steps to provide representative and accurate information but may not have conducted destructive testing or chemical analysis on incoming materials and chemicals. TI and TI suppliers consider certain information to be proprietary, and thus CAS numbers and other limited information may not be available for release.



In no event shall TI's liability arising out of such information exceed the total purchase price of the TI part(s) at issue in this document sold by TI to Customer on an annual basis.

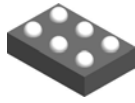
**OTHER QUALIFIED VERSIONS OF TPS61299 :**

- Automotive : [TPS61299-Q1](#)

NOTE: Qualified Version Definitions:

- Automotive - Q100 devices qualified for high-reliability automotive applications targeting zero defects

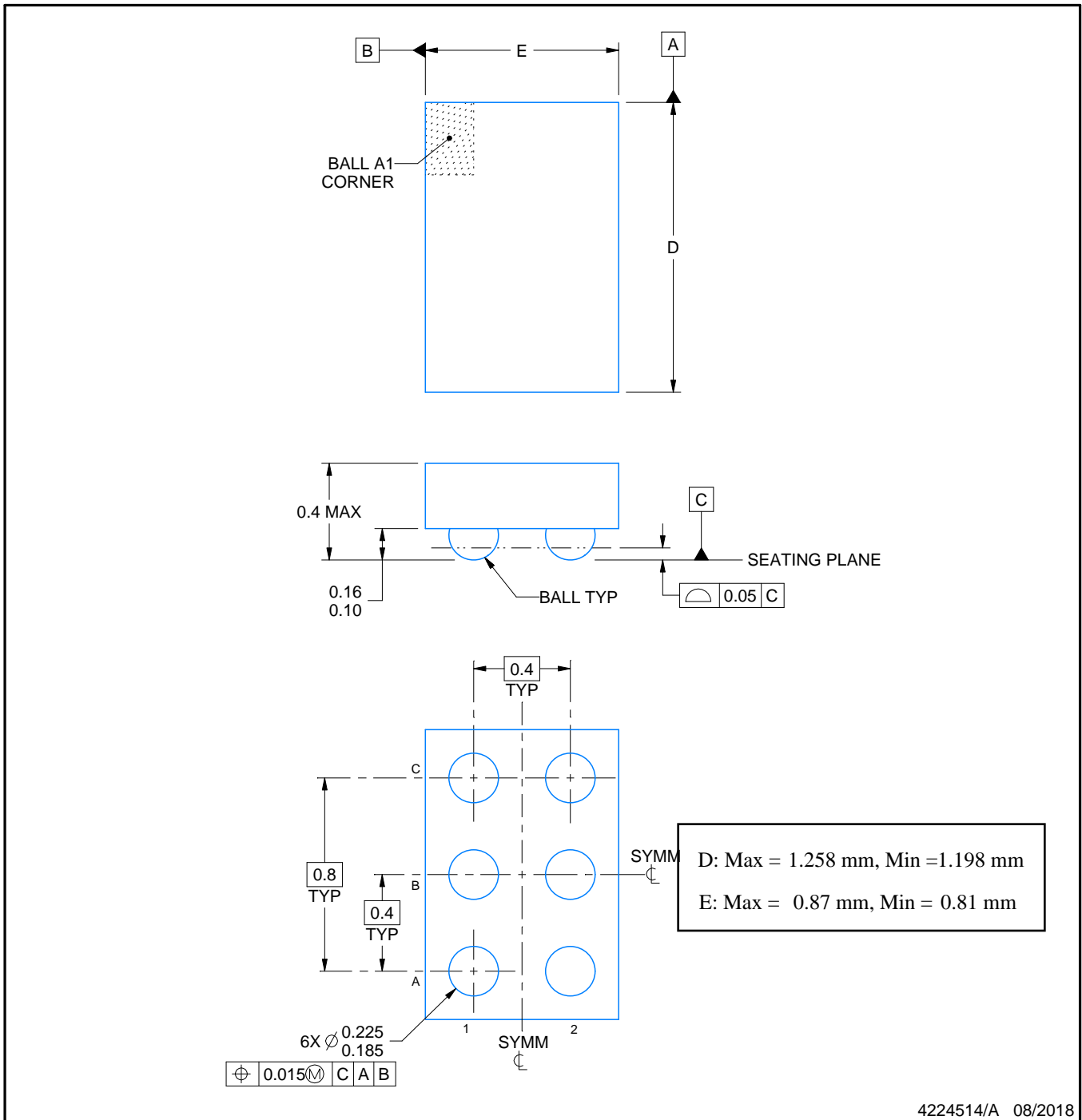
YBH0006



PACKAGE OUTLINE

DSBGA - 0.4 mm max height

DIE SIZE BALL GRID ARRAY



NOTES:

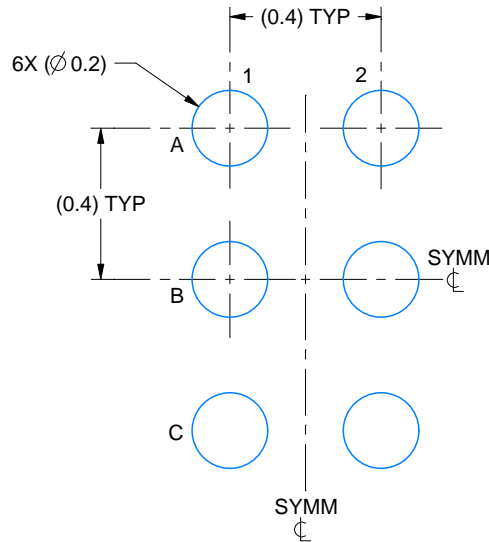
1. All linear dimensions are in millimeters. Any dimensions in parenthesis are for reference only. Dimensioning and tolerancing per ASME Y14.5M.
2. This drawing is subject to change without notice.

# EXAMPLE BOARD LAYOUT

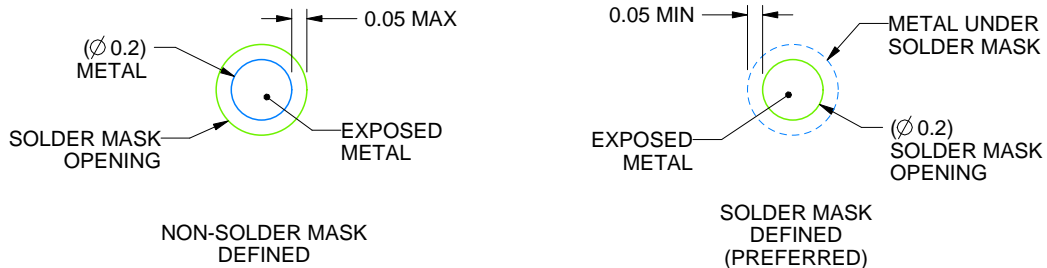
YBH0006

DSBGA - 0.4 mm max height

DIE SIZE BALL GRID ARRAY



LAND PATTERN EXAMPLE  
EXPOSED METAL SHOWN  
SCALE: 50X



SOLDER MASK DETAILS  
NOT TO SCALE

4224514/A 08/2018

NOTES: (continued)

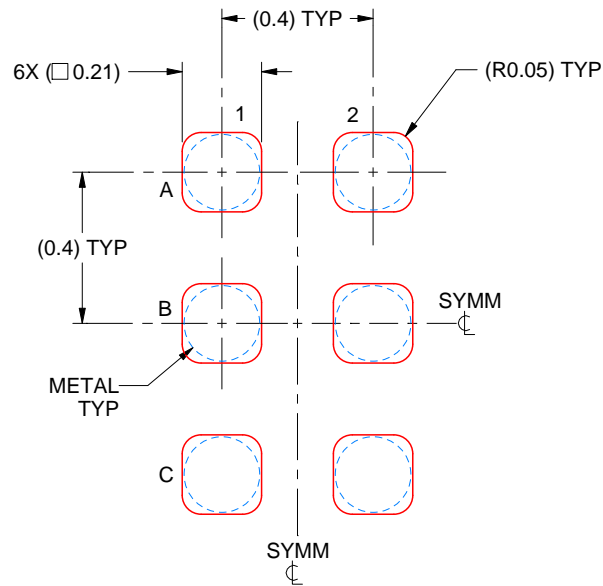
- Final dimensions may vary due to manufacturing tolerance considerations and also routing constraints. See Texas Instruments Literature No. SNVA009 ([www.ti.com/lit/snva009](http://www.ti.com/lit/snva009)).

# EXAMPLE STENCIL DESIGN

YBH0006

DSBGA - 0.4 mm max height

DIE SIZE BALL GRID ARRAY



SOLDER PASTE EXAMPLE  
BASED ON 0.075 mm THICK STENCIL  
SCALE: 50X

4224514/A 08/2018

NOTES: (continued)

4. Laser cutting apertures with trapezoidal walls and rounded corners may offer better paste release.

## IMPORTANT NOTICE AND DISCLAIMER

TI PROVIDES TECHNICAL AND RELIABILITY DATA (INCLUDING DATA SHEETS), DESIGN RESOURCES (INCLUDING REFERENCE DESIGNS), APPLICATION OR OTHER DESIGN ADVICE, WEB TOOLS, SAFETY INFORMATION, AND OTHER RESOURCES "AS IS" AND WITH ALL FAULTS, AND DISCLAIMS ALL WARRANTIES, EXPRESS AND IMPLIED, INCLUDING WITHOUT LIMITATION ANY IMPLIED WARRANTIES OF MERCHANTABILITY, FITNESS FOR A PARTICULAR PURPOSE OR NON-INFRINGEMENT OF THIRD PARTY INTELLECTUAL PROPERTY RIGHTS.

These resources are intended for skilled developers designing with TI products. You are solely responsible for (1) selecting the appropriate TI products for your application, (2) designing, validating and testing your application, and (3) ensuring your application meets applicable standards, and any other safety, security, regulatory or other requirements.

These resources are subject to change without notice. TI grants you permission to use these resources only for development of an application that uses the TI products described in the resource. Other reproduction and display of these resources is prohibited. No license is granted to any other TI intellectual property right or to any third party intellectual property right. TI disclaims responsibility for, and you will fully indemnify TI and its representatives against, any claims, damages, costs, losses, and liabilities arising out of your use of these resources.

TI's products are provided subject to [TI's Terms of Sale](#) or other applicable terms available either on [ti.com](https://www.ti.com) or provided in conjunction with such TI products. TI's provision of these resources does not expand or otherwise alter TI's applicable warranties or warranty disclaimers for TI products.

TI objects to and rejects any additional or different terms you may have proposed.

Mailing Address: Texas Instruments, Post Office Box 655303, Dallas, Texas 75265  
Copyright © 2024, Texas Instruments Incorporated