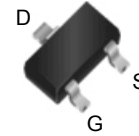

N-Channel 20V,1.2A, N-MOSFET

FEATURES

- TrenchFET® Power MOSFET: 1.8-V Rated
- Gate-Source ESD Protected
- High-Side Switching
- Low On-Resistance: 0.4Ω(max)
- Low Threshold: 0.7V (typ)
- Fast Switching Speed: 10 ns
- S- Prefix for Automotive and Other Applications Requiring

SOT-723

BENEFITS

- Ease in Driving Switches
- Low Offset (Error) Voltage
- Low-Voltage Operation
- High-Speed Circuits
- Low Battery Voltage Operation

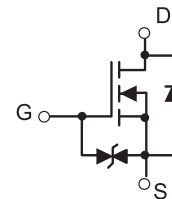

APPLICATIONS

- Drivers: Relays, Solenoids, Lamps, Hammers, Displays, Memories
- Battery Operated Systems
- Power Supply Converter Circuits
- Load/Power Switching Cell Phones, Pagers

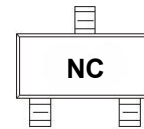

Part Number	Package	Quantity Per Reel	Reel Size
TNM01K20CX	SOT-723	3,000	7 Inch

ABSOLUTE MAXIMUM RATINGS (T _A = 25°C UNLESS OTHERWISE NOTED)					
Parameter	Symbol	5 secs	Steady State	Unit	
Drain-Source Voltage	V _{DS}	20		V	
Gate-Source Voltage	V _{GS}	± 12			
Continuous Drain Current (T _J = 150°C) ^b	I _D	T _A = 25°C	1200	900	mA
		T _A = 85°C	800	600	
Pulsed Drain Current ^a	I _{DM}	2500			
Continuous Source Current (diode conduction) ^b	I _S	275	250		
Maximum Power Dissipation ^b for SC-89	P _D	T _A = 25°C	275	250	mW
		T _A = 85°C	160	140	
Operating Junction and Storage Temperature Range	T _J , T _{stg}	-55 to 150		°C	

Notes

- d. Pulse width limited by maximum junction temperature.
e. Surface Mounted on FR4 Board.

● Electrical Characteristics (@TA=25°C unless otherwise noted)

Parameter	Symbol	Test Conditions	Min	Typ	Max	Unit
Drain-Source Breakdown Voltage	$V_{(BR)DSS}$	$V_{GS}=0V, I_D=250\mu A$	20	--	--	V
Zero Gate Voltage Drain Current	I_{DSS}	$V_{DS}=16V, V_{GS}=0V$	--	--	1	μA
Gate Threshold Voltage	$V_{GS(TH)}$	$V_{DS}=V_{GS}, I_{DS}=250\mu A$	0.5	--	1.0	V
Gate Leakage Current	I_{GSS}	$V_{GS}=\pm 12V, V_{DS}=0V$	--	--	± 10	μA
Drain-Source On-state Resistance	$R_{DS(on)}$	$V_{GS}=4.5V, I_D=0.5A$	--	250	400	m Ω
		$V_{GS}=2.5V, I_D=0.5A$	--	300	500	m Ω
		$V_{GS}=1.8V, I_D=0.35A$	--	400	650	m Ω
Total Gate Charge	Q_g	$V_{GS}=4.5V, V_{DS}=10V, I_D=1A$	--	2	--	nC
Gate- Source Charge	Q_{gs}		--	0.3	--	nC
Gate- Drain Charge	Q_{gd}		--	0.3	--	nC
Turn-on Delay Time	$t_{d(on)}$	$V_{GS}=4.5V, V_{DS}=10V, R_{GEN}=6\Omega, I_D=2A$	--	1.2	--	ns
Turn-on Rise Time	t_r		--	25	--	ns
Turn-off Delay Time	$t_{d(off)}$		--	14	--	ns
Turn-off Fall Time	t_f		--	15	--	ns
Input Capacitance	C_{iss}	$V_{GS}=0V, V_{DS}=10V, f=1MHz$	--	43	--	pF
Output Capacitance	C_{oss}		--	9	--	pF
Reverse Transfer Capacitance	C_{rss}		--	6	--	pF

● Reverse Diode Characteristics (@TA=25°C unless otherwise noted)

Parameter	Symbol	Test Conditions	Min	Typ	Max	Unit
Continuous Diode Forward Current	I_{SD}	$V_G=V_D=0V$, Force Current	--	--	3.5	A
Diode Forward Voltage	V_{SD}	$I_{SD}=0.5A, V_{GS}=0V$	--	--	1.3	V
Reverse Recovery Time	t_{rr}	$I_F = 1A$ $di/dt = 100 A/\mu s$	--	9	--	nS
Reverse Recovery Charge	Q_{rr}		--	1	--	nC

A: The value of $R_{\theta JA}$ is measured with the device mounted on 1in² FR-4 board with 2oz. Copper, in a still air environment with TA=25C. The value in any given application depends on the user's specific board design.

B: Repetitive rating, pulse width limited by junction temperature .

C: The current rating is based on the t<10s junction to ambient thermal resistance rating.

● TYPICAL ELECTRICAL AND THERMAL CHARACTERISTICS

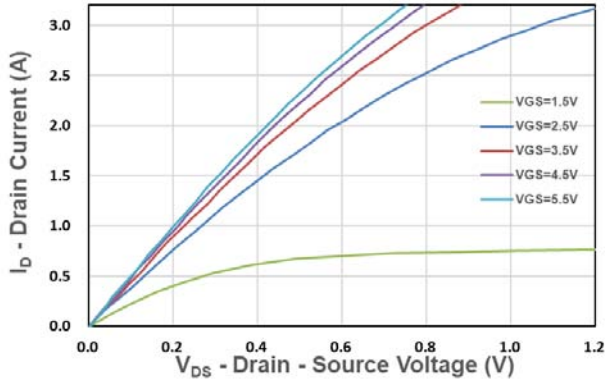

Figure 1. Output Characteristics

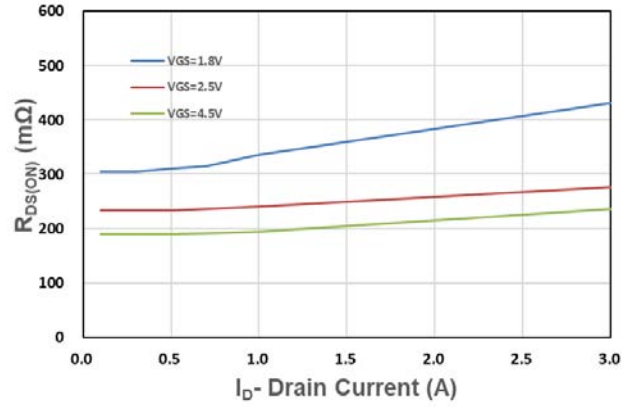

Figure 2. On-Resistance vs. I

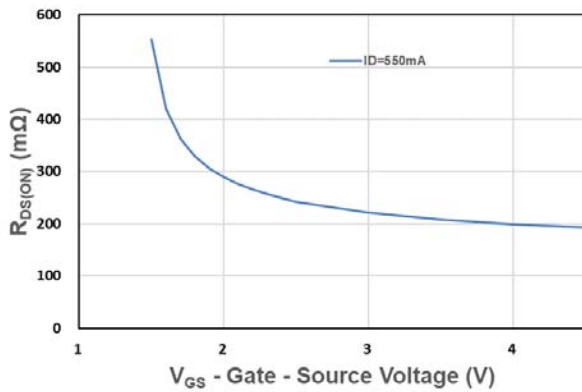

Figure 3. On-Resistance vs. VGS

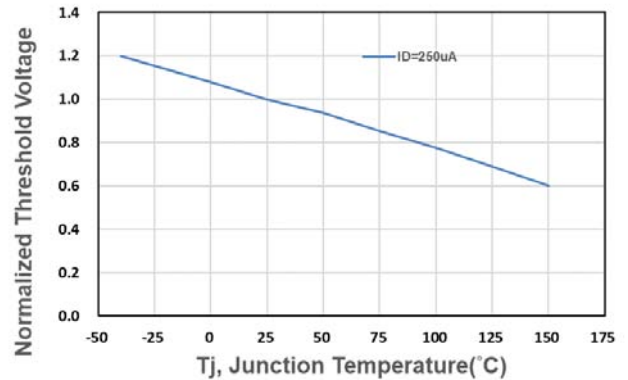

Figure 4. Gate Threshold Voltage

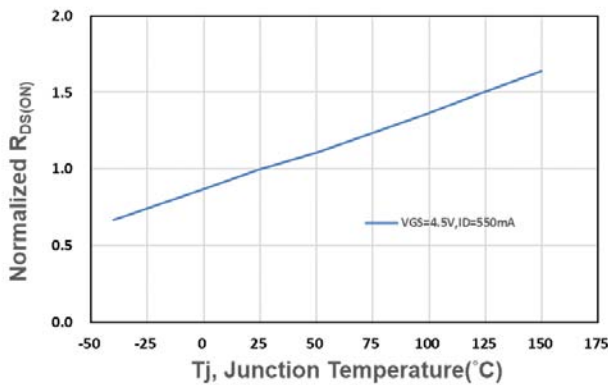

Figure 5. Drain-Source On Resistance

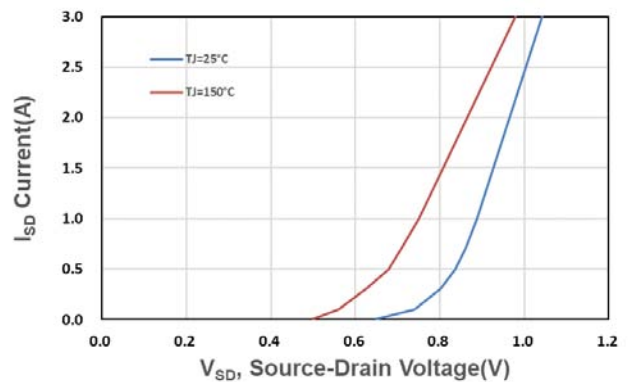

Figure 6. Source-Drain Diode Forward

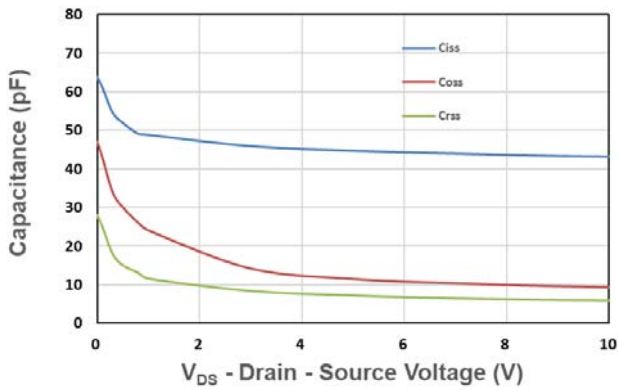

Figure 7. Capacitance

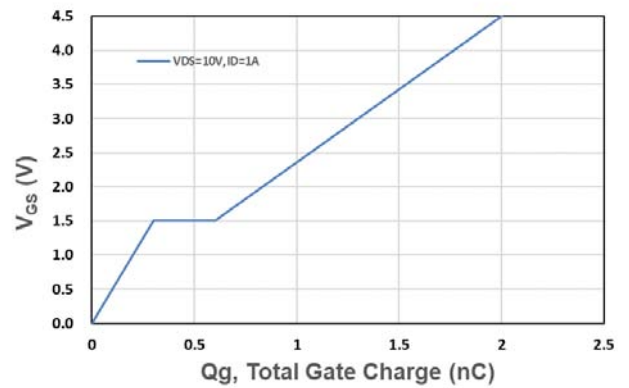

Figure 8. Gate Charge Characteristics

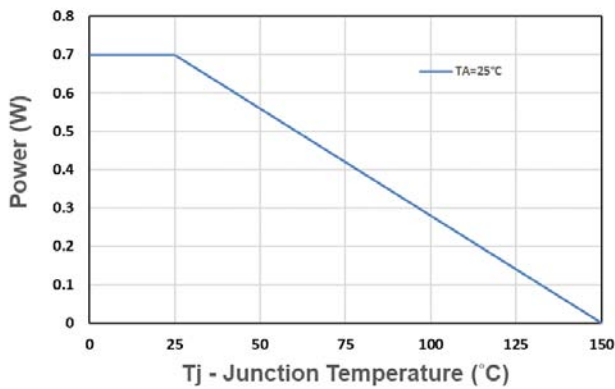

Figure 9. Power Dissipation

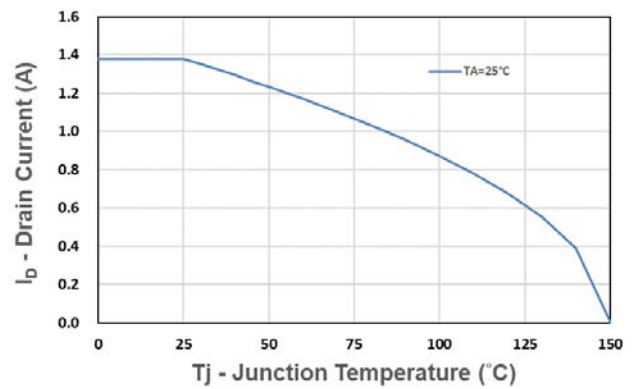

Figure 10. Drain Current

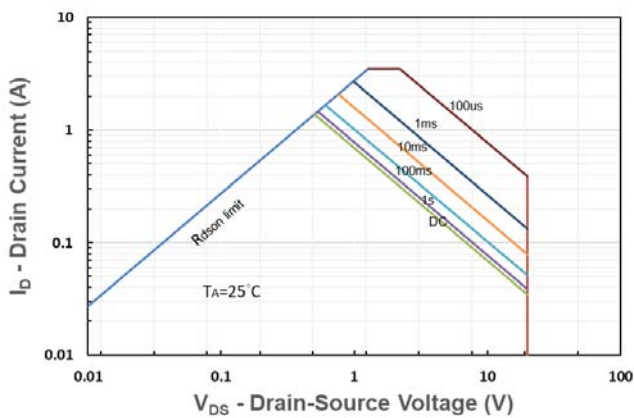

Figure 11. Safe Operating Area

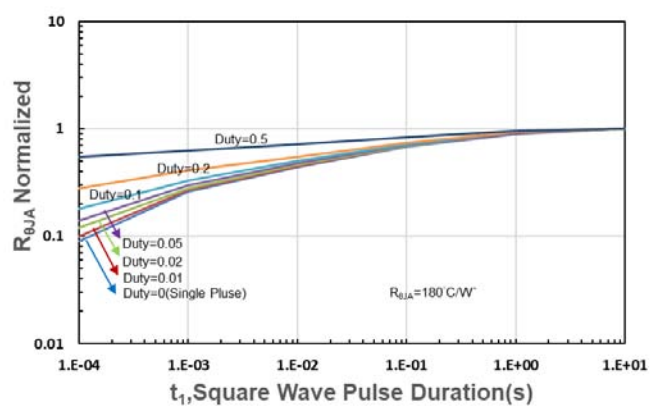
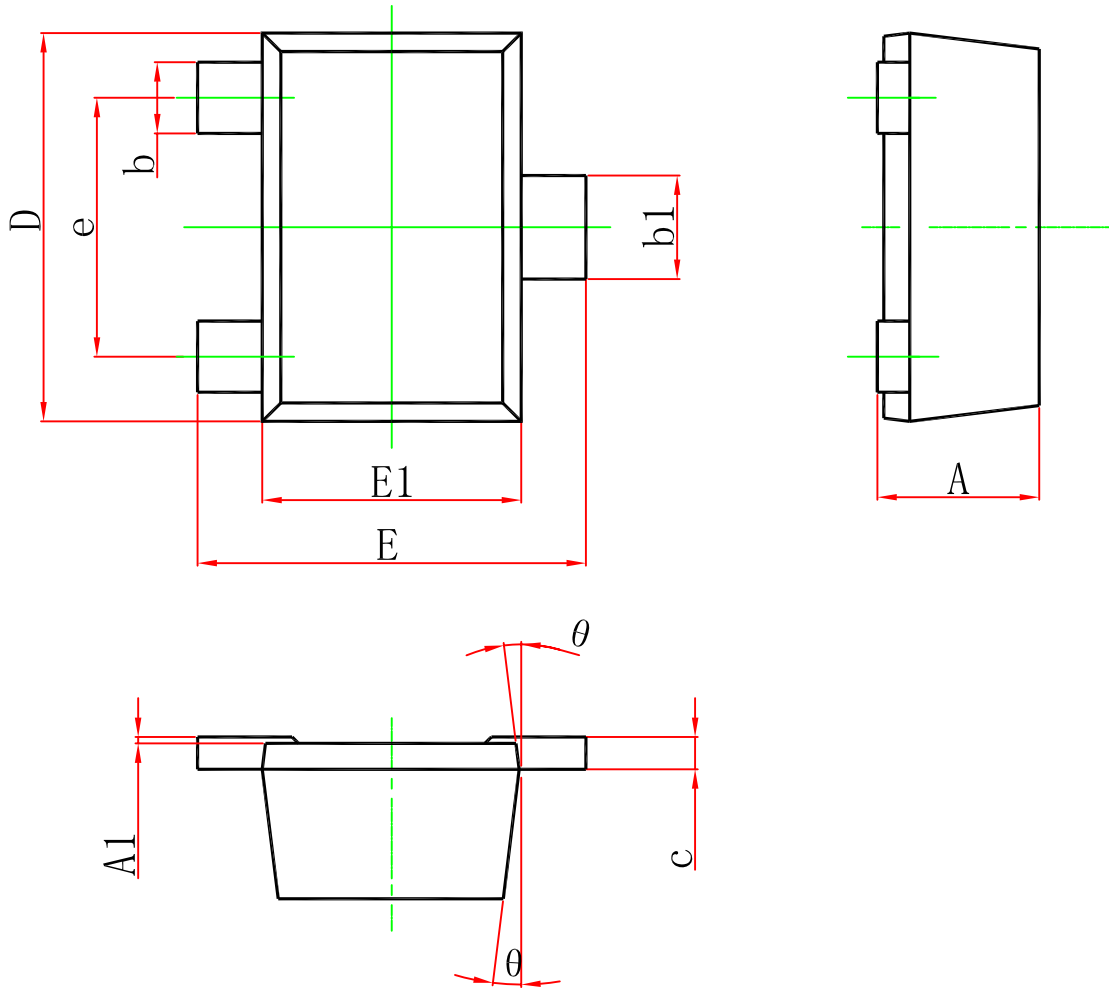
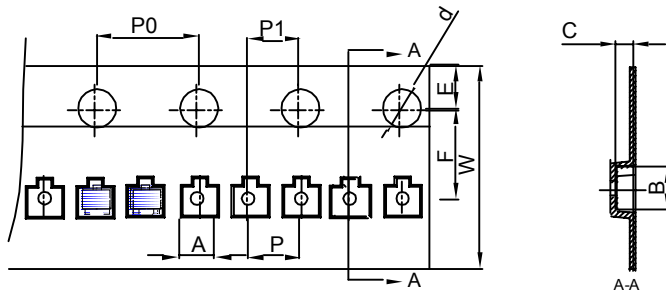

Figure 12. $R_{\theta JA}$ Transient Thermal Impedance

SOT-723 Package Information

Symbol	Dimensions In Millimeters		Dimensions In Inches	
	Min.	Max.	Min.	Max.
A	0.430	0.500	0.017	0.020
A1	0.000	0.050	0.000	0.002
b	0.170	0.270	0.007	0.011
b1	0.270	0.370	0.011	0.015
c	0.080	0.150	0.003	0.006
D	1.150	1.250	0.045	0.049
E	1.150	1.250	0.045	0.049
E1	0.750	0.850	0.030	0.033
e	0.800TYP.		0.031TYP.	
θ	7° REF.		7° REF.	

SOT-723 Tape and Reel
SOT-723 Embossed Carrier Tape

Dimensions are in millimeter											
Pkg type	A	B	C	d	E	F	P0	P	P1	W	
SOT-723	1.33	1.45	0.61	Ø1.50	1.75	3.50	4.00	2.00	2.00	8.00	

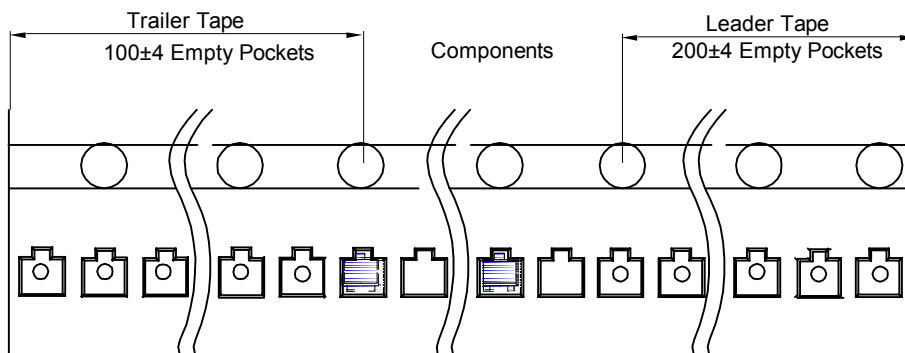
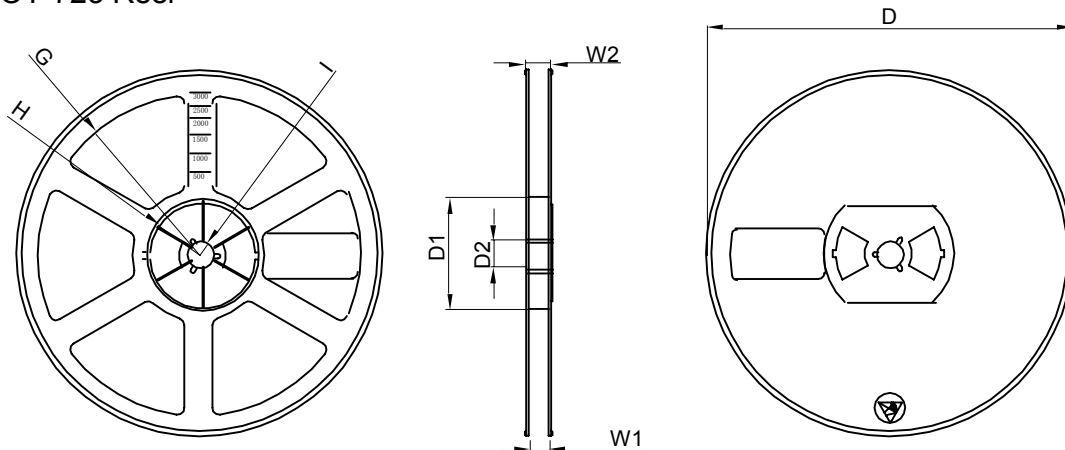
SOT-723 Tape Leader and Trailer

SOT-723 Reel

Dimensions are in millimeter								
Reel Option	D	D1	D2	G	H		W1	W2
7" Dia	Ø178.00	54.40	13.00	R78.00	R25.60	R6.50	9.50	12.30