

P-Channel 30-V (D-S) MOSFET

■ FEATURES

- Low $R_{DS(on)}$ Provides Higher Efficiency and Extends Battery Life
- Lower gate charge
- Fast Switch
- High performance trench technology
- Miniature SOT-23 Surface Mount Package Saves Board Space

■ Product Summary

MOSFET		
$V_{DS}(V)$	MAX($R_{DS(on)}(m\Omega)$)	$I_D (A)$
-30 V	50@ $V_{GS} = -10 V$	-4.2
	65@ $V_{GS} = -4.5 V$	-4.0
	96@ $V_{GS} = -2.5 V$	-1.0

■ Description

These miniature surface mount MOSFETs utilize High Cell Density process. Low $R_{DS(on)}$ assures minimal power loss and conserves energy, making this device ideal for use in power management circuitry. Typical applications are lower voltage application, power management in portable and battery-powered products such as computers, printers, and PCMCIA cards, cellular and cordless telephones.

■ SOT23

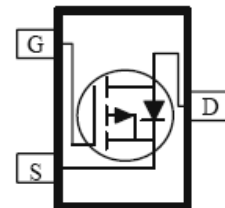
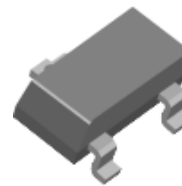

Maximum Ratings ($T_A = 25^\circ C$ UNLESS OTHERWISE NOTED)

Symbol	Parameter	Maximum	Unit
V_{DS}	Drain-Source Voltage	-30	V
V_{GS}	Gate-Source Voltage	± 12	
I_D	Continuous Drain Current ^a	$T_A=25^\circ C$	-4.2
		$T_A=70^\circ C$	-3.5
I_{DM}	Pulsed Drain Current ^b	-30	A
I_S	Continuous Source Current (Diode Conduction) ^a	-2.2	A
P_D	Power Dissipation ^a	1.38	W
	Liner Derating Factor		
T_J, T_{stg}	Operation Junction and Storage Temperature Range	-55 to 150	$^\circ C$

Thermal Resistance Ratings

Symbol	Parameter	Maximum	Unit
R_{THJA}	Maximum Junction-to-Ambient ^a	90	$^\circ C/W$

Notes:

- Surface Mounted on 1" x 1" FR4 Board.
- Pulse width limited by maximum junction temperature



Electrical Characteristics

SPECIFICATIONS (TA = 25°C UNLESS OTHERWISE NOTED)						
Parameter	Symbol	Test Condition	Limits			Unit
			Min	Typ	Max	
Switch Off Characteristics						
Drain-Source Breakdown Voltage	BV_{DSS}	$V_{GS}=0V, I_D=-250\mu A$	-30			V
Gate-Threshold Voltage	$V_{GS(th)}$	$V_{DS} = V_{GS}, I_D = 250\mu A$	-0.5		-1.2	V
Gate-Body Leakage	I_{GSS}	$V_{DS} = 0V, V_{GS} = \pm 12V$			± 100	nA
Zero Gate Voltage Drain Current	I_{DSS}	$V_{DS} = -24V, V_{GS} = 0V$ $T_J = 25^\circ C$			-1	uA
		$V_{DS} = -24V, V_{GS} = 0V,$ $T_J = 55^\circ C$			-5	
Drain-Source On-Resistance ^a	$R_{DS(on)}$	$V_{GS} = -10V, I_D = -4.2A$		43	50	mΩ
		$V_{GS} = -4.5V, I_D = -4.0A$		50	65	
		$V_{GS} = -2.5V, I_D = -1.0A$		70	96	
Forward Transconductance ^a	g_{fs}	$V_{DS} = -5V, I_D = -5A$		11		S
Diode Forward Voltage	V_{SD}	$I_S = -1.0A, V_{GS} = 0V$			-1.0	V
Reverse Recovery Time	T_{rr}	$I_S = -4A, V_{GS} = 0V,$ $di/dt = 100A/\mu S$		20.2		nS
Reverse Recovery Charge	Q_{rr}			11.2		nC
Dynamic ^b						
Total Gate Charge	Q_g	$V_{DS} = -15V, V_{GS} = -4.5V$ $I_D = -4A$		9.4	16	nC
Gate-Source Charge	Q_{gs}			2		
Gate-Drain Charge	Q_{gd}			3		
Turn-On Delay Time	$t_{d(on)}$	$V_{DS} = -15V, R_L = 3.6\Omega, R_G = 6\Omega,$ $V_{GS} = -10V$		6.3	13	ns
Turn-On Rise Time	t_r			3.2	8.4	
Turn-Off Delay Time	$t_{d(off)}$			38.2	48.5	
Turn-Off Fall Time	t_f			12	21.3	
Input Capacitance	C_{iss}	$V_{GS} = 0V, V_{DS} = -15V, f = 1.0MHz$		954	1104	pF
Output Capacitance	C_{oss}			115	187	
Reverse Transfer Capacitance	C_{rss}			77	97	
Gate Resistance	R_g	$f = 1.0MHz$		6		Ω

Notes:

- (a) Pulse test: pulse width $\leq 300\mu s$, duty cycle $\leq 2\%$
- (b) Guaranteed by design; not subject to production testing

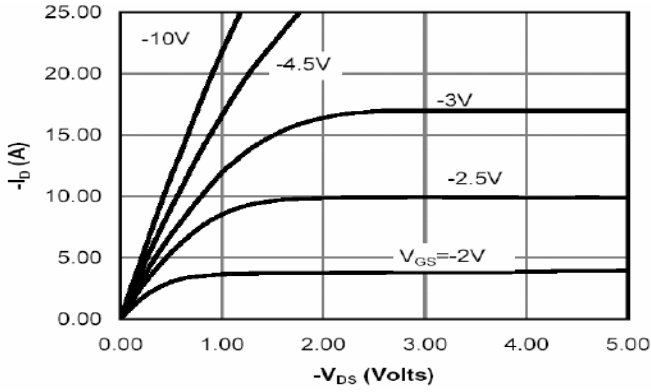
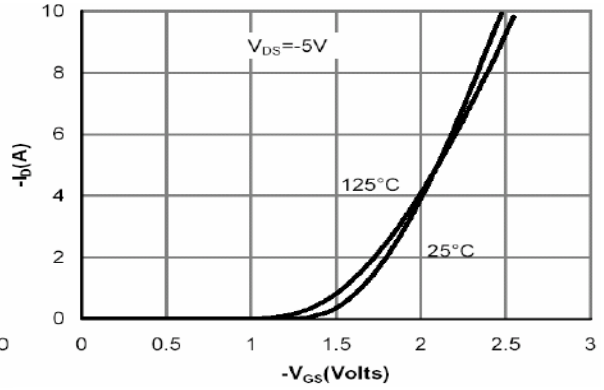
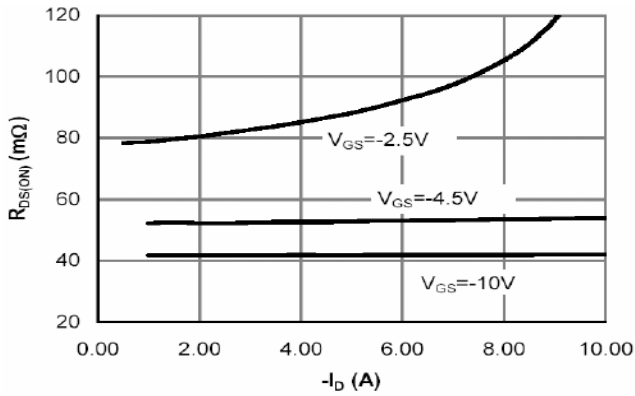
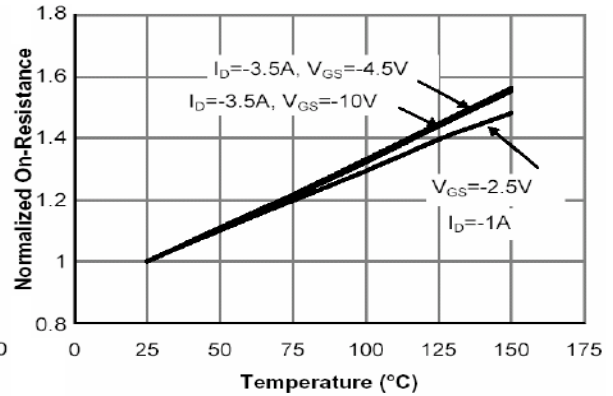
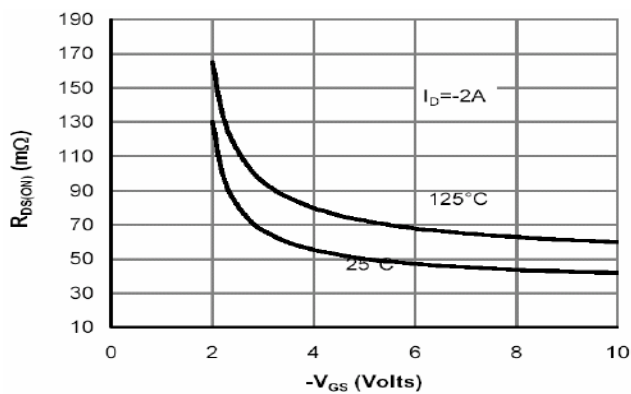
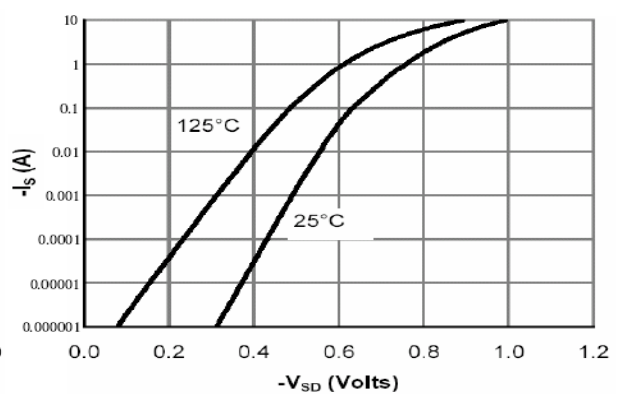
Typical Electrical Characteristics (P Channel)

Fig 1. Typical Output Characteristics

Fig 2. Transfer Characteristics

Fig 3. On-Resistance v.s. Drain Current and Gate Voltage

Fig 4. On-Resistance v.s. Junction Temperature

Fig 5. On-Resistance v.s. Gate-Source Voltage

Fig 6. Body Diode Characteristics



Typical Electrical Characteristics (P Channel)

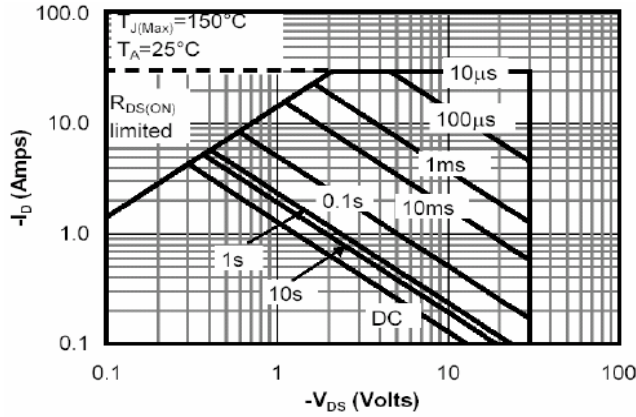

Fig 7. Maximum Safe Operating Area

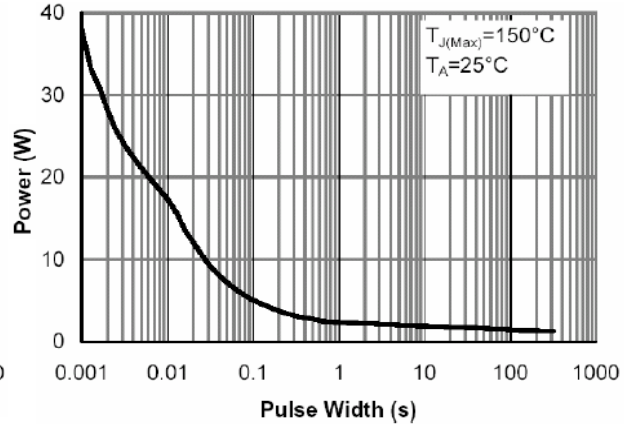

Fig 8. Single Pulse Power Rating Junction-to-Ambient

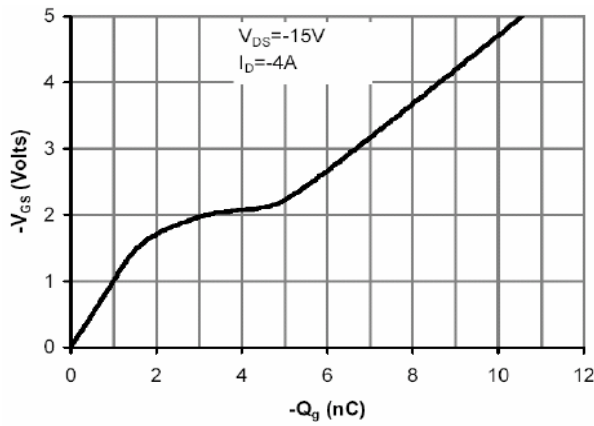

Fig 9. Gate Charge Characteristics

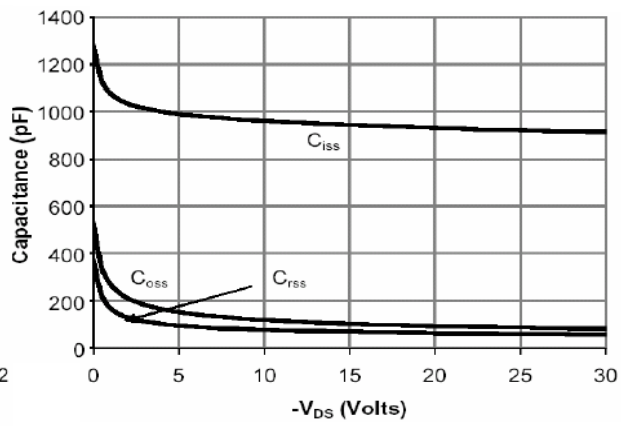

Fig 10. Typical Capacitance Characteristics

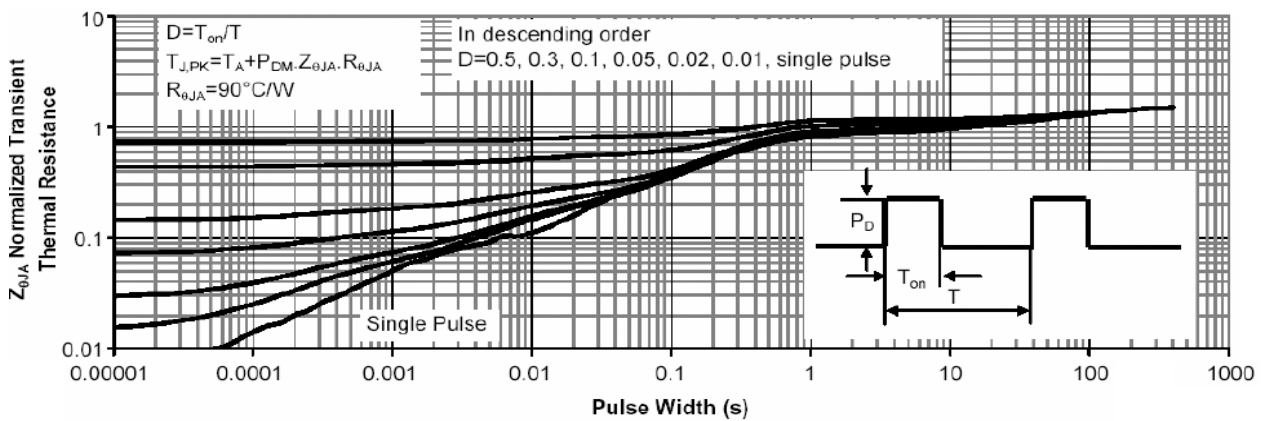
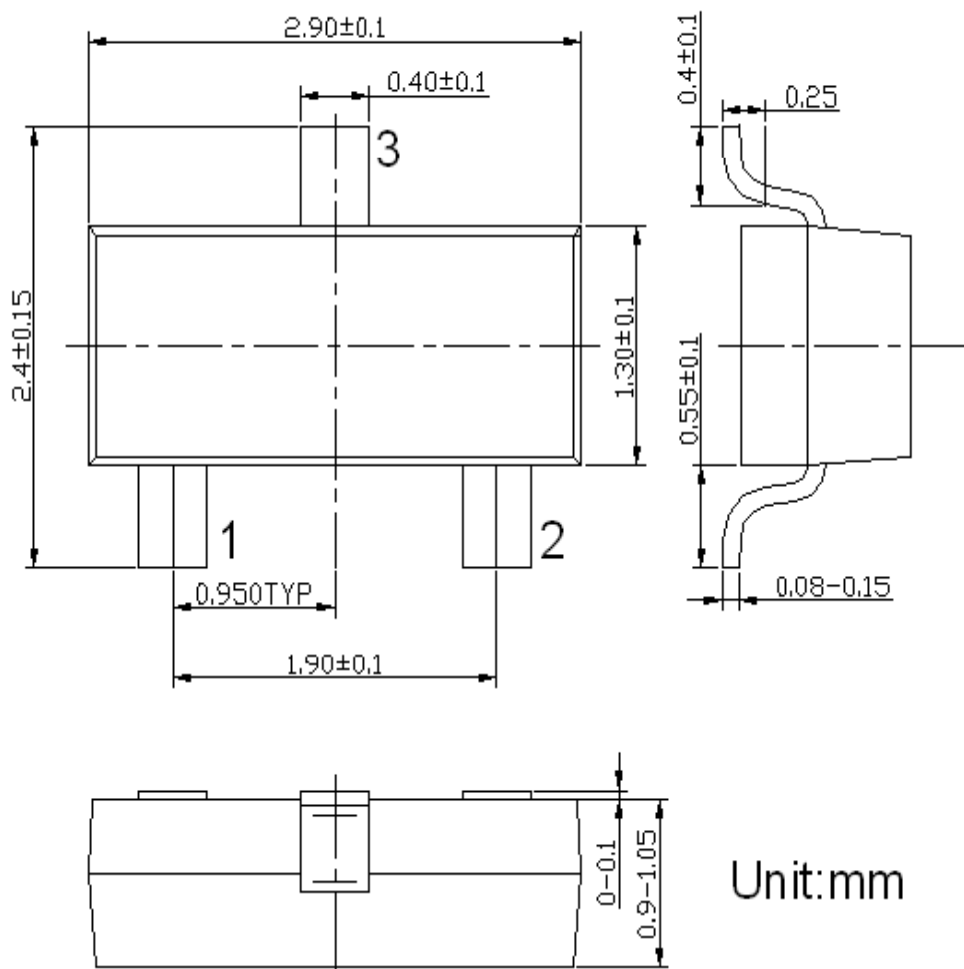

Fig 11. Normalized Maximum Transient Thermal Impedance

Ordering Information

Part number	Marking	package	Quantity per reel
JY3401AX	3401	SOT23	3000

Package Information
(SOT23)

Unit:mm

SOT23 Tape and reel

SOT23 Embossed Carrier Tape

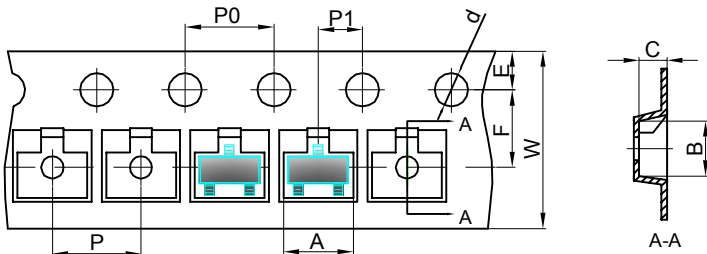

Dimensions are in millimeter										
Pkg type	A	B	C	d	E	F	P0	P	P1	W
SOT23	3.15	2.77	1.22	Ø1.50	1.75	3.50	4.00	4.00	2.00	8.00

SOT23 Tape Leader and Trailer

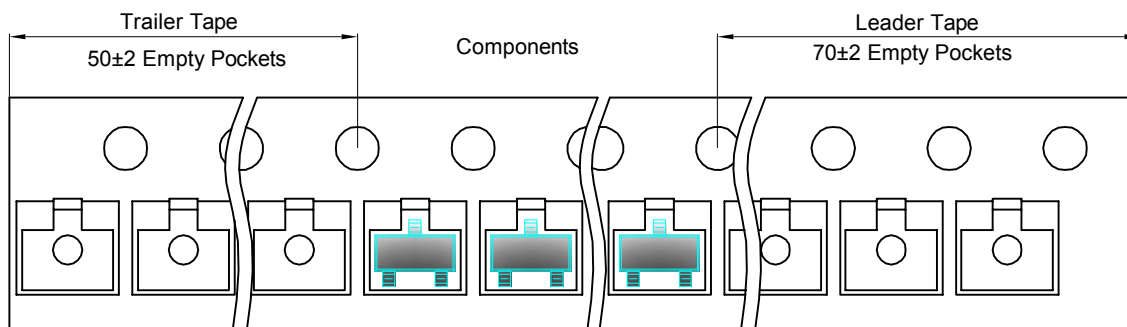

SOT23 Reel

3000 pcs

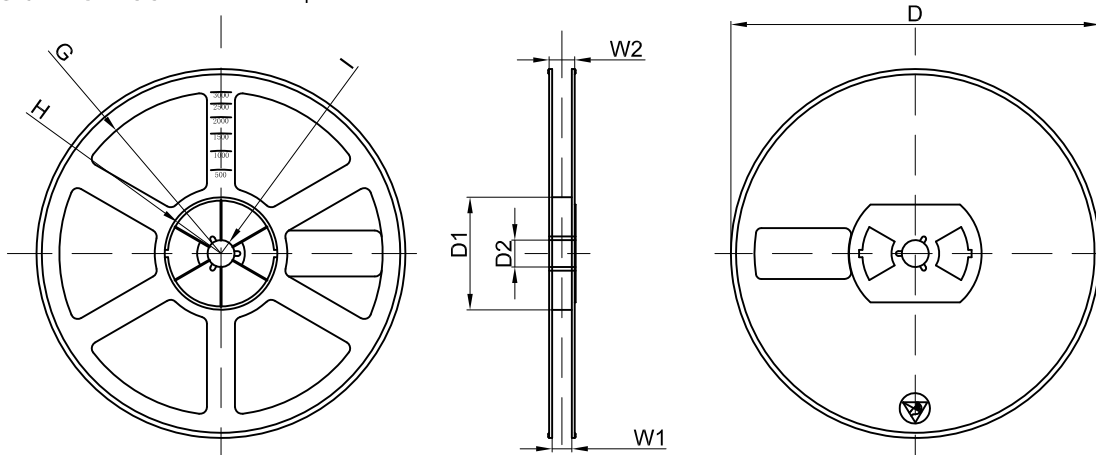

Dimensions are in millimeter								
Reel Option	D	D1	D2	G	H	I	W1	W2
7" Dia	Ø178.00	54.40	13.00	R78.00	R25.60	R6.50	9.50	12.30