

Features

- ❑ Transient protection for high-speed data lines
 - IEC 61000-4-2 (ESD) ±25kV (Air)
 - ±20kV (Contact)
 - IEC 61000-4-4 (EFT) 40A (5/50 ns)
 - Cable Discharge Event (CDE)
- ❑ Package optimized for high-speed lines
- ❑ Ultra-small package (1.0mm×0.6mm×0.55mm)
- ❑ Protects one data, control or power line
- ❑ Low capacitance: 0.30pF (Typical)
- ❑ Low leakage current: 10nA @ V_{RWM} (Typical)
- ❑ Low clamping voltage
- ❑ Each I/O pin can withstand over 1000 ESD strikes for ±8kV contact discharge
- ❑ ROHS compliant

Description

TT0541SBX is a low -capacitance Transient Voltage Suppressor (TVS) designed to provide electrostatic discharge (ESD) protection for high-speed data interfaces. With typical capacitance of 0.30pF only, TT0541SBX is designed to protect parasitic - sensitive systems against over-voltage and over-current transient events. It complies with IEC 61000-4-2 (ESD), Level 4 (±15kV air, ±8kV contact discharge), IEC 61000-4-4 (electrical fast transient - EFT) (40A, 5/50 ns), very fast charged device model (CDM) ESD and cable discharge event (CDE), etc.

TT0541SBX uses ultra-small uDFN-2L package. Each TT0541SBX device can protect one high-speed data line. It offers system designers flexibility to protect single data line where space is a premium concern. The combined features of low capacitance, ultra-small size and high ESD robustness make TT0541SBX ideal for high-speed data port and high-frequency line (e.g., USB 2.0 & antenna line) applications, such as cellular phones and HD visual devices.

Applications

- ❑ Serial ATA
- ❑ PCI Express
- ❑ Desktops, Servers and Notebooks
- ❑ Cellular Phones
- ❑ MDDI Ports
- ❑ USB2.0/3.0 Power and Data Line Protection
- ❑ Display Ports
- ❑ Digital Visual Interfaces (DVI)
- ❑ HDMI 1.4/2.0

Mechanical Characteristics

- ❑ DFN1006-2L Package
- ❑ Flammability Rating: UL 94V-0
- ❑ Marking: Part number
- ❑ Packaging: Tape and Reel

Circuit Diagram

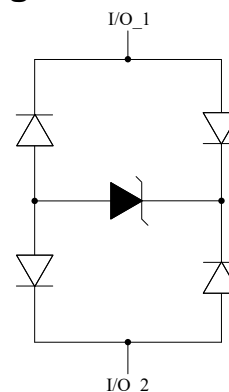

Pin Configuration

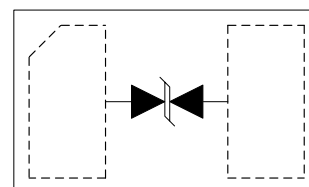

DFN1006-2L
(Top View)

Absolute Maximum Rating

Symbol	Parameter	Value	Units
I_{PP}	Peak Pulse Current($t_p=8/20\mu s$)	4.5	A
V_{ESD}	ESD per IEC 61000-4-2(Air) ESD per IEC 61000-4-2 (Contact)	± 25 ± 20	kV
T_{OPT}	Operating Temperature	-55/+125	$^{\circ}C$
T_{STG}	Storage Temperature	-55/+150	$^{\circ}C$

Electrical Characteristics (T = 25 $^{\circ}C$)

Symbol	Parameter
V_{RWM}	Nominal Reverse Working Voltage
I_R	Reverse Leakage Current @ V_{RWM}
V_{BR}	Reverse Breakdown Voltage @ I_T
I_T	Test Current for Reverse Breakdown
V_C	Clamping Voltage @ I_{PP}
I_{PP}	Peak Pulse Current
C_{ESD}	Parasitic Capacitance
V_R	Reverse Voltage
f	Small Signal Frequency

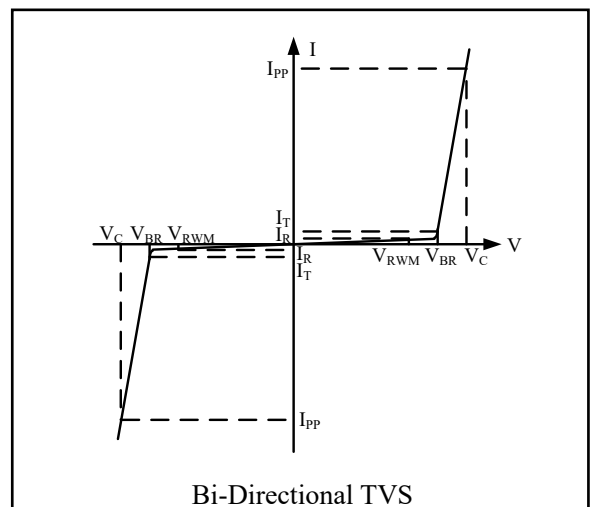

Symbol	Test Condition	Minimum	Typical	Maximum	Units
V_{RWM}				5.0	V
I_R	$V_{RWM} = 5V, T = 25^{\circ}C$ Between I/O and I/O		0.01	0.1	μA
V_{BR}	$I_T = 1mA$ Between I/O and I/O	7		9	V
V_C	$I_{PP} = 4.5A, t_p = 8/20\mu s$ Between I/O and I/O			15	V
C_{ESD}	$V_R = 0V, f = 1MHz$ Between I/O and I/O		0.3		pF

TLP Measurement of I/O to I/O

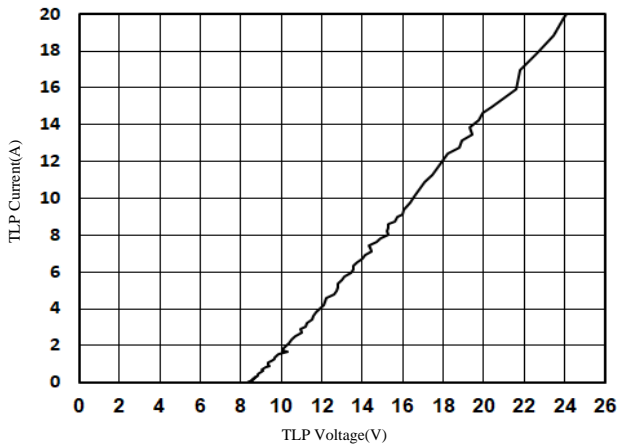

Insertion Loss S21 of I/O to I/O

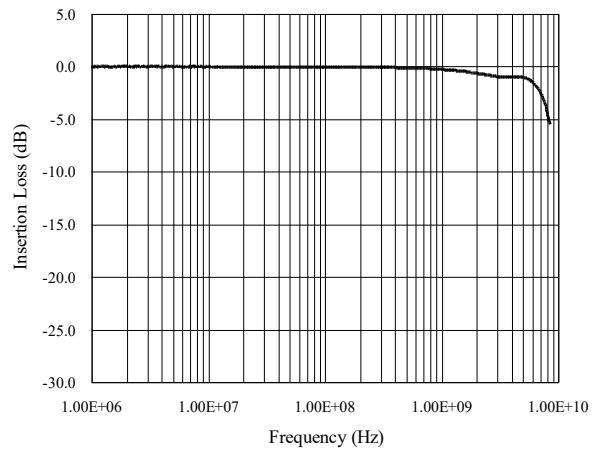

Capacitance vs. Voltage of I/O to I/O (f = 1MHz)

Capacitance vs. Reverse Voltage

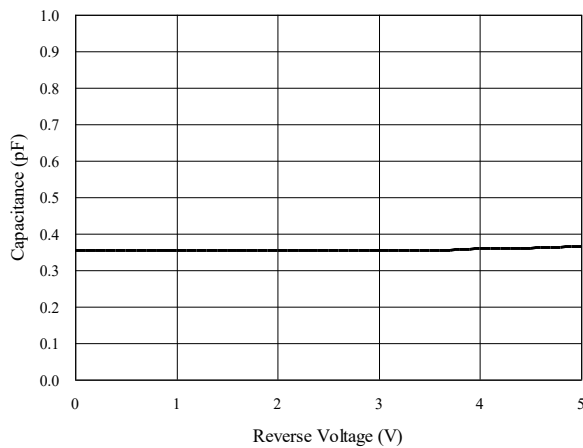

Normalized Capacitance vs. Reverse Voltage

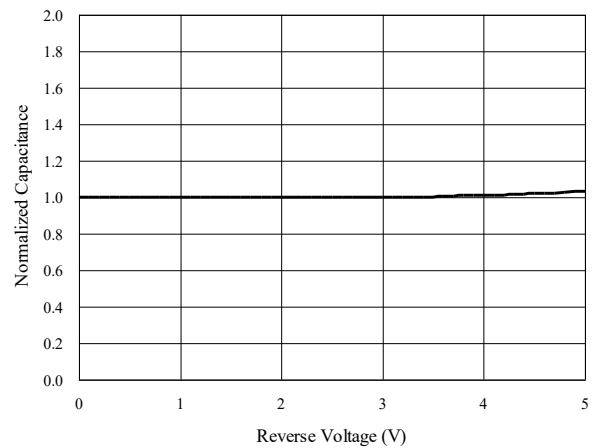

**ESD Clamping of I/O to I/O
(+8kV Contact per IEC 61000-4-2)**

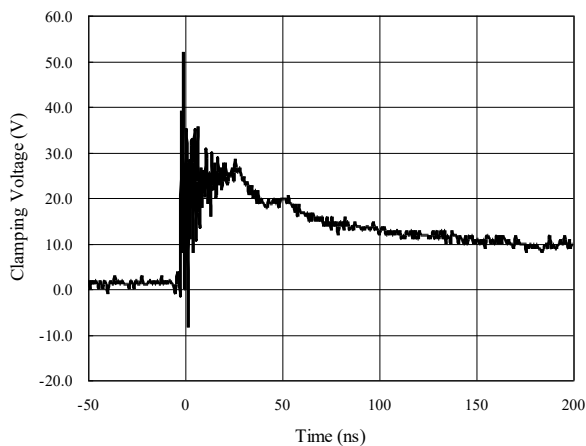

**ESD Clamping of I/O to I/O
(-8kV Contact per IEC 61000-4-2)**

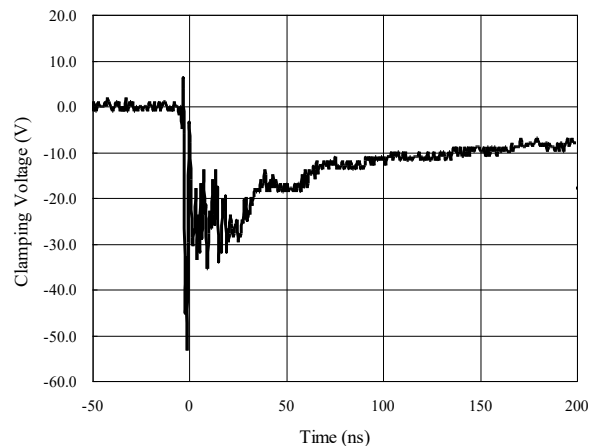

Package Outline

- DFN1006-2L Package
- MSL-1

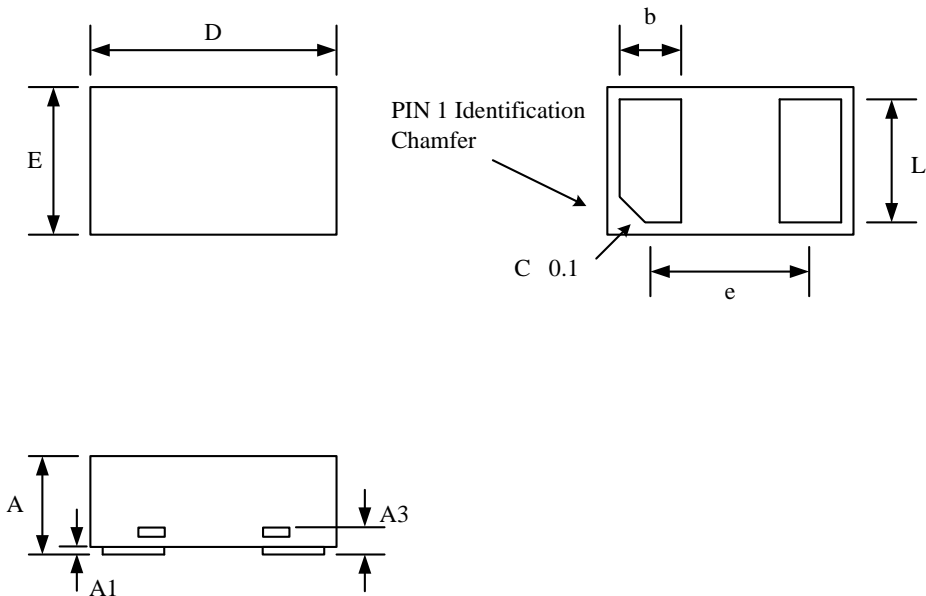

Package Dimensions (Controlling dimensions are in millimeters)

Symbol	Dimensions In Millimeters		Dimensions In Inches	
	Minimum	Maximum	Minimum	Maximum
A	0.400	0.550	0.016	0.022
A1	0.000	0.050	0.000	0.002
A3	0.125 REF		0.005 REF	
D	0.950	1.050	0.037	0.041
E	0.550	0.650	0.022	0.026
b	0.200	0.300	0.008	0.012
e	0.650 BSC		0.026 BSC	
L	0.450	0.550	0.018	0.022

Tape and Reel Specification

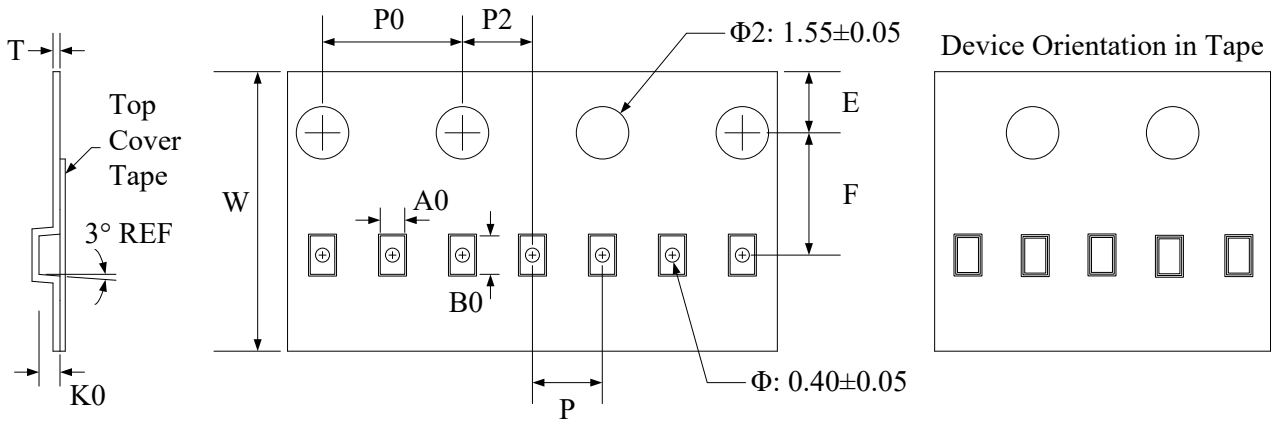

Symbol	W	A0	B0	K0	E	F	P	P0	P2	T
Dimensions (mm)	8.00±0.1	0.7±0.05	1.15±0.05	0.55±0.05	1.75±0.1	3.5±0.05	2.0±0.1	4.0±0.1	2.0±0.05	0.2±0.05

Marking Codes

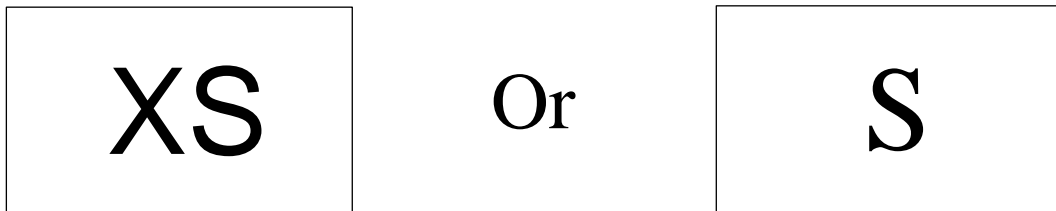

Note:

- (1) "S" is part number, fixed .
- (2) "X" is the internal code

Ordering Information

Part Number	Working Voltage	Quantity Per Reel	Reel Size
TT0541SBX	5V	10,000	7 Inch