

# C2M0045170P

Silicon Carbide Power MOSFET  
C2M™ MOSFET Technology  
N-Channel Enhancement Mode



TO-247-4L Plus



## Features

- 2<sup>nd</sup> generation SiC MOSFET technology
- Optimized package with separate driver source pin
- 8mm of creepage distance between drain and source
- High blocking voltage with low on-resistance
- High speed switching with low capacitances
- Resistant to latch-up
- Halogen free, RoHS compliant

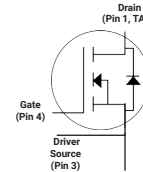

Package Types: TO-247-4L Plus  
PN's: C2M0045170P

WolfSpeed, Inc. is in the process of rebranding its products and related materials pursuant to the entity name change from Cree, Inc. to WolfSpeed, Inc. During this transition period, products received may be marked with either the Cree name and/or logo or the WolfSpeed name and/or logo.

## Applications

- Solar inverters
- Switch mode power supplies
- High voltage DC/DC converters
- Motor drive
- Pulsed power applications

## Benefits

- Reduce switching losses and minimize gate ringing
- Higher system efficiency
- Reduced cooling requirements
- Increased power density
- Increased system switching frequency

## Maximum Ratings ( $T_c = 25\text{ }^\circ\text{C}$ Unless Otherwise Specified)

Parameter	Symbol	Value	Unit	Test Conditions	Note
Drain - Source Voltage	$V_{DSmax}$	1700	V	$V_{GS} = 0\text{ V}, I_D = 100\text{ }\mu\text{A}$	
Gate - Source Voltage	$V_{GSmax}$	-10/+25		Absolute Maximum Values, AC ( $f > 1\text{ Hz}$ )	Note: 1
Gate - Source Voltage	$V_{GSop}$	-5/+20		Recommended Operational Values	Note: 2
Continuous Drain Current	$I_D$	75	A	$V_{GS} = 20\text{ V}, T_c = 25\text{ }^\circ\text{C}$	Fig. 19
		48		$V_{GS} = 20\text{ V}, T_c = 100\text{ }^\circ\text{C}$	
Pulsed Drain Current	$I_{D(pulse)}$	160		Pulse Width $t_p$ Limited by $T_{jmax}$	Fig. 22
Power Dissipation	$P_D$	338	W	$T_c = 25\text{ }^\circ\text{C}, T_J = 150\text{ }^\circ\text{C}$	Fig. 20
Operating Junction and Storage Temperature	$T_J, T_{stg}$	-40 to +150	$^\circ\text{C}$		
Solder Temperature	$T_L$	260	$^\circ\text{C}$	According to JEDEC J-STD-020	

Note (1): When using MOSFET body diode  $V_{GSmax} = -5\text{ V}/+25\text{ V}$ .

Note (2): MOSFET can also safely operate at  $0/+20\text{ V}$ .

**Electrical Characteristics** ( $T_C = 25\text{ }^\circ\text{C}$  Unless Otherwise Specified)

Parameter	Symbol	Min.	Typ.	Max.	Unit	Test Conditions	Note
Drain-Source Breakdown Voltage	$V_{(BR)DSS}$	1700				$V_{GS} = 0\text{ V}, I_D = 100\text{ }\mu\text{A}$	
Gate Threshold Voltage	$V_{GS(th)}$	2.0	3.0	4	V	$V_{DS} = V_{GS}, I_D = 18\text{ mA}$	Fig. 11
			2.5			$V_{DS} = V_{GS}, I_D = 18\text{ mA}, T_J = 150\text{ }^\circ\text{C}$	
Zero Gate Voltage Drain Current	$I_{DSS}$		2	100	$\mu\text{A}$	$V_{DS} = 1700\text{ V}, V_{GS} = 0\text{ V}$	
Gate-Source Leakage Current	$I_{GSS}$			600	nA	$V_{GS} = 20\text{ V}, V_{DS} = 0\text{ V}$	
Drain-Source On-State Resistance	$R_{DS(on)}$		40	70	m $\Omega$	$V_{GS} = 20\text{ V}, I_D = 50\text{ A}$	Fig. 4,5,6
			80			$V_{GS} = 20\text{ V}, I_D = 50\text{ A}, T_J = 150\text{ }^\circ\text{C}$	
Transconductance	$g_{fs}$		24.7		S	$V_{DS} = 20\text{ V}, I_{DS} = 50\text{ A}$	Fig. 7
			23.4			$V_{DS} = 20\text{ V}, I_{DS} = 50\text{ A}, T_J = 150\text{ }^\circ\text{C}$	
Input Capacitance	$C_{iss}$		3455		pF	$V_{GS} = 0\text{ V}$ $V_{DS} = 1200\text{ V}$ $f = 1\text{ MHz}$ $V_{AC} = 25\text{ mV}$	Fig. 17,18
Output Capacitance	$C_{oss}$		171				
Reverse Transfer Capacitance	$C_{riss}$		6.7				
$C_{oss}$ Stored Energy	$E_{oss}$		139		$\mu\text{J}$		Fig. 16
Effective Output Capacitance (Energy Related)	$C_{o(er)}$		188		pF	$V_{GS} = 0\text{ V}, V_{DS} = 0 \dots 1200\text{ V}$	Note: 3
Effective Output Capacitance (Time Related)	$C_{o(tr)}$		255		pF		
Turn-On Switching Energy (SiC Diode FWD)	$E_{ON}$		0.52		mJ	$V_{DS} = 1200\text{ V}, V_{GS} = -5/20\text{ V},$ $I_D = 50\text{ A}, R_{G(ext)} = 2.5\text{ }\Omega, L = 99\text{ }\mu\text{H},$ $T_J = 150\text{ }^\circ\text{C},$ Using SiC Diode as FWD	Fig. 26, 29b Note 2
Turn Off Switching Energy (SiC Diode FWD)	$E_{OFF}$		0.43				
Turn-On Switching Energy (Body Diode FWD)	$E_{ON}$		2.0		mJ	$V_{DS} = 1200\text{ V}, V_{GS} = -5/20\text{ V},$ $I_D = 50\text{ A}, R_{G(ext)} = 2.5\text{ }\Omega, L = 99\text{ }\mu\text{H},$ $T_J = 150\text{ }^\circ\text{C},$ Using MOSFET as FWD	Fig. 26, 29a Note 2
Turn Off Switching Energy (Body Diode FWD)	$E_{OFF}$		0.31				
Turn-On Delay Time	$t_{d(on)}$		15		ns	$V_{DD} = 1200\text{ V}, V_{GS} = -5/20\text{ V}$ $I_D = 50\text{ A},$ $R_{G(ext)} = 2.5\text{ }\Omega,$ Timing Relative to $V_{DS}$ Inductive Load	Fig. 27, 29 Note 2
Rise Time	$t_r$		18				
Turn-Off Delay Time	$t_{d(off)}$		34				
Fall Time	$t_f$		12				
Internal Gate Resistance	$R_{G(int)}$		1.3		$\Omega$	$f = 1\text{ MHz}, V_{AC} = 25\text{ mV}$	
Gate to Source Charge	$Q_{gs}$		46		nC	$V_{DS} = 1200\text{ V}, V_{GS} = -5/20\text{ V}$ $I_D = 50\text{ A}$ Per IEC60747-8-4 pg 21	Fig. 12
Gate to Drain Charge	$Q_{gd}$		71				
Total Gate Charge	$Q_g$		204				

Note (3):  $C_{o(er)}$ , a lumped capacitance that gives same stored energy as  $C_{oss}$  while  $V_{DS}$  is rising from 0 to 1200 V.

$C_{o(tr)}$ , a lumped capacitance that gives same charging time as  $C_{oss}$  while  $V_{DS}$  is rising from 0 to 1200 V.



## Reverse Diode Characteristics

Parameter	Symbol	Typ.	Max.	Unit	Test Conditions	Note
Diode Forward Voltage	$V_{SD}$	3.8		V	$V_{GS} = -5\text{ V}, I_{SD} = 25\text{ A}$	Fig. 8, 9, 10 Note 1
		3.4			$V_{GS} = -5\text{ V}, I_{SD} = 25\text{ A}, T_J = 150\text{ }^\circ\text{C}$	
Continuous Diode Forward Current	$I_S$		76	A	$V_{GS} = -5\text{ V}, T_C = 25\text{ }^\circ\text{C}$	Note 1
Diode Pulse Current	$I_{S, pulse}$		160		$V_{GS} = -5\text{ V}, \text{Pulse Width } t_p \text{ Limited by } T_{Jmax}$	Note 1
Reverse Recovery Time	$t_{rr}$	44		ns	$V_{GS} = -5\text{ V}, I_{SD} = 50\text{ A}, V_R = 1200\text{ V}$ $dif/dt = 4030\text{ A}/\mu\text{s}, T_J = 150\text{ }^\circ\text{C}$	
Reverse Recovery Charge	$Q_{rr}$	1.9		nC		
Peak Reverse Recovery Current	$I_{rrm}$	64		A		
Reverse Recovery Time	$t_{rr}$	25		ns	$V_{GS} = -5\text{ V}, I_{SD} = 50\text{ A}, V_R = 1200\text{ V}$ $dif/dt = 13450\text{ A}/\mu\text{s}, T_J = 150\text{ }^\circ\text{C}$	
Reverse Recovery Charge	$Q_{rr}$	2.4		nC		
Peak Reverse Recovery Current	$I_{rrm}$	166		A		

## Thermal Characteristics

Parameter	Symbol	Typ.	Max	Unit	Test Conditions	Note
Thermal Resistance from Junction to Case	$R_{\theta JC}$	0.22	0.37	$^\circ\text{C}/\text{W}$		Fig. 21
Thermal Resistance from Junction to Ambient	$R_{\theta JA}$		40			



Typical Performance

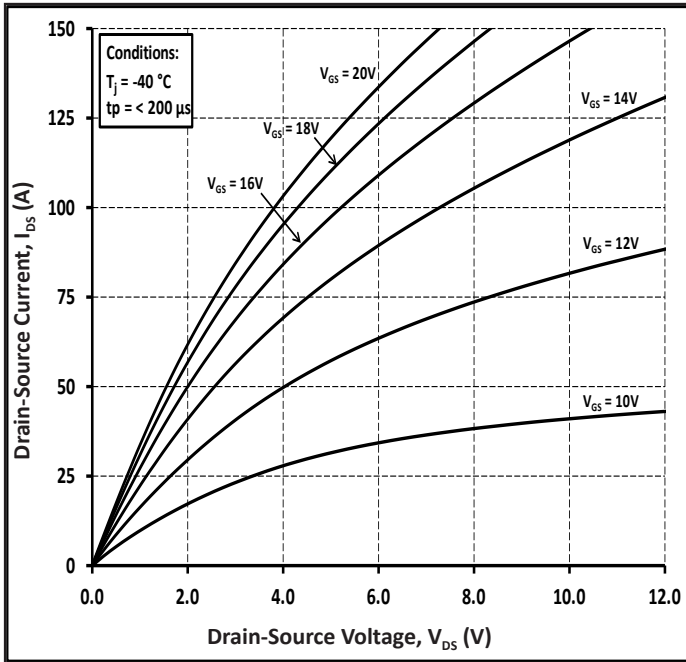

Figure 1. Output Characteristics  $T_j = -40\text{ }^\circ\text{C}$

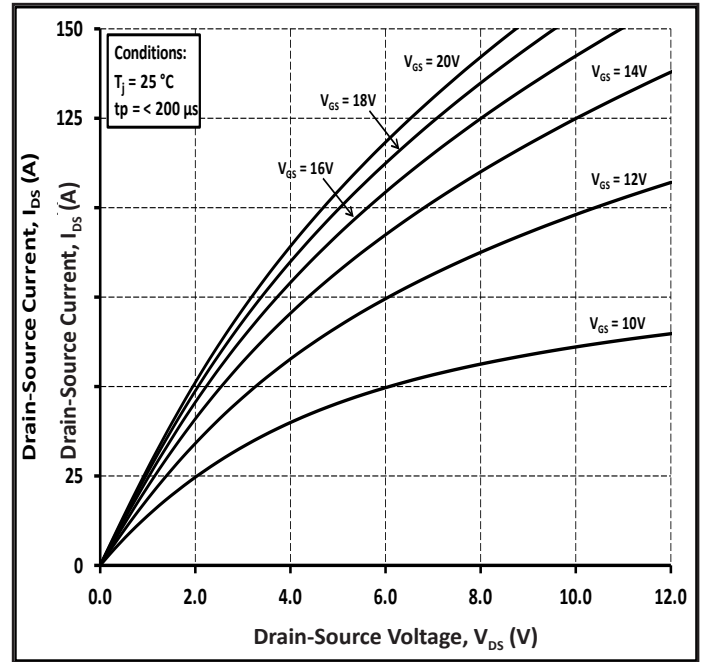

Figure 2. Output Characteristics  $T_j = 25\text{ }^\circ\text{C}$

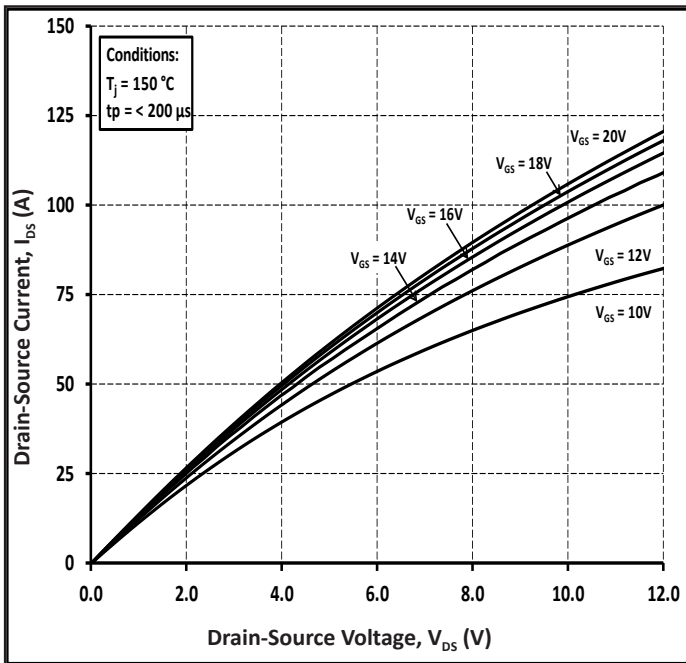

Figure 3. Output Characteristics  $T_j = 150\text{ }^\circ\text{C}$

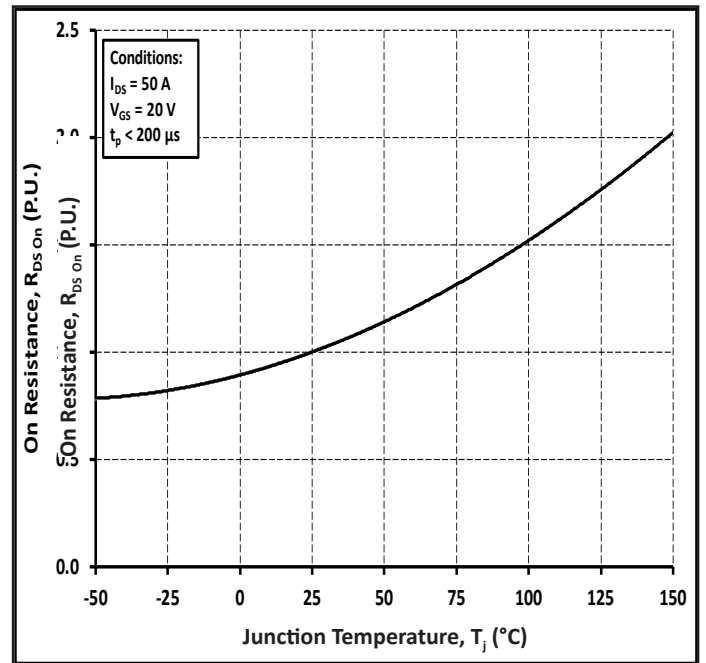

Figure 4. Normalized On-Resistance vs Temperature



Typical Performance

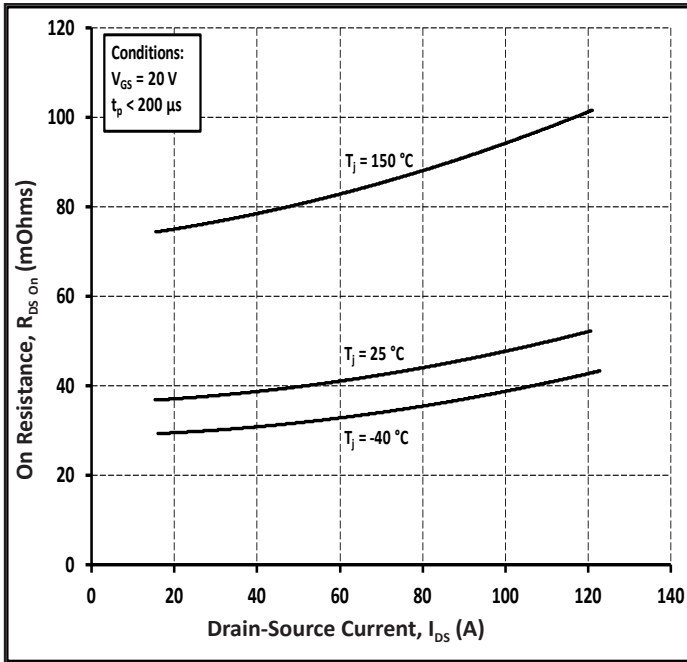

Figure 5. On-Resistance vs Drain Current for Various Temperatures

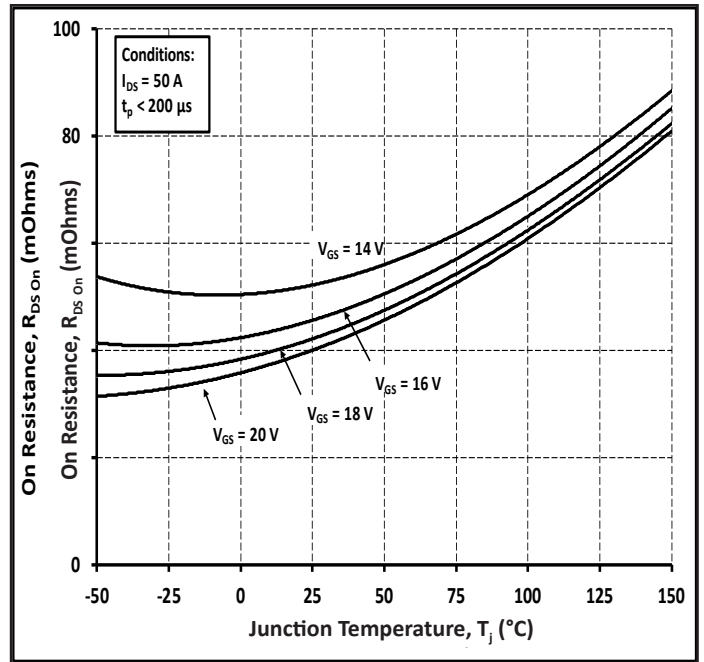

Figure 6. On-Resistance vs Temperature for Various Gate Voltage

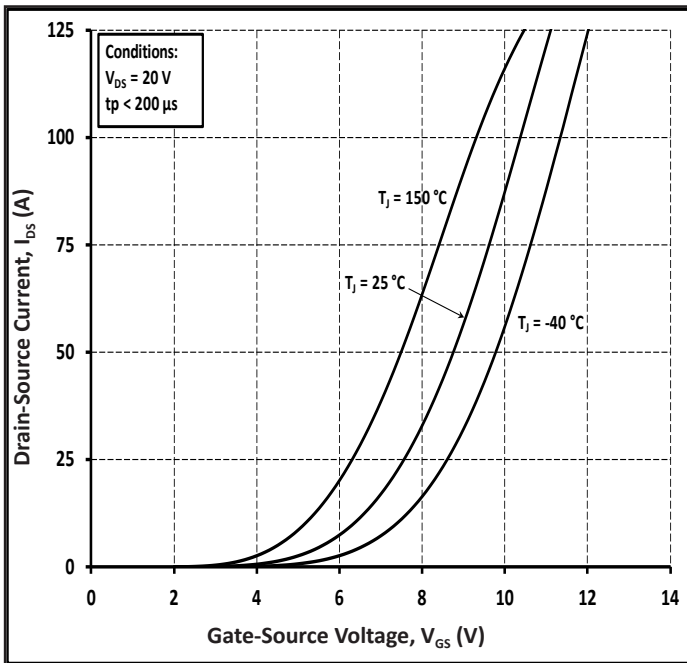

Figure 7. Transfer Characteristic for Various Junction Temperatures

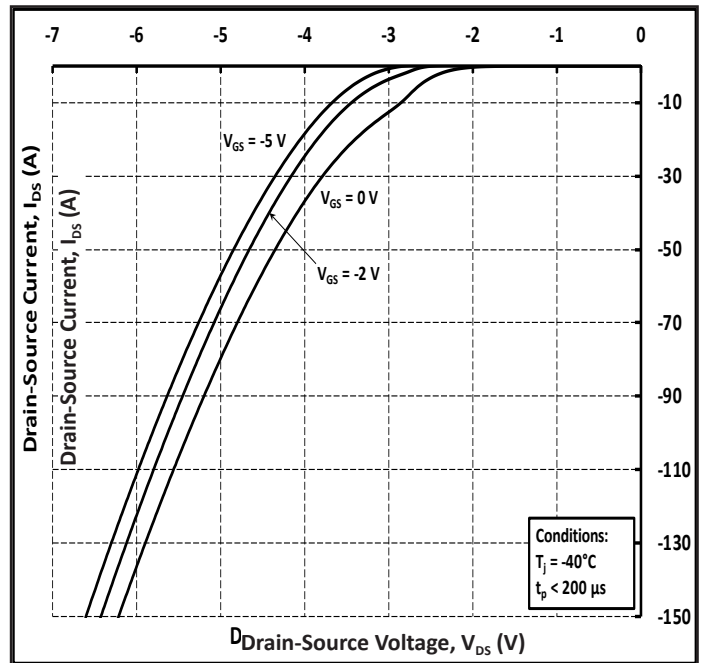

Figure 8. Body Diode Characteristic at -40 °C



Typical Performance

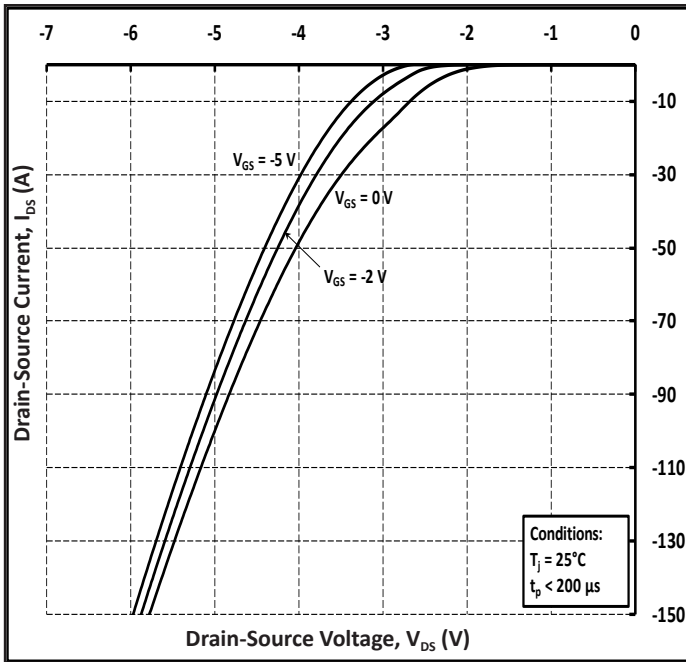

Figure 9. Body Diode Characteristic at 25 °C

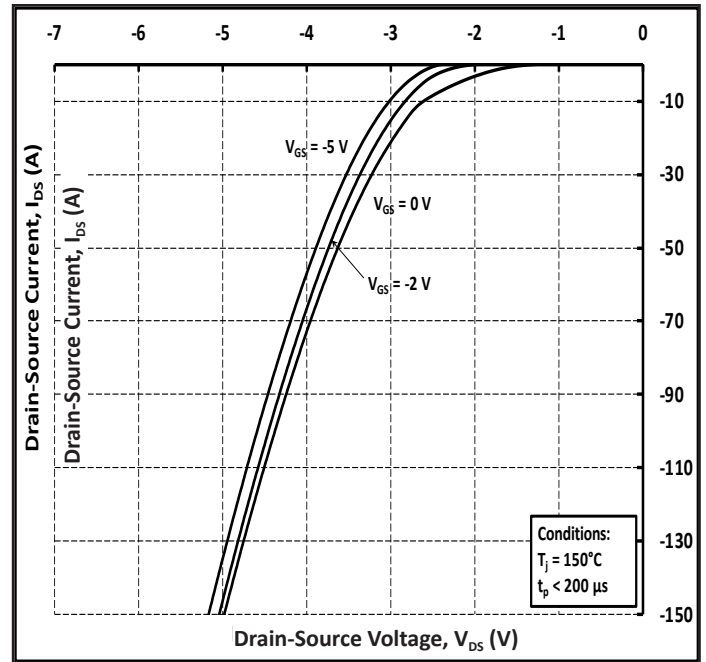

Figure 10. Body Diode Characteristic at 150 °C

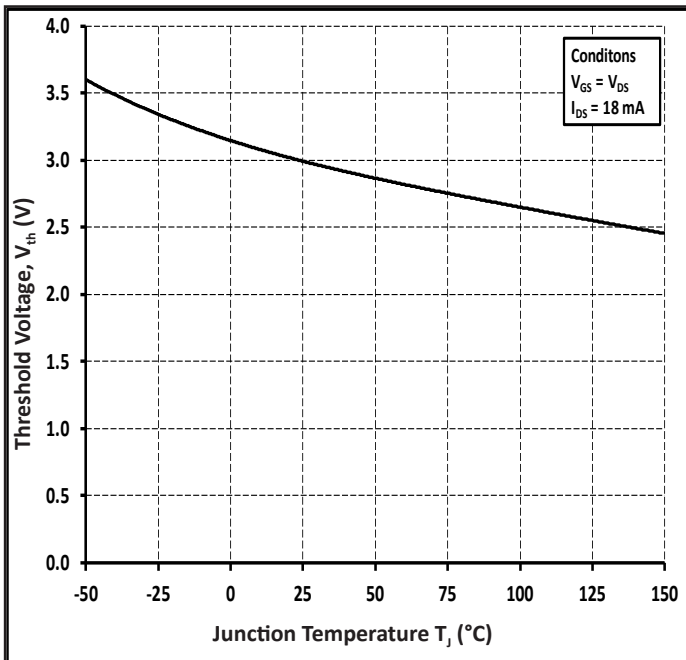

Figure 11. Threshold Voltage vs Temperature

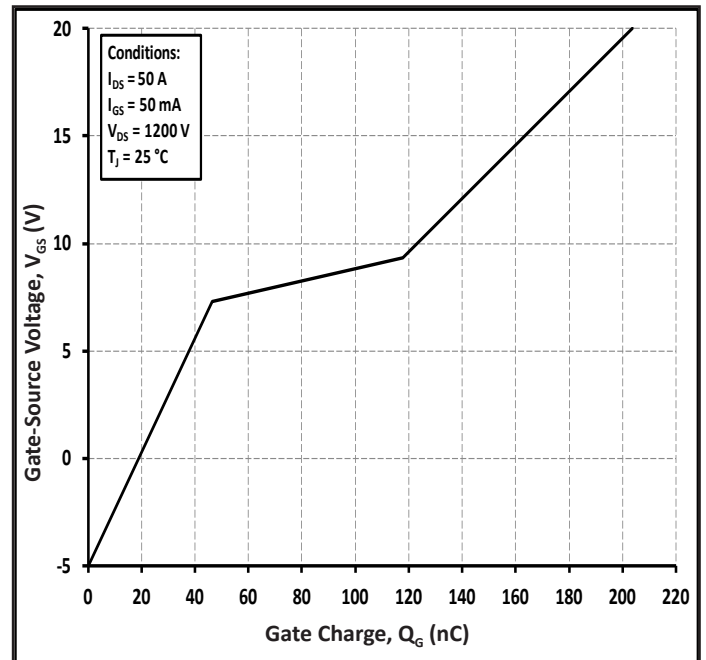

Figure 12. Gate Charge Characteristic

Typical Performance

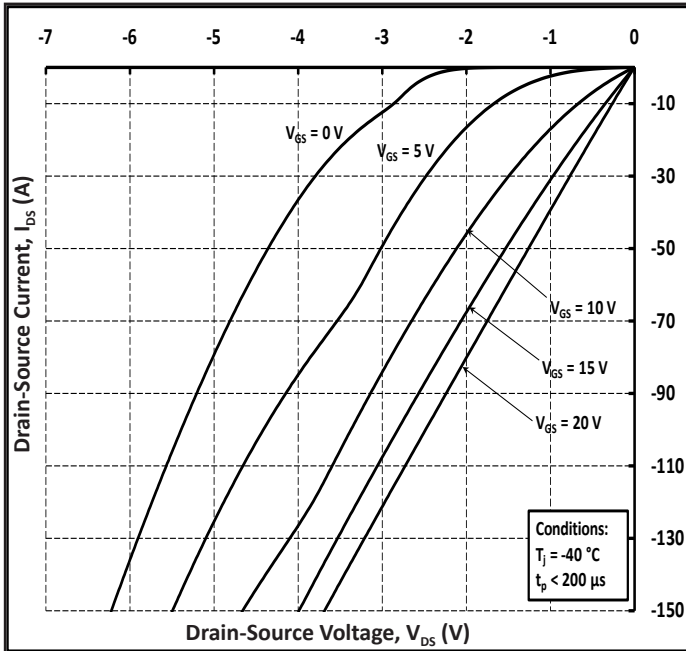

Figure 13. 3<sup>rd</sup> Quadrant Characteristic at  $-40\text{ }^{\circ}\text{C}$

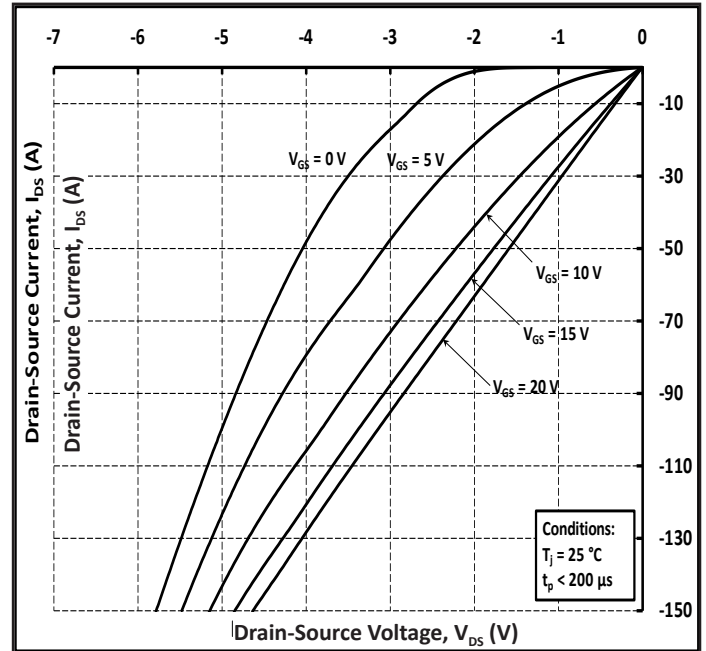

Figure 14. 3<sup>rd</sup> Quadrant Characteristic at  $25\text{ }^{\circ}\text{C}$

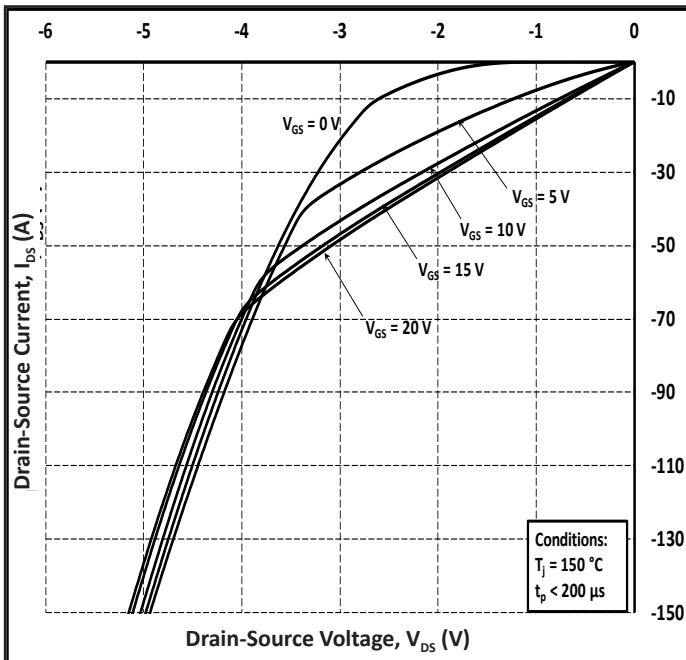

Figure 15. 3<sup>rd</sup> Quadrant Characteristic at  $150\text{ }^{\circ}\text{C}$

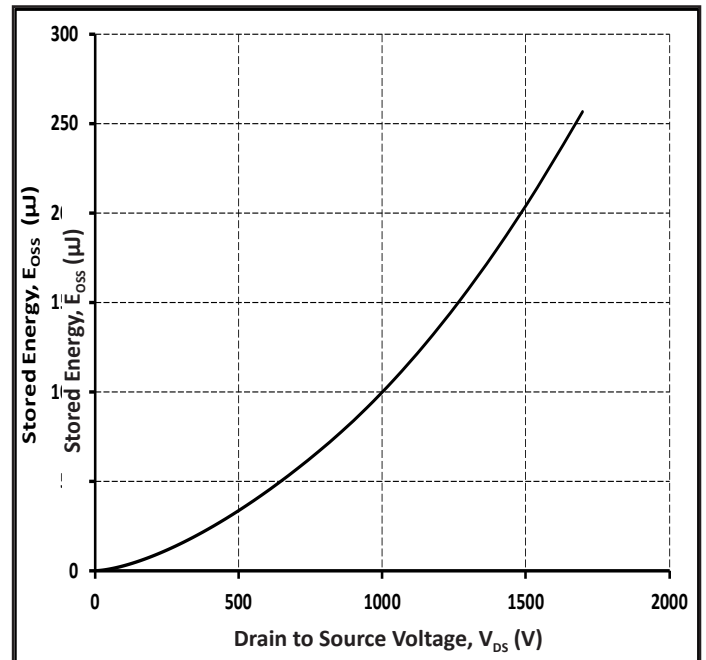

Figure 16. Output Capacitor Stored Energy



Typical Performance

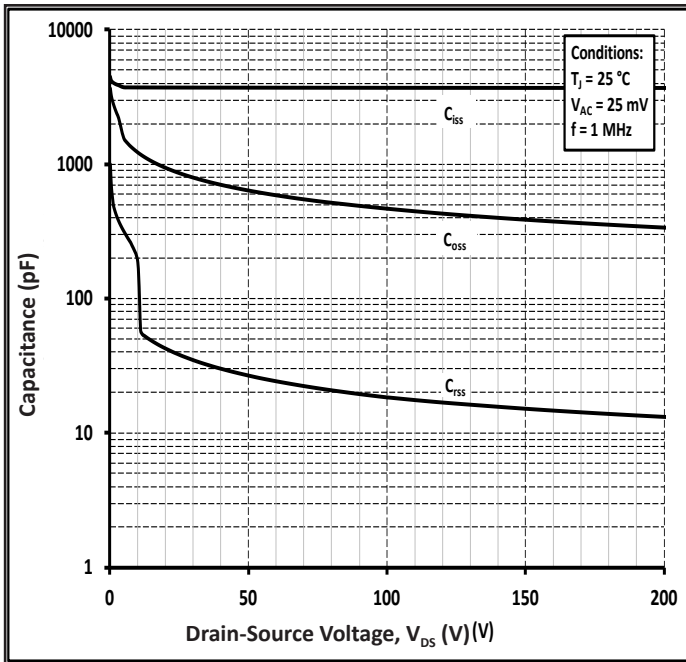

Figure 17. Capacitances vs Drain-Source Voltage (0-200 V)

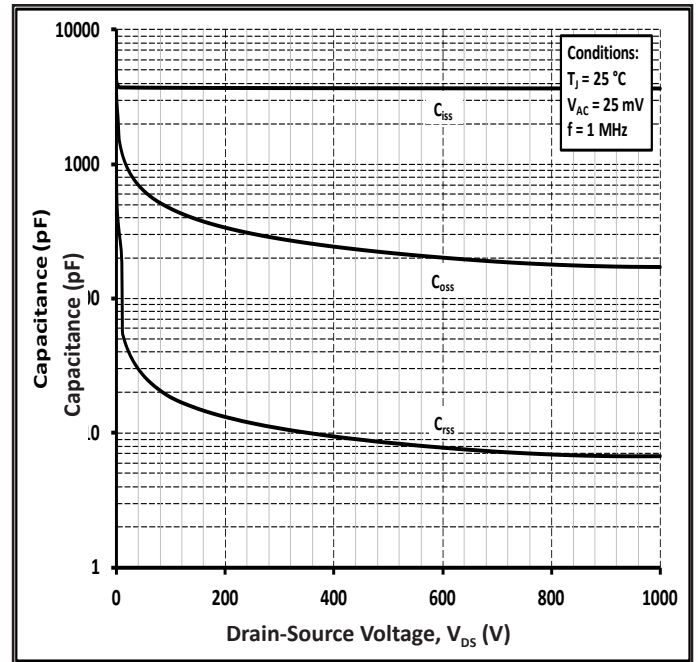

Figure 18. Capacitances vs Drain-Source Voltage (0-1000 V)

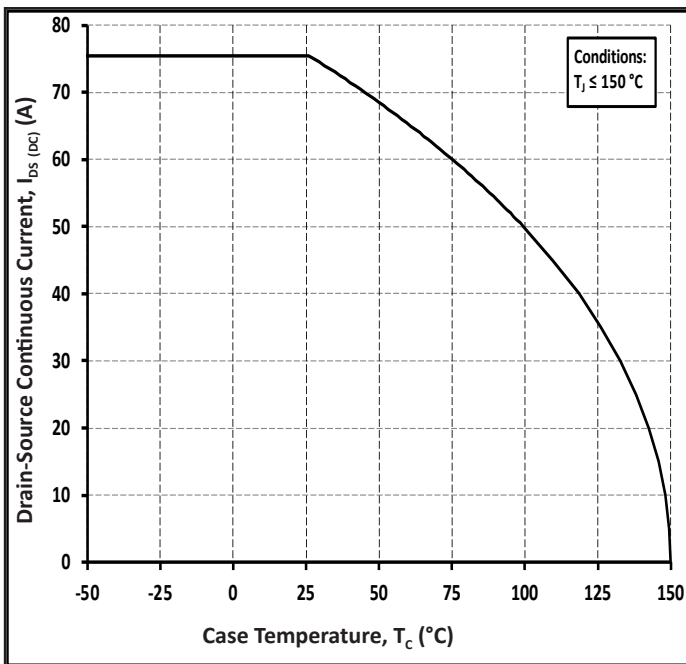

Figure 19. Continuous Drain Current Derating vs Case Temperature

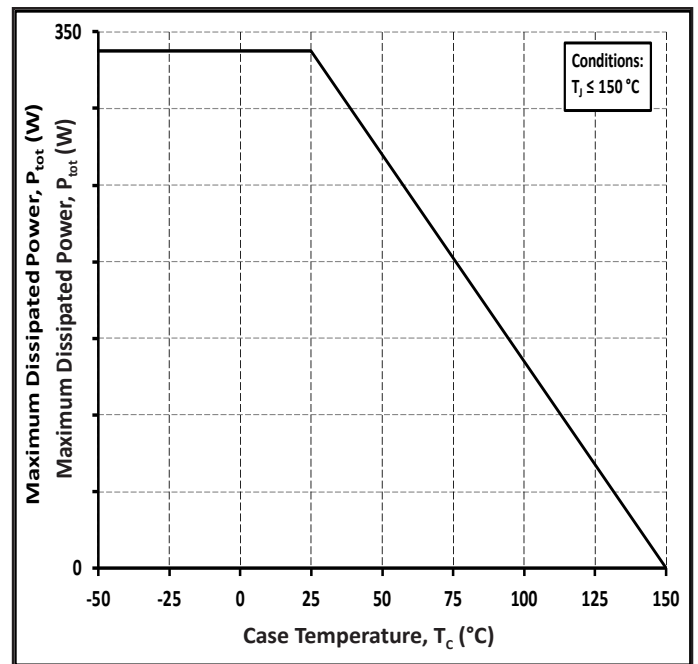

Figure 20. Maximum Power Dissipation Derating vs Case Temperature





Typical Performance

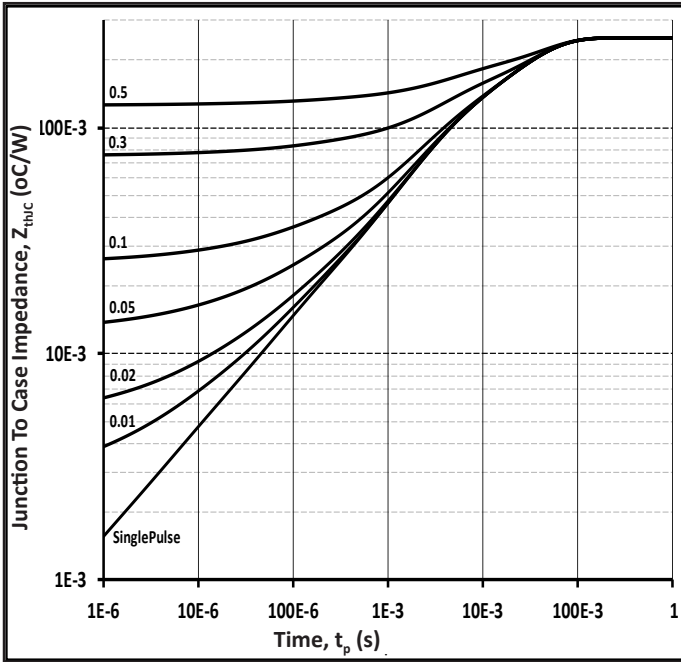

Figure 21. Transient Thermal Impedance (Junction - Case)

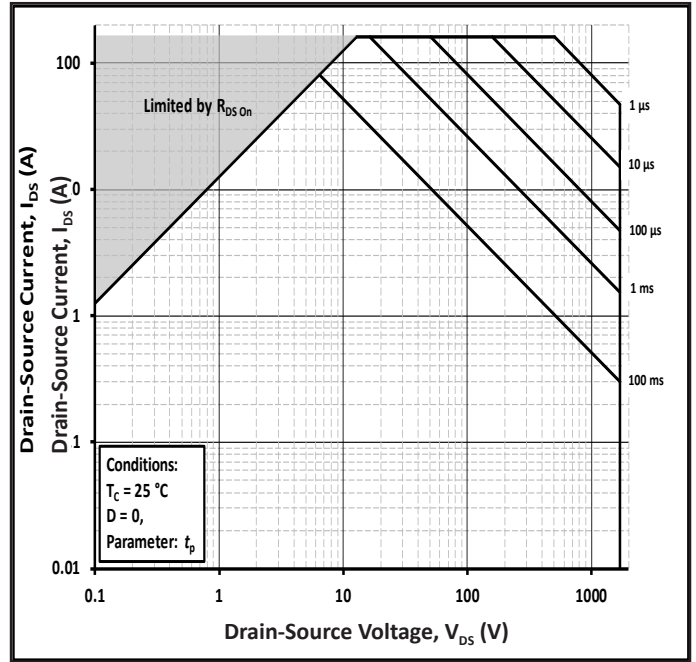

Figure 22. Safe Operating Area

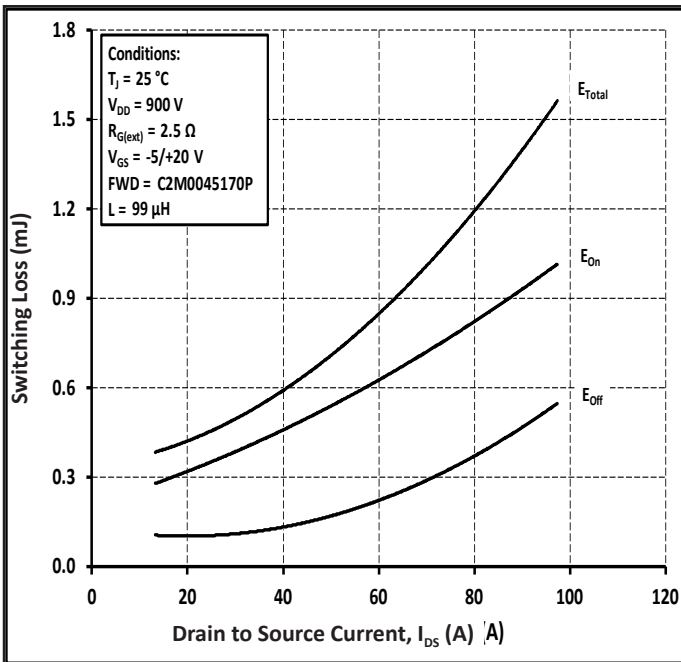

Figure 23. Clamped Inductive Switching Energy vs Drain Current ( $V_{DD} = 900\text{ V}$ )

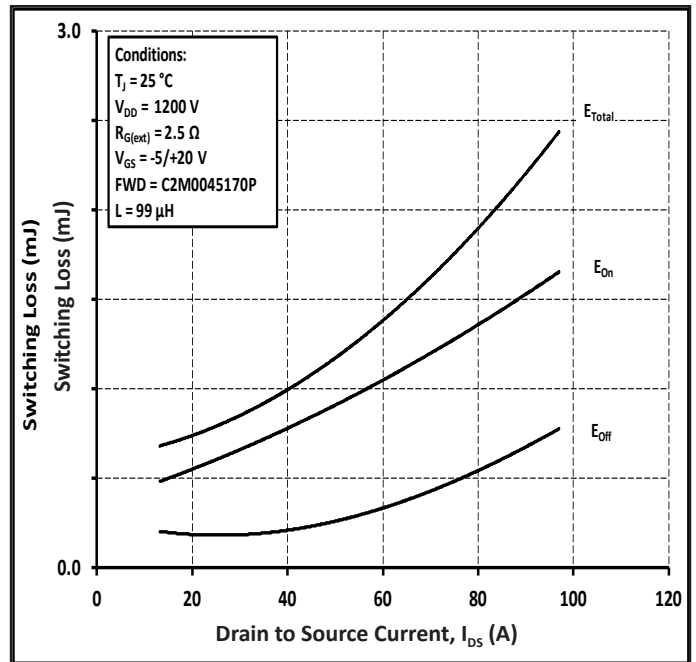

Figure 24. Clamped Inductive Switching Energy vs Drain Current ( $V_{DD} = 1200\text{ V}$ )



Typical Performance

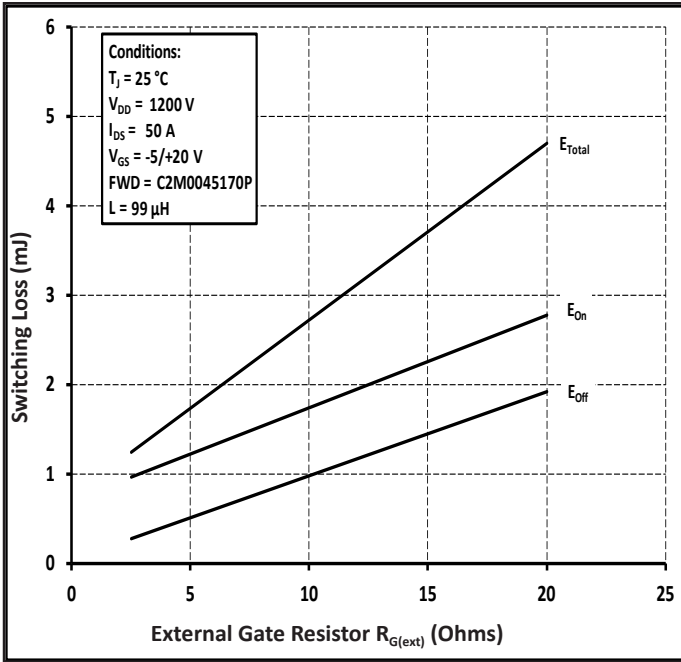

Figure 25. Clamped Inductive Switching Energy vs  $R_{G(ext)}$

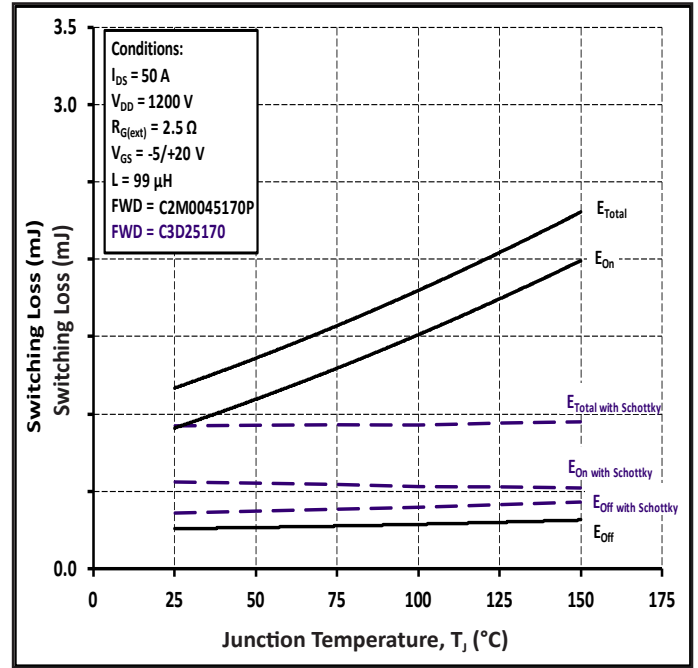

Figure 26. Clamped Inductive Switching Energy vs Temperature

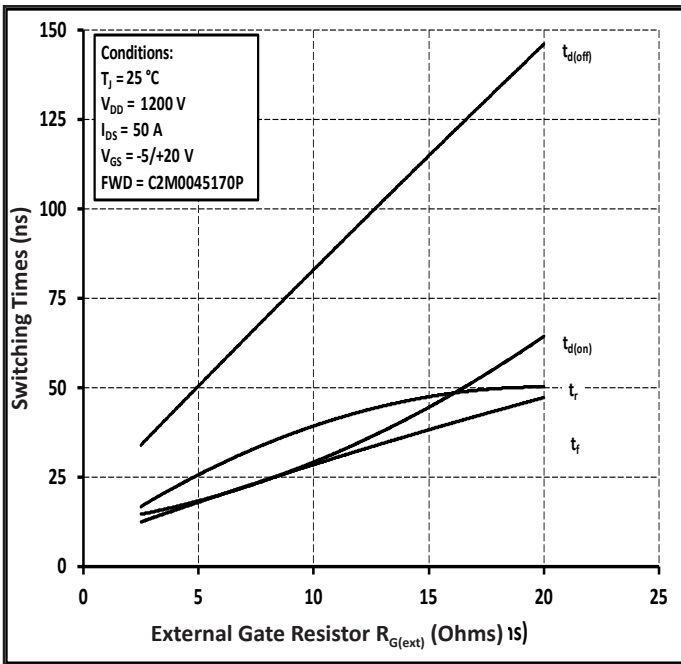

Figure 27. Switching Times vs  $R_{G(ext)}$

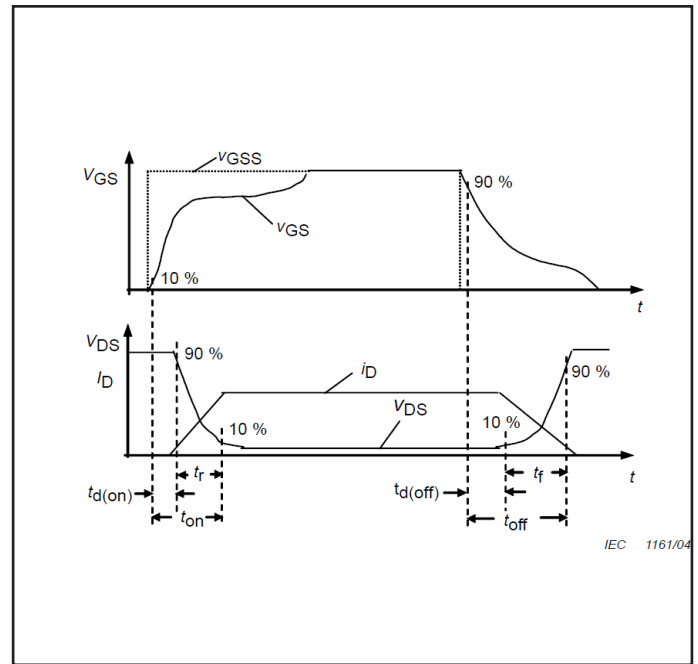

Figure 28. Switching Times Definition



**Test Circuit Schematic**

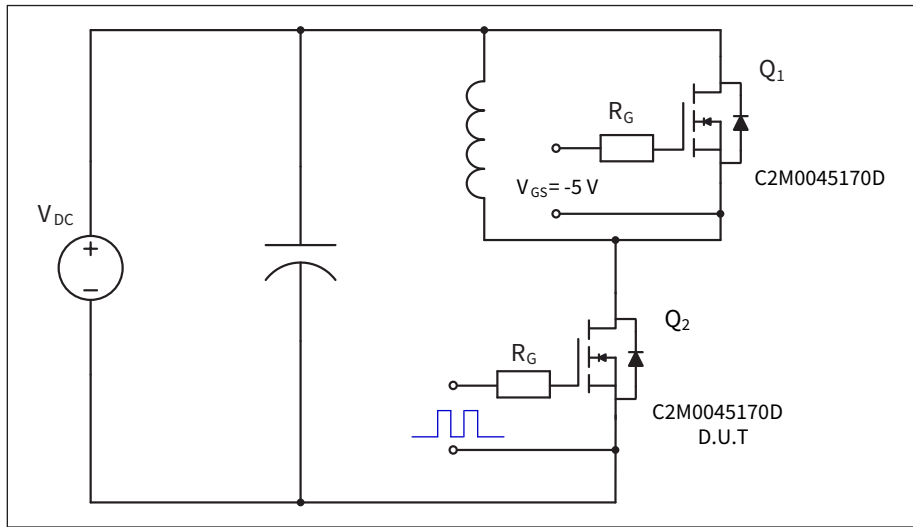

Figure 29a. Clamped Inductive Switching Test Circuit Using MOSFET Intrinsic Body Diode

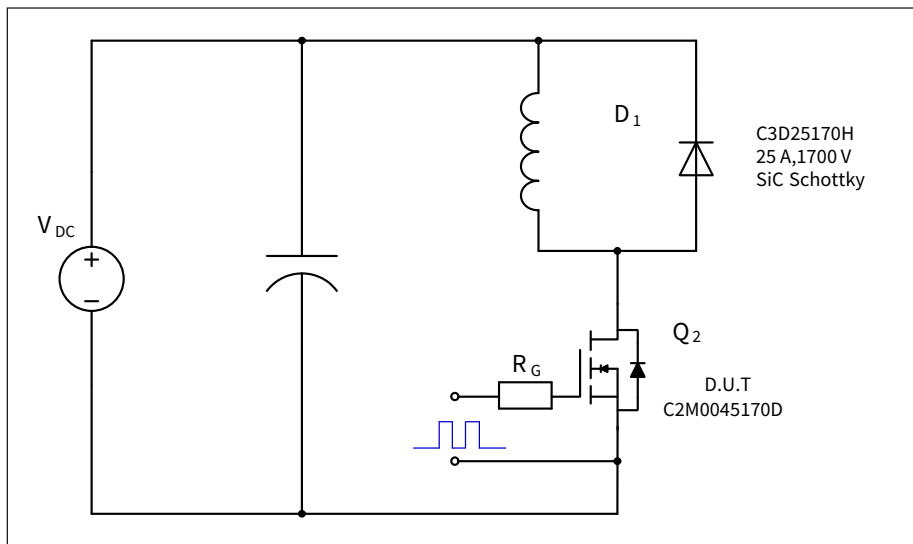
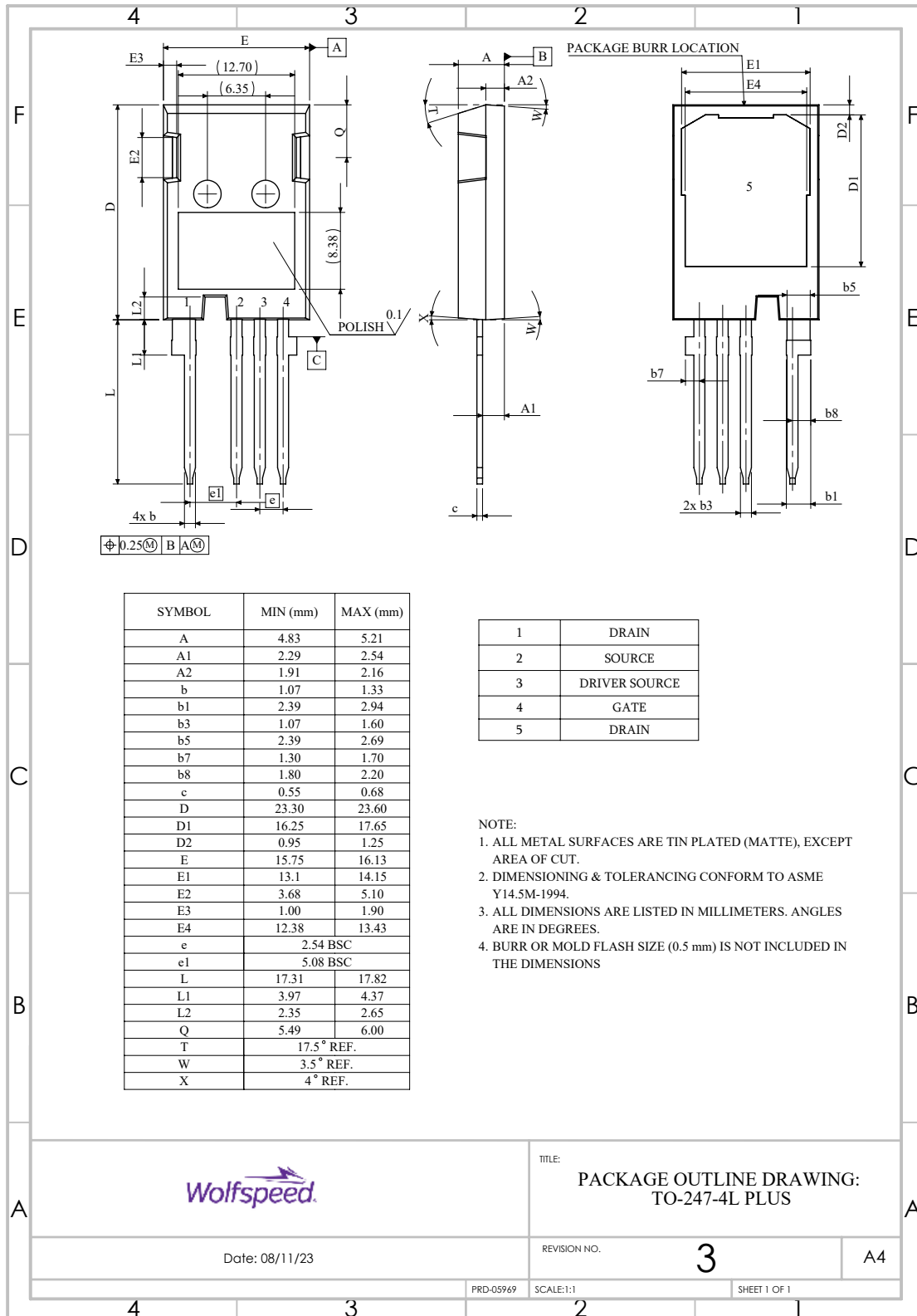

Figure 29b. Clamped Inductive Switching Test Circuit Using SiC Schottky Diode



### Package Dimensions

Package: TO-247-4L





**Recommended Solder Pad Layout**

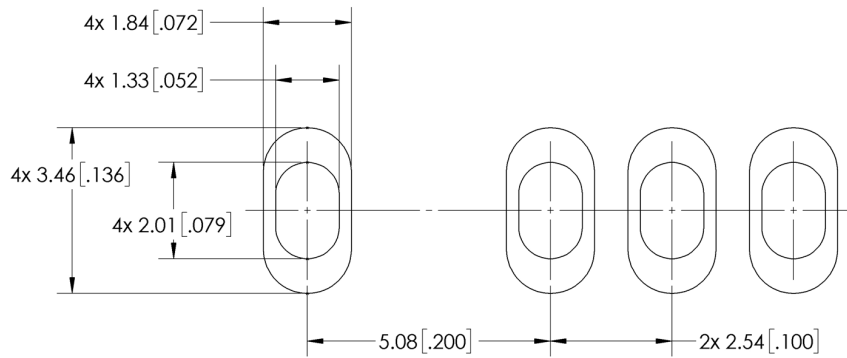

Part Number	Package	Marking
C2M0045170P	TO-247-4L	C2M0045170P



## Revision History

Current Revision	Date of Release	Description of Changes
2	May-2022	Initial Release
3	October-2023	Wolfspeed branding, POD, Package image, Solder Temp conditions note changed to JEDEC standard
4	November-2023	Corrected POD A1, D2, and L



## Notes & Disclaimer

---

This document and the information contained herein are subject to change without notice. Any such change shall be evidenced by the publication of an updated version of this document by Wolfspeed. No communication from any employee or agent of Wolfspeed or any third party shall effect an amendment or modification of this document. No responsibility is assumed by Wolfspeed for any infringement of patents or other rights of third parties which may result from use of the information contained herein. No license is granted by implication or otherwise under any patent or patent rights of Wolfspeed.

Notwithstanding any application-specific information, guidance, assistance, or support that Wolfspeed may provide, the buyer of this product is solely responsible for determining the suitability of this product for the buyer's purposes, including without limitation for use in the applications identified in the next bullet point, and for the compliance of the buyers' products, including those that incorporate this product, with all applicable legal, regulatory, and safety-related requirements.

This product has not been designed or tested for use in, and is not intended for use in, applications in which failure of the product would reasonably be expected to cause death, personal injury, or property damage, including but not limited to equipment implanted into the human body, life-support machines, cardiac defibrillators, and similar emergency medical equipment, aircraft navigation, communication, and control systems, aircraft power and propulsion systems, air traffic control systems, and equipment used in the planning, construction, maintenance, or operation of nuclear facilities.

### RoHS Compliance

The levels of RoHS restricted materials in this product are below the maximum concentration values (also referred to as the threshold limits) permitted for such substances, or are used in an exempted application, in accordance with EU Directive 2011/65/EC (RoHS2), as implemented January 2, 2013. RoHS Declarations for this product can be obtained from your Wolfspeed representative or from the Product Documentation sections of [www.wolfspeed.com](http://www.wolfspeed.com).

### REACH Compliance

REACH substances of high concern (SVHCs) information is available for this product. Since the European Chemical Agency (ECHA) has published notice of their intent to frequently revise the SVHC listing for the foreseeable future, please contact your Wolfspeed representative to ensure you get the most up-to-date REACH SVHC Declaration. REACH banned substance information (REACH Article 67) is also available upon request.

### Contact info:

4600 Silicon Drive  
Durham, NC 27703 USA  
Tel: +1.919.313.5300  
[www.wolfspeed.com/power](http://www.wolfspeed.com/power)