



MagAlpha MA735

9- to 13-Bit, Digital, Contactless Angle Sensor with ABZ and PWM Outputs in an Ultra-Small UTQFN-14 Package

DESCRIPTION

The MA735 detects the absolute angular position of a permanent magnet, typically a diametrically magnetized cylinder on a rotating shaft. Its ultra-small UTQFN (2mmx2mm) package makes it an ideal solution for space-constrained applications. Fast data acquisition and processing provide accurate angle measurements at speeds from 0rpm to 60,000rpm. The digital filtering is adjustable to optimize control loop performance when used in servo applications.

The MA735 supports a wide range of magnetic field strengths and spatial configurations. Both end-of-shaft and off-axis (side-shaft mounting) configurations are supported.

The MA735 features magnetic field strength detection with configurable thresholds to allow sensing of the magnet position relative to the sensor for creation of functions, such as the sensing of axial movements or for diagnostics.

The on-chip, non-volatile memory (NVM) provides storage for configuration parameters, including the reference zero-angle position, ABZ encoder settings, and magnetic field detection thresholds.

FEATURES

- 9-Bit to 13-Bit, $\pm 3\sigma$ Resolution Absolute Angle Encoder
- Contactless Sensing for Long Life
- SPI Serial Interface for Digital Angle Readout and Chip Configuration
- Incremental 12-Bit ABZ Quadrature Encoder Interface with Configurable Pulses per Turn from 1 to 1024
- 14-Bit Pulse-Width Modulation (PWM) Output
- Configurable Magnetic Field Strength Detection for Diagnostics
- 3.3V, 12mA Supply
- -40°C to $+125^{\circ}\text{C}$ Operating Temperature Range
- Available in an Ultra-Small UTQFN-14 (2mmx2mm) Package

APPLICATIONS

- General-Purpose Angle Measurements
- High-Resolution Angle Encoders
- Automotive Angle Sensing
- Robotics

All MPS parts are lead-free, halogen-free, and adhere to the RoHS directive. For MPS green status, please visit the MPS website under Quality Assurance. "MPS", the MPS logo, and "Simple, Easy Solutions" are registered trademarks of Monolithic Power Systems, Inc. or its subsidiaries.

TYPICAL APPLICATION

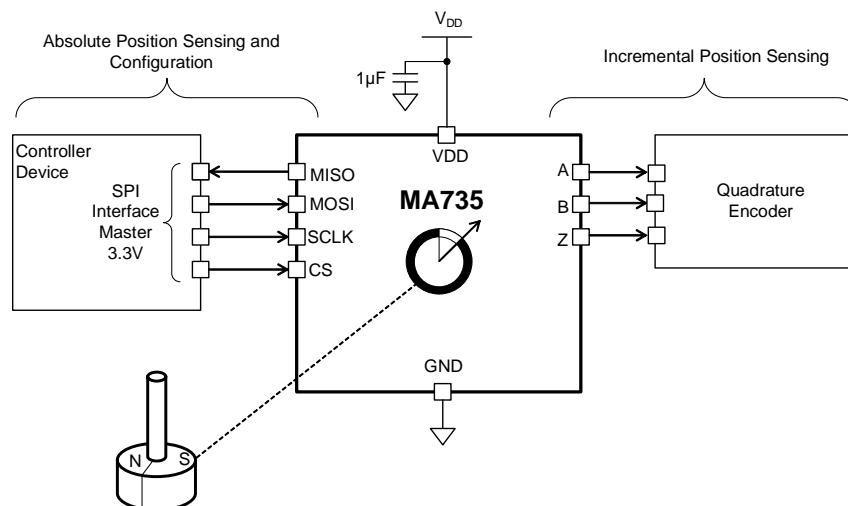

ORDERING INFORMATION

Part Number*	Package	Top Marking	MSL Rating
MA735GGU	UTQFN-14 (2mmx2mm)	See Below	1

* For Tape & Reel, add suffix -Z (e.g. MA735GGU-Z).

TOP MARKING

MUY

LLLL

MU: Product code of MA735GGU

Y: Year code

LLLL: Lot number

PACKAGE REFERENCE

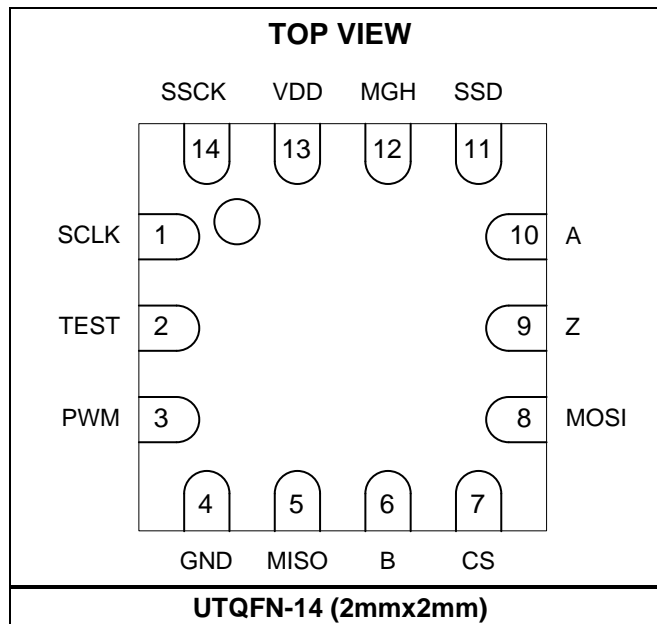

PIN FUNCTIONS

Pin #	Name	Description
1	SCLK	Clock (SPI). The SCLK pin has an internal pull-down resistor.
2	TEST	Factory use only. Connect the TEST pin to ground.
3	PWM	Pulse-width modulation output.
4	GND	Supply ground.
5	MISO	Data out (SPI). The MISO pin has an internal pull-down resistor that is enabled at a high-impedance (Hi-Z) state.
6	B	Incremental output.
7	CS	Chip select (SPI). The CS pin has an internal pull-up resistor.
8	MOSI	Data in (SPI). The MOSI pin has an internal pull-down resistor.
9	Z	Incremental output.
10	A	Incremental output.
11	SSD	Data out (SSI).
12	MGH	Digital output indicating field strength above the MGHT level.
13	VDD	3.3V supply. Bypass the VDD pin using a 1 μ F capacitor, placed as close to the package as possible.
14	SCLK	Clock (SSI). The SCLK pin has an internal pull-down resistor.

ABSOLUTE MAXIMUM RATINGS ⁽¹⁾

Supply voltage (V_{DD})	-0.5V to +4.6V
Input pin voltage (V_{IN})	-0.5V to +6V
Output pin voltage (V_{OUT})	-0.5V to +4.6V
Continuous power dissipation ($T_A = 25^\circ\text{C}$) ⁽²⁾	2W
Junction temperature	160°C
Lead temperature	260°C
Storage temperature	-65°C to +150°C

ESD Ratings

Human body model (HBM)	$\pm 2\text{kV}$
Charged device model (CDM)	$\pm 750\text{V}$

<i>Thermal Resistance</i> ⁽³⁾	θ_{JA}	θ_{JC}
UTQFN-14 (2mmx2mm)	90	20

Notes:

- Exceeding these ratings may damage the device.
- The maximum allowable power dissipation is a function of the maximum junction temperature T_J (MAX), the junction-to-ambient thermal resistance θ_{JA} , and the ambient temperature T_A . The maximum allowable continuous power dissipation at any ambient temperature is calculated by P_D (MAX) = $(T_J$ (MAX) - T_A) / θ_{JA} .
- Measured on JESD51-7, 4-layer PCB.

ELECTRICAL CHARACTERISTICS

Parameter	Symbol	Condition	Min	Typ	Max	Units
Recommended Operating Conditions						
Supply voltage	V _{DD}		3	3.3	3.6	V
Supply current	I _{DD}	T _A = -40°C +125°C	10.2	11.7	13.8	mA
Operating temperature	T _A		-40		+125	°C
Applied magnetic field	B		40	60		mT

GENERAL CHARACTERISTICS

$V_{DD} = 3.3V$, $45mT < B < 100mT$, $T_A = -40^{\circ}C$ to $+125^{\circ}C$, unless otherwise noted.

Parameter	Symbol	Condition	Min	Typ	Max	Units
Absolute Output – Serial						
Resolution ($\pm 3\sigma$)		Filter window $\tau = 64\mu s$	8.2	9		bits
		Filter window $\tau = 16ms$	12	13		bits
Noise RMS		Filter window $\tau = 64\mu s$		0.12	0.2	deg
		Filter window $\tau = 16ms$		0.007	0.01	deg
Refresh rate ⁽⁴⁾			850	980	1100	kHz
Data output length ⁽⁴⁾			16		16	bits
Response Time						
Start-up time ⁽⁴⁾		Filter window $\tau = 64\mu s$			0.6	ms
		Filter window $\tau = 16ms$			260	ms
Latency ⁽⁴⁾		Constant speed propagation delay	8		10	μs
Filter cutoff frequency	f_{CUTOFF}	Filter window $\tau = 64\mu s$		6		kHz
		Filter window $\tau = 16ms$		23		Hz
Accuracy						
INL accuracy		$T_A = 25^{\circ}C$, at room temperature across the entire field range		0.7		deg
		$T_A = -40^{\circ}C$ to $+125^{\circ}C$, across the entire temperature range and field range		1.1		deg
Output Drift						
Temperature induced drift		At room temperature		0.015		deg/ $^{\circ}C$
Temperature induced variation		$T_A = 25^{\circ}C$ to $85^{\circ}C$		0.5		deg
		$T_A = 25^{\circ}C$ to $125^{\circ}C$		1		deg
Magnetic field induced				0.005		deg/mT
Voltage supply induced ⁽⁴⁾					0.3	deg/V
Absolute Output – Pulse-Width Modulation (PWM)						
PWM frequency	f_{PWM}		840	970	1090	Hz
PWM resolution			13	13.8	14	bits
Incremental Output – ABZ						
ABZ update rate				16		MHz
Resolution (edges per turn)		Configurable	4		4096	
Pulses per channel per turn	PPT + 1	Configurable	1		1024	
ABZ hysteresis ⁽⁴⁾	H	Configurable	0.08		2.8	deg
Systematic jitter ⁽⁴⁾		PPT = 1023, up to 60mT			11	%
		PPT = 127			7	%

GENERAL CHARACTERISTICS (continued)
 $V_{DD} = 3.3V$, $45mT < B < 100mT$, $T_A = -40^{\circ}C$ to $+125^{\circ}C$, unless otherwise noted.

Parameter	Symbol	Condition	Min	Typ	Max	Units
Magnetic Field Detection Thresholds						
Accuracy				5		mT
Hysteresis	MagHys			6		mT
Temperature drift				-600		ppm/°C
Digital I/O						
Input high voltage	V_{IN_HIGH}		2.5		5.5	V
Input low voltage	V_{IN_LOW}		-0.3		0.8	V
Output low voltage ⁽⁴⁾	V_{OUT_LOW}	$I_{OUT_LOW} = 4mA$			0.4	V
Output high voltage ⁽⁴⁾	V_{OUT_HIGH}	$I_{OUT_HIGH} = 4mA$	2.4			V
Pull-up resistor	R_{PU}	$V_{IN} = 0V$	46	66	97	kΩ
Pull-down resistor	R_{PD}	$V_{IN} = 3.3V$	25	35	97	kΩ
Rising edge slew rate	t_{RISING}	$C_{LOAD} = 50pF$		0.7		V/ns
Falling edge slew rate	$t_{FALLING}$	$C_{LOAD} = 50pF$		0.7		V/ns

Note:

4) Guaranteed by design and characterization.

TYPICAL CHARACTERISTICS

$V_{DD} = 3.3V$, $T_A = 25^\circ C$, unless otherwise noted.

ABZ Jitter

PPT = 255, $\tau = 16ms$

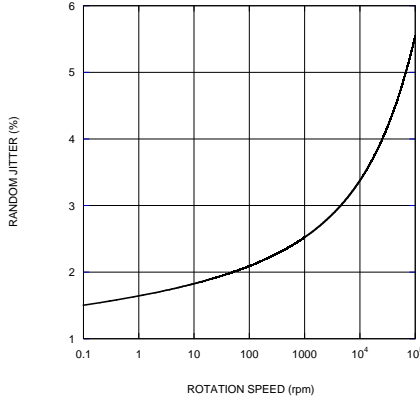

Supply Current vs. Temperature

$V_{DD} = 3.3V$

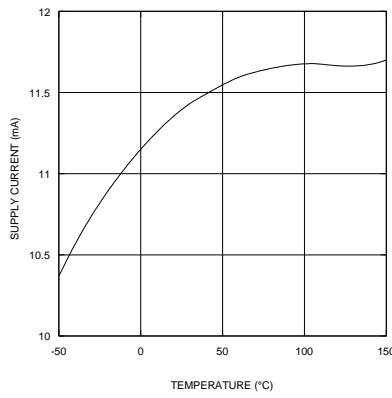

Filter Transfer Function vs. Frequency

$\tau = 16ms$

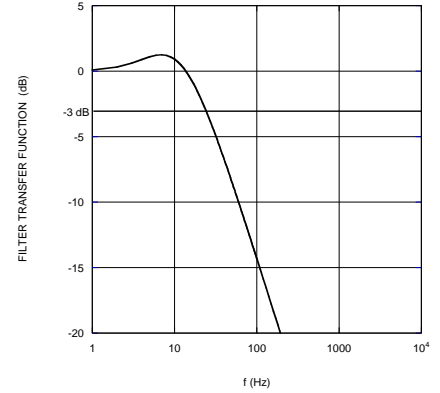

Error Curves

50mT

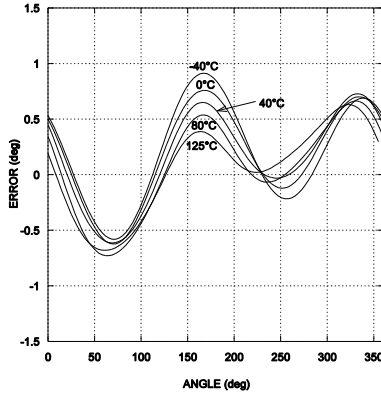

Nonlinearity (INL and Harmonics)

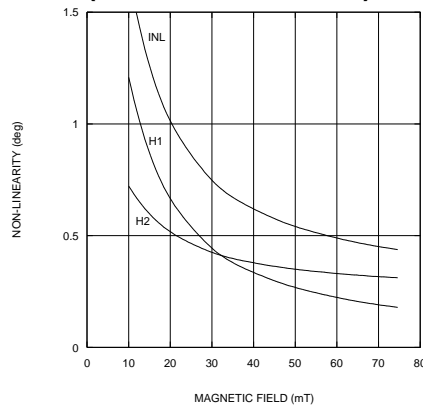

Noise Spectrum

50mT, $\tau = 16ms$

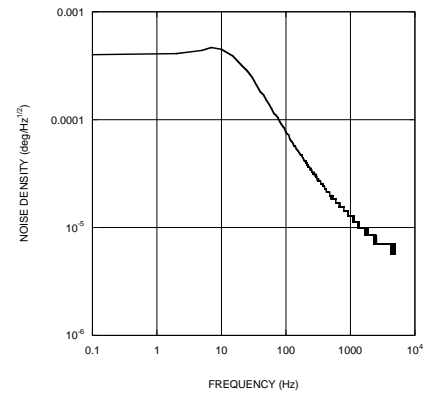

FUNCTIONAL BLOCK DIAGRAM

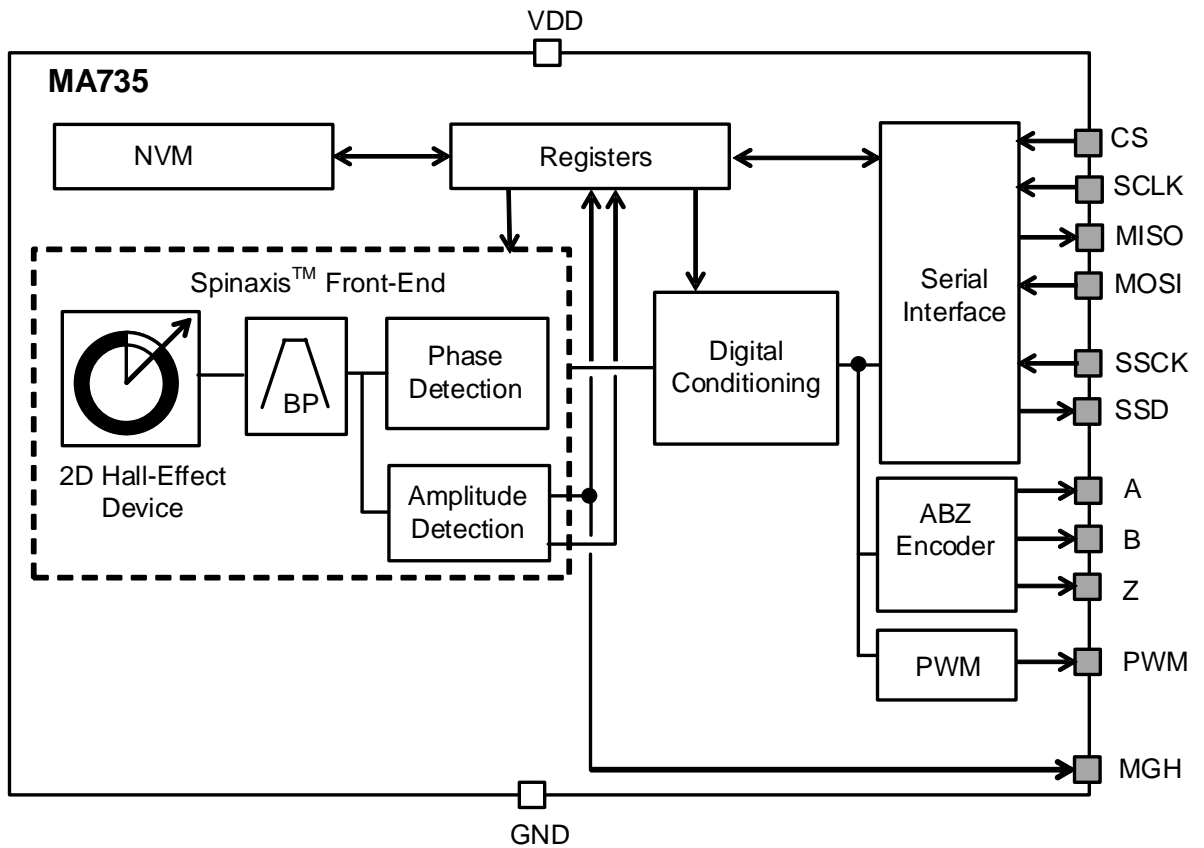

Figure 1: Functional Block Diagram

OPERATION

Sensor Front End

The magnetic field is detected with integrated Hall devices located in the center of the package. The angle is measured using MPS’s proprietary Spinaxis™ method, which digitizes the direction of the field directly without complex arctangent computations or feedback loop-based circuits (interpolators).

The Spinaxis™ method is based on phase detection, and generates a sinusoidal signal with a phase that represents the angle of the magnetic field. The angle is then obtained by a time-to-digital converter, which measures the time between the zero crossing of the sinusoidal signal and the edge of a constant waveform (see Figure 2). The time-to-digital is the output from the front-end to the digital conditioning block.

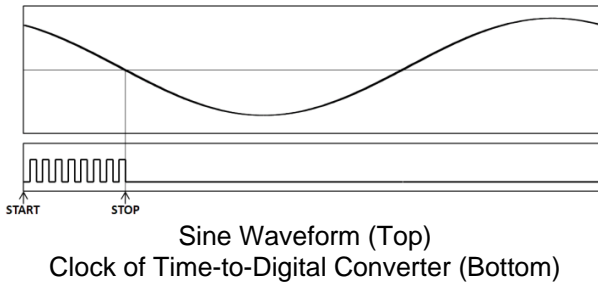

Figure 2: Phase Detection Method

The output of the front end delivers a digital number proportional to the angle of the magnetic field at a rate of 1MHz in a straightforward, open-loop manner.

Digital Filtering

The front-end signal is further treated to achieve the final resolution. This treatment does not add any latency under steady conditions. The filter transfer function can be calculated with Equation (1):

$$H(s) = \frac{1 + 2Ts}{(1 + Ts)^2} \quad (1)$$

Where τ is the filter time constant related to the cutoff frequency ($\tau = 0.38 / f_{\text{CUTOFF}}$). See the General Characteristics section on page 5 for the value of f_{CUTOFF} .

Sensor Magnet Mounting

The sensitive volume of the MA735 is confined to a region less than 100 μm wide, and has

multiple integrated Hall devices. This volume is located horizontally and vertically within 50 μm of the center of the UTQFN package. The sensor detects the angle of the magnetic field projected in a plane parallel to the package’s upper surface. This means that the only relevant magnetic field is the in-plane component (X and Y components) in the mid-point of the package.

By default, when looking at the top of the package, the angle increases while the magnetic field rotates clockwise. Figure 3 shows the zero angle of the non-configured sensor, where the plus sign (+) indicates the sensitive point. Both the rotation direction and the zero angle can be configured.

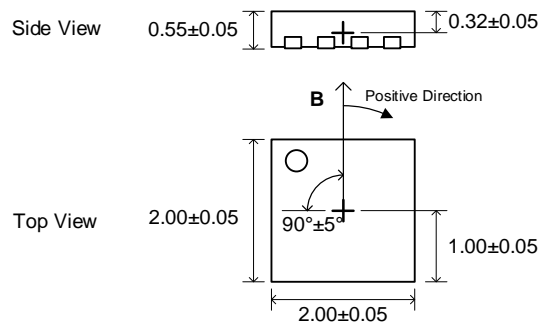

Figure 3: Detection Point and Default Positive Direction

This type of detection provides flexibility for the angular encoder design. The sensor requires only the magnetic vector to lie essentially within the sensor plane with a field amplitude of at least 40mT. The MA735 can work with fields smaller than 40mT, but the linearity and resolution performance may deviate from the specifications.

The most straightforward mounting method is to place the MA735 sensor on the rotation axis of a permanent magnet (e.g. a diametrically magnetized cylinder) (see Figure 4).

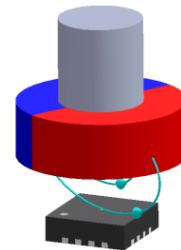

Figure 4: End-of-Shaft Mounting

The recommended magnet is a Neodymium alloy (N35) cylinder with dimensions of Ø5x3mm, inserted into an aluminum shaft with a 1.5mm air gap between the magnet and the sensor (surface of package). For good linearity, the sensor is positioned with a precision of 0.5mm.

If the end-of-shaft position is not available, the sensor can be positioned away from the rotation axis of a cylinder or ring magnet (see Figure 5).

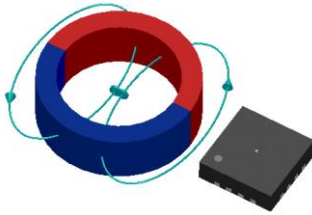

Figure 5: Side-Shaft Mounting

In this case, the magnetic field angle is not directly proportional to the mechanical angle. The MA735 can be adjusted to compensate for this effect and recover the linear relationship between the mechanical angle and the sensor output. With multiple pole pair magnets, the MA735 indicates multiple rotations for each mechanical turn.

Electrical Mounting and Power Supply Decoupling

It is recommended to place a 1µF decoupling capacitor close to the sensor with a low-impedance path to GND (see Figure 6).

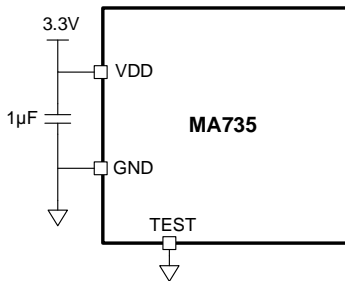

Figure 6: Supply Decoupling Connection

Serial Interface

The sensor supports the serial peripheral interface (SPI) standard for angle reading and register configuration. The SSI bus can also be used for angle reading (configuration via the SSI is not supported).

SPI

The SPI is a four-wire, synchronous, serial communication interface. The MA735 supports SPI Mode 3 and Mode 0 (see Table 1 and Table 2).

Table 1: SPI Specification

	Mode 0	Mode 3
SCLK Idle State	Low	High
Data Capture	On SCLK rising edge	
Data Transmission	On SCLK falling edge	
CS Idle State	High	
Data Order	MSB first	

Table 2: SPI Standard

	Mode 0	Mode 3
CPOL	0	1
CPHA	0	1
Data Order (DORD)	0 (MSB first)	

The SPI mode (0 or 3) is detected automatically by the sensor, and does not require additional action from the user. The maximum clock rate supported on the SPI is 25MHz. There is no minimum clock rate. Real-world data rates depend on the PCB layout quality and signal trace length. Figure 7 and Table 3 on page 11 show the SPI timing diagram and communication.

All commands to the MA735 (whether for writing or reading register content) must be transferred through the SPI MOSI pin, and must be 16 bits long. See the SPI Communication section on page 12 for details.

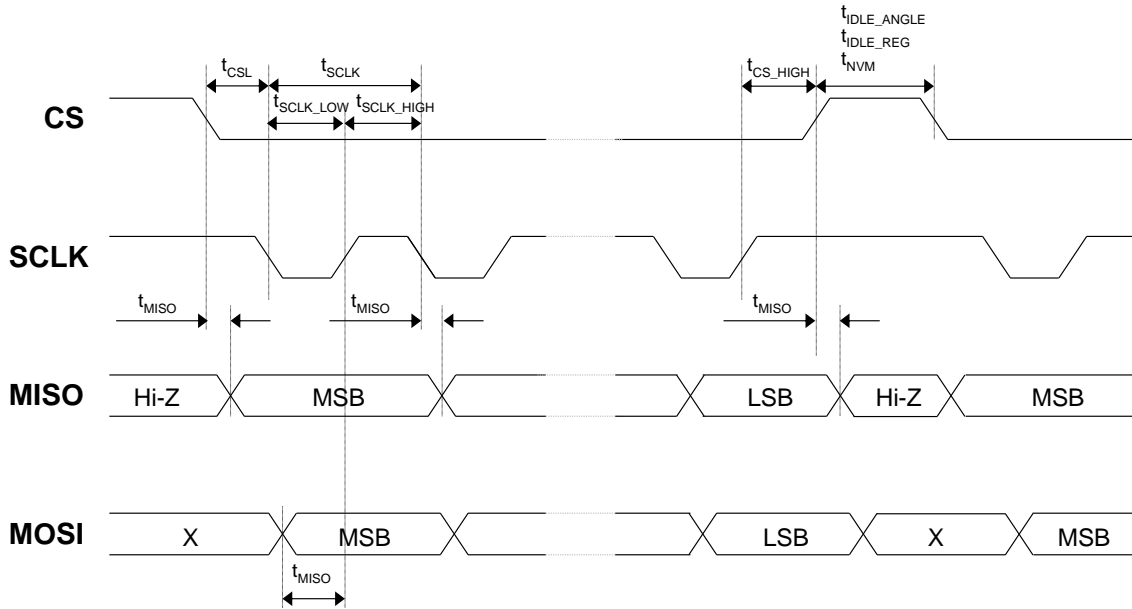
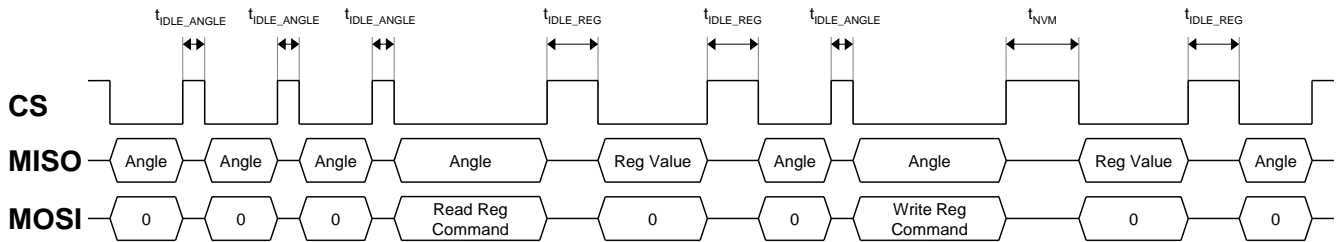
Figure 7: SPI Timing Diagram

Figure 8: Minimum Idle Time
Table 3: SPI Communication Timing

Parameter ⁽⁵⁾	Description	Min	Max	Unit
t_{IDLE_ANGLE}	Idle time between two subsequent angle transmissions	150	-	ns
t_{IDLE_REG}	Idle time before and after a register readout	750	-	ns
t_{NVM}	Idle time between a write command and a register readout (this delay is necessary for non-volatile memory updates)	20	-	ms
t_{CSL}	Time between the CS falling edge and the SCLK falling edge	80	-	ns
t_{SCLK}	SCLK period	40	-	ns
t_{SCLK_LOW}	Low level of the SCLK signal	20	-	ns
t_{SCLK_HIGH}	High level of the SCLK signal	20	-	ns
t_{CS_HIGH}	Time between the SCLK rising edge and the CS rising edge	25	-	ns
t_{MISO}	SCLK setting edge to data output valid	-	15	ns
t_{MOSI}	Data input valid to the SCLK reading edge	15	-	ns

Note:

5) Guaranteed by design.

SPI Communication

The MA735 supports three types of SPI operation:

- Read angle
- Read configuration register
- Write configuration register

Each operation has a specific frame structure, described below.

SPI Read Angle

New data is transferred into the output buffer every 1µs. The master device triggers the reading by pulling CS low.

If a trigger event is detected, then the data remains in the output buffer until the CS signal is de-asserted (see Table 4).

Table 4: Sensor Data Timing

Event	Action
CS falling edge	Starts reading and freezes the output buffer
CS rising edge	Releases the output buffer

Figure 9 shows a diagram for a full SPI angle reading.

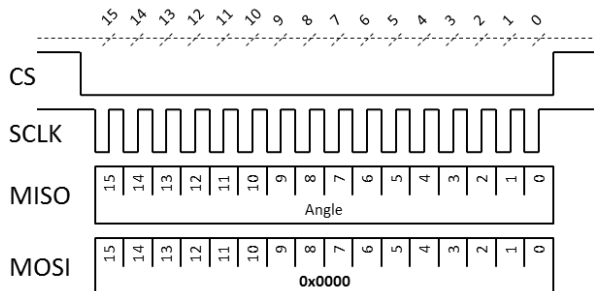

Figure 9: Full 16-Bit SPI Angle Reading

Figure 10 shows a partial SPI angle reading.

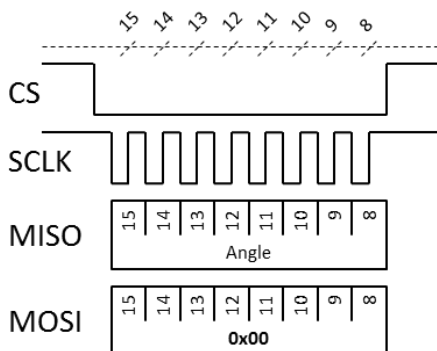
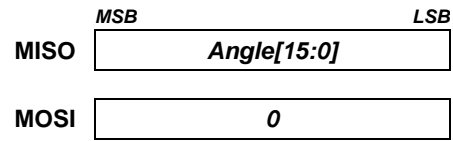
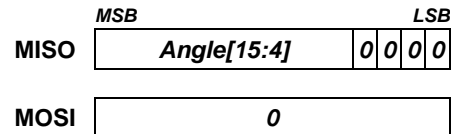

Figure 10: Partial 8-Bit SPI Angle Reading

A full angle reading requires 16 clock pulses. The sensor MISO line returns:



The MagAlpha family has sensors with different features and levels of resolution. See the General Characteristics section on page 5 for the number of useful bits delivered at the serial output. If the data length is smaller than 16, then the rest of the bits sent are zeros. For example, a data output length of 12 bits means the serial output delivers a 12-bit angle value with 4 bits of zeros padded at the end (the MISO state remains 0). If the master sends 16 clock counts, then the MA735 replies with:



Angle reading can be optimized without any information loss by reducing the number of clock counts. For a 12-bit data output length, only 12 clock counts are required for the full sensor resolution.

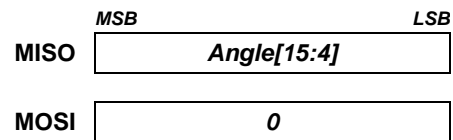

If less resolution is required, then the angle can be read by sending even fewer clock counts (since the MSB is first).

During fast reading, the MA735 continues sending the same data until the data refreshes. See the General Characteristics section on page 5 for details on the refresh rate.

SPI Read Register

A read register operation consists of two 16-bit frames. The first frame sends a read request, which contains the 3-bit read command (010) followed by the 5-bit register address. The last 8 bits of the frame should all be set to 0. The second frame returns the 8-bit register value (the MSB byte).

The first 16-bit SPI frame (read request) is:

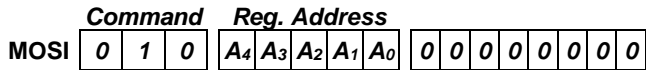
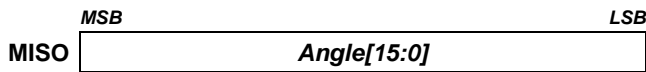

The second 16-bit SPI frame (response) is:

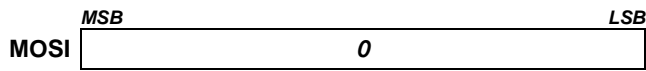
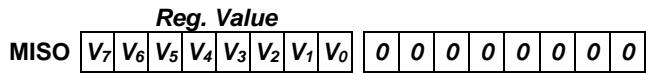
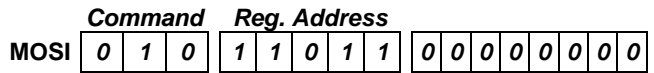
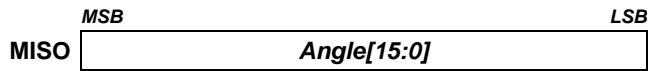

Figure 11 shows a complete transmission.

For example, to determine the value of the magnetic level high flag (MGL) and low flag

(MGL), read register 27 (bit[6], bit[7]) by sending the following first frame:



In the second frame, the MA735 replies:

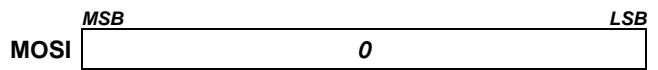
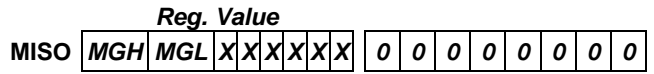

Figure 12 shows a complete example overview.

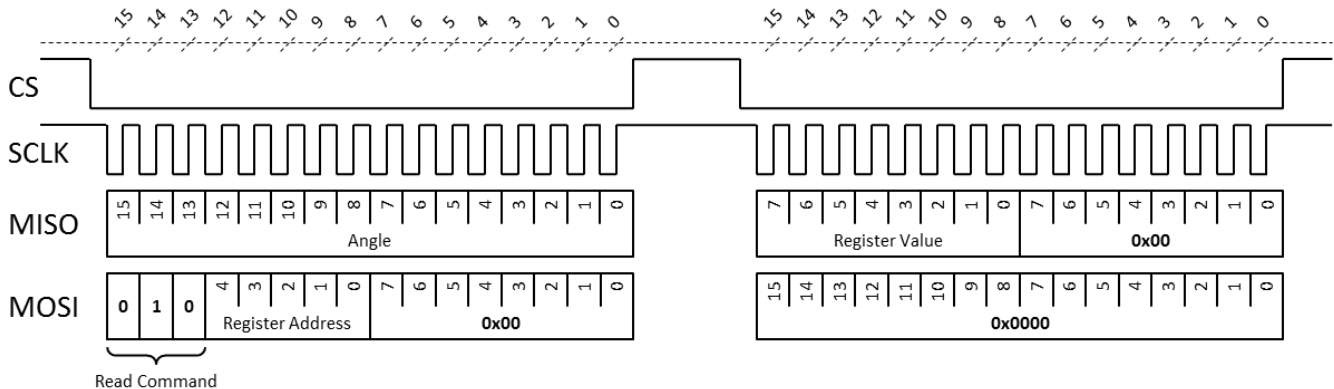

Figure 11: Read Register Operation with Two 16-Bit Frames

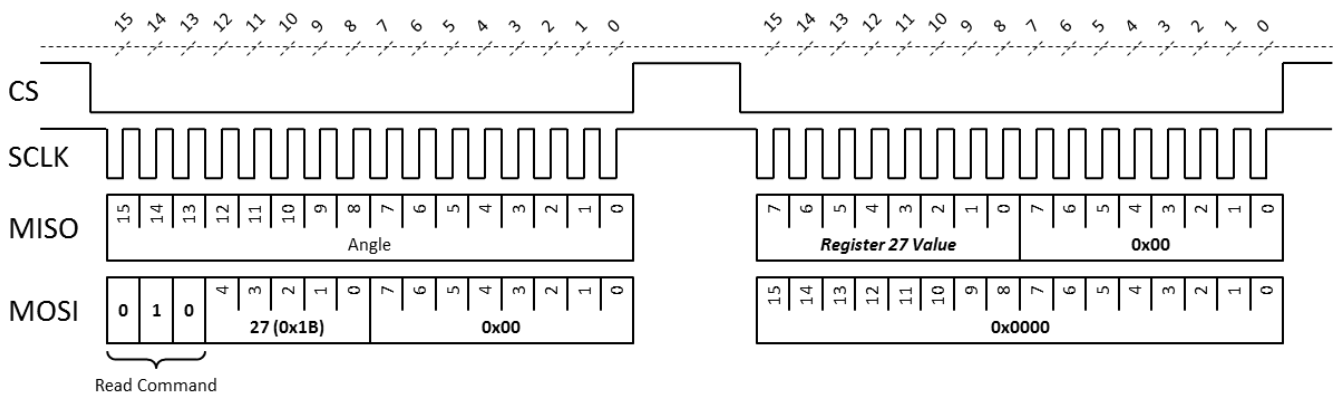

Figure 12: Example Read Magnetic Level High and Low Flags on Register 27 (Bit[6] and Bit[7])

SPI Write Register

Table 7 on page 17 shows the configurable 8-bit registers. Data written to these registers is stored in the on-chip, non-volatile memory (NVM) and is reloaded during start-up automatically. Table 8 on page 17 shows the default register values.

A write register operation is constituted of two 16-bit frames. The first frame sends a write request, which contains the 3-bit write command (100) followed by the 5-bit register address and the 8-bit value (MSB first). The second frame returns the newly written register value

(acknowledge). The on-chip NVM is guaranteed to endure 1,000 write cycles at 25°C.

It is critical to wait 20ms between the first and second frame. This is the time taken to write the NVM. Failure to implement this waiting period results in the register's previous value being read. Note that this delay is only required after a write request, and is not necessary for a read register request or read angle.

The first 16-bit SPI frame (write request) is:

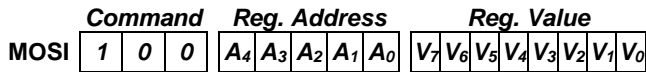
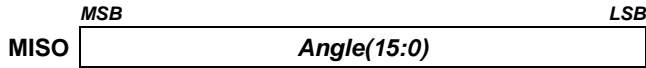

The second 16-bit SPI frame (response) is:

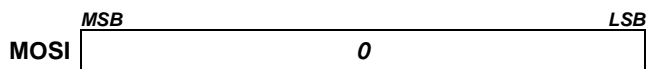
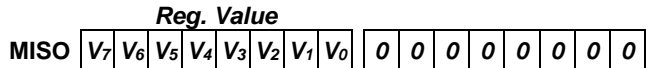

The readback register content can be used to verify the register configuration. Figure 13 shows a complete transmission overview.

For example, to set the value of the output rotation direction (RD) to counterclockwise (high), write register 9 by sending the following first frame:

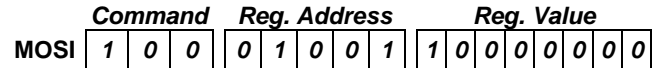
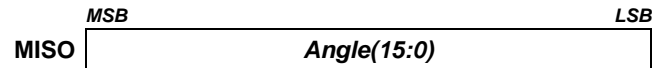

Send the second frame after a 20ms wait time (see Figure 8 on page 11). If the register is written correctly, the reply is:

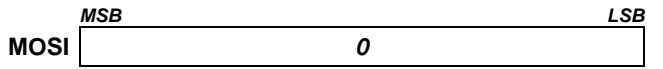
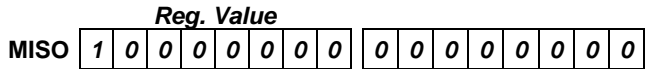

Figure 14 shows a complete example.

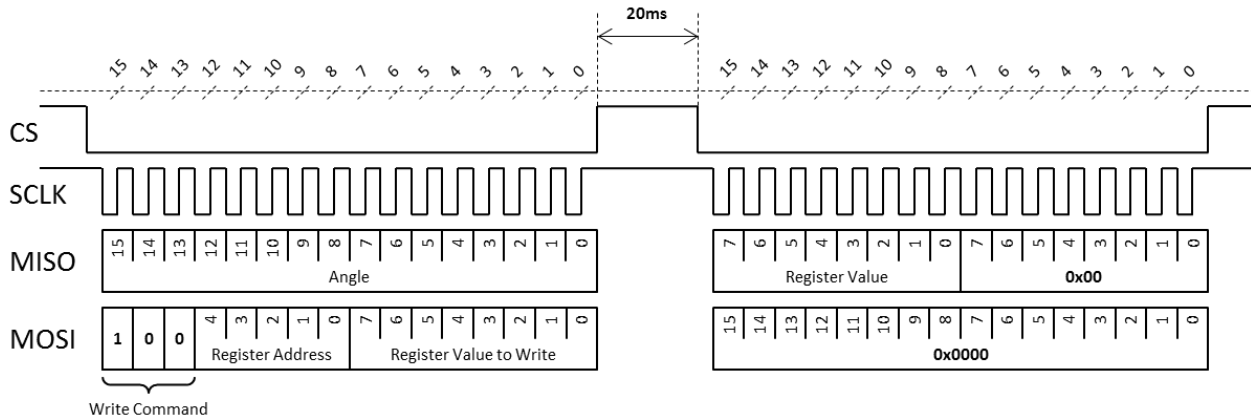

Figure 13: Write Register Operation with Two 16-Bit Frames

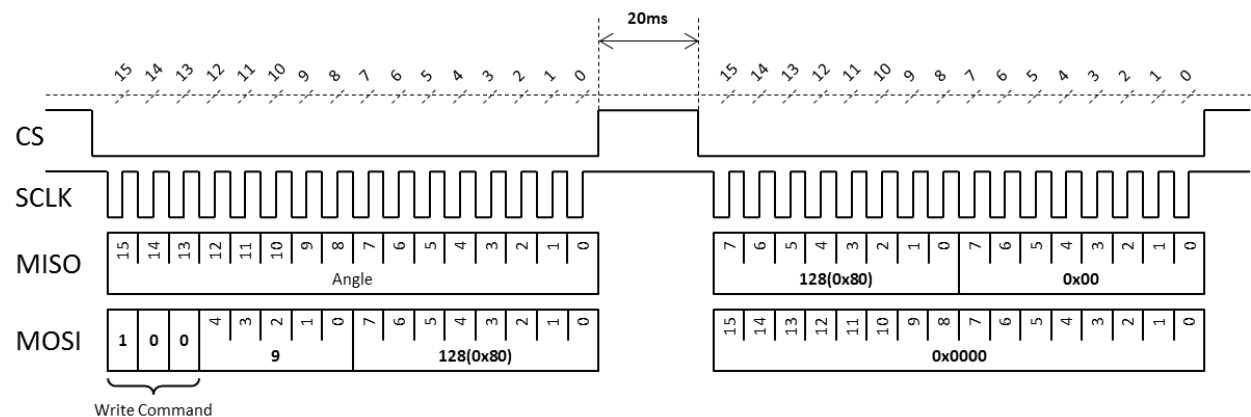

Figure 14: Example Write Output Rotation Direction to Counterclockwise (High) on Register 9 (Bit[7])

SSI

The SSI is a two-wire, synchronous serial interface for data reading only. The sensor operates as a slave to the external SSI master and only supports angle reading. It is not possible to read or write registers using SSI.

SSI Communication

Unlike the SPI, the sensor SSI only supports angle reading operation. It is not possible to read or write registers using the SSI. Figure 15 shows the SSI timing diagram. Table 5 show the SSI timing communication.

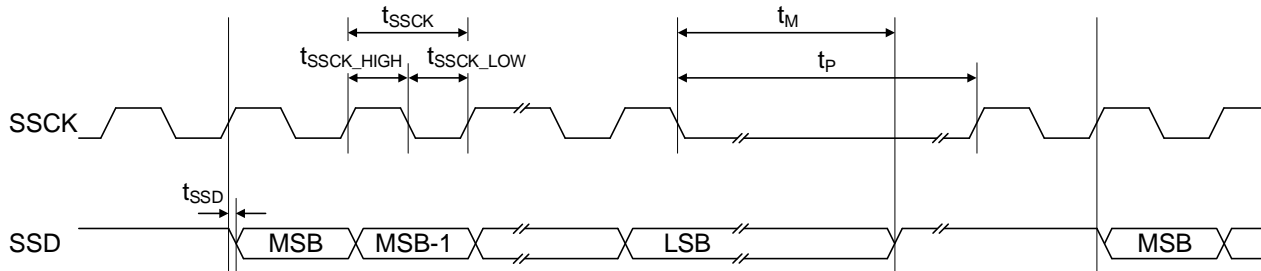

Figure 15: SSI Timing Diagram

Table 5: SSI Communication Timing

Parameter	Description	Min	Max	Unit
t _{SSD}		-	15	ns
t _{SSCK}	SSCK period	0.04	16	µs
t _{SSCK_LOW}	Low level of the SSCK signal	0.02	8	µs
t _{SSCK_HIGH}	High level of the SSCK signal	0.02	8	µs
t _M	Transfer timeout (monoflop time)	25	-	µs
t _P	Dead time (SSCK high time for next data reading)	40	-	µs

SSI Read Angle

The bit order of the transmitted data is MSB first and LSB last. New data is transferred into the output buffer every 1µs. The master device triggers the reading by driving SSCK high. A full reading requires up to 17 clock counts (see Figure 16 on page 16).

The first clock is a dummy clock that starts the transmission. The data length is up to 16 bits long. See the General Characteristics section on page 5 for the number of useful bits delivered at the serial output.

The first data MSB is transmitted on the second clock count. If the data length is less than 16 bits, then the 16-bit output word is completed by

zeros. Then the reading can also be performed with fewer than 16 clock counts. For example, for a part with a 12-bit data length, it is only necessary to send the first dummy clock to start the transmission plus 12 clocks to read the angle data.

If a trigger event is detected, then the data remains in the output buffer until the clock's falling edge for the LSB bit 0 and the transfer timeout time have elapsed (see Table 6).

Table 6: Sensor Data Timing

Trigger Event	Release of the Output Buffer
First SSCK pulse rising edge	SSCK falling edge + timeout t _M (see Figure 15)

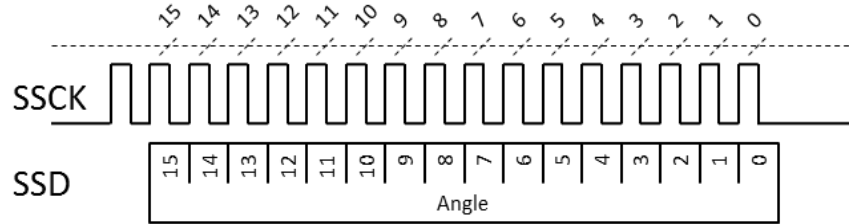

Figure 16: Full 16-Bit SSI Angle Reading (with First Dummy Clock)

Figure 17 shows consecutive angle readings in the timing diagram.

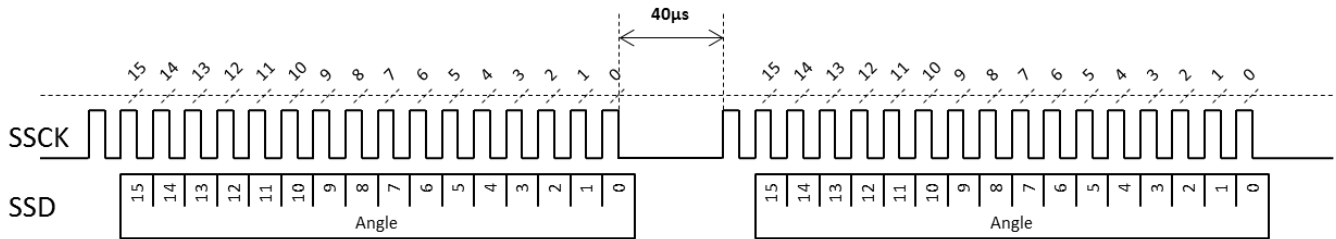

Figure 17: Two Consecutive 16-Bit SSI Angle Reading with the Required Dead Time between Frames

REGISTER MAP

Table 7: Register Map

# of Registers	Hex	Binary	Bit[7] (MSB)	Bit 6	Bit 5	Bit 4	Bit 3	Bit 2	Bit 1	Bit[0] (LSB)
0	0x0	00000	Z[7:0]							
1	0x1	00001	Z[15:8]							
2	0x2	00010	BCT[7:0]							
3	0x3	00011	-	-	-	-	-	-	ETY	ETX
4	0x4	00100	PPT[1:0]		ILIP[3:0]			-	-	
5	0x5	00101	PPT[9:2]							
6	0x6	00110	MGLT[2:0]			MGHT[2:0]			-	-
9	0x9	01001	RD	-	-	-	-	-	-	-
14	0xE	01110	FW[7:0]							
16	0x10	10000	HYS[7:0]							
27	0x1B	11011	MGH	MGL	-	-	-	-	-	-

Table 8: Factory Default Values

# of Registers	Hex	Binary	Bit 7 (MSB)	Bit 6	Bit 5	Bit 4	Bit 3	Bit 2	Bit 1	Bit 0 (LSB)
0	0x0	00000	0	0	0	0	0	0	0	0
1	0x1	00001	0	0	0	0	0	0	0	0
2	0x2	00010	0	0	0	0	0	0	0	0
3	0x3	00011	0	0	0	0	0	0	0	0
4	0x4	00100	1	1	0	0	0	0	0	0
5	0x5	00101	1	1	1	1	1	1	1	1
6	0x6	00110	0	0	0	1	1	1	0	0
9	0x9	01001	0	0	0	0	0	0	0	0
14	0xE	01110	0	1	1	1	0	1	1	1
16	0x10	10000	1	0	0	1	1	1	1	0

Table 9: Configuration Parameters

Parameters	Symbol	# of Bits	Description	See Table
Zero setting	Z	16	Sets the zero position	10
Bias current trimming	BCT	8	For side-shaft configuration, reduces the bias current of the X or Y Hall device	13
Enable trimming X	ETX	1	Biased current trimmed in the X-direction Hall device	14
Enable trimming Y	ETY	1	Biased current trimmed in the Y-direction Hall device	14
Pulses per turn	PPT	10	Number of pulses per turn of the ABZ output	18
Index length / index position	ILIP	4	Parametrization of the ABZ index pulse	Figure 26
Magnetic field high threshold	MGHT	3	Sets the field strength high threshold	16
Magnetic field low threshold	MGLT	3	Sets the field strength low threshold	16
Rotation direction	RD	1	Determines the sensor positive direction	12
Filter window	FW	8	Size of the digital filter window	17
Hysteresis	HYS	8	Hysteresis of the ABZ output	20

REGISTER SETTINGS

Zero Setting

The zero position of the MA735 (a_0) can be configured with 16 bits of resolution. The angle streamed out by the part (a_{OUT}) can be calculated with Equation (2):

$$a_{OUT} = a_{RAW} - a_0 \quad (2)$$

Where a_{RAW} is the raw angle provided by the MA735 front end.

The parameter $Z[15:0]$, which is 0 by default, is the complementary angle of the zero setting. a_0 can be written in decimals with Equation (3):

$$a_0 = 2^{16} - Z(15:0) \quad (3)$$

Table 10 shows the zero-setting parameter.

Table 10: Zero-Setting Parameter

Z[15:0]	Zero Position a_0 16-bit (dec)	Zero Position a_0 (deg)
0	65536	360
1	65535	359.995
2	65534	359.989
...
65534	2	0.011
65535	1	0.005

Example

To set the zero position to 20° , the $Z(15:0)$ parameter must equal the complementary angle. $Z(15:0)$ can be calculated with Equation (4):

$$Z(15:0) = 2^{16} - \frac{20^\circ}{360^\circ} 2^{16} = 61895 \quad (4)$$

In binary, this is written as 1111 0001 1100 0111.

Table 11 shows the content of register 0 and register 1.

Table 11: Register 0 and Register 1 Content

Reg	Bit 7	Bit 6	Bit 5	Bit 4	Bit 3	Bit 2	Bit 1	Bit 0
0	1	1	0	0	0	1	1	1
1	1	1	1	1	0	0	0	1

Rotation Direction

When looking at the top of the package, by default the angle increases as the magnetic field rotates clockwise (see Figure 18).

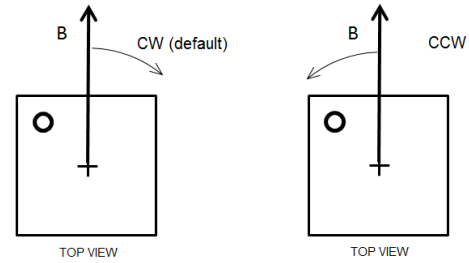

Figure 18: Positive Rotation Direction of the Magnetic Field

Table 12 shows the rotation direction parameter.

Table 12: Rotation Direction Parameter

RD	Positive Direction
0	Clockwise (CW)
1	Counterclockwise (CCW)

Bias Current Trimming (BCT) Settings

Side-Shaft

When the MA735 is mounted on the side of the magnet, the relationship between the field angle and the mechanical angle is no longer directly linear. This effect is related to the fact that the tangential magnetic field is typically smaller than the radial field. The field ratio (k) can be determined with Equation (5):

$$k = B_{RAD} / B_{TAN} \quad (5)$$

Where B_{RAD} is the maximum radial tangential magnetic field, and B_{TAN} is the maximum tangential magnetic field (see Figure 19).

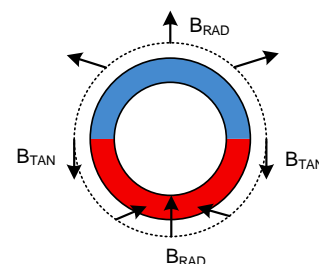

Figure 19: Side-Shaft Field

The k ratio depends on the magnet geometry and the distance to the sensor. Having a k ratio other than 1 results in the sensor output response not being linear with respect to the mechanical angle. Note that the error curve has the shape of a double sinewave (see Figure 20 on page 20).

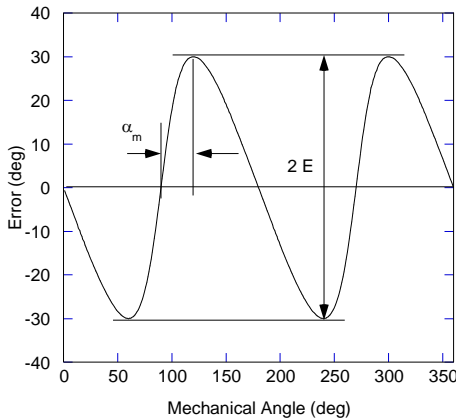

Figure 20: Error Curve in Side-Shaft Configuration (BCT = 0)

E is the amplitude of this error.

The X-axis or the Y-axis bias current can be reduced to recover an equal Hall signal for all angles to suppress the error. The ETX and ETY parameters control the direction in which sensitivity is reduced. The current reduction is set by the parameter bias current trimming (BCT[7:0]), which is an integer between 0 and 255.

In side-shaft configurations (i.e. the sensor center is located beyond the magnet outer diameter), $k > 1$. For the best compensation, the sensitivity of the radial axis should be reduced by setting the BCT parameter. BCT(7:0) can be calculated with Equation (6):

$$\text{BCT}(7:0) = 258 \left(1 - \frac{1}{k} \right) \quad (6)$$

Figure 21 shows the optimal BCT value for a particular k ratio.

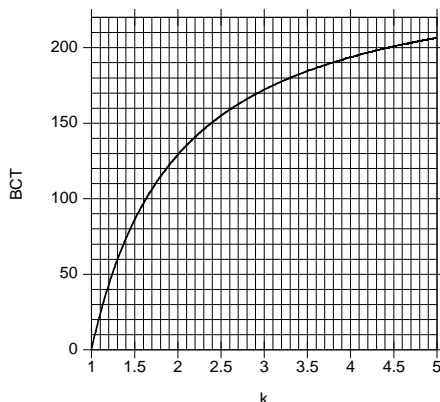

Figure 21: Relationship between the k Ratio and the Optimal BCT to Recover Linearity

Table 13 shows the BCT settings.

Table 13: BCT Settings

E (deg)	Magnet Ratio (k)	BCT[7:0]
0	1	0
11.5	1.5	86
19.5	2	129
25.4	2.5	155
30	3	172
33.7	3.5	184
36.9	4	194
39.5	4.5	201
41.8	5	207

Determining k

The k ratio can be deduced from the error curve obtained with the default BCT setting (BCT = 0). Rotate the magnet more than one revolution and record the device's output. Then plot the error curve (the output minus the real mechanical position vs. the real mechanical position) and extract the two parameters: the maximum error (E) and the position of this maximum with respect to a zero crossing a_m (see Figure 21). k can be calculated with Equation (7):

$$k = \frac{\tan(E + a_m)}{\tan(a_m)} \quad (7)$$

The k parameter can also be obtained from a graph (see Figure 22).

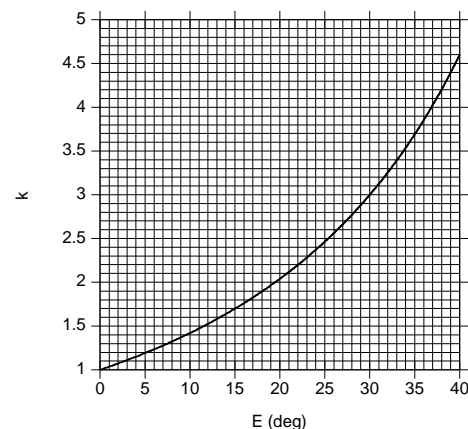

Figure 22: Relationship between the Error Measured with BCT = 0 and the Magnet Ratio k

Sensor Orientation

The dot marked on the package indicates whether the radial field is aligned with the sensor

coordinate X or Y (see Figure 23).

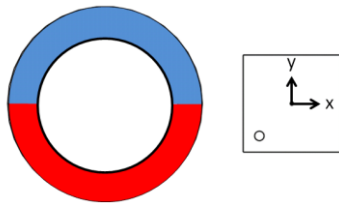

Figure 23: Package Top View with X- and Y-Axes

Determine which axis should be reduced (see Figure 19 on page 19). For example, Figure 23 shows an arrangement in which the field along the sensor Y direction is tangential and weaker. The X-axis should be reduced (ETX = 1 and ETY = 0). Note that if both ETX and ETY are set to 1, the current bias is reduced in both directions the same way (i.e. without side-shaft correction) (see Table 14 and Table 15).

Table 14: ETX Trimming Direction Parameter

ETX	Enable Trimming of the X-Axis
0	Disabled
1	Enabled

Table 15: ETY Trimming Direction Parameter

ETY	Enable Trimming of the Y-Axis
0	Disabled
1	Enabled

Magnetic Field Thresholds

The magnetic flags (MGL and MGH) indicate whether the magnetic field at the sensor position is out of the range defined by the lower and upper magnetic field thresholds (MGLT and MGHT, respectively) (see Figure 24).

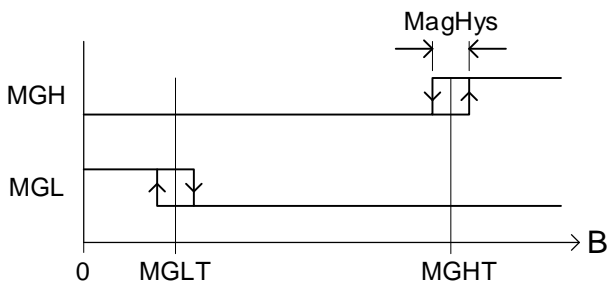

Figure 24: MGH and MGL Signals as a Function of the Field Strength

MagHys is the typical hysteresis on the signals MGH and MGL (6mT). The MGLT and MGHT

thresholds are coded on 3 bits and stored in register 6 (see Table 16).

Table 16: Register 6

Register 6							
Bit[7]	Bit[6]	Bit[5]	Bit[4]	Bit[3]	Bit[2]	Bit[1]	Bit[0]
MGLT			MGHT			-	-

The 3-bit values of MGLT and MGHT correspond to the magnetic field (see Table 17).

Table 17: MGLT and MGHT Binary to mT Relationship

MGLT or MGHT ⁽⁷⁾	Field Threshold in mT ⁽⁶⁾	
	From Low to High Magnetic Field	From High to Low Magnetic Field
000	26	20
001	41	35
010	56	50
011	70	64
100	84	78
101	98	92
110	112	106
111	126	120

Notes:

- 6) Valid for $V_{DD} = 3.3V$. If different, then the field threshold is scaled by the factor $V_{DD} / 3.3V$.
- 7) MGLT can have a larger value than MGHT.

The MGL and MGH alarm flags can be read via register 27 (bit[6] and bit[7]). The MGHT logic state is also given at digital output pin 12.

To read the MGL and MGHT flags via the SPI, send the 8-bit command write to register 27:

Command	Reg. Address	MSB	Value	LSB
0 1 0	1 1 0 1 1	0	0 0 0 0 0 0 0 0	0

The MA735 answers with the register 27 content in the next transmission:

R[7:0]							
MGH	MGL	x	x	x	x	x	x

Filter Window (FW)

The filter window (FW) affects the resolution (defined as the $\pm 3\sigma$ noise interval) and the output bandwidth, which is characterized by the cutoff frequency (f_{CUTOFF}). Table 18 on page 22 shows the resulting resolution and bandwidth for each window.

Table 18: Filter Window

FW(7:0)	τ (μ s)	Resolution at 45mT (bit)	f_{CUTOFF} (Hz)	Start-Up Time (ms)
51	64	9	6000	0.5
68	128	9.5	3000	1.1
85	256	10	1500	2.5
102	512	10.5	740	5.5
119 (default)	1024	11	370	12
136	2048	11.5	185	26
153	4096	12	93	57
170	8192	12.5	46	123
187	16384	13	23	264

The time constant (τ) is the parameter entering in the transfer function (1). This allows the user to accurately model the system, and analyze the stability of a control loop.

ABZ Incremental Encoder Output

The MA735 ABZ output emulates a 12-bit incremental encoder (such as an optical encoder) providing logic pulses in quadrature (see Figure 25).

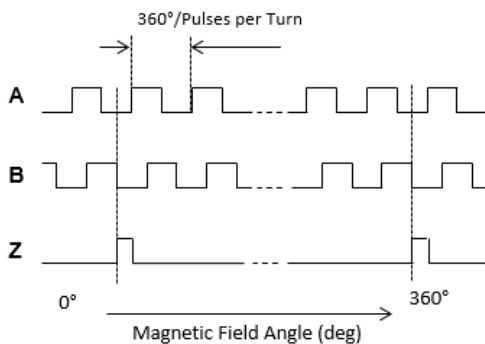
Figure 25: Timing of the ABZ Output

Compared to signal A, signal B is shifted by a quarter of the pulse period. Over one revolution, signal A pulses n times, where n can be configured between 1 and 1024 pulses per revolution. The number of pulses per channel per revolution is programmed by setting the parameter PPT, which consists of 8 bits split between registers 0x4 and 0x5 (see Table 7 on page 17). The factory default value is 1023. Table 19 shows how to configure PPT(9:0) to set the required resolution.

Table 19: PPT

PPT(9:0)	Pulses per Revolution	Edges per Revolution	
000000000	1	4	Min
000000001	2	8	
000000010	3	12	
000000011	4	16	
...
111111100	1021	4084	
111111101	1022	4088	
111111110	1023	4092	
111111111	1024	4096	Max

For example, to set 120 pulses per revolution (i.e. 480 edges), set PPT to 119 (binary: 0001110111). Table 20 shows how registers 4 and 5 should be set.

Table 20: Example PPT Setting for 120 Pulses

	B7	B6	B5	B4	B3	B2	B1	B0
R4	1	1	0	0	0	0	0	0
R5	0	0	0	1	1	1	0	1

Signal Z (zero or index) raises only once per turn, at the zero-angle position.

The position and length of the Z pulse is configurable via bits ILIP[3:0] in register 0x4 (see Figure 26).

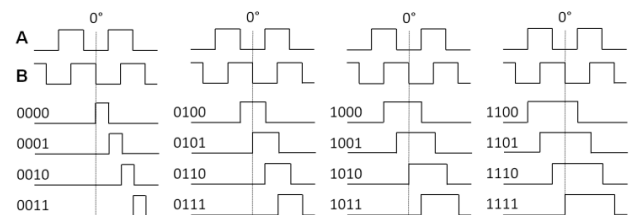
Figure 26: ILIP Parameter Effect on Index Shape

The ILIP parameter is set to 0000 by default. The index rising edge is aligned with the channel B falling edge. The index length is half of the A or B pulse edge. The index length is half the A or B pulse length.

ABZ Hysteresis

The hysteresis is set by the HYS parameter. Table 21 on page 23 shows the HYS setting and its corresponding hysteresis value in degrees.

Table 21: HYS Parameter

HYS(7:0)	Hysteresis (deg)
202	0.08
190	0.14
150	0.18
154	0.36
158 (default)	0.52
118	0.7
122	1.4
126	2.1
86	2.8

To avoid spurious transitions (see Figure 27), it is recommended that the hysteresis be 12 times larger than the output rms noise (1σ).

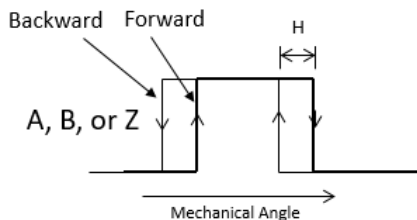

Figure 27: Hysteresis of the Incremental Output

Table 22 shows indications of the 1σ noise.

Table 22: RMS Noise

FW(7:0)	Resolution at 45mT (bit)	1σ Noise (deg)
51	9	0.12
68	9.5	0.08
85	10	0.06
102	10.5	0.04
119 (default)	11	0.03
136	11.5	0.02
153	12	0.015
170	12.5	0.01
187	13	0.007

ABZ Jitter

The ABZ state is updated at a frequency of 16MHz, enabling accurate operation up to a very high rpm (above 10^5 rpm).

The jitter characterizes how far a particular ABZ edge can occur at an angular position different from the ideal position (see Figure 28).

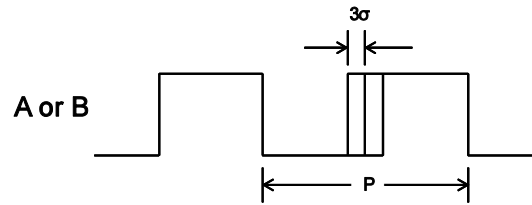
Figure 28: ABZ Jitter

The measurable jitter is composed of a systematic jitter (i.e. always the same deviation at a given angle, see the General Characteristics section) and a random jitter.

The random jitter reflects the sensor noise; therefore, the edge distribution is the same as the SPI output noise.

The random jitter is a function of the rotation speed. At a lower speed, the random jitter is smaller than the sensor noise.

This is a consequence of the fact that the probability of measuring an edge at a certain distance from the ideal position depends on the number of ABZ updates at this position.

Pulse-Width Modulation (PWM) Absolute Output

This output provides a logic signal with a duty cycle proportional to the angle of the magnetic field. See the General Characteristics section on page 5 for the pulse-width modulation (PWM) frequency (f_{PWM}). The duty cycle is bounded by a minimum value ($1/514$ of the period) and a maximum value ($513/514$ of the period), so the duty cycle varies from $1/514$ to $513/514$ with a resolution of 14 bits (see Figure 29).

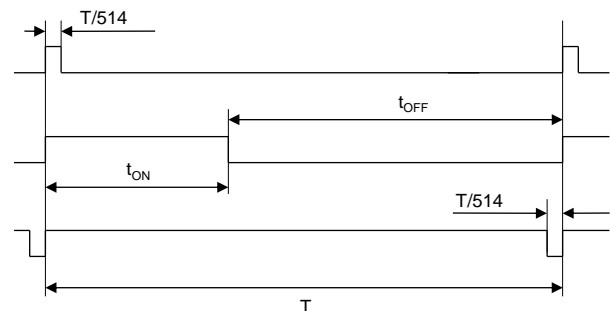

Top Signal: 0°
Bottom Signal: Full Scale (360° , $1 - 1 / 16384$)

Figure 29: PWM Output Timing

The angle can be retrieved by measuring the on time (t_{ON}). Since the absolute f_{PWM} can vary between chips, or with the temperature, an accurate angle detection requires measuring the duty cycle (i.e. the measuring both the on and off times). The angle can be calculated with Equation (8):

$$\text{angle (deg)} = \frac{360}{512} \left(514 \frac{t_{ON}}{t_{ON} + t_{OFF}} - 1 \right) \quad (8)$$

Figure 29 on page 23 shows one PWM signal period. The period (T) is $1 / f_{PWM}$.

TYPICAL APPLICATION CIRCUITS

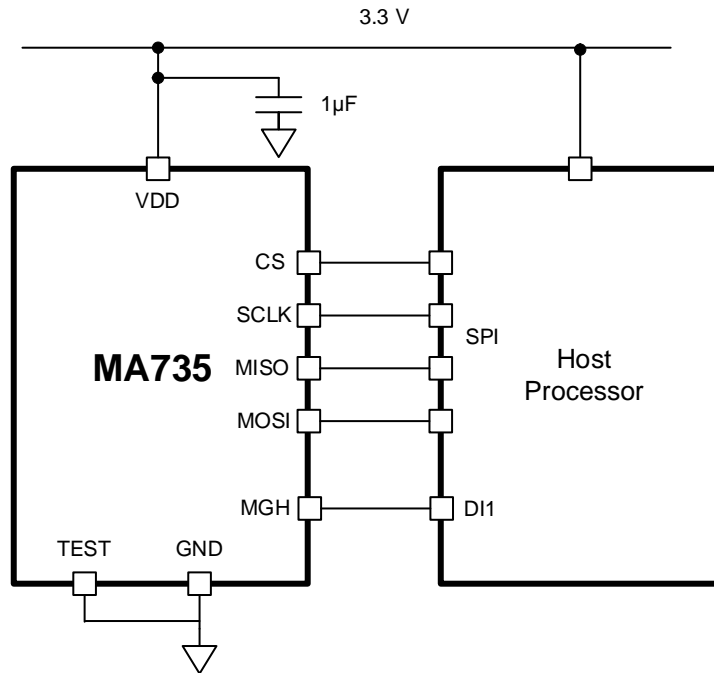

Figure 30: Typical Application Circuit Configuration using the SPI Interface and MGH Signal

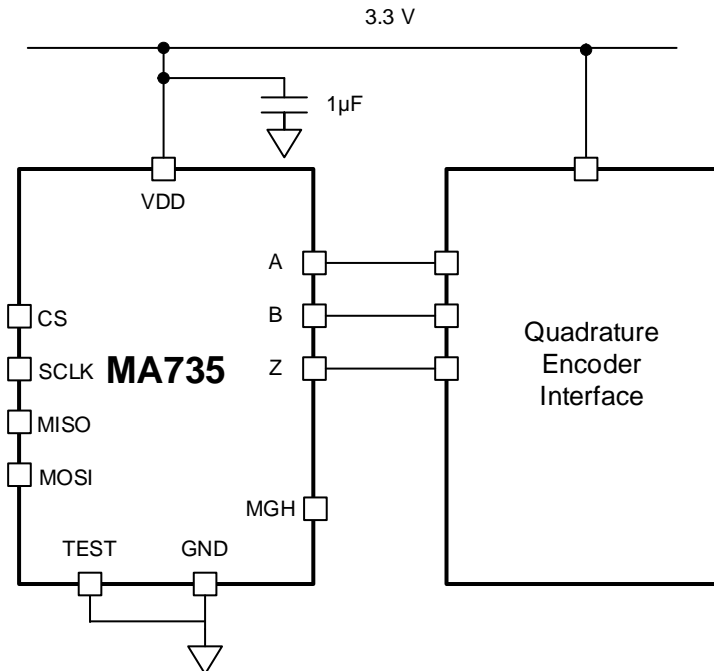

Figure 31: Typical Application Circuit Configuration Using the ABZ Interface

APPENDIX A: DEFINITIONS

Resolution (3σ noise level)	The smallest angle increment distinguishable from the noise. The resolution is measured by computing 3 x σ (the standard deviation in degrees) taken across 1,000 data points at a constant position. The resolution in bits is obtained with log ₂ (360 / 6σ).
Refresh Rate	The rate at which new data points are stored in the output buffer.
ABZ Update Rate	The rate at which a new ABZ state is computed. The inverse of this rate is the minimum time between two ABZ edges.
Latency	The time elapsed between when the data is ready to be read and when the shaft passes that position. The lag in degrees is (latency x v). Where v is the angular velocity in deg/s.
Start-Up Time	The time until the sensor delivers valid data, beginning at start-up.
Integral Nonlinearity (INL)	The maximum deviation between the average sensor output (at a fixed position) and the true mechanical angle (see Figure A1).

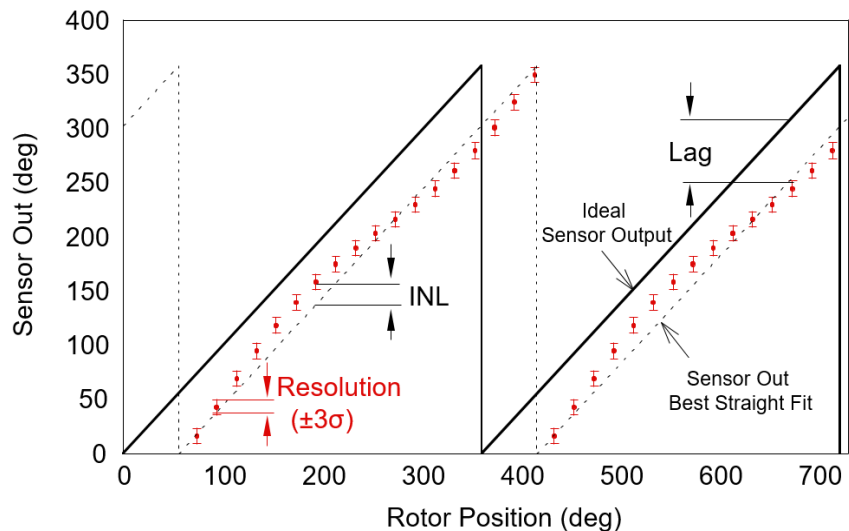

Figure A1: Resolution, INL, Lag

INL can be obtained from the error curve ($err_{(a)} = out_{(a)} - a$). Where $out_{(a)}$ is the average over 1,000 sensor output, and a is the mechanical angle indicated by a high-precision encoder ($<0.001^\circ$). Then INL can be calculated with Equation (A1):

$$INL = \frac{\max(err_{(a)}) - \min(err_{(a)})}{2} \quad (A1)$$

Drift The angle variation rate when one parameter is changed (e.g. temperature, V_{DD}) and all the others remain constant (including the shaft angle).

APPENDIX B: SPI COMMUNICATION CHEAT SHEET

Read Angle

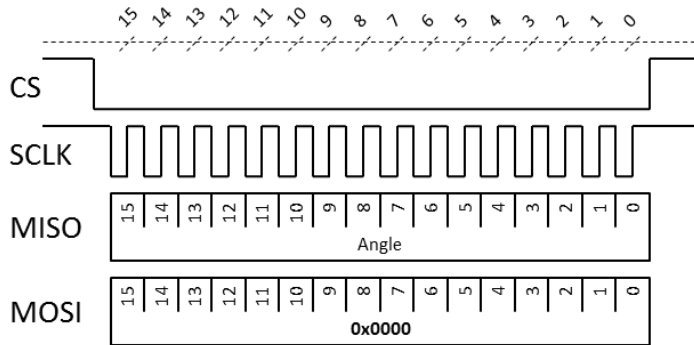

Read Register

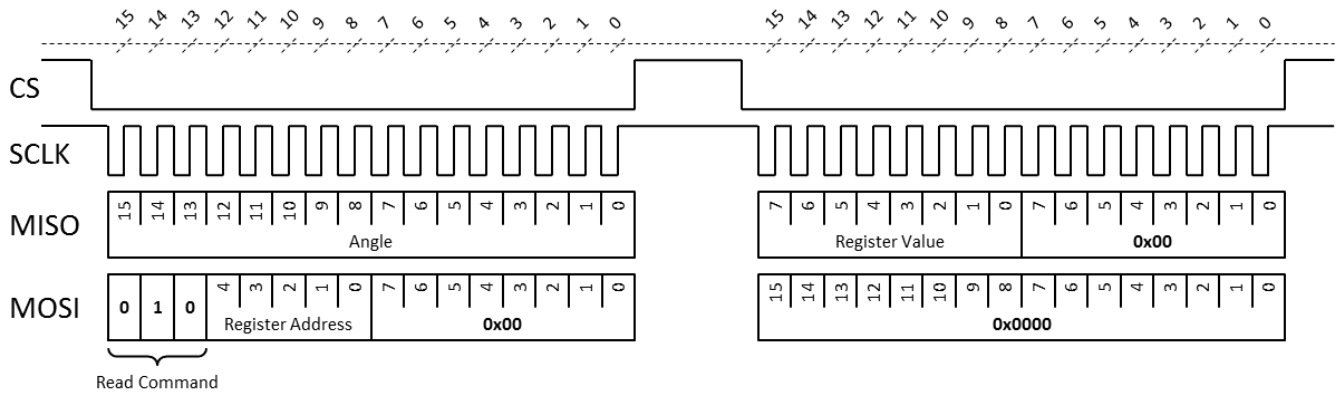

Write Register

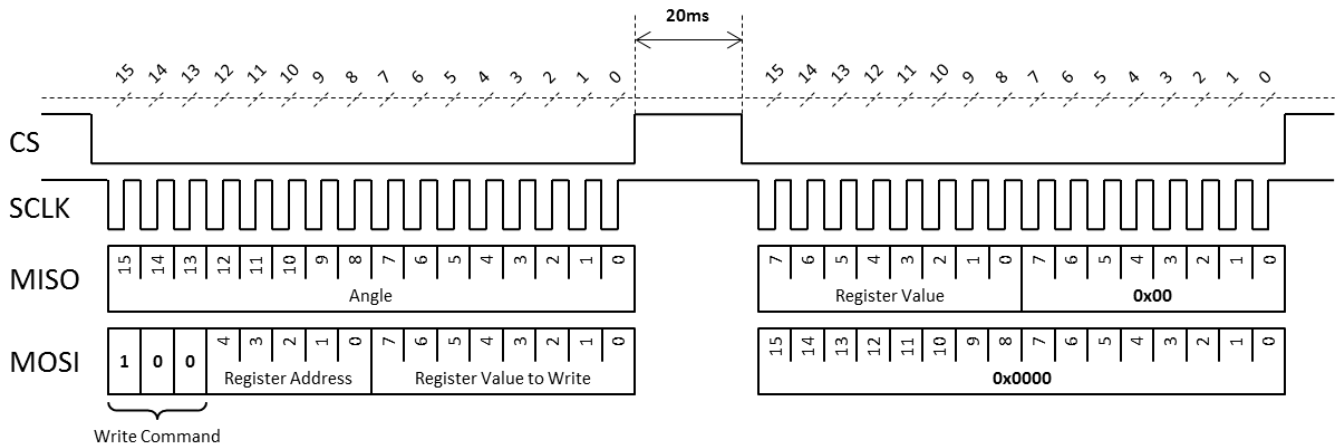

PACKAGE INFORMATION

UTQFN-14 (2mmx2mm)

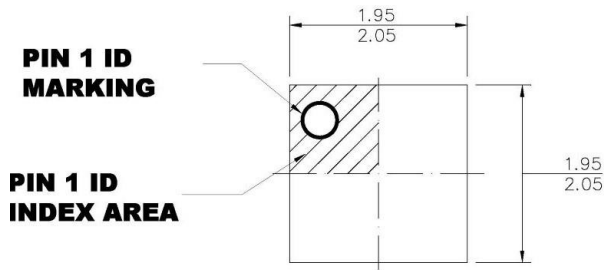

TOP VIEW

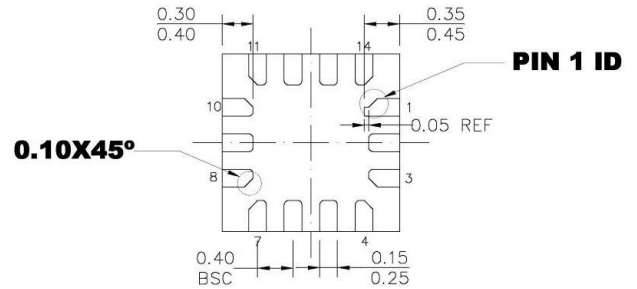

BOTTOM VIEW

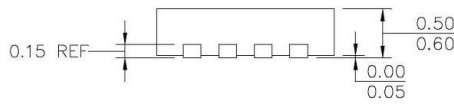

SIDE VIEW

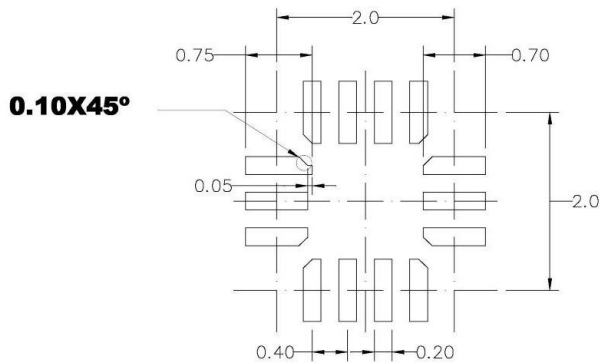

RECOMMENDED LAND PATTERN

NOTE:

- 1) ALL DIMENSIONS ARE IN MILLIMETERS.
- 2) LEAD COPLANARITY SHALL BE 0.08 MILLIMETERS MAX.
- 3) JEDEC REFERENCE IS MO-220.
- 4) DRAWING IS NOT TO SCALE.

CARRIER INFORMATION

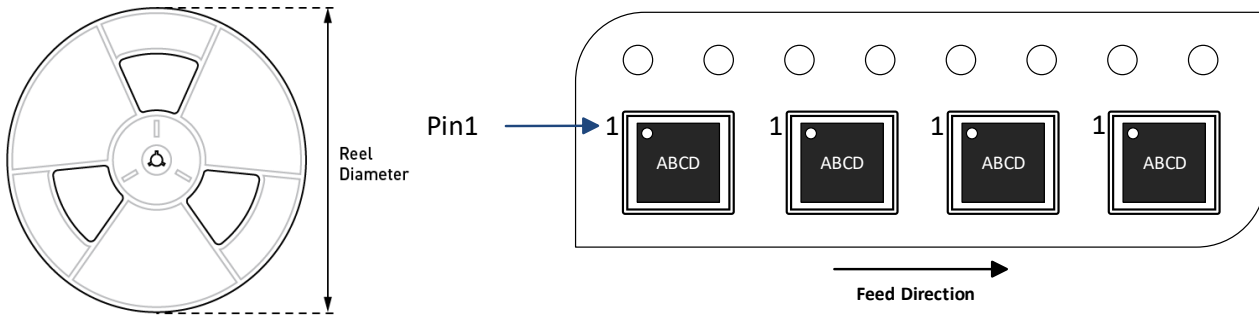

Part Number	Package Description	Quantity/ Reel	Quantity/ Tube	Quantity/ Tray	Reel Diameter	Carrier Tape Width	Carrier Tape Pitch
MA735GGU-Z	UTQFN-14 (2mmx2mm)	5000	N/A	N/A	13in	12mm	8mm



REVISION HISTORY

Revision #	Revision Date	Description	Pages Updated
1.0	4/26/2022	Initial Release	-

Notice: The information in this document is subject to change without notice. Please contact MPS for current specifications. Users should warrant and guarantee that third-party Intellectual Property rights are not infringed upon when integrating MPS products into any application. MPS will not assume any legal responsibility for any said applications.