

Features

- 3 x 2 x 1 Inches Form factor
- 75 Watts Convection
- Efficiencies upto 93%
- -40 to 70 degree operating temperature
- Thermal Shut-Down feature
- Now IEC/UL62368-1:2018 Compliant **New**
- Fulfils EN 62368-1:2014 +A11:2017
- 2.00m Hours, Telcordia-SR332-issue 3
- No Load Power < 0.3W
- Approved with metal enclosures/accessories

Electrical Specifications

Input Voltage	85-264 VAC/390 VDC ⁴ , Universal (Derate from 75W at 100V AC to 65W at 85V AC)	
Input Frequency	47-63 Hz	
Input Current	115 VAC: 1 A max.	230 VAC: 0.5 A max.
No Load Power	less than 0.3W typical	
Inrush Current	115 VAC – 25 A, 230 VAC – 45 A, 264 VAC – 75 A	
Efficiency	93%(48V,58V), 91%(24V,30V), 90%(12V,15V)	
Hold-up Time	>16 ms typical	
Power Factor	exceeds 0.95 with Full Load, Active PFC	
Output Power	75W Convection	
Output Voltage Adjustability	+/-3%	
Line Regulation	+/-0.5%	
Load Regulation	+/-1%	
Transient Response	25% step load change, at 0.1A/uS slew rate, 50% duty cycle, 50Hz=4% , recovery time < 5 ms	
Rise Time	55ms typical	
Set Point Tolerance	+/-1%	
Over Current Protection	Typ 110%	
Over Voltage Protection	110 to 140%, Latch type (AC recycling required)	
Short Circuit Protection	Hiccup mode	
Switching Frequency	60 KHz typical	
Operating Temperature ³	- 40 to +70°C, * -40 to 0°C startup is guaranteed with spec deviation	
Storage Temperature	-40 to +85°C	
Relative Humidity	5% to 95%, noncondensing	
Altitude	Operating: 16,000 ft.; Nonoperating: 40,000 ft.	
MTBF	2.00m Hours, Telcordia-SR332-issue 3	
Isolation Voltage	Input to Output – 4000 VDC for ITE application Input to GND - 2500 VDC	
Cooling	75W with natural convection cooling at 100 to 264VAC.	

Model Number	Power Supply Unit & its Installation Type	Power	Voltage	Max. Load (Convection)	Ripple ¹
LFWLP75-1X01-CK	In CK cover Kit	52.5 W	12 V	4.38 A	1%
LFWLP75-1X01	In Open Frame				
LFWLP75-1X01-L	With L Bracket	75 W	12 V	6.25 A	1%
LFWLP75-1X01-B	With Base Plate				
LFWLP75-1X01-U	With U channel				
LFWLP75-1X02-CK	In CK cover Kit	52.5 W	15 V	3.50 A	1%
LFWLP75-1X02	In Open Frame				
LFWLP75-1X02-L	With L Bracket	75 W	15 V	5.00 A	1%
LFWLP75-1X02-B	With Base Plate				
LFWLP75-1X02-U	With U channel				
LFWLP75-1X03-CK	In CK cover Kit	52.5 W	24 V	2.18 A	1%
LFWLP75-1X03	In Open Frame				
LFWLP75-1X03-L	With L Bracket	75 W	24 V	3.12 A	1%
LFWLP75-1X03-B	With Base Plate				
LFWLP75-1X03-U	With U channel				
LFWLP75-1X04-CK	In CK cover Kit	52.5 W	48 V	1.09 A	1%
LFWLP75-1X04	In Open Frame				
LFWLP75-1X04-L	With L Bracket	75 W	48 V	1.56 A	1%
LFWLP75-1X04-B	With Base Plate				
LFWLP75-1X04-U	With U channel				
LFWLP75-1X05-CK	In CK cover Kit	52.5 W	30 V	1.75 A	1%
LFWLP75-1X05	In Open Frame				
LFWLP75-1X05-L	With L Bracket	75 W	30 V	2.50 A	1%
LFWLP225-1X05-B	With Base Plate				
LFWLP225-1X05-U	With U channel				
LFWLP75-1X06-CK	In CK cover Kit	52.5 W	58 V	0.90 A	1%
LFWLP75-1X06	In Open Frame				
LFWLP75-1X06-L	With L Bracket	75 W	58 V	1.29 A	1%
LFWLP75-1X06-B	With Base Plate				
LFWLP75-1X06-U	With U channel				
For Screw Terminal version replace "X" above with "0", example LFWLP75-1005					
For Header version replace "X" above with "3", example LFWLP75-1305					
LFWLP120/75-CK metal cover kit accessory available.					

Pin Connections		
J1	Pin 1	AC LINE
	Pin 2	NOT FITTED
	Pin 3	AC NEUTRAL
J2	Pin 1,2	V1 -VE
	Pin 3,4	V1 +VE

Notes

1. Ripple is peak to peak with 20 MHz bandwidth and 10 μ F (Electrolytic capacitor) in parallel with a 0.1 μ F capacitor at rated line voltage and load ranges.
2. Specifications are for nominal input voltage, 25°C unless otherwise stated.
3. Output ripple can be more than 10% of the output voltage.
4. Functional, not approved.
5. When used in Cover Kit, de-rate output power to 70 % under all operating conditions.
6. For Class II version Enquire with EOS Sales Rep before Order.

Mechanical Specifications

AC Input Connector (J1) Option 1	Molex: 39357-0003 Tyco: 2-1776112-3	(J1) Option 2	Molex: 1722861103 (Mating conn: Molex 1722561003) (Mating conn: Molex 1722561103) (Mating conn: Molex 1722563103)
DC Output Connector (J2) Option 1	Molex: 39357-0004 Tyco: 2-1776112-4	(J2) Option 2	Molex: 1722861104 (Mating conn: Molex 1722561004) (Mating conn: Molex 1722561104) (Mating conn: Molex 1722563104)
Dimensions	3 x 2 x 1 inches (76.2 x 50.8 x 25.4 mm)		
Weight	180gm Max.		

EMC

Parameter	Conditions/Description	Criteria
Conducted Emissions	EN55032-B, CISPR22-B, FCC PART15-B	Pass
Radiated Emissions	EN 55032 A	Pass Level B with external core (King core K5B RC 25x12x15-M in input cable)
Input Current Harmonics	EN 61000-3-2	Class D
Voltage Fluctuation and Flicker	EN 61000-3-3	Pass
ESD Immunity	EN 61000-4-2	Level 3, Criterion A
Radiated Field Immunity	EN 61000-4-3	Level 3, Criterion A
Electrical Fast Transient Immunity	EN 61000-4-4	Level 3, Criterion A
Surge Immunity	EN 61000-4-5	Level 3, Criterion A
Conducted Immunity	EN 61000-4-6	Level 3, Criterion A
Magnetic Field Immunity	EN 61000-4-8	Level 3, Criterion A
Voltage dips, interruptions	EN 61000-4-11	Criterion A & B

Safety

CE Mark	Complies with LVD Directive
Approval Agency	Nemko, UL, C-UL
Safety Standard(s)	IEC 62368-1:2018, EN 62368-1:2014;A11, UL 62368-1 and CAN/CSA C22.2 No. 62368-1:19,
Safety File Number(s)	Class-I : UL: Certificate Number 20200713-E515384, Nemko: Certificate No. P20224328, CB Certificate No.: N0110826

Environmental

RoHS Version	LFWLP75 series meet RoHS compliance as per european RoHS directive (Directive 2011 / 65 / EU)
--------------	--

Derating Curve

Power de-rating in Open Frame/with L Bracket/ Base Plate/with U channel

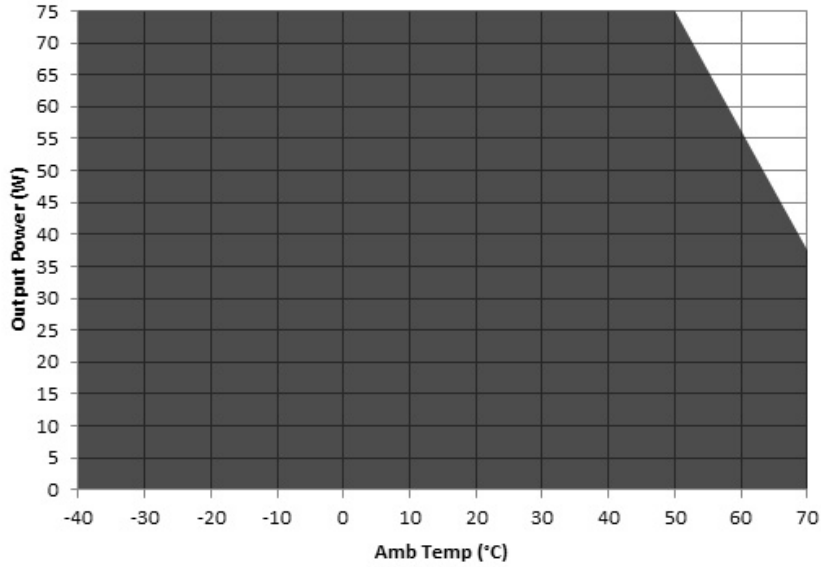

■ Convection

Convection load: 75W up to 50°C
De-rate above 50 °C @ 2.5% per °C

Power de-rating in CK cover kit

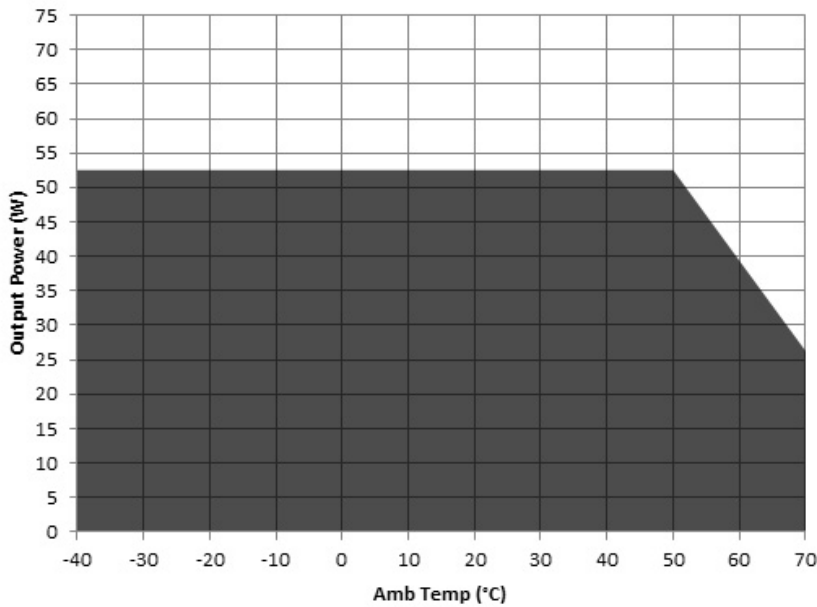

■ Convection

Convection load: 52.5W up to 50 °C
De-rate above 50 °C @ 2.5% per °C

Option -1

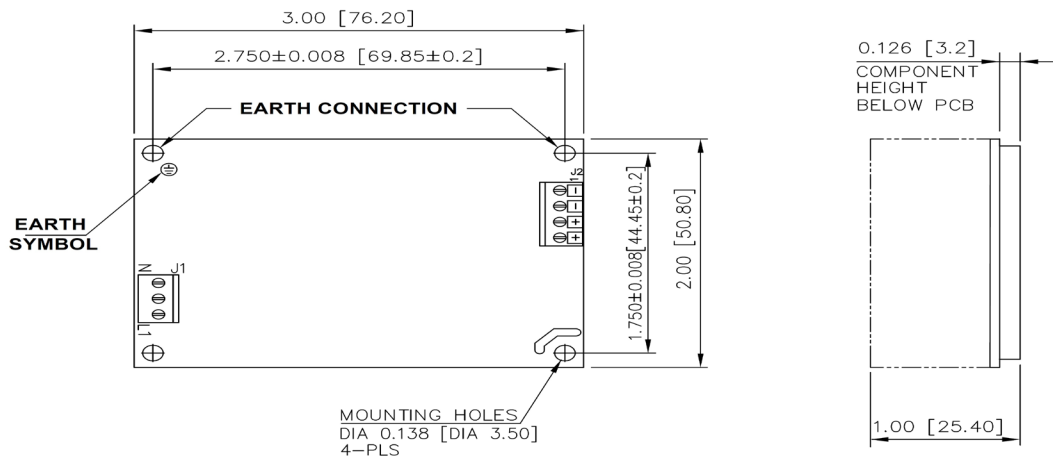

MECHANICAL OUTLINE DIMENSIONS
ALL DIMENSIONS ARE IN INCHES[MM]
GEN TOLERANCE: ± 0.06

- Notes: In case the PCB is mounted in a metal enclosure, using metal hardware ensure the following
1. Stand off, used to mount PCB has OD of 5.4 mm max.
 2. Screws, used to fix PCB on stand off, have head dia of 6.0 mm max.
 3. Washer, if used, to have dia of 6.5 mm max.

Option -2

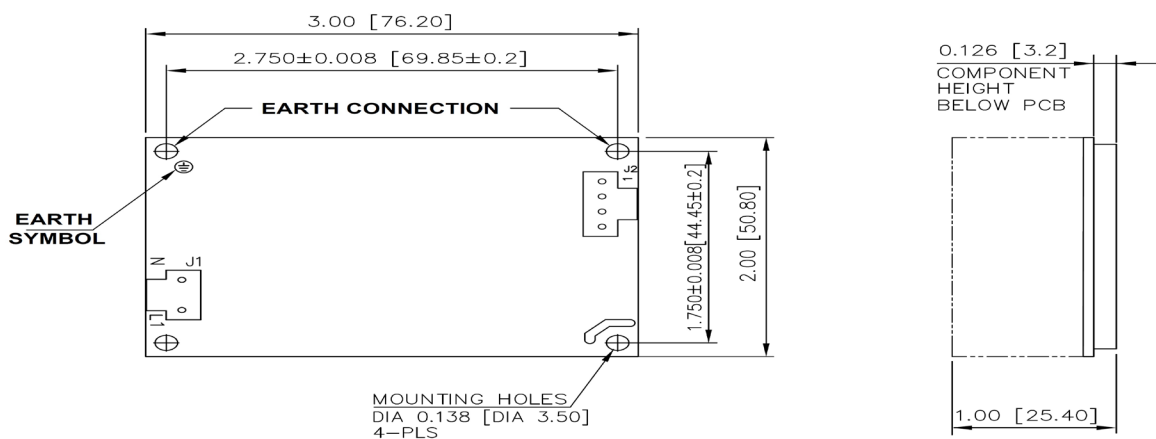

MECHANICAL OUTLINE DIMENSIONS
ALL DIMENSIONS ARE IN INCHES[MM]
GEN TOLERANCE: ± 0.06

- Notes: In case the PCB is mounted in a metal enclosure, using metal hardware ensure the following
1. Stand off, used to mount PCB has OD of 5.4 mm max.
 2. Screws, used to fix PCB on stand off, have head dia of 6.0 mm max.
 3. Washer, if used, to have dia of 6.5 mm max.

WLP75 WITH BASE PLATE

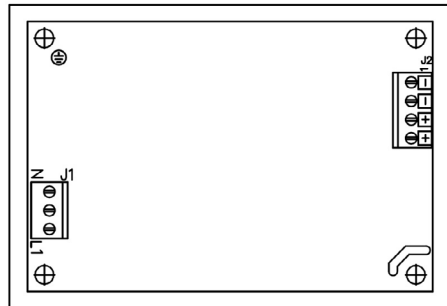

OPTION-1

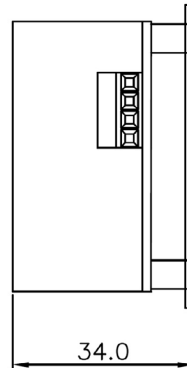

OPTION-2

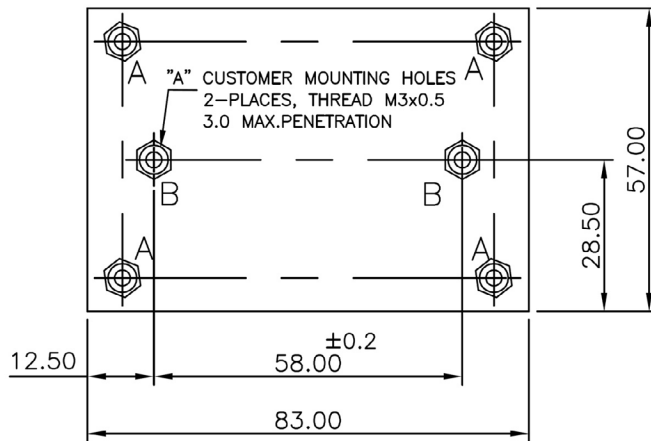
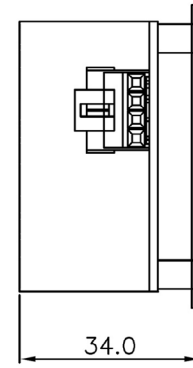

MECHANICAL OUTLINE DIMENSIONS
ALL DIMENSIONS ARE IN MM
GEN.TOLERANCE: +/-0.5 MM

Notes: In case the PCB is mounted on a metal base plate, using metal hardware ensure the following

1. Stand off, used to mount PCB has OD of 5.4 mm max.
2. Screws, used to fix PCB on stand off, have head dia of 6.0 mm max.
3. Washer, if used, to have dia of 6.5 mm max.

WLP75 SERIES WITH 'L' BRACKET

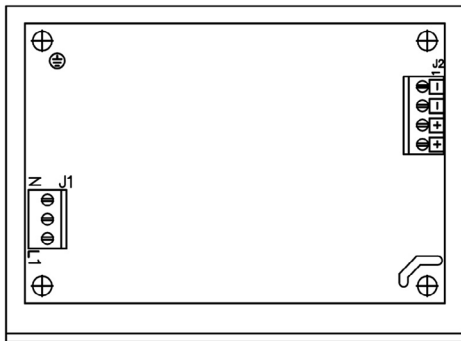

OPTION-1

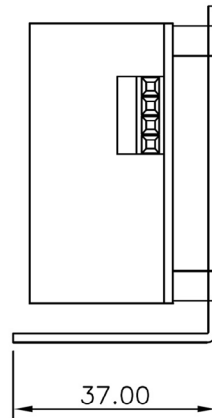

OPTION-2

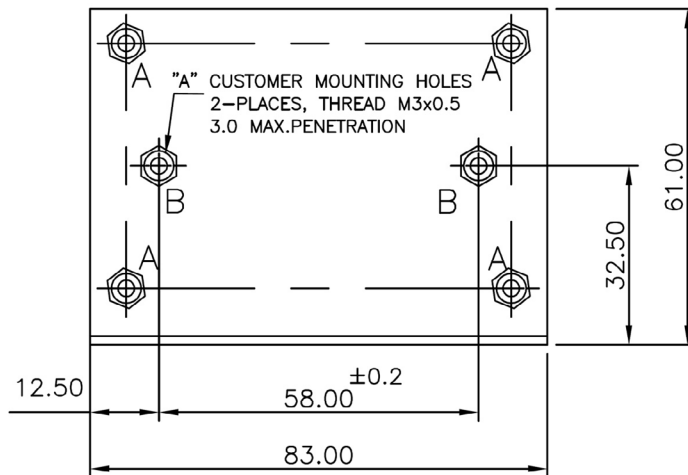
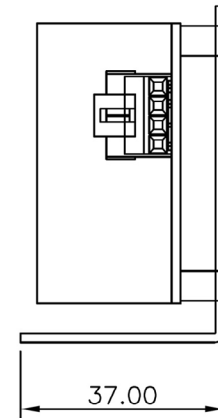

MECHANICAL OUTLINE DIMENSIONS
ALL DIMENSIONS ARE IN MM
GEN.TOLERANCE: +/-0.5 MM

Notes: In case the PCB is mounted on a metal 'L' bracket, using metal hardware ensure the following

1. Stand off, used to mount PCB has OD of 5.4 mm max.
2. Screws, used to fix PCB on stand off, have head dia of 6.0 mm max.
3. Washer, if used, to have dia of 6.5 mm max.

WLP75 SERIES WITH 'U' CHANNEL

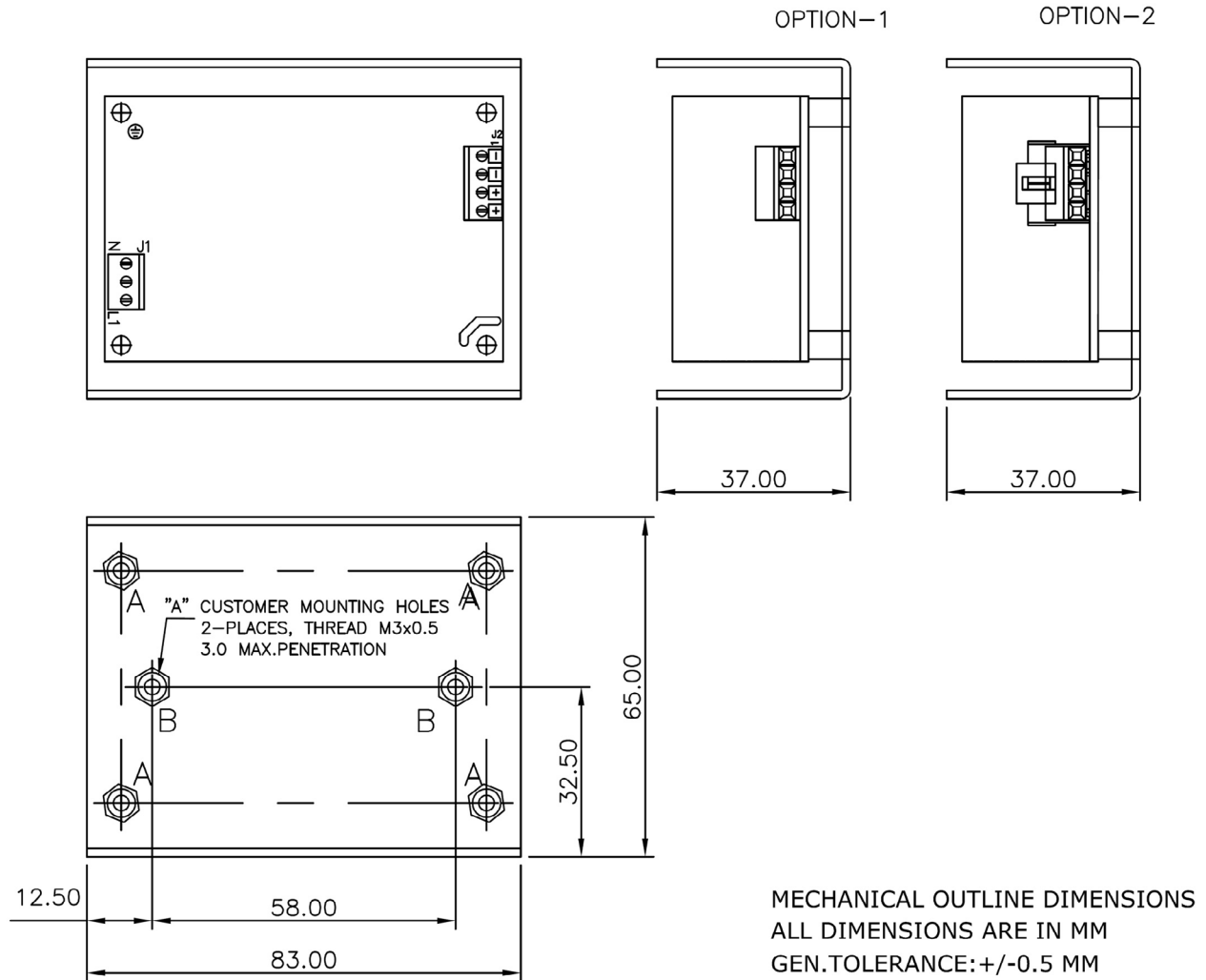

Notes: In case the PCB is mounted in a metal 'U' channel, using metal hardware ensure the following

1. Stand off, used to mount PCB has OD of 5.4 mm max.
2. Screws, used to fix PCB on stand off, have head dia of 6.0 mm max.
3. Washer, if used, to have dia of 6.5 mm max.

WLP75 SERIES WITH COVER KIT

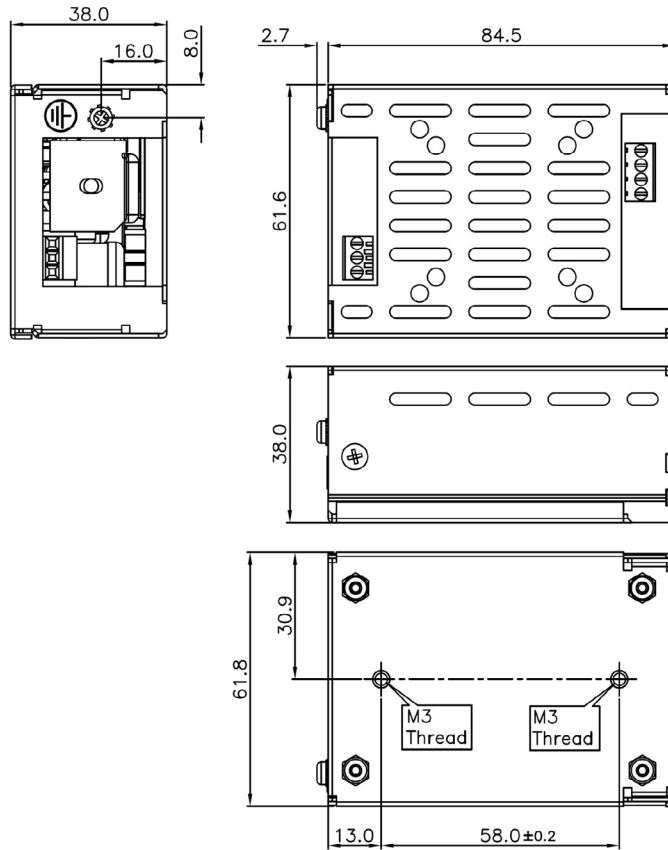

MECHANICAL OUTLINE DIMENSIONS
 ALL DIMENSIONS ARE IN MM
 GEN TOLERANCE: ± 1.0 MM
 MATERIAL: CRCA/GI 1.0MM THICK
 (POWDER COATING/ PASSIVATION/
 ED COATING BLACK)

Notes: In case the PCB is mounted in a metal cover kit, using metal hardware ensure the following

1. Stand off, used to mount PCB has OD of 5.4 mm max.
2. Screws, used to fix PCB on stand off, have head dia of 6.0 mm max.
3. Washer, if used, to have dia of 6.5 mm max.