

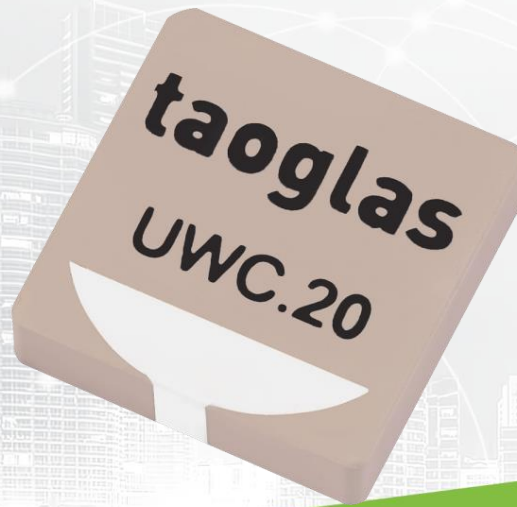

TAOGLAS®



Datasheet

3-5GHz & 6-9GHz Ultra-Wide Band (UWB) SMD Chip Antenna

Part No:
UWC.20

Description:

3-5GHz & 6-9GHz Ultra-Wide Band (UWB) SMD Chip Antenna

Features:

SMD UWB Chip Antenna
For European and USA UWB Applications
In Channels 1-10

Use Cases:

- Automotive sensors
- Smart airbags
- Precision surveying
- Smart home and entertainment systems
- Position Location and Tracking applications

Frequency: 3-5GHz & 6-9GHz

Dimensions: 12*12*3mm

RoHS & REACH Compliant

1. Introduction	3
2. Specifications	5
3. Antenna Characteristics	6
4. Radiation Patterns	11
5. Mechanical Drawing	14
6. Antenna Integration Guide	15
7. Solder Reflow Profile	21
8. Packaging	22
9. Application Note	24
<hr/>	
Changelog	31

Taoglas makes no warranties based on the accuracy or completeness of the contents of this document and reserves the right to make changes to specifications and product descriptions at any time without notice. Taoglas reserves all rights to this document and the information contained herein. Reproduction, use or disclosure to third parties without express permission is strictly prohibited.



1. Introduction



Ultra-Wideband (also known as UWB) is a low power digital wireless technology for transmitting large amounts of digital data over a wide spectrum of frequency bands typically spanning more than 500MHz with very low power for short distances.

The low power requirements of UWB mean increased battery life of sensors and tags leading to reduction in overall operational costs. Taoglas has developed various innovative and new-to-market flexible embedded UWB antennas designed for seamless integration on plastics and using highly flexible micro-coaxial cable mounting while achieving high performance where space is limited. Taoglas UWB antennas have been designed for use with the recently launched Decawave ScenSor DW1000 module and are also compatible with any other UWB sensor modules on the market.

The UWC.20 chip antenna, at 12*12*3 mm, is a small form factor Ultra-Wideband (UWB) antenna with high efficiencies across the pulsed UWB communications operational bands. It is mounted to a PCB via standard SMT reflow process. It enables designers to use only one antenna that covers all common UWB commercial bands, namely bands, 1 through 10 simultaneously.

The UWC.20 antenna is a durable ceramic antenna that has a peak gain of 4dBi, an efficiency of more than 60% across the bands and is designed to be mounted directly onto a PCB. It is an ideal choice for any device maker that needs to keep manufacturing costs down over the lifetime of a product. Like all such antennas, care should be taken to mount the antenna at least 3mm from metal components or surfaces, and ideally 5mm for best Radiation efficiency. Minimum recommended ground plane size is 31 mm x 25 mm, and antenna to ground clearance for optimum performance is 2.4 mm (please see Section 5.2).

1.1 Applications of Pulsed UWB antenna Technology

Radar-These short-pulsed antennas provide very fine range resolution and precision distance and positioning measurement capabilities. UWB signals enable inexpensive high definition radar antennas which find use in automotive sensors, smart airbags, and precision surveying applications amongst many others.

Home Network Connectivity- Smart home and entertainment systems can take advantage of high data rates for streaming high quality audio and video contents in real time for consumer electronics and computing within a home environment.

Position location & Tracking- UWB antennas also find use in Position Location and Tracking applications such as locating patients in case of critical condition, hikers injured in remote areas, tracking cars, and managing a variety of goods in a big shopping mall. UWB offers better noise immunity and better accuracy to within a few cm compared to current localization technologies such as Assisted GPS for Indoors, Wi-Fi and cellular which are at best able to offer meter level precision. Tethered Indoor positioning UWB systems that measure the angles of arrival of ultra-wideband (UWB) radio signals perform triangulation by using multiple sensors to communicate with a tag device.

2. Specifications

Electrical			
Standard	USA UWB channels 1-4	EU UWB/ USA UWB channels 5-8	USA UWB channels 9-10
Operation Frequency (GHz)	3.1–5.0	6.2–8.0	8.0–9.0
Return Loss (dB)	-10	-10	-6
Efficiency (%)	80	70	70
Peak Gain (dBi)	6	3.5	2.5
Max VSWR	2:1	2:1	3:1
Radiation Properties	Omnidirectional		
Polarization	Linear		
Impedance (Ohms)	50		
Max input Power (Watts)	10		
Mechanical			
Dimensions	12*12*3mm		
Material	Ceramic		
Environmental			
Operation Temperature	-40°C to 105°C		
Storage Temperature	-40°C to 105°C		
Humidity	40% to 90%		
Moisture Sensitivity Level (MSL)	3 (168 Hours)		

* Note: Results obtained for antenna on Standard Evaluation Board size 45 mm x 25 mm, with 31 mm x 25 mm ground plane.

3. Antenna Characteristics

3.1 Return Loss

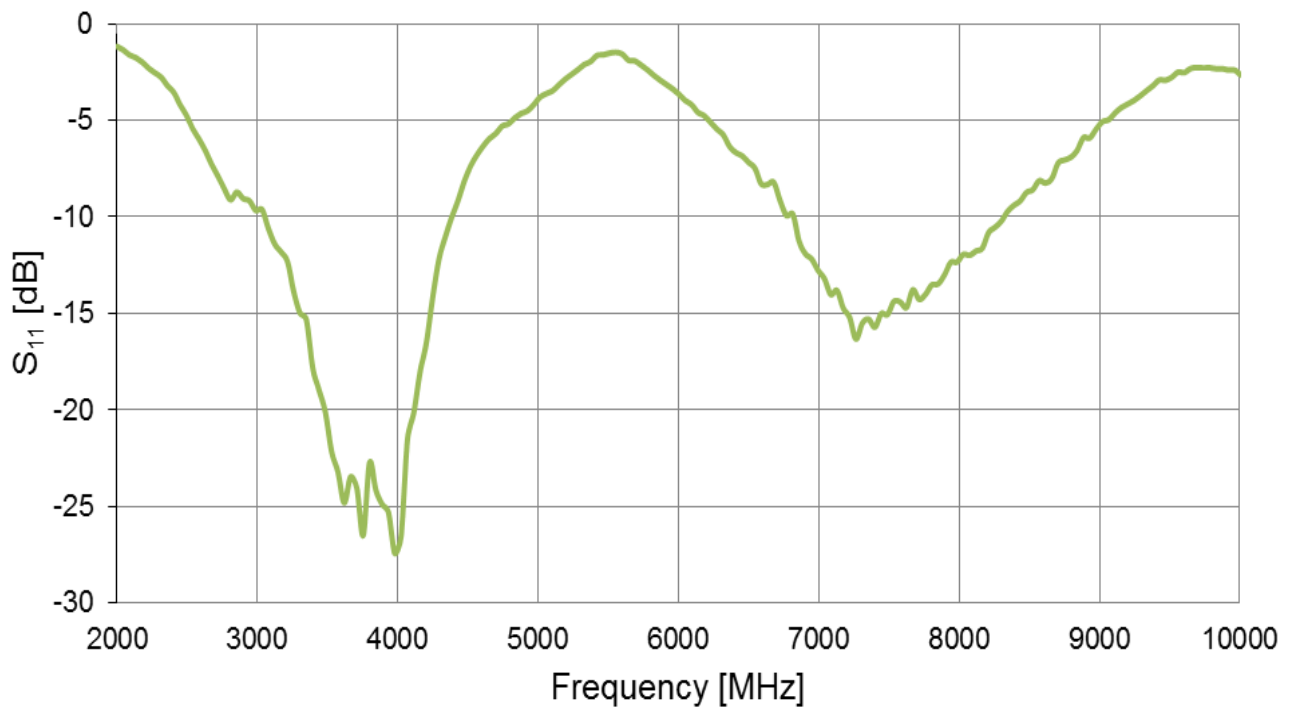

3.2 VSWR

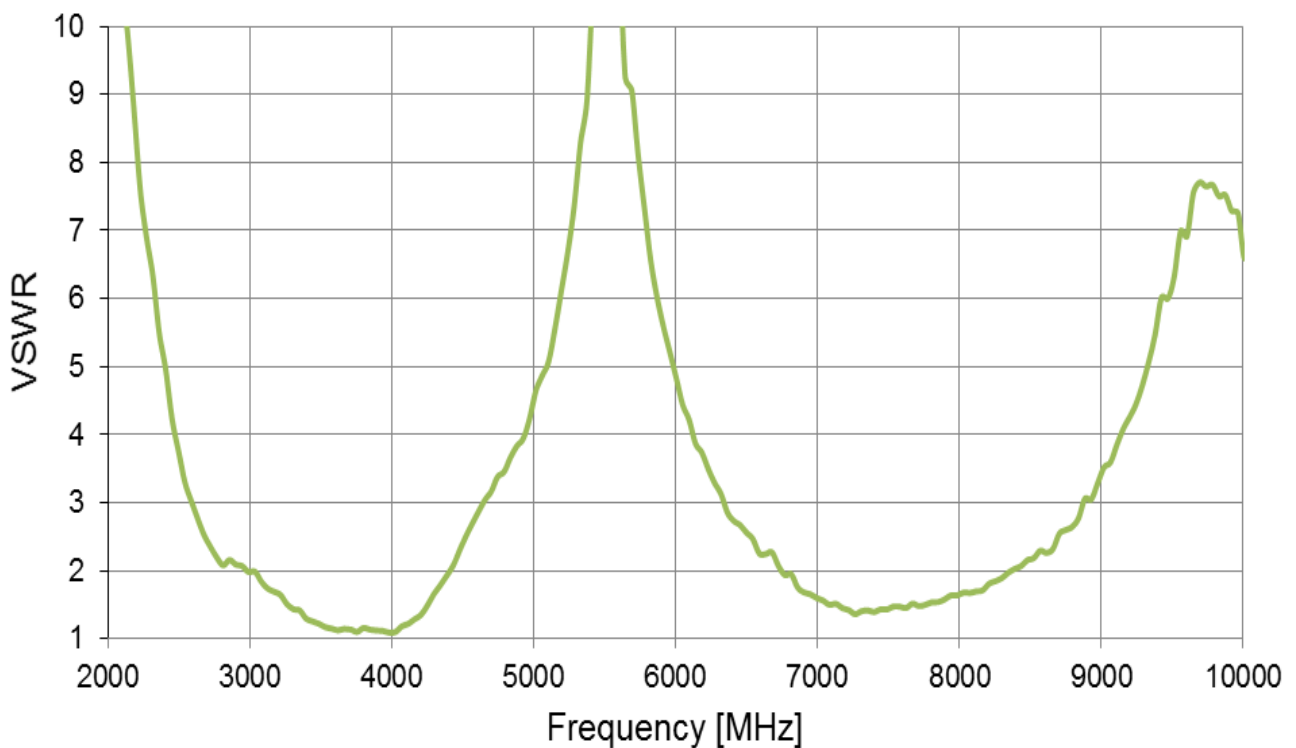

3.3 Peak Gain

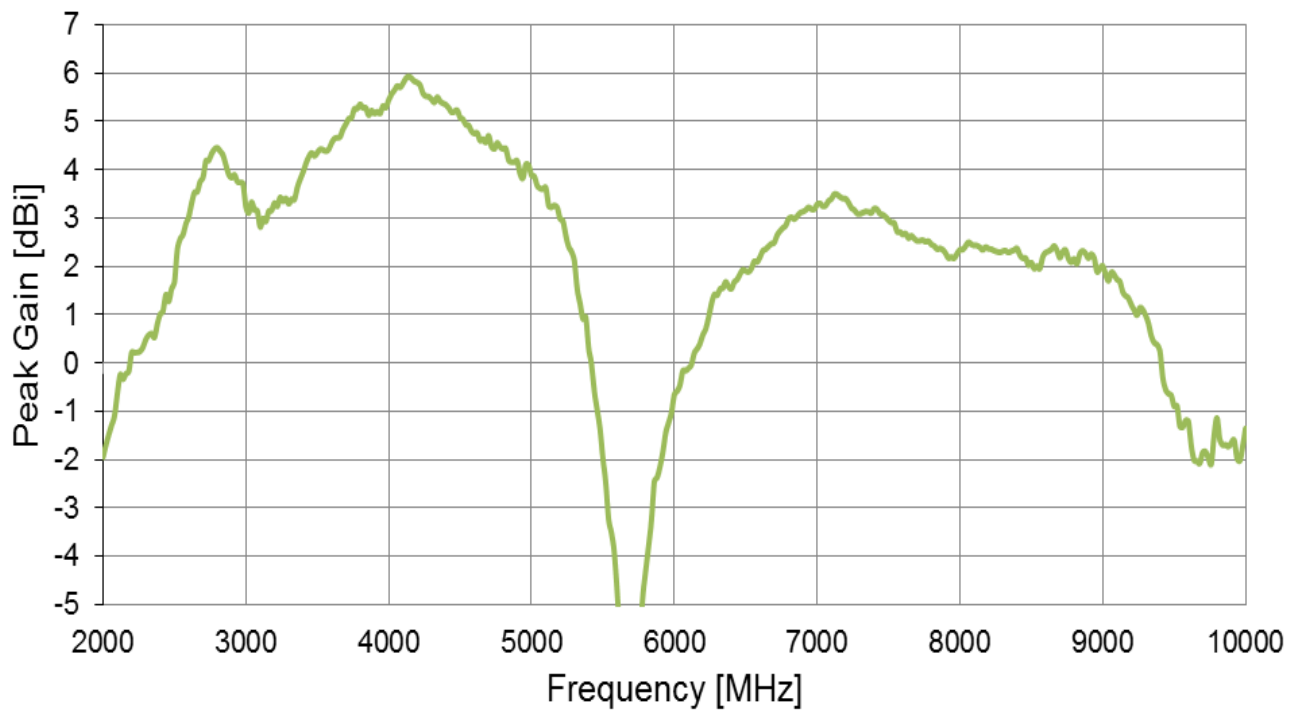

3.4 Average Gain

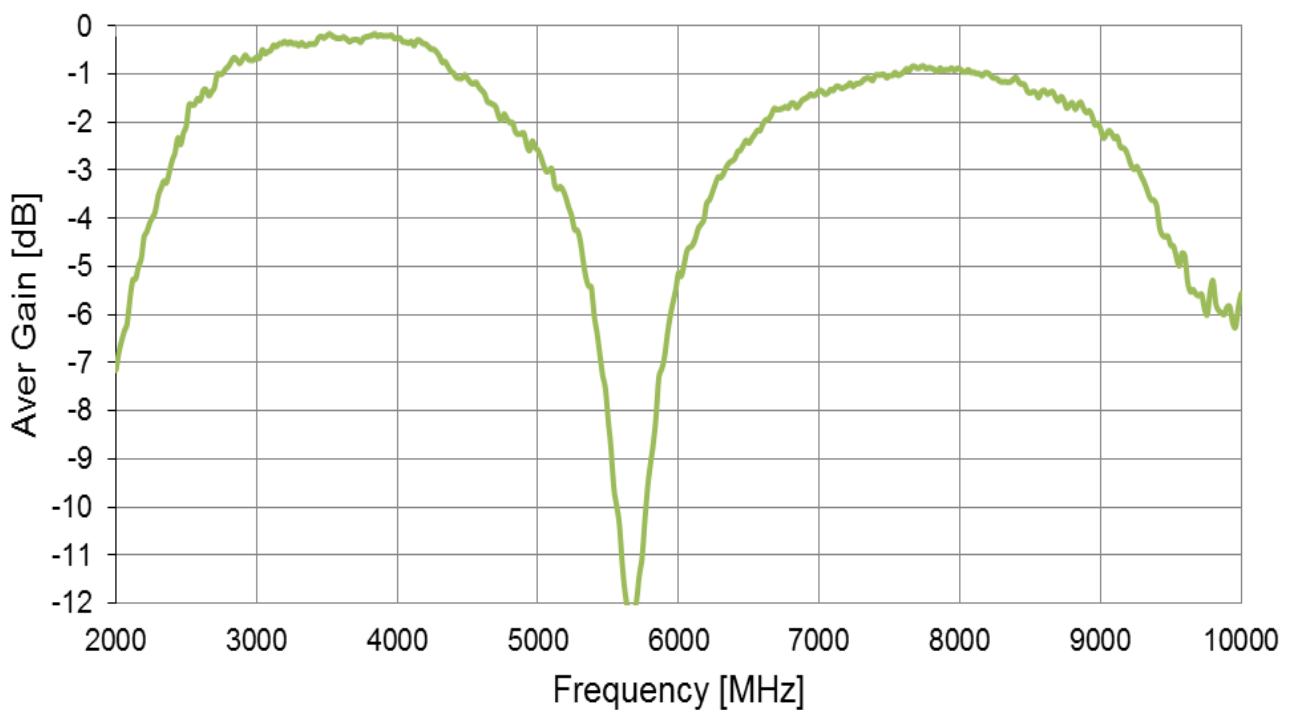

3.5 Efficiency

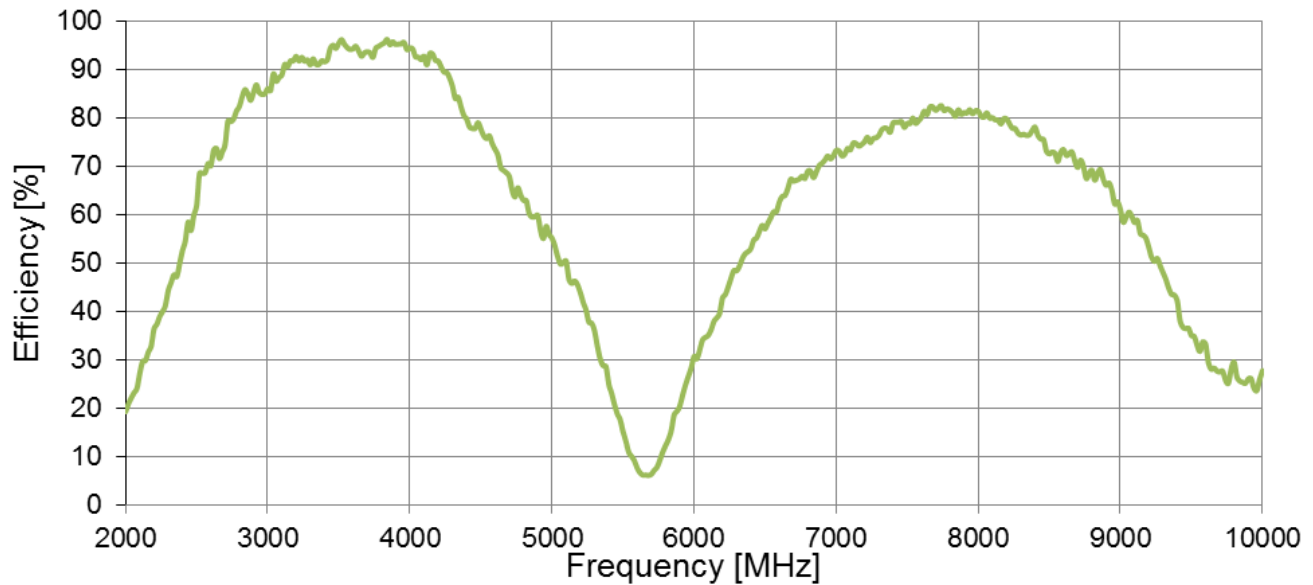

3.6 Group Delay (XY Plane) at 6.5GHz

The Total System Group Delay (in seconds) is the total time delay or transmit time of the amplitude envelopes of the various sinusoidal components of UWB signals through a device or link budget system. Effectively it is the propagation delay in transmitting antenna (Tx), propagation channel (Ch), and in receiving antenna (Rx) summed together.

An even more important parameter is the Group Delay Variation over Theta Angle from an average constant group delay. The group delay ripple is used to quantify this deviation. Ultimately, deviations from a maximally flat or constant group delay represent distortions in the output signal which is undesirable. A group delay variation of 100-150ps or less is considered acceptable for UWB system implementation.

3.7 Group Delay Vs Frequency

The group delay was simulated for two UWC.20 antennas placed at a far-field distance of 0.3m. One of the antennas was kept stationary, while the other was rotated in 45° intervals.

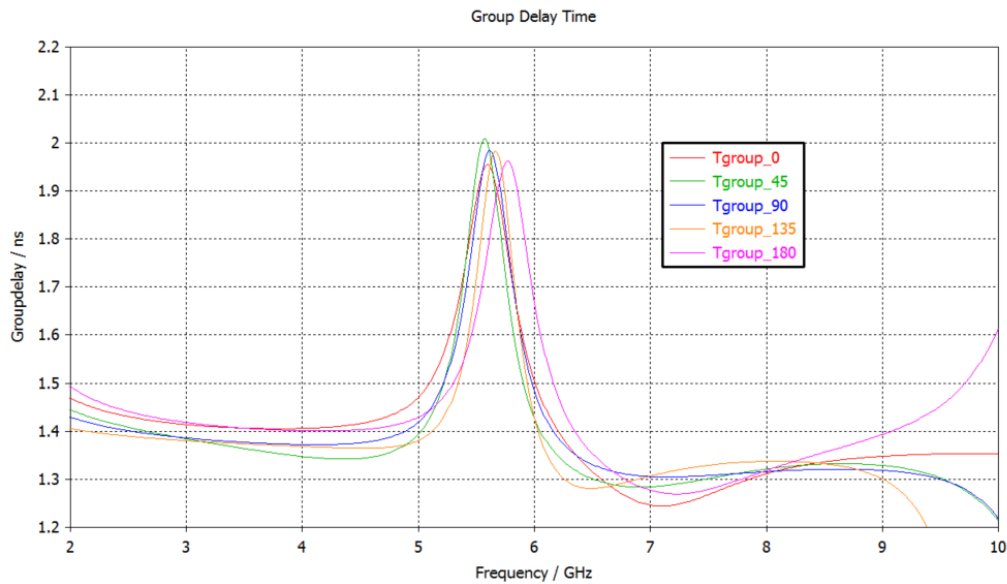

3.8 Max Group Delay Over Theta

The calculated Maximum difference between the highest value and the lowest Group Delay value (in the above graph) is presented below. The UWC.20 antenna presents Group Delay variation smaller than 100 ps (benchmark) from 3GHz to 5GHz and from 6.4GHz to 9GHz spanning UWB channels 1-4 and 6-15. For channel 5 (6-7GHz) the Group Delay variation is between 220 ps (at edge) and 50 ps, which is still considered acceptable.

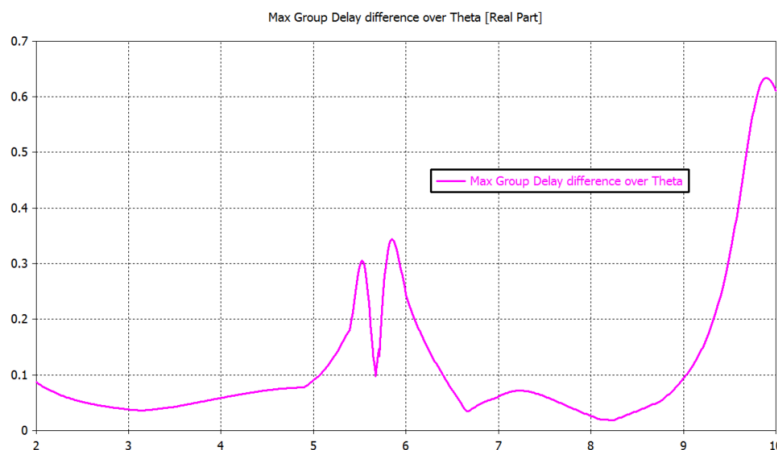

3.9 Fidelity Factor vs. Theta Angle

The fidelity is above 0.9 (benchmark value) for all Theta angles, therefore UWC.20 shows very good performance.

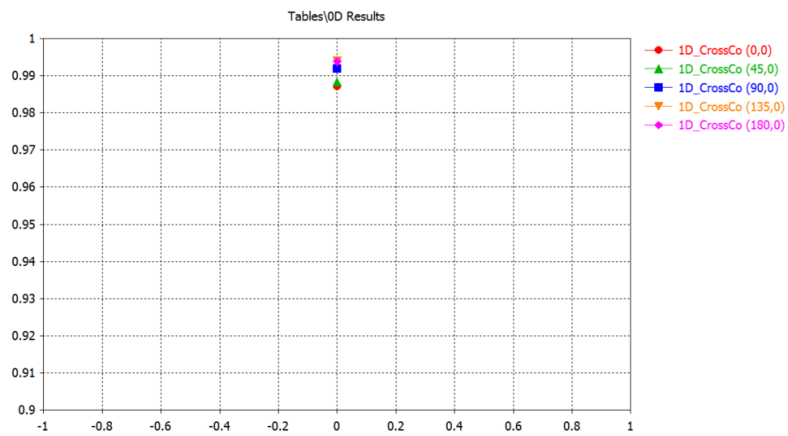

Fidelity Factor for 3-5GHz

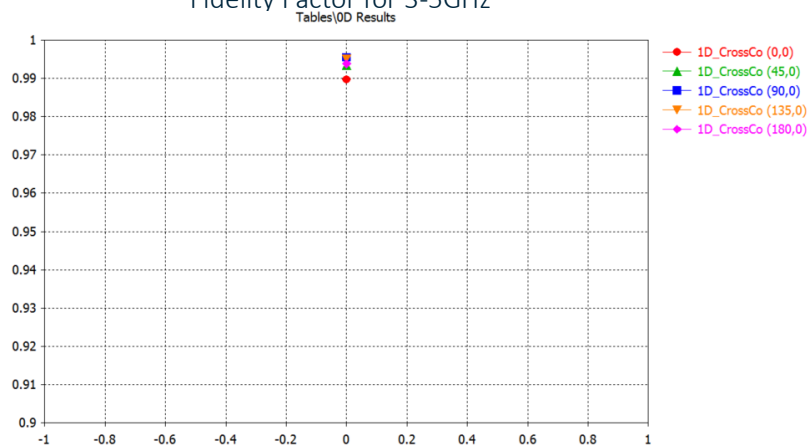

Fidelity Factor for 6-9GHz

4. Radiation Patterns

4.1 Test Setup

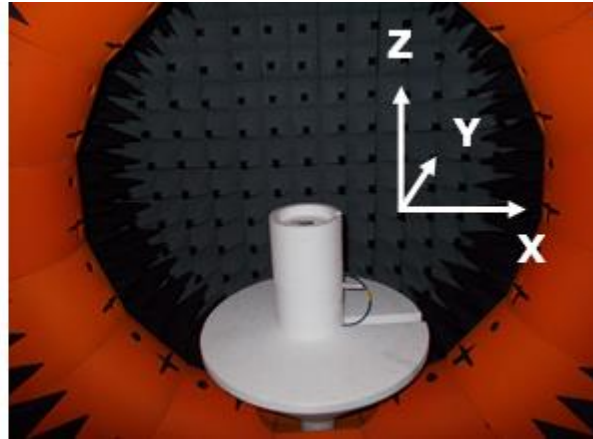
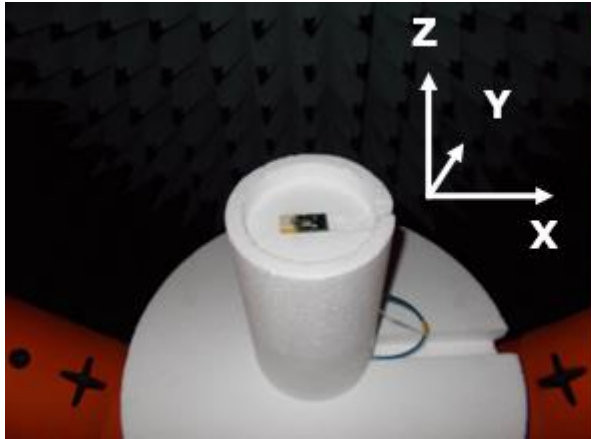

4.2 3D and 2D Radiation Patterns

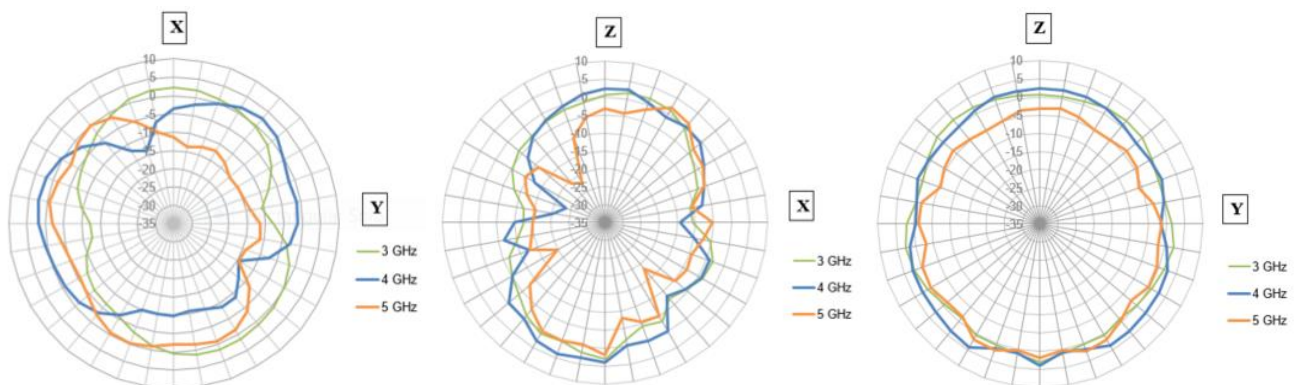
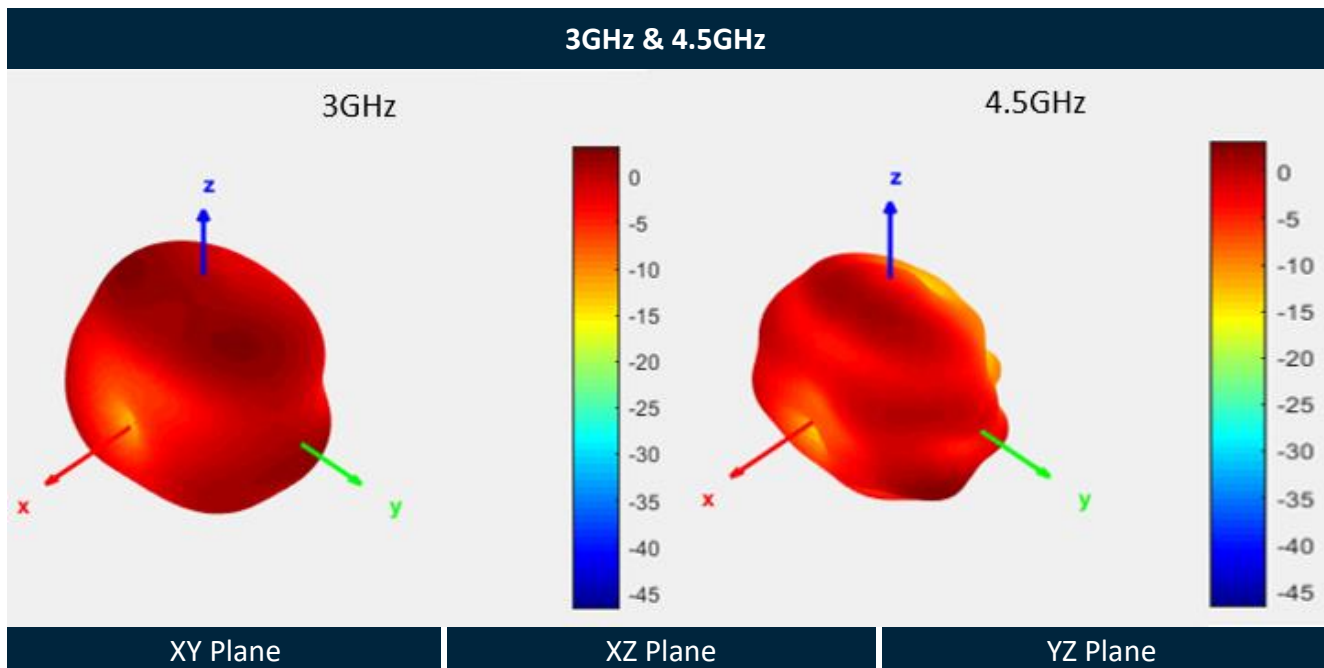

6.5GHz & 8GHz

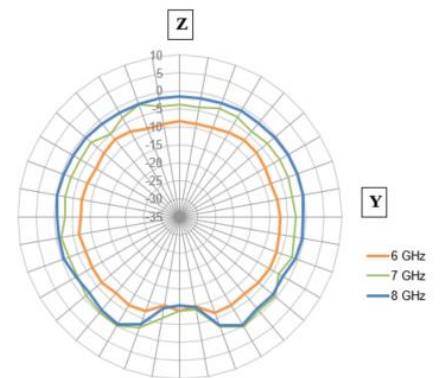
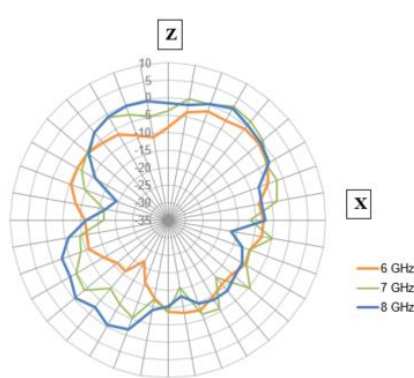
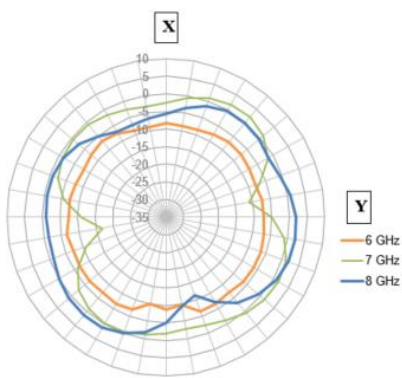
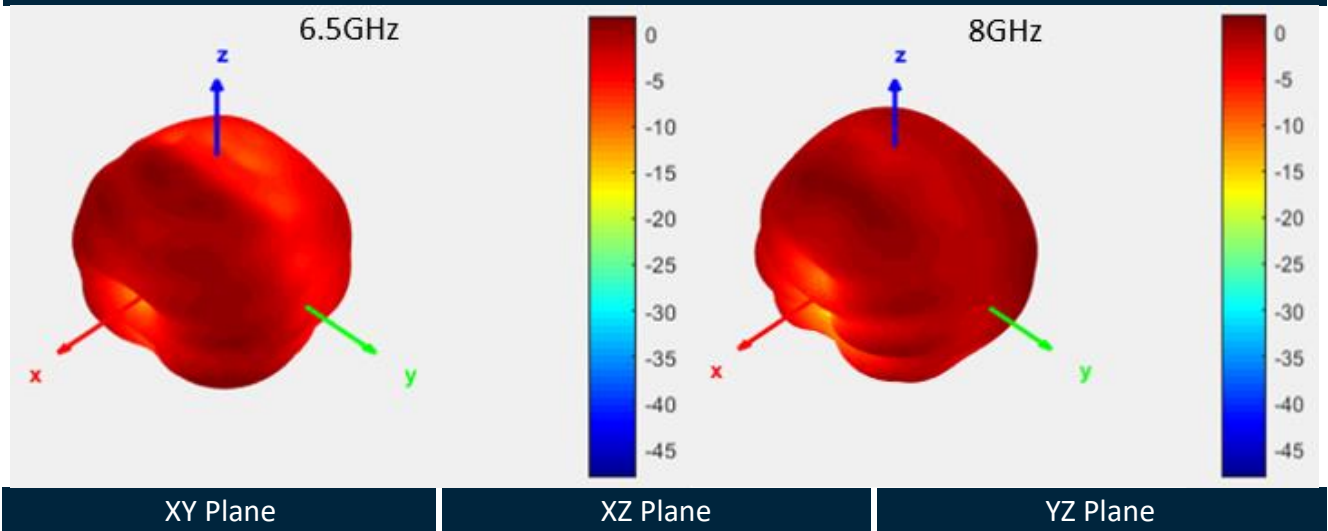

5. Mechanical Drawing (Units: mm)

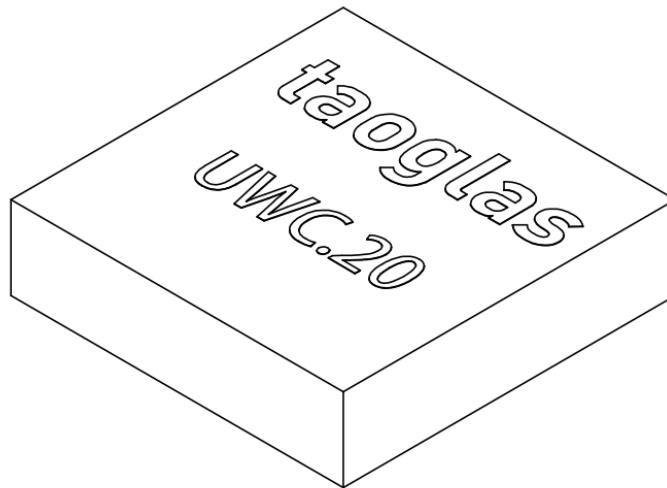

ISOMETRIC VIEW

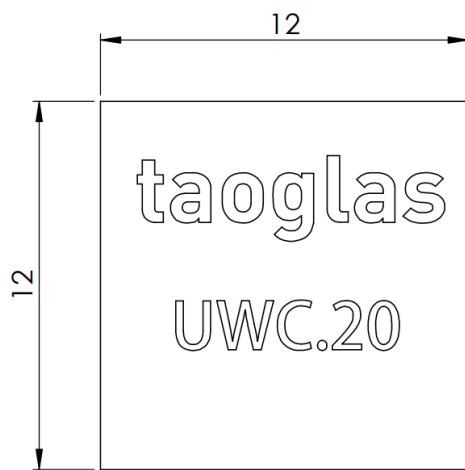

TOP VIEW



SIDE VIEW

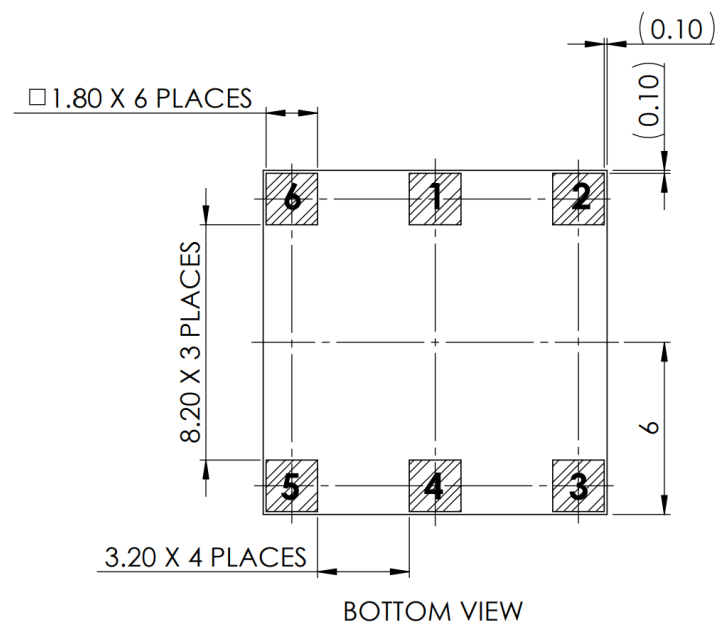

BOTTOM VIEW

6. Antenna Integration Guide

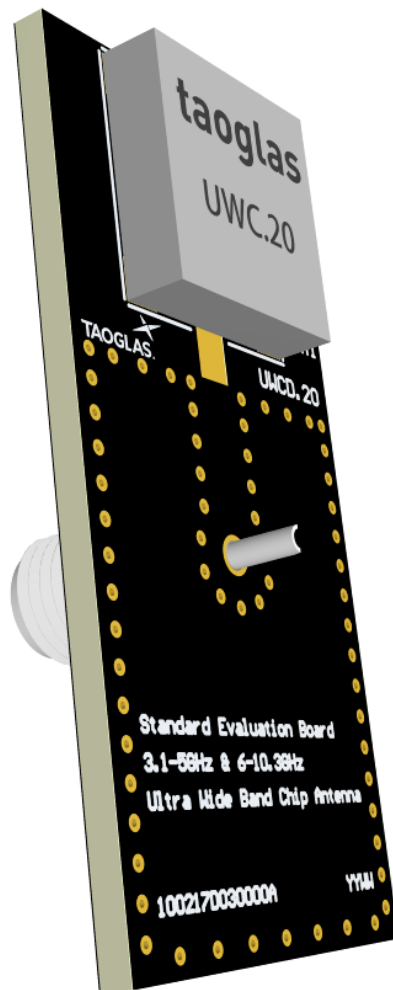

6.1 Schematic Symbol and Pin Definition

The circuit symbol for the antenna is shown below. The antenna has 6 pins with only one pin (Pin 1) as functional. Pins 2, 3, 4, 5 and 6 are for mechanical strength.

Pin	Description
1	RF Feed
2, 3, 4, 5, 6	Mechanical, Not Connected

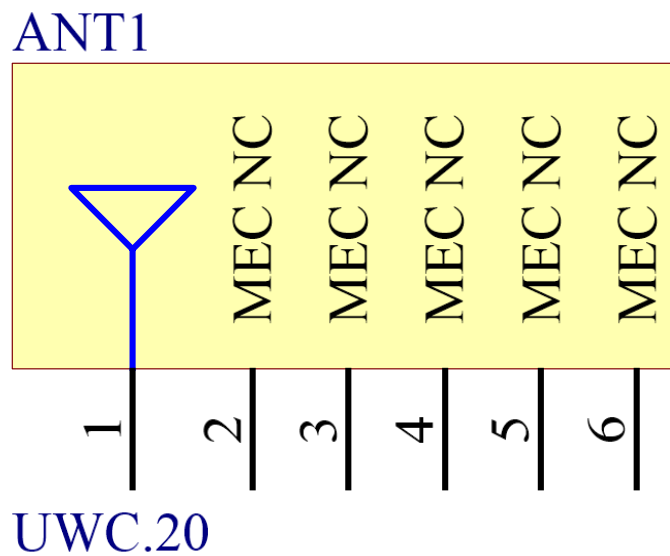

Please note you can download the design files, 3D model, 2D drawings and CST simulation files from the website here:

<https://www.taoglas.com/product/uwc-20-3-5ghz-6-9ghz-ultra-wideband-uw-b-smd-chip-antenna/>

6.2 Antenna Integration

Whatever the size of the PCB, the antenna should ideally be placed on the PCB's shortest side, to take advantage of the ground plane. Optimized matching components can be placed as shown.

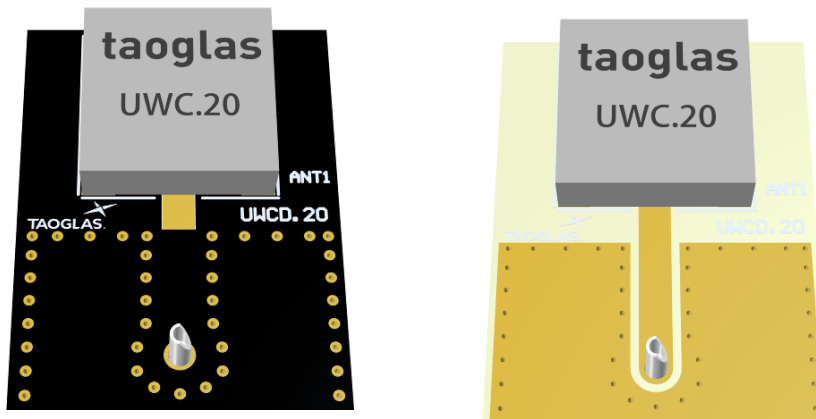

6.3 PCB Layout

The footprint and clearance on the PCB must meet the antenna specification. An example of the PCB layout shows the antenna footprint with clearance. If matching components are used with this antenna they should be placed inside the ground plane.

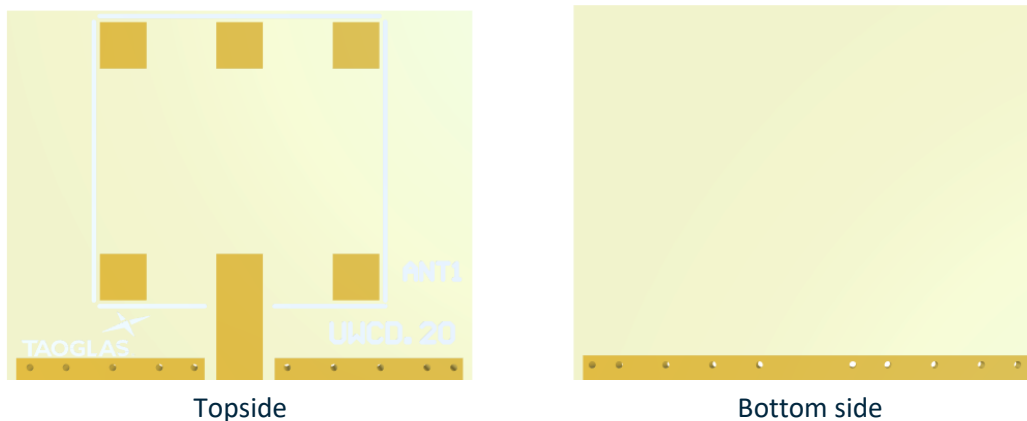

6.4 PCB Clearance

Below shows the antenna footprint and clearance through all layers on the PCB. Only the antenna pads and connections to feed and GND are present within this clearance area (marked RED). The clearance area extends to 2.4mm from the antenna mechanical pads to the ground area. This clearance area includes the bottom side and ALL internal layers on the PCB.

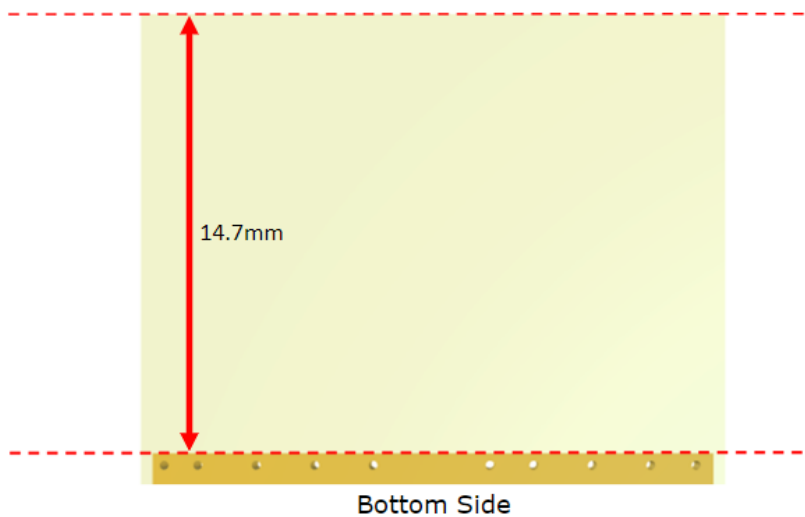
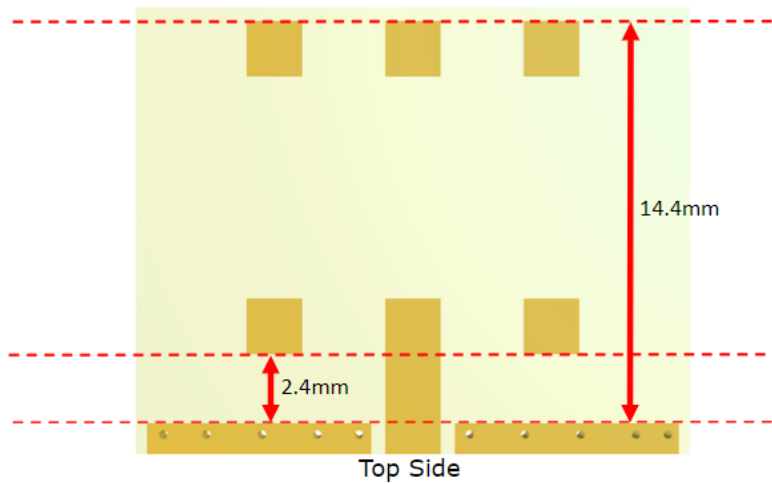

6.5 Evaluation Board

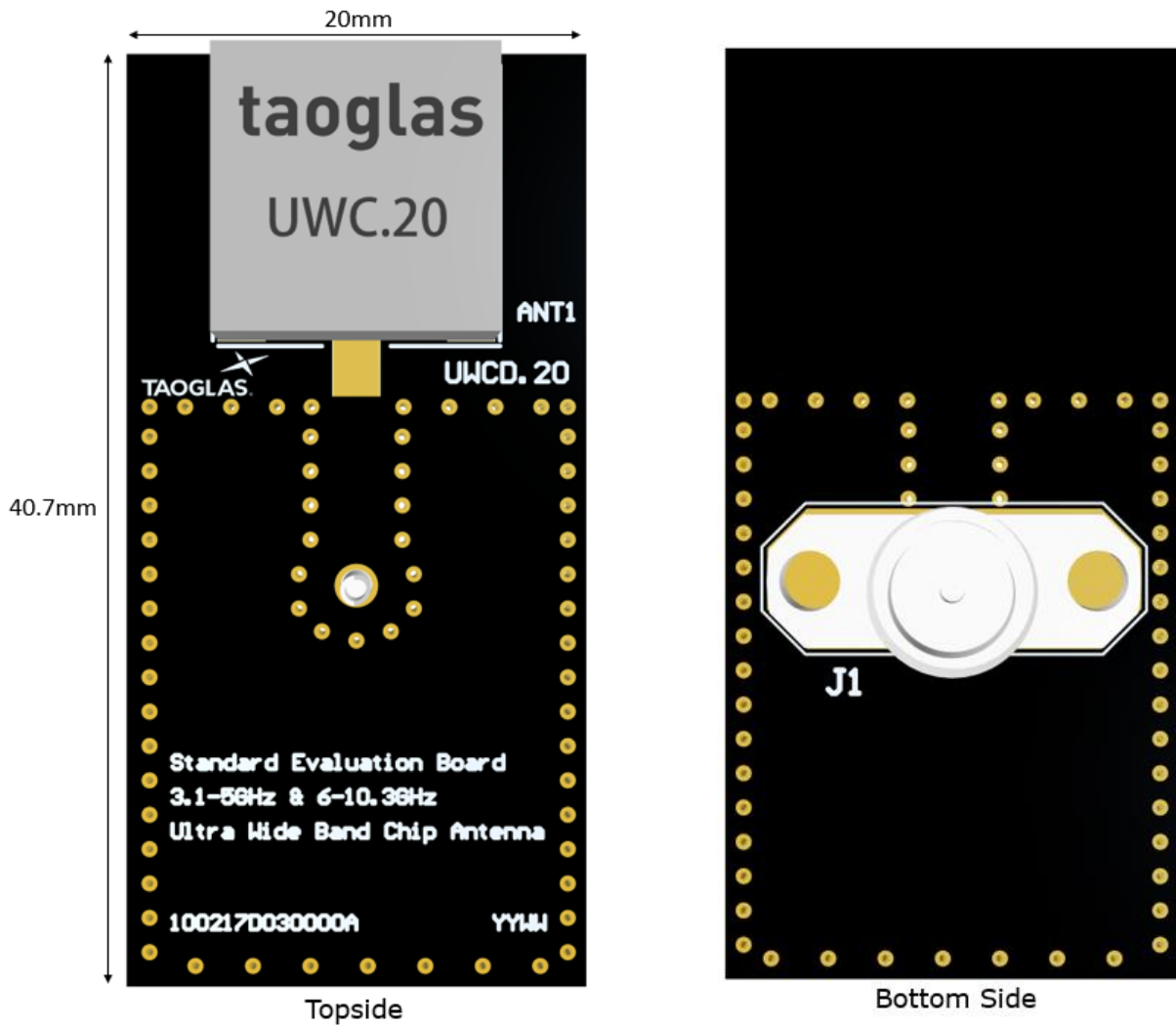

6.6 PCB Footprint Information

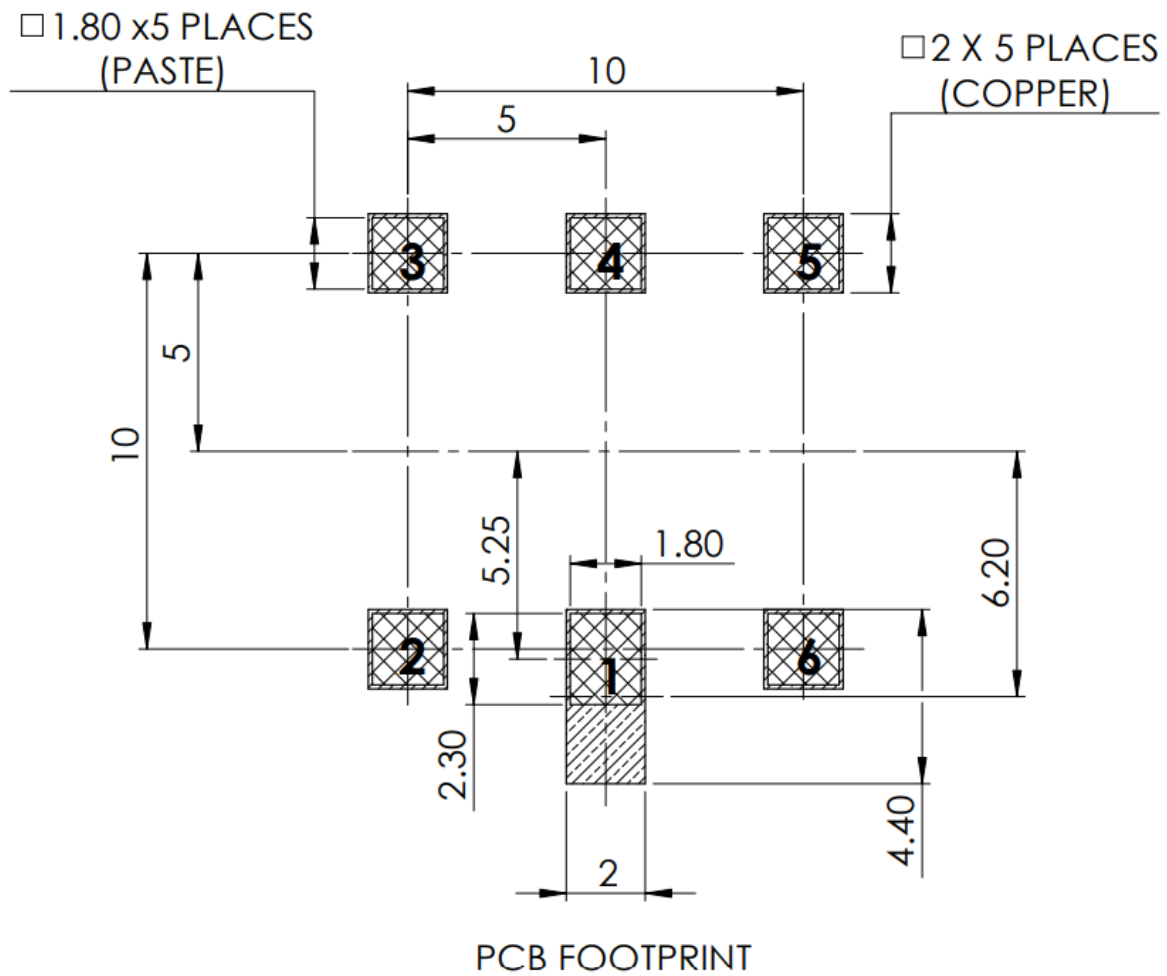

<u>PIN:</u>	<u>DESCRIPTION:</u>
1	Feed (50 ohm)
2,3,4,5,6	NC

7. Solder Reflow Profile

The UWC.20 can be assembled by following the recommended soldering temperatures are as follows:

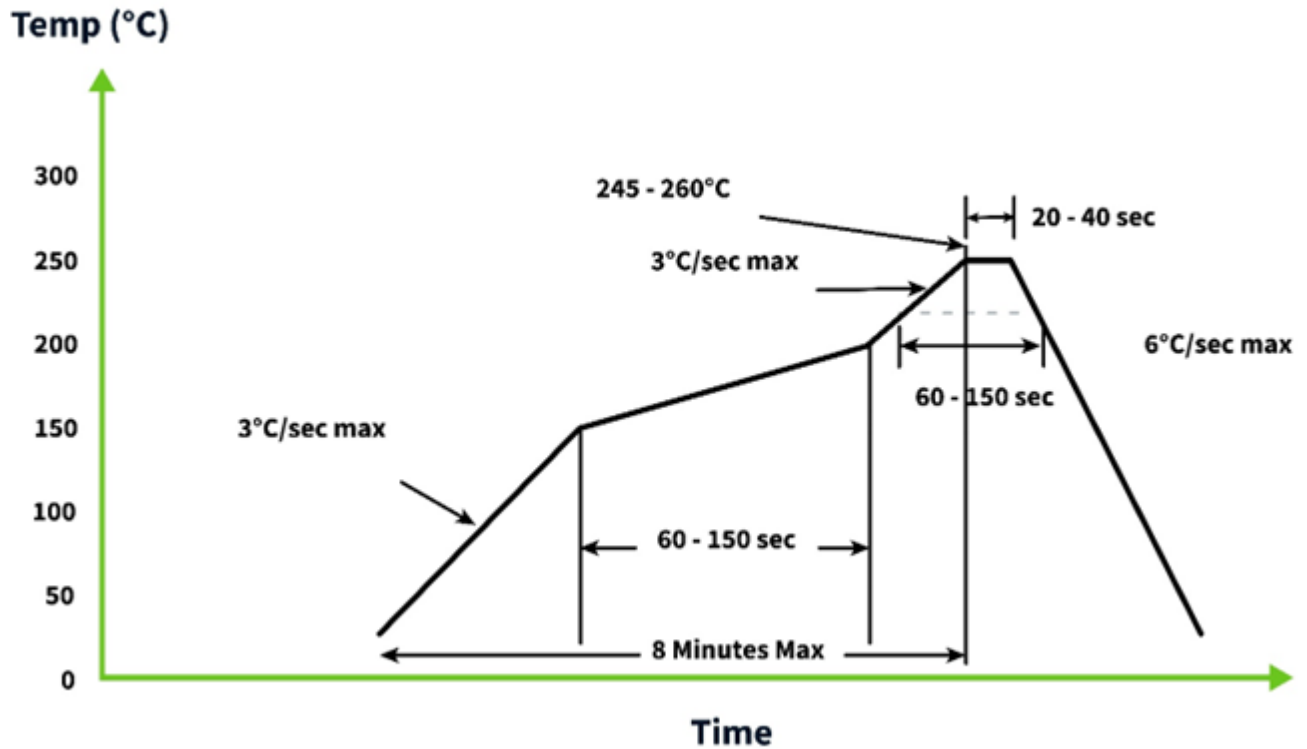

*Temperatures listed within a tolerance of +/- 10° C

Smaller components are typically mounted on the first pass, however, we do advise mounting the UWC.20 when placing larger components on the board during subsequent reflows.

Note: Soldering flux classified ROL0 under IPC J-STD-004 is recommended.

8. Packaging

600 pc UWC.20 per reel
 Dimensions - $\varnothing 330 \times 20.4 \text{mm}$
 Weight - 2.46Kg

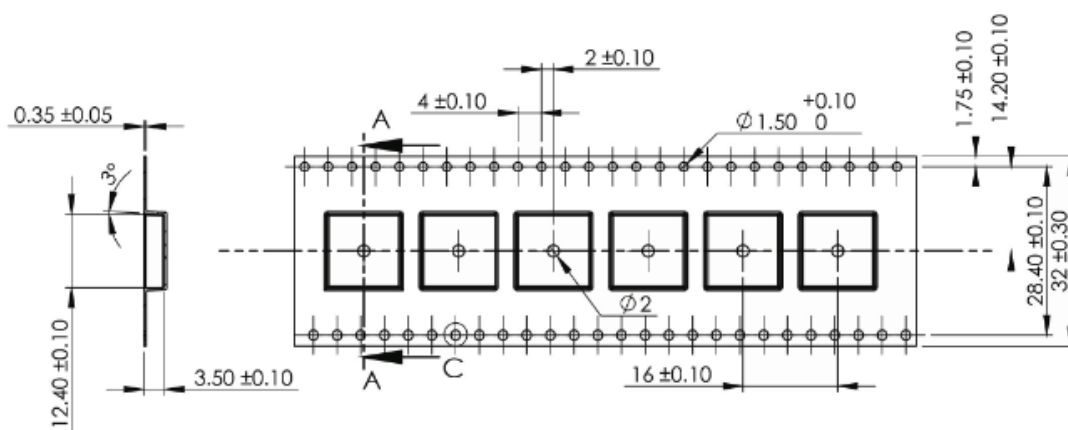
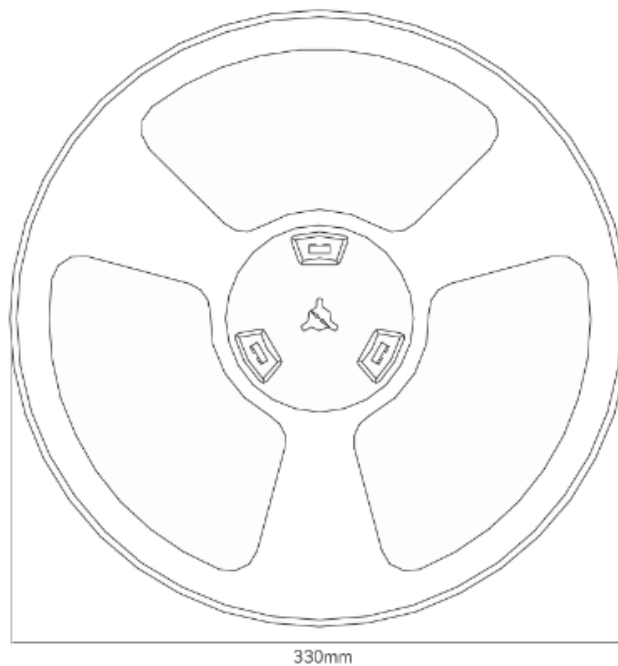

600 pc UWC.20 per reel
 Dimensions - Ø330*20.4mm
 Weight - 2.46Kg



600 pcs UWC.20 / 1 Reel in small box
 Dimensions - 350*340*47mm
 Weight - 2.76Kg

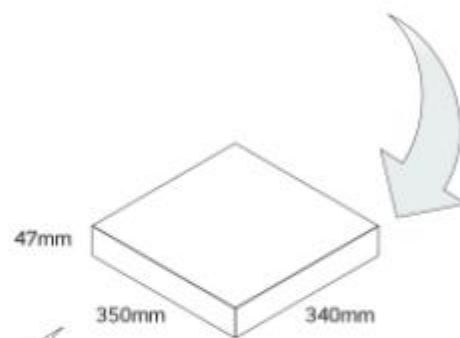

5 small boxes, 3000 pcs in one carton
 Carton Dimensions - 360*370*275mm
 Weight - 13.8Kg

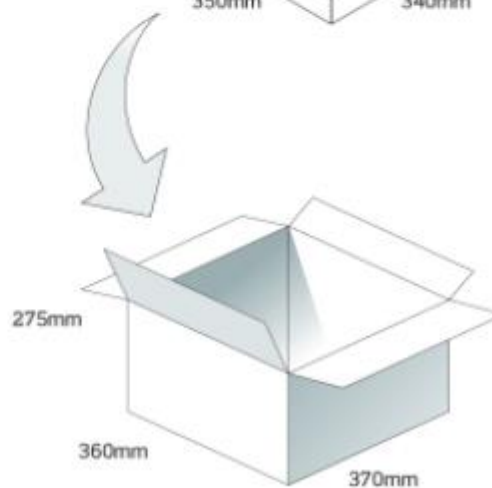

9.2 Ground Plane Size

Influence of ground plane length and width is tested. Graphs below show that there is influence on S11 and on Efficiency when the ground plane length is increased in both lower band (3 – 5 GHz) and higher band (6 – 9 GHz). Results in this section should be taken into consideration when choosing the PCB size. Length shorter than 10 mm is not recommended.

When the ground plane width is increased both S11 and efficiency are not significantly influenced, except for width 16 mm which has negative influence on performance in channel 5 (6-7 GHz).

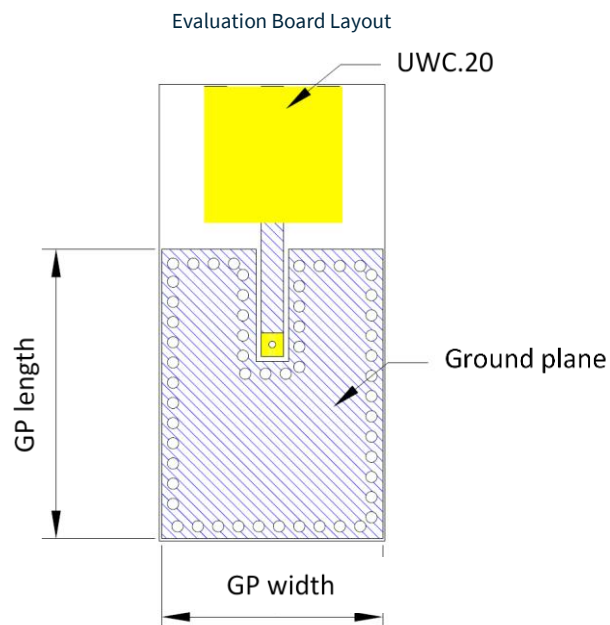

8.3 Ground Plane Length

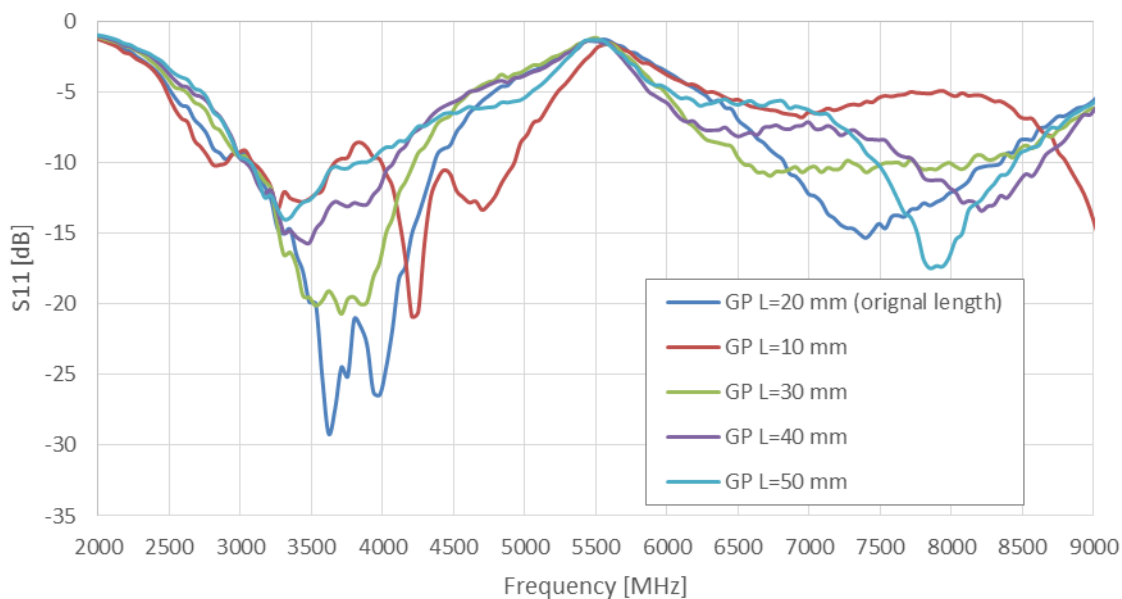

Return loss for ground plane length variation

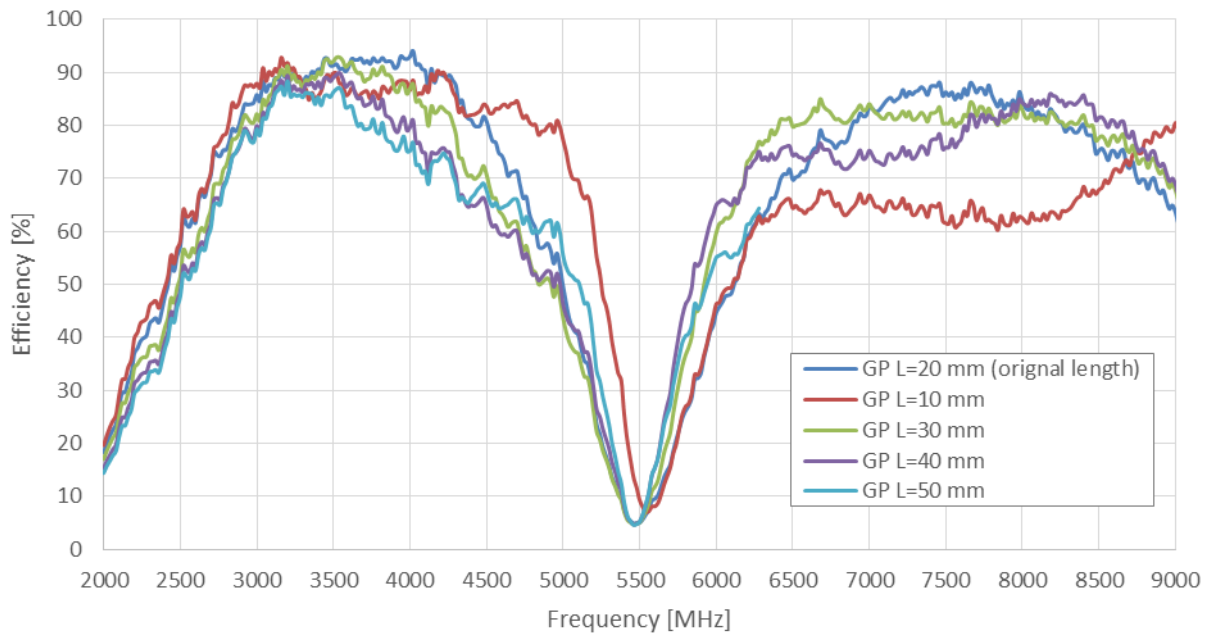

Efficiency for ground plane length variation

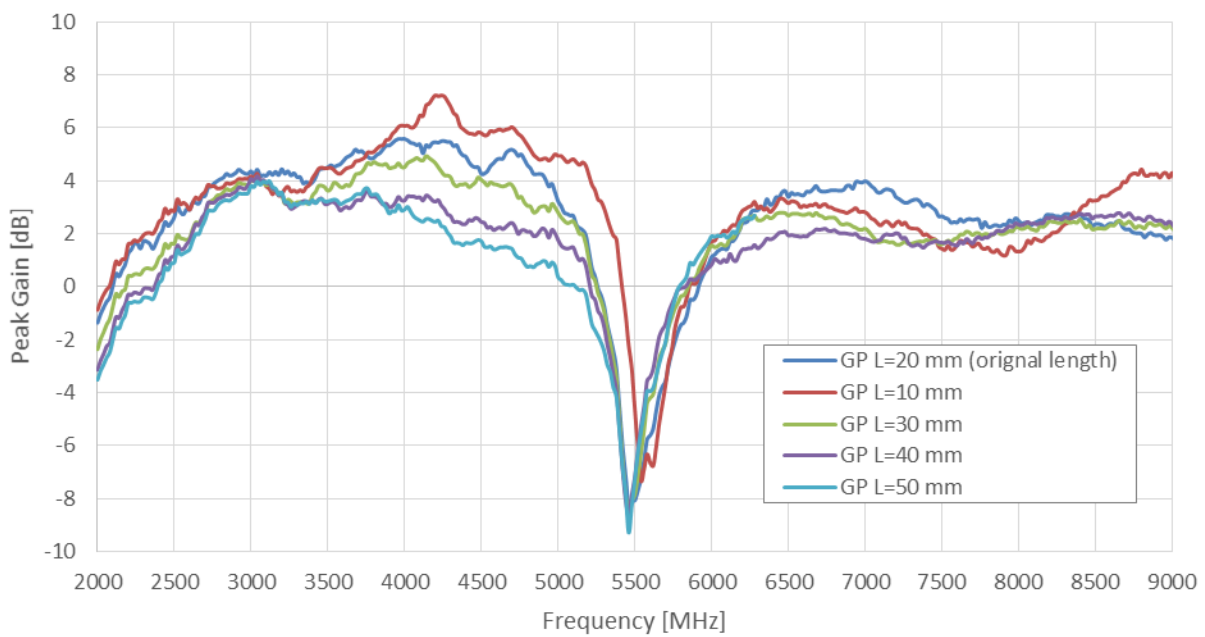

Peak gain for ground plane length variation

9.4 Ground Plane Width

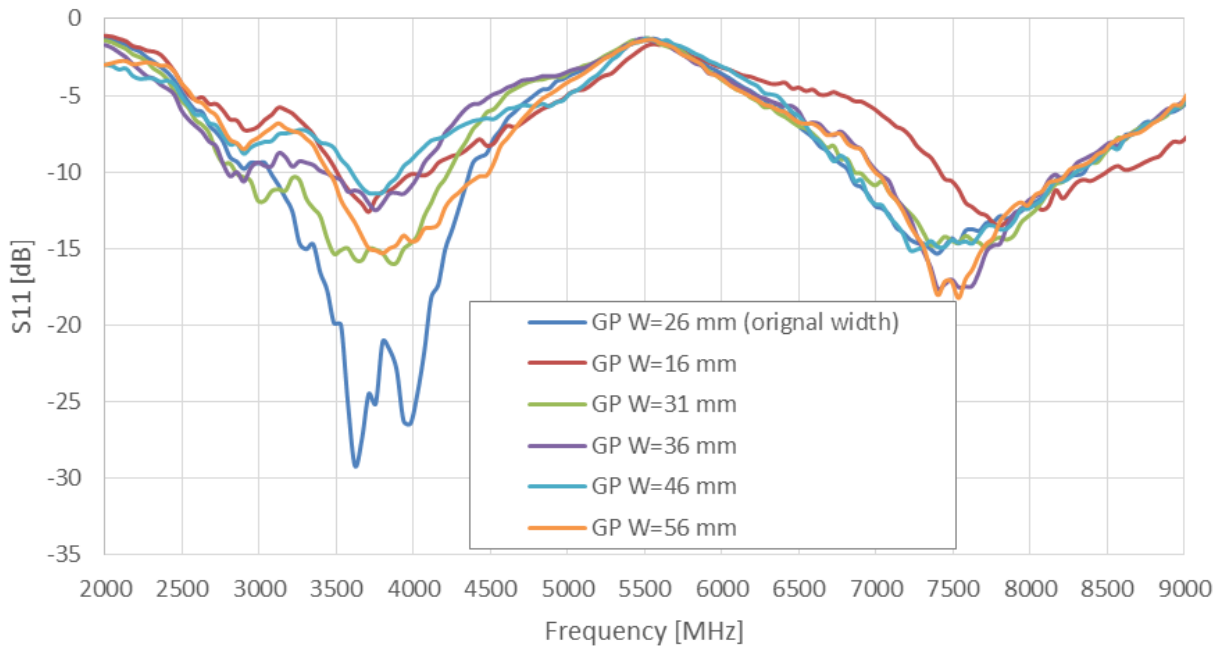

Return loss for ground plane width variation

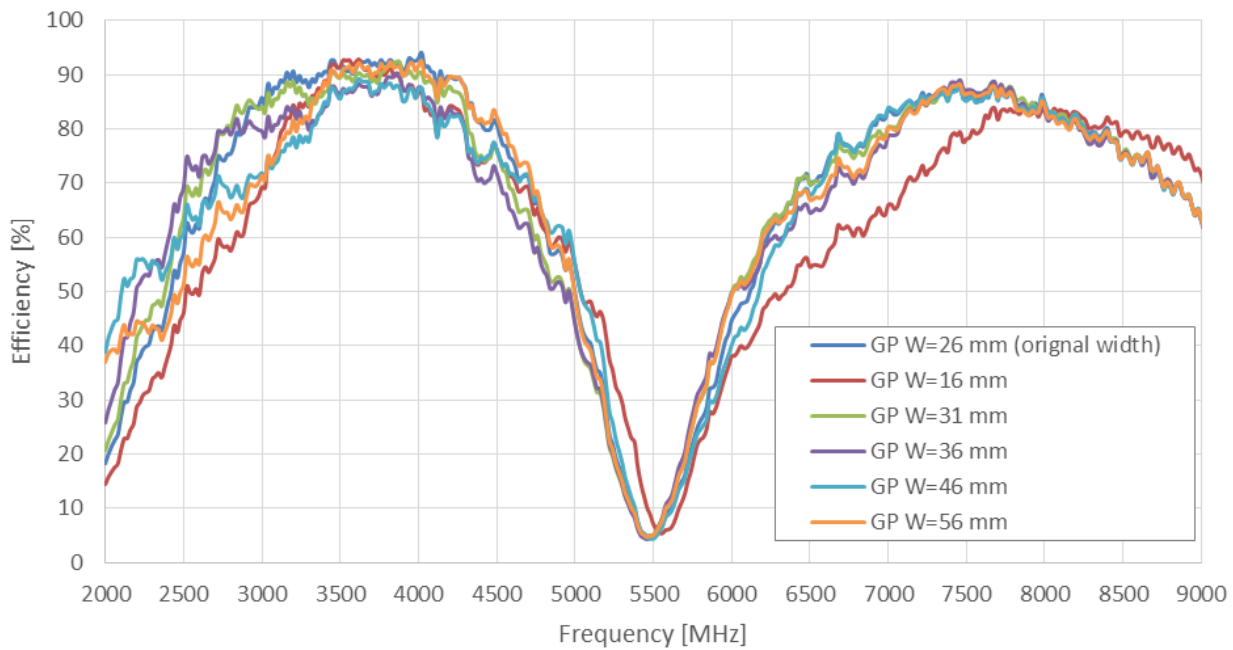

Efficiency for ground plane width variation

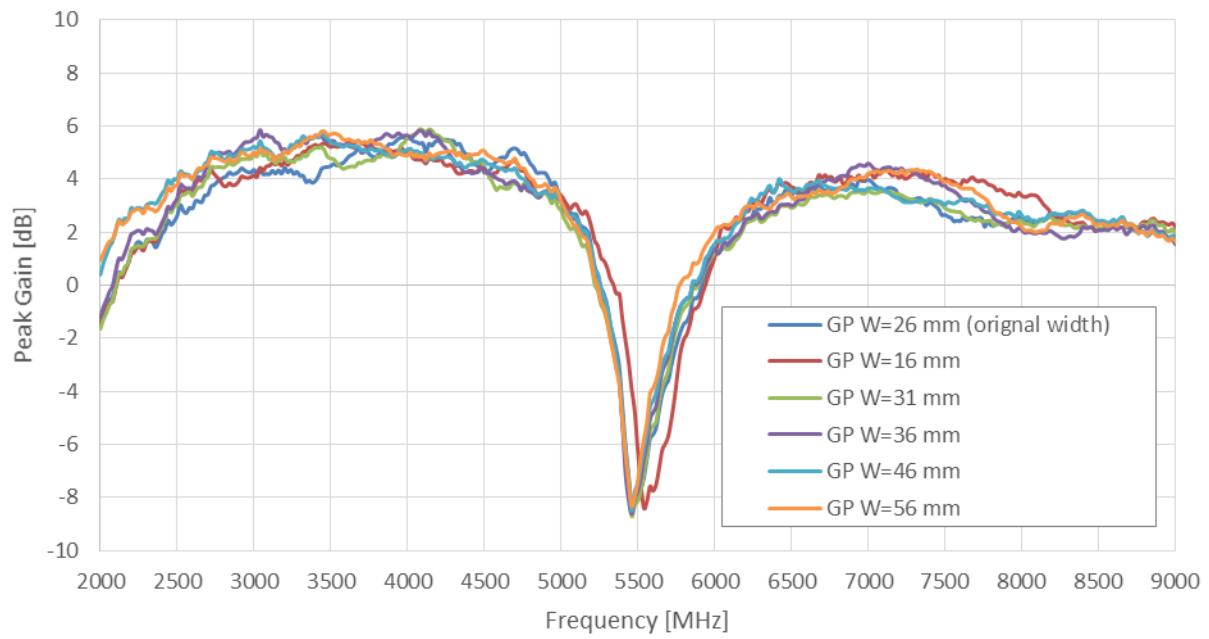

Peak Gain for ground plane width variation

9.5 Case Study

A metal clearance study is also performed. A 5*5*2mm metal component is placed on different locations around the UWC.20 antenna as shown.

The results show that close proximity of components on the left and right of the antenna will not influence performance, nor as will a component placed on the ground plane edge below the antenna. Note that clearance between the antenna and ground plane shall be kept at 2.44 mm.

From this follows that for optimum performance it is advised to keep any component at least 1 mm from the antenna.

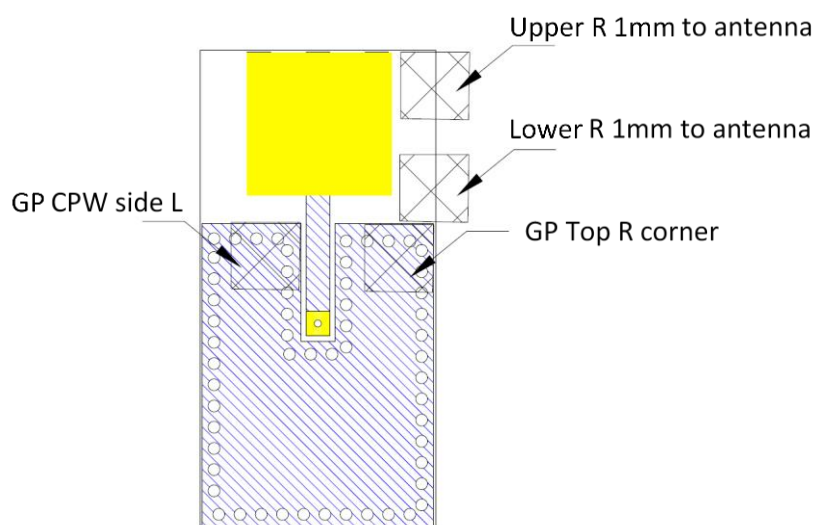

Clearance study - metal component locations

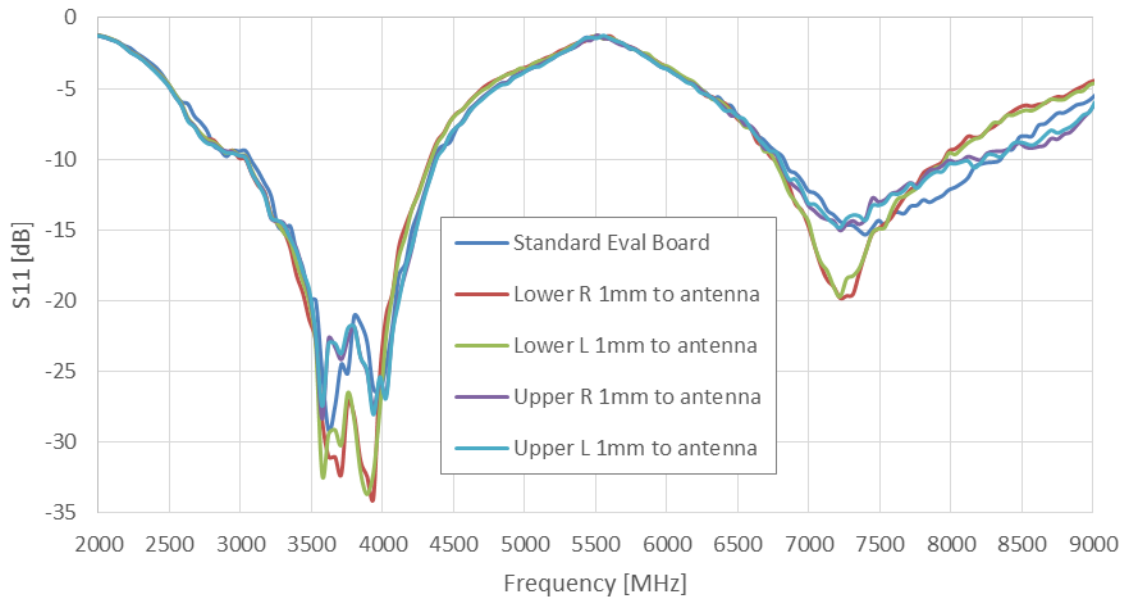

Return loss for clearance study (metal component next to antenna)

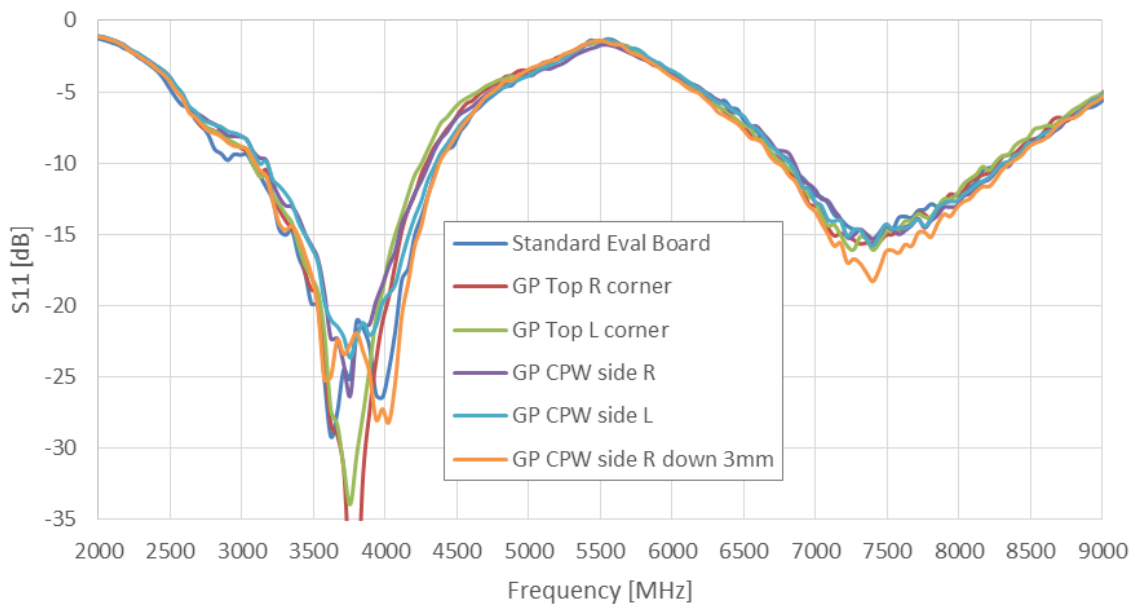

Return loss for clearance study (metal component on the edge of ground plane)

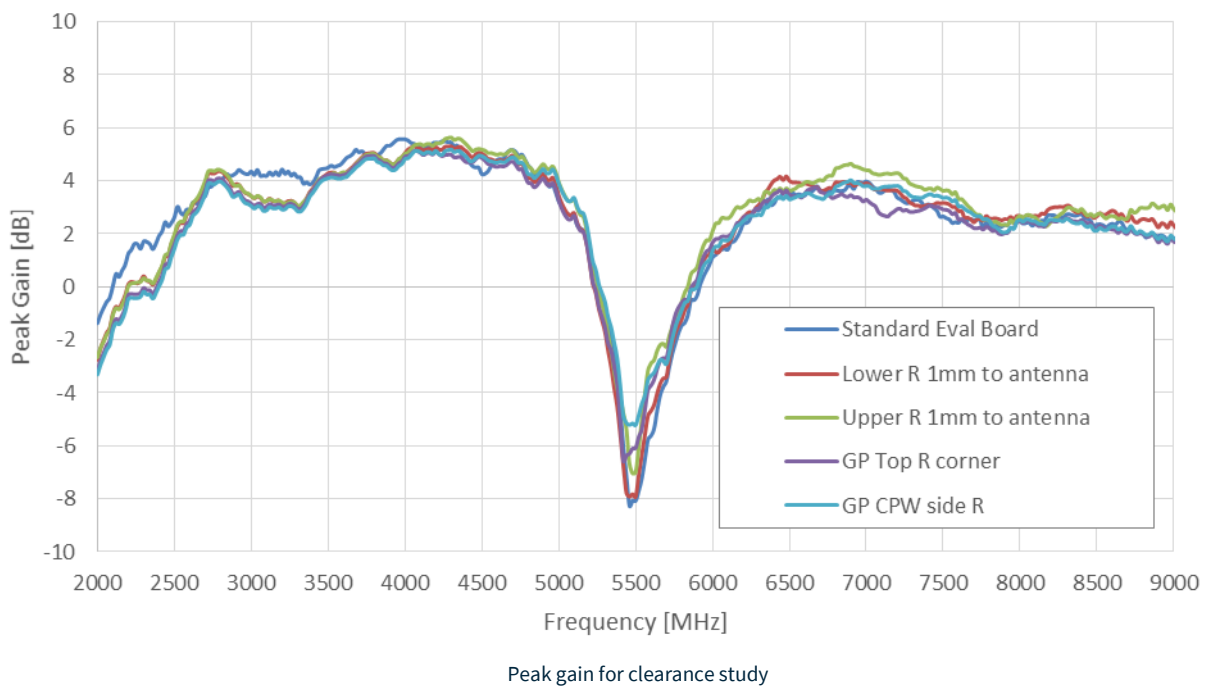
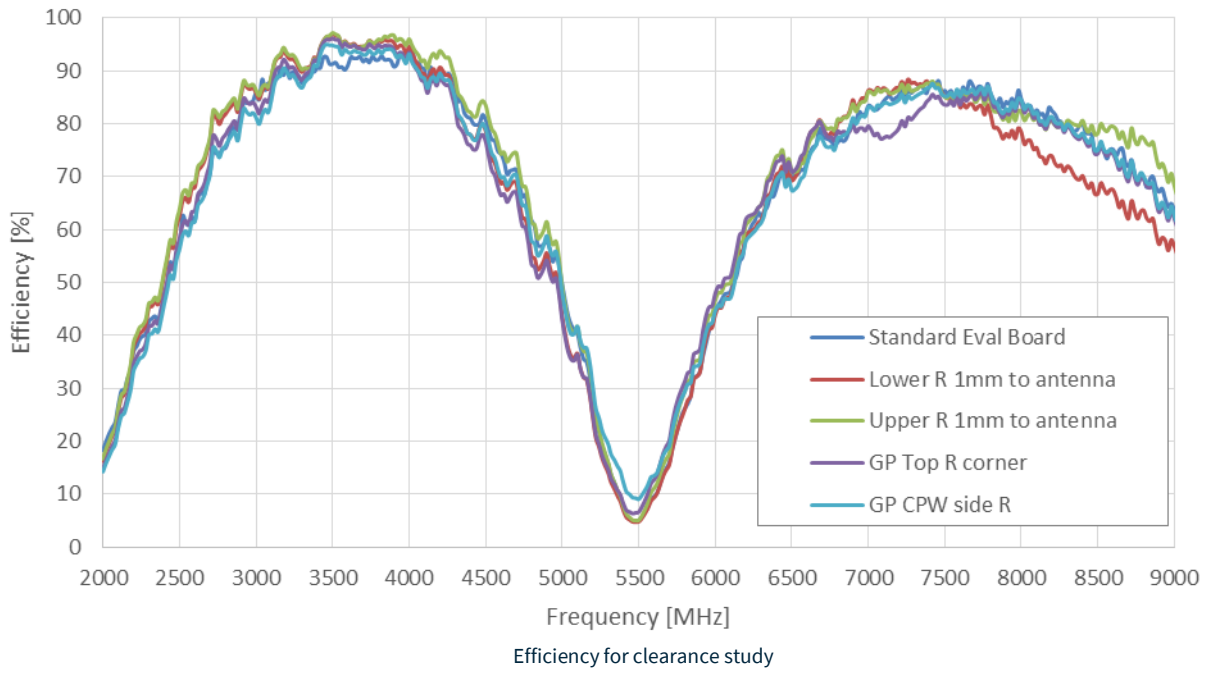

Changelog for the datasheet

SPE-17-8-056 – UWC.20

Revision: F (Current Version)

Date:	2023-09-06
Changes:	Added Solder Reflow Information
Changes Made by:	Cesar Sousa

Previous Revisions

Revision: E

Date:	2022-06-08
Changes:	Antenna temperature range updated. (ISO16750-4 - 5.1.2.2)
Changes Made by:	Gary West

Revision: D

Date:	2021-10-04
Changes:	Added MSL level to spec table
Changes Made by:	Gary West

Revision: C

Date:	2021-05-06
Changes:	Updated datasheet template and added antenna integration guide
Changes Made by:	Gary West

Revision: B

Date:	2018-08-02
Changes:	Updated drawing Figure 3. Application Note
Changes Made by:	Carol Faughnan

Revision: A (Original First Release)

Date:	2017-09-12
Notes:	First Release
Author:	Andela Zaric



TAOGLAS®

www.taoglas.com

