



# TAOGLAS®



# Datasheet

**Part No:**  
TI.09.A.0111

**Description:**  
915MHz ISM/LoRA Terminal Mount Antenna

**Features:**  
0dBi Peak Gain Antenna  
High Efficiency  
SMA Male Straight Connector  
Dimensions: 168\* $\varnothing$ 12mm  
RoHS & REACH Compliant

1.	Introduction	3
2.	Specifications	4
3.	Antenna Characteristics	5
4.	Radiation Patterns	7
5.	Mechanical Drawing	11
6.	Packaging	12
<hr/>		
	Changelog	13

Taoglas makes no warranties based on the accuracy or completeness of the contents of this document and reserves the right to make changes to specifications and product descriptions at any time without notice. Taoglas reserves all rights to this document and the information contained herein. Reproduction, use or disclosure to third parties without express permission is strictly prohibited.



## 1. Introduction



The Taoglas TI.09.A.0111 is a Dipole antenna designed to operate on the LoRA/ISM/Helium network at 915MHz. It is 168mm tall and can be mounted directly to a device via the SMA male connector integrated into the bottom side of the antenna. This antenna performs very well in free space with over 45 percent efficiency, making it an ideal solution in areas where there may be no ground plane.

Typical Applications include:

- Smart Metering
- Remote Monitoring
- Industrial IoT
- Connected Enterprise

The TI.09.A.0111 is manufactured using robust TPU Material making it suitable for mounting in outdoor areas if required. This antenna's connector can be customised subject to MOQ, please contact your regional Taoglas customer support team for installation guidelines or additional support to integrate and test this antenna's performance in your device.

## 2. Specifications

Electrical	
Frequency (MHz)	915ISM
	902-928
Efficiency (%)	
Free space	47.8
On 9 X 15cm ground plane	57.0
On 15 X 9cm ground plane	48.0
Average Gain (dB)	
Free space	-3.21
On 9 X 15cm ground plane	-2.44
On 15 X 9cm ground plane	-3.19
Peak Gain (dBi)	
Free space	-0.89
On 9 X 15cm ground plane	2.17
On 15 X 9cm ground plane	0.41
Impedance	50 Ω
Polarization	Vertical
Radiation Pattern	Omni
Mechanical	
Dimensions	168x12mm
Weight	21g
Material	TPU
Connector	SMA (M) ST
Environmental	
Temperature Range	-40°C ~ +85°C
Storage Temperature	-40°C ~ +85°C

### 3. Antenna Characteristics

#### 3.1 Return Loss

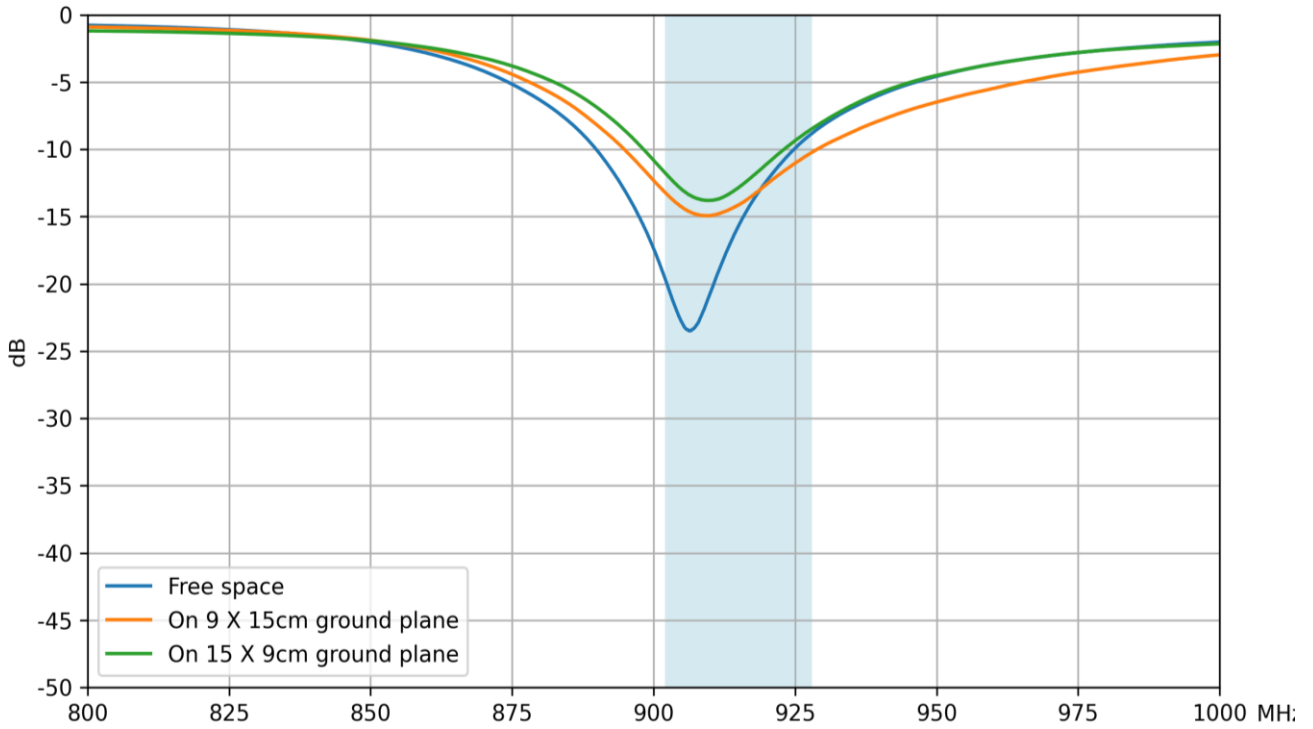

#### 3.2 Efficiency

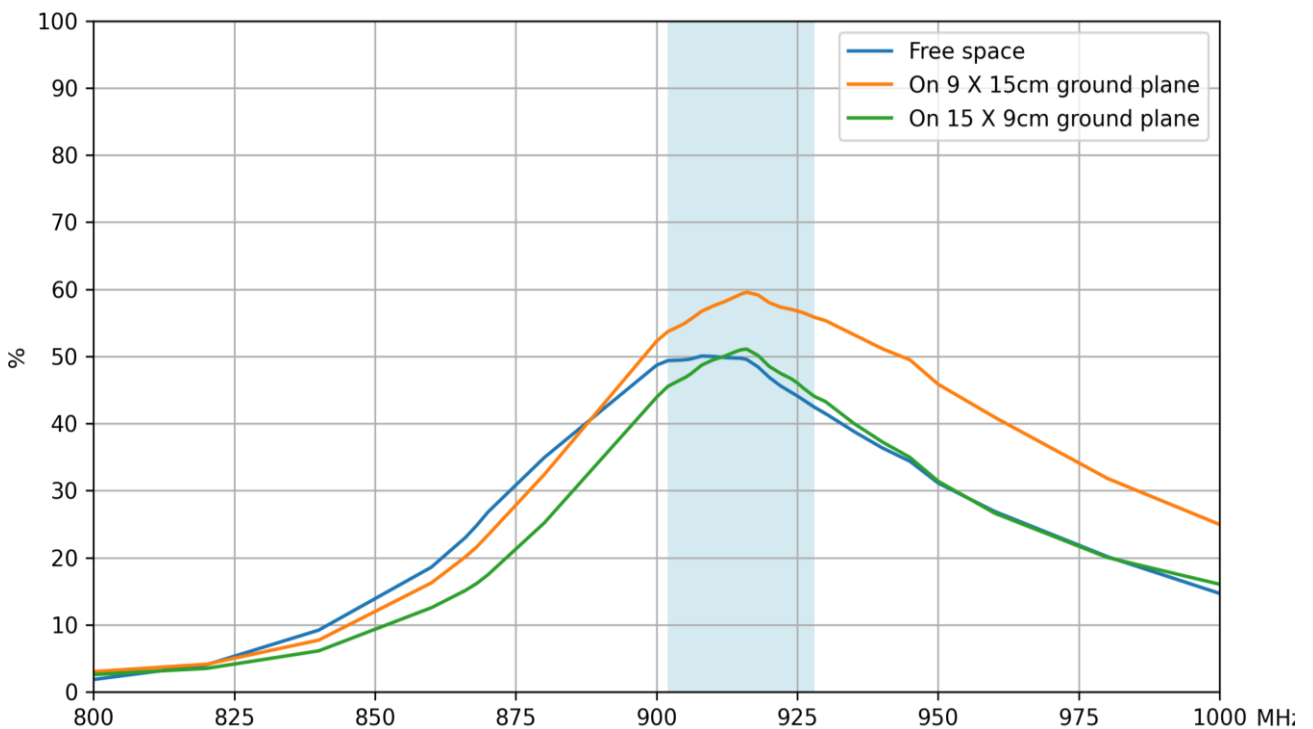

### 3.3 Average Gain

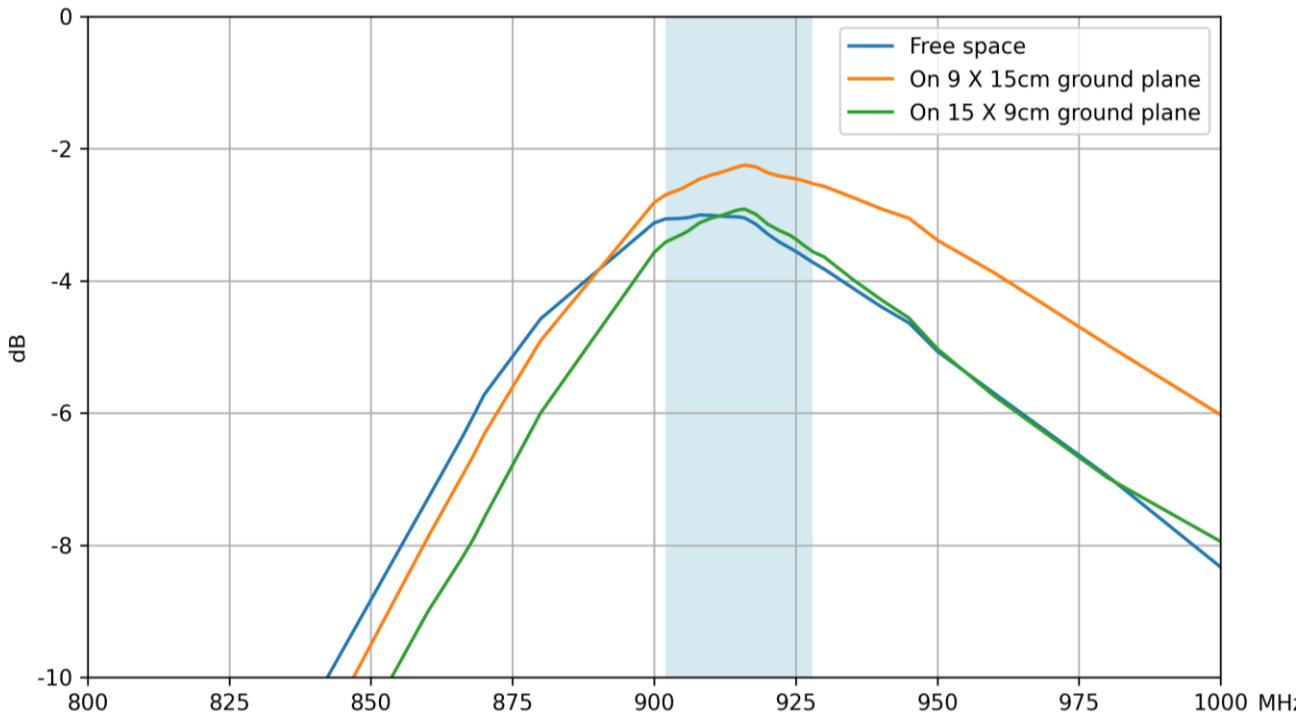

### 3.4 Peak Gain

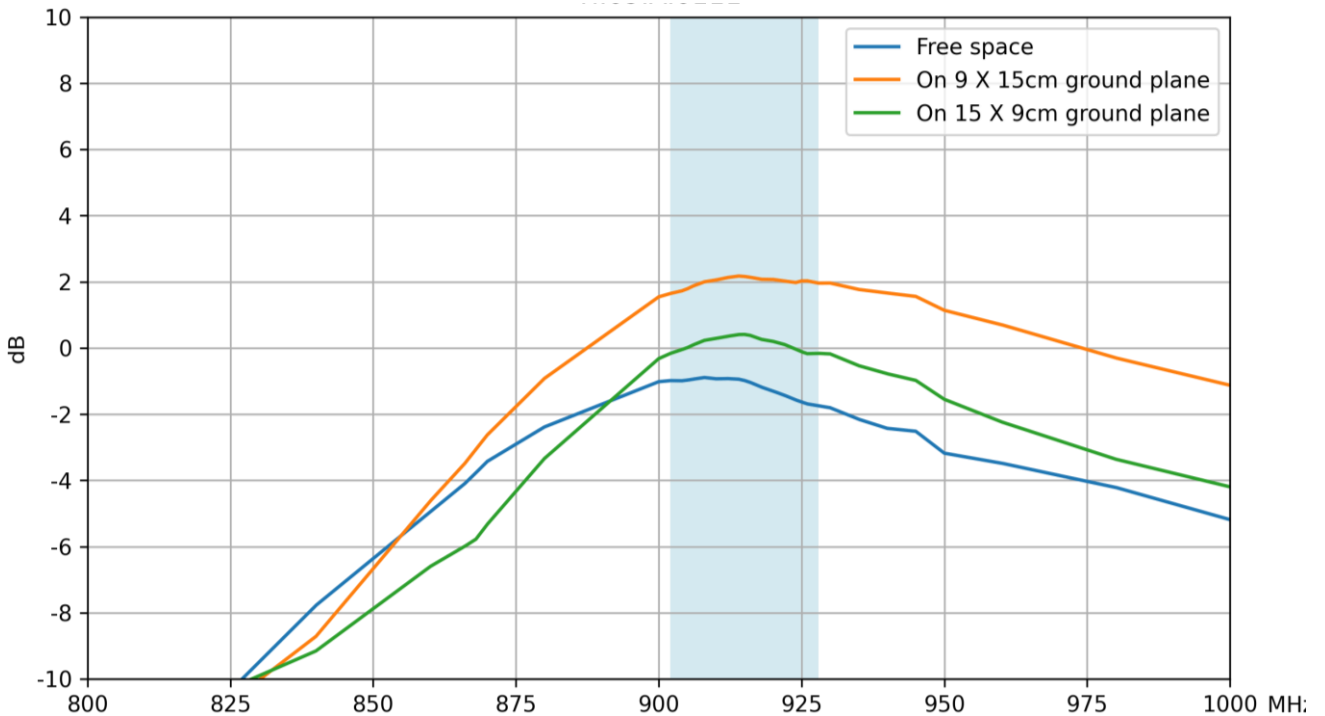

## 4. Radiation Patterns

### 4.1 Test Setup - Chamber

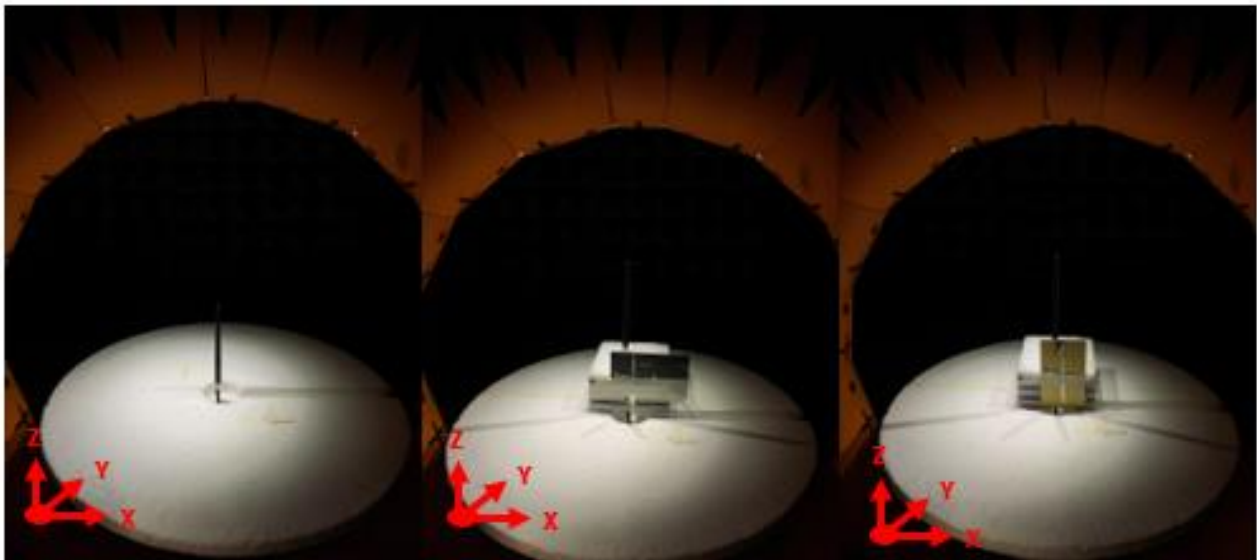

Freespace

On 9x15cm Ground Plane (long side)

On 15x9cm Ground Plane (short side)

### 4.2 Test Setup - VNA

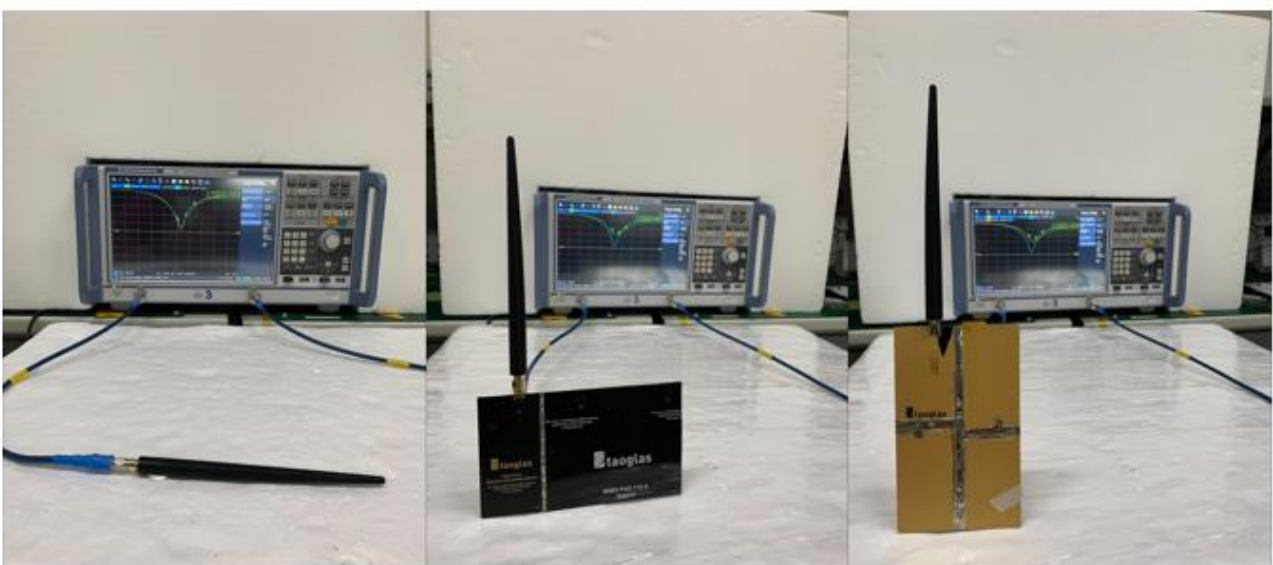

Freespace

On 9x15cm Ground Plane (long side)

On 15x9cm Ground Plane (short side)

4.2 902MHz\_Freespace - 2D & 3D Radiation Patterns

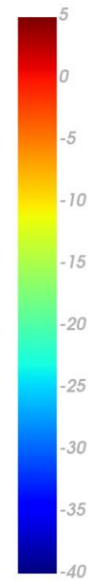
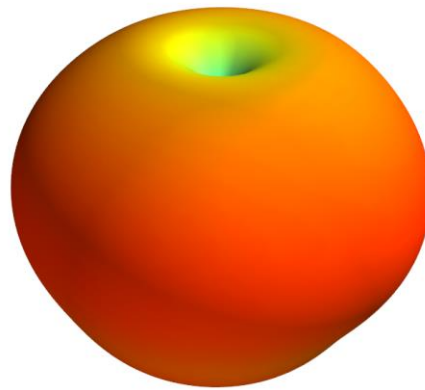

XY Plane

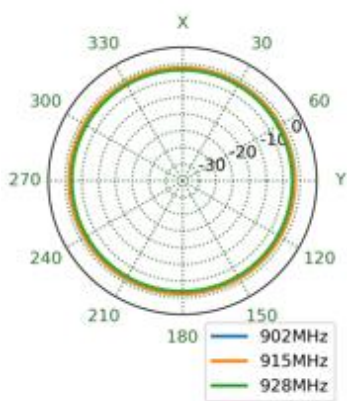

XZ Plane

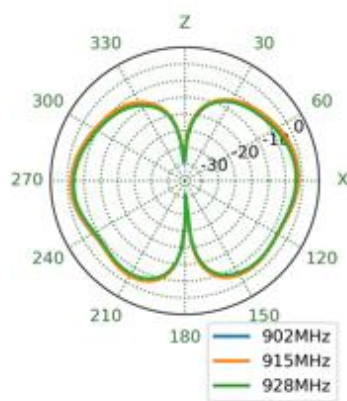

YZ Plane

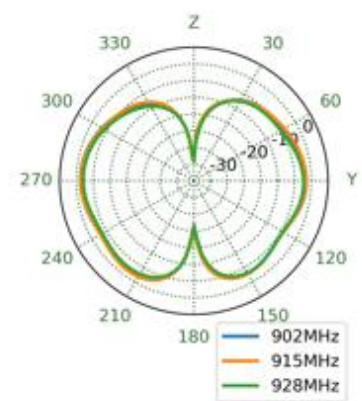



4.3 915MHz\_On 9x15cm Ground plane - 2D & 3D Radiation Patterns

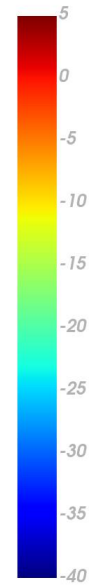
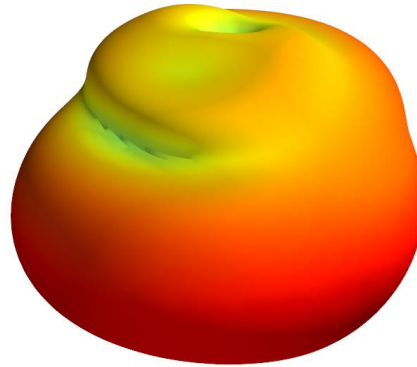

XY Plane                      XZ Plane                      YZ Plane

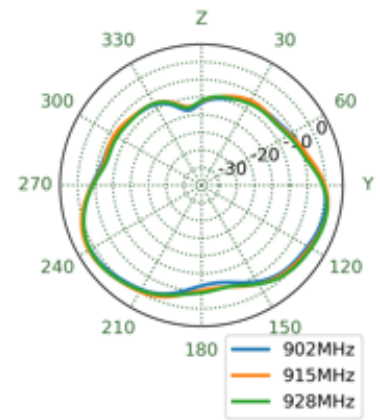
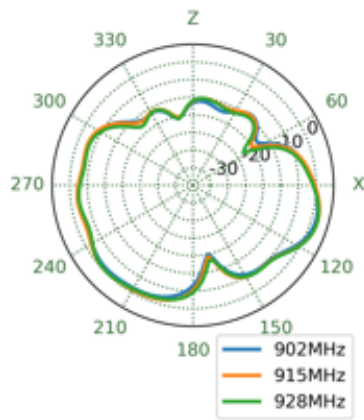
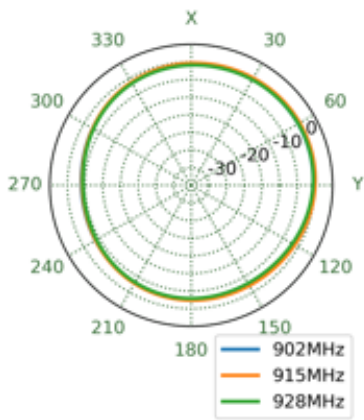

4.4 928MHz\_On 15x9cm Ground plane - 2D & 3D Radiation Patterns

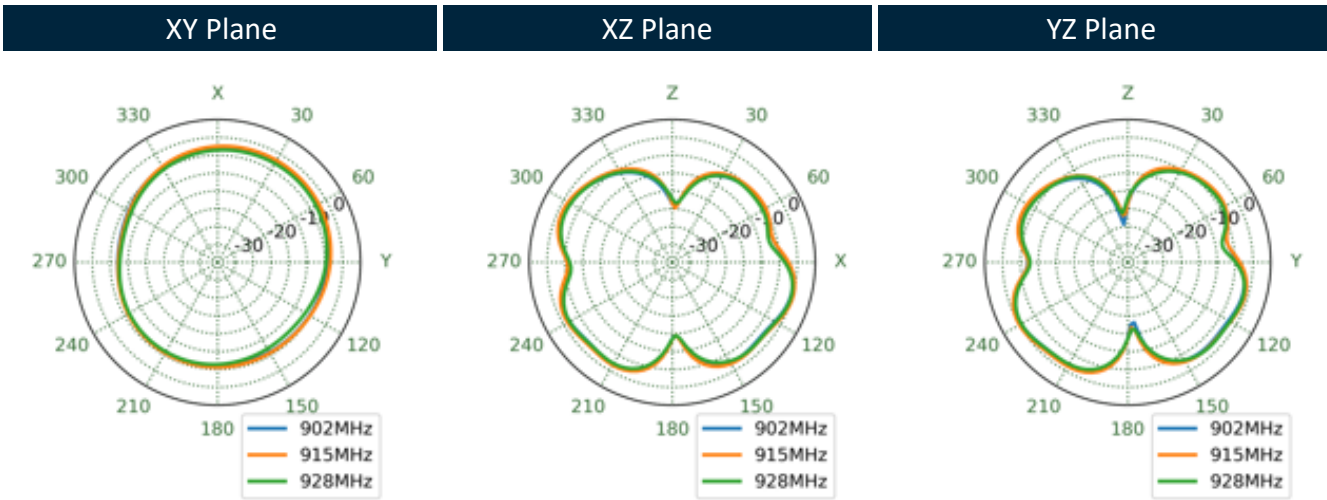
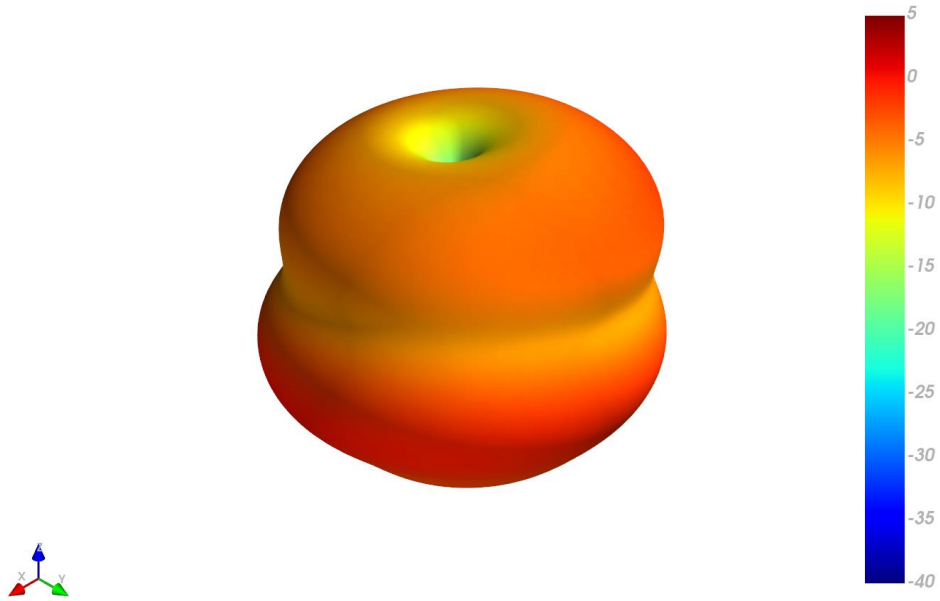

## 5. Mechanical Drawing (Units: mm)

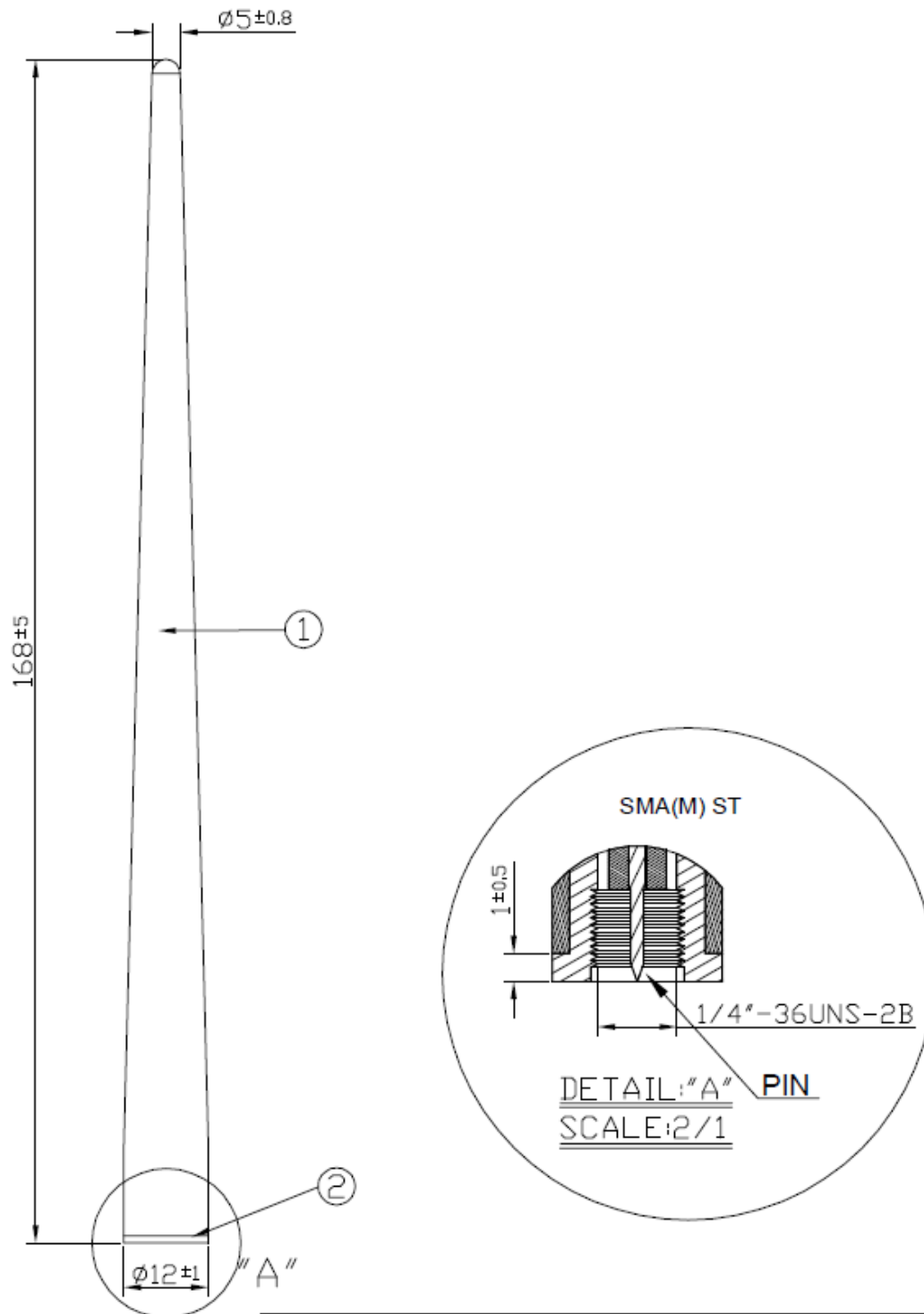

	Name	P/N	Material	Finish	QTY
①	Antenna Housing	000111L000002A	TPU	Black	1
②	SMA(M) ST	210211L000002A	Brass	Black	1

## 6. Packaging

1 pcs TI.09.A.0111 per PE Bag  
 PE Bag Dimensions - 150\*260mm  
 Weight - 0.021kg



100 PE Bags per Large PE Bag  
 100 pcs TI.09.A.0111 per Large PE Bag  
 Large PE Dimensions - 250\*480mm  
 Weight - 0.221kg

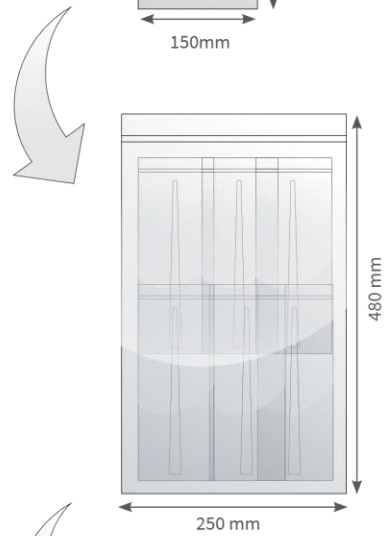

15 Large PE bags per carton  
 1500 pcs TI.09.A.0111 per carton  
 Carton Dimensions - 360\*310\*160mm  
 Weight - 3.915kg

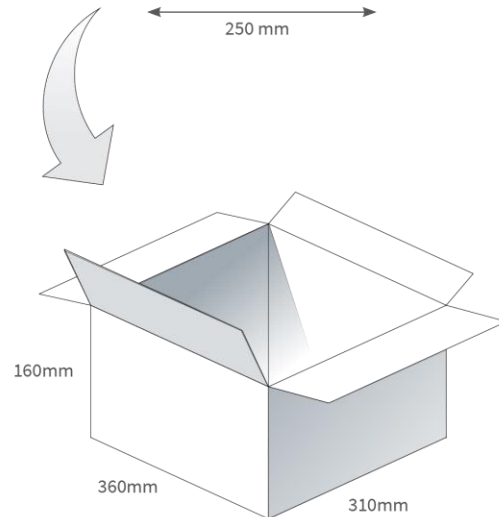

Changelog for the datasheet

**SPE-15-8-018 – TI.09.A.0111**

<b>Revision: B (Current Version)</b>	
Date:	2022-06-07
Changes:	Full datasheet update
Changes Made by:	Gary West

**Previous Revisions**

<b>Revision: A (Original First Release)</b>	
Date:	2015-04-23
Notes:	
Author:	Technical Writer



[www.taoglas.com](http://www.taoglas.com)

