

PLCC2 SMD Top View Package LED SMTL2-OC, ORANGE

BIVAR

SMTL2-OC

- ◆ Industry Standard PLCC2 Footprint
- ◆ Low Profile Package
- ◆ High Luminous Intensity
- ◆ Wide Viewing Angle
- ◆ High Power Efficiency



Bivar SMTL2 LED is offered in an industry standard PLCC2 package with high luminous intensity and wide viewing angles. The miniature package is ideal for small scale applications such as illumination, general indication, and backlighting. Low power consumption and excellent long life reliability are suitable for battery powered equipment. The robust package is ideal for harsh working environments and can be used in clusters for high luminous applications. Wide variety of color and intensity combinations are available to meet any illumination needs. Bivar SMTL2 LED is packaged in standard tape and reels for pick and place assemblies.

Part Number	Material	Emitted Color	Lumen Typ. mcd	Lens Color	Viewing Angle
SMTL2-OC	AlGaInP	Orange	270	Water Clear	120°

Outline Dimensions

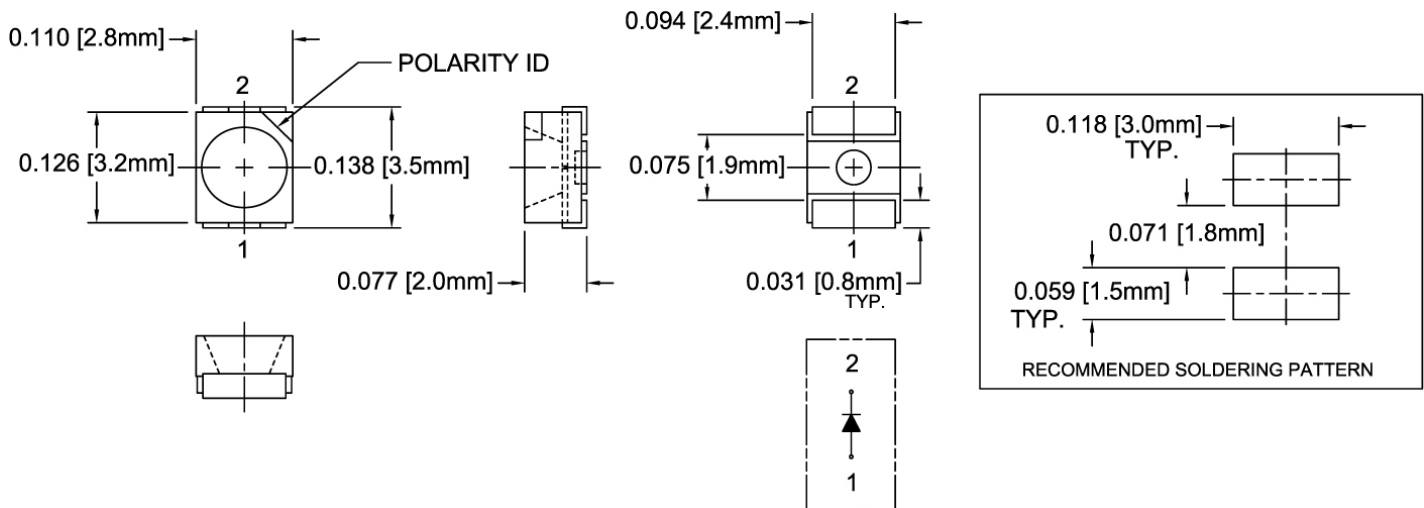

Outline Drawings Notes:
 1. All dimensions are in inches [millimeters].
 2. Standard tolerance: $\pm 0.010''$ unless otherwise noted.



Bivar reserves the right to make changes at any time without notice.

PLCC2 SMD Top View Package LED SMTL2-OC, ORANGE



Absolute Maximum Ratings

$T_A = 25^\circ\text{C}$ unless otherwise noted

Power Dissipation	72 mW
Continuous Forward Current	30 mA
Peak Forward Current ¹	100 mA
Reverse Voltage	5 V
Derating Linear From 25°C	0.4 mA/°C
Operating Temperature Range	-40 ~ +85°C
Storage Temperature Range	-40 ~ +100°C
Lead Soldering Temperature (1.6 mm from body) ²	260°C
Electrostatic Discharge (HBM)	2000 V

- Notes: 1. 10% Duty Cycle, Pulse Width ≤ 0.1 msec.
2. Solder time less than 5 seconds at temperature extreme.

Electrical Characteristics

$T_A = 25^\circ\text{C}$ & $I_F = 20$ mA unless otherwise noted

Emitting Color	Forward Voltage (V) ¹		Recommend Forward Current (mA)	Reverse Current (μA) $V_R=5\text{V}$	Dominant Wavelength (nm) ²			Luminous Intensity (mcd) ³		Viewing Angle $2\theta_{1/2}$ (deg)
	TYP	MAX	TYP	MAX	MIN	TYP	MAX	MIN	TYP	TYP
Orange	1.9	2.4	20	100	598	605	614	180	270	120

- Notes: 1. Tolerance of Forward Voltage : $\pm 0.05\text{V}$.
2. Tolerance of Dominant Wavelength : $\pm 0.1\text{nm}$.
3. Tolerance of Luminous Intensity : $\pm 15\%$.

Directivity Radiation

$T_A = 25^\circ\text{C}$ unless otherwise noted



Radiation Diagram

Bivar reserves the right to make changes at any time without notice.

PLCC2 SMD Top View Package LED SMTL2-OC, ORANGE



Typical Electrical / Optical Characteristics Curves

$T_A = 25^\circ\text{C}$ unless otherwise noted

Relative Spectrum Emission $I_{rel} = f(\lambda)$, $T_A = 25^\circ\text{C}$, $I_F = 20\text{ mA}$
 $V(\lambda) = \text{Standard eye response curve}$

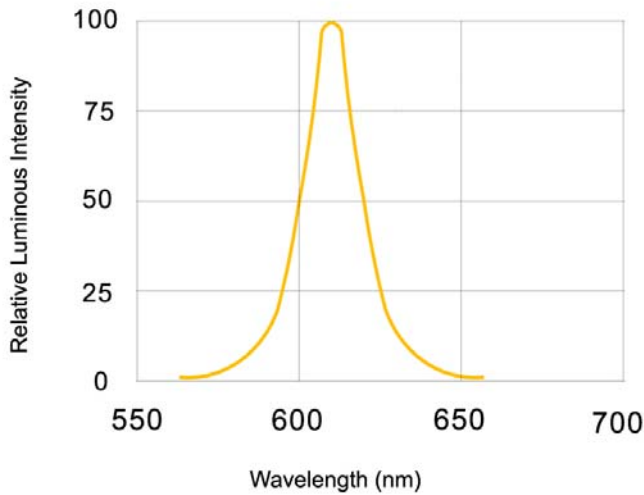

Fig.1 Relative Luminous Intensity vs. Wavelength

Forward Current $I_F = f(V_F)$
 $T_A = 25^\circ\text{C}$

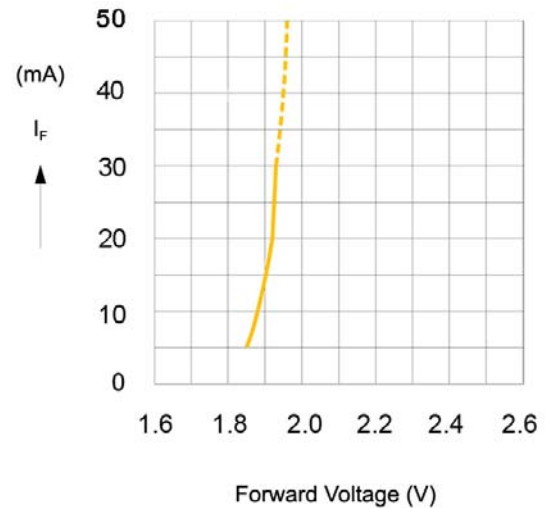

Fig.2 Forward Current vs. Forward Voltage

Relative Luminous Intensity $I_V/I_V(20\text{ mA}) = f(I_F)$
 $T_A = 25^\circ\text{C}$

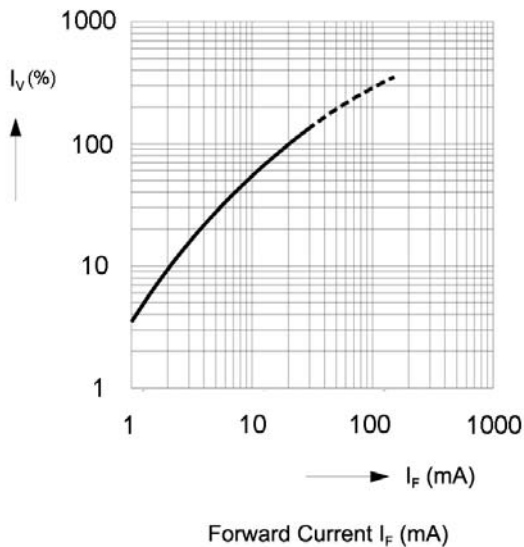

Fig.3 Relative Luminous Intensity vs. Forward Current

Ambient Temperature vs. Allowable Forward Current

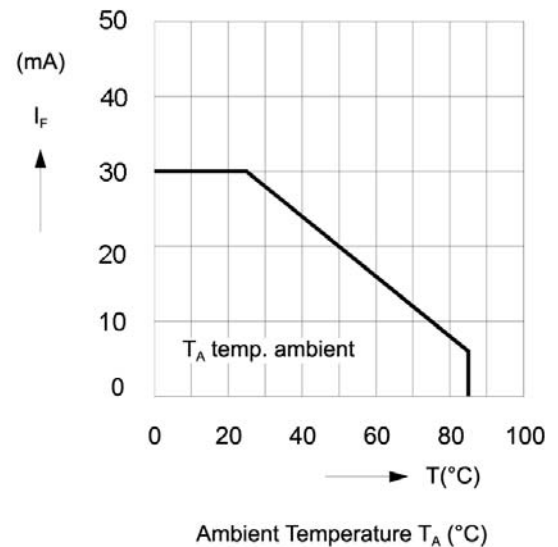

Fig.4 Forward Current vs. Ambient Temperature

Bivar reserves the right to make changes at any time without notice.

PLCC2 SMD Top View Package LED SMTL2-OC, ORANGE



Recommended Soldering Conditions

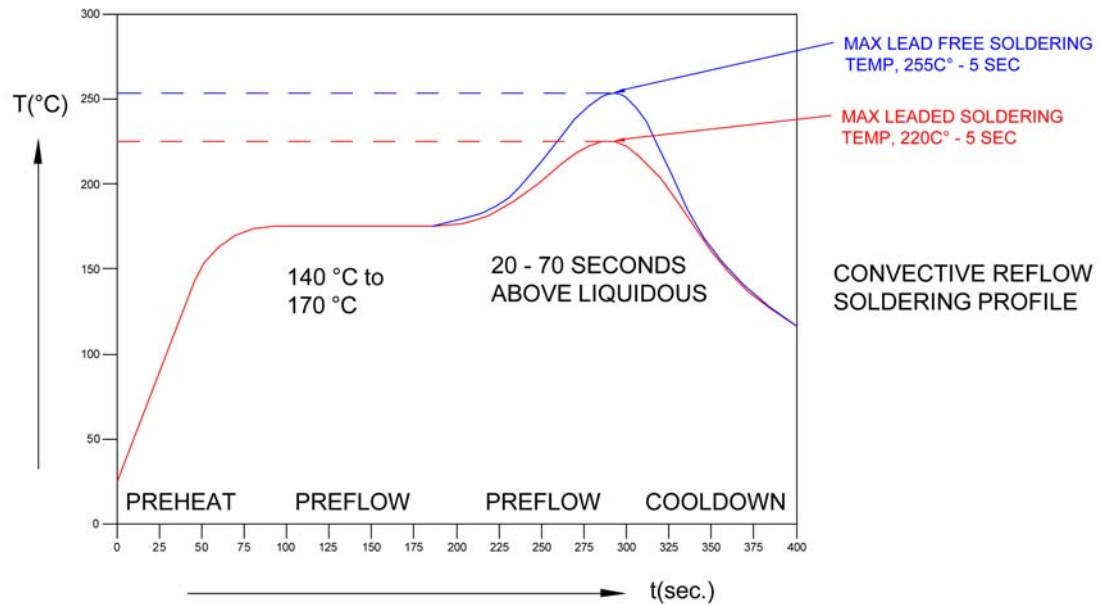

Tape and Reel Dimensions

Note: 2000 pcs/Reel

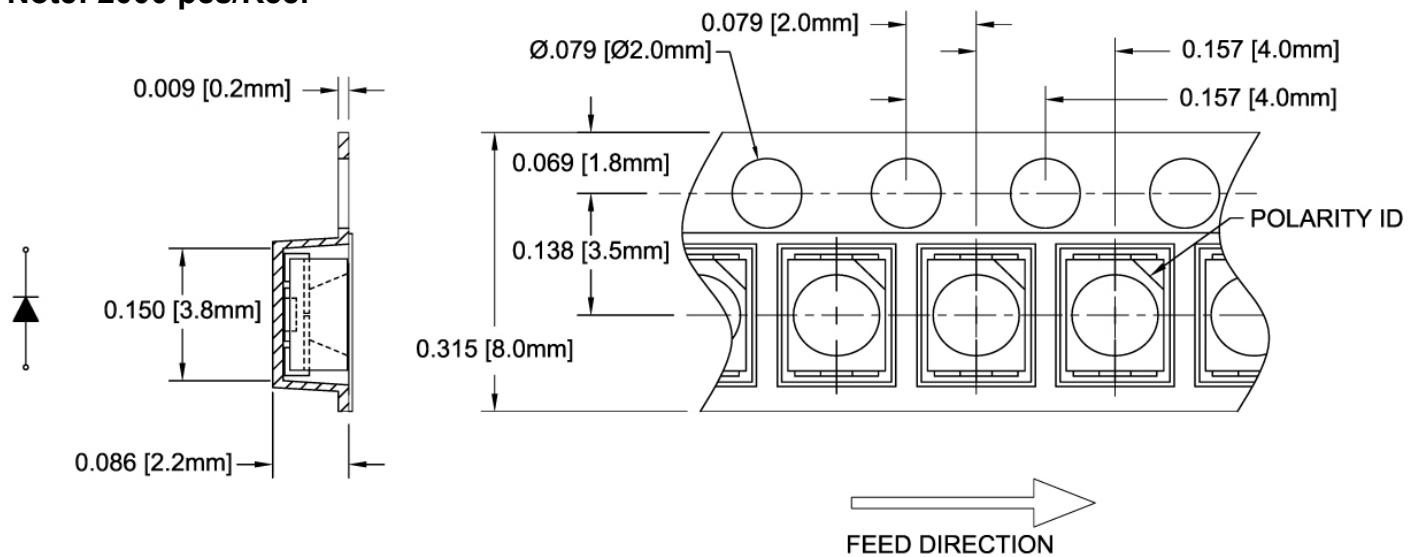

Outline Drawings Notes:
 1. All dimensions are in inches [millimeters].
 2. Standard tolerance: $\pm 0.010''$ unless otherwise noted.

Bivar reserves the right to make changes at any time without notice.

PLCC2 SMD Top View Package LED SMTL2-OC, ORANGE



Outline Drawings Notes:

1. All dimensions are in inches [millimeters].
2. Standard tolerance unless otherwise noted: X.XXX ± 0.010"
X.X ± 0.1"

Packaging and Labeling Plan

Note: 1 Reel / Bag

Sealed ESD and Moisture Barrier Bag



Humidity Indicator Card

Desiccant

Part No.	XXXX-XXX-XXX
Prod. No.	XXXX-XXX-XXX
PO No.	XXXX
Lot No.	XXXXXXXXXX
Q'ty:	X.XXX PCS
Q.C.	XXX BIN
Date:	2008.XX.XX

Internal Quality Control Label



Bivar Standard Packaging Label

Bivar reserves the right to make changes at any time without notice.