

# Features

- Wide 4:1 input voltage range
- 1.6kVDC isolation
- UL certified
- Efficiency up to 91%
- Six-sided continuous shield
- No minimum load required

# Regulated Converter



## RP30-FW

30 Watt

2" x 1"

Single and Dual Output



### Description

The RP30-FW series DC/DC converters are designed to meet to UL 60950-1 and to cUL 60950-1. This makes them ideal for all telecom and industrial applications where approved safety standards are required. The industry standard 2" x 1" package meets military standards for thermal shock and vibration tolerance.

### Selection Guide

Part Number	Input Voltage Range [VDC]	Output Voltage [VDC]	Output Current [mA]	Input <sup>(1)</sup> Current [mA]	Efficiency <sup>(1)</sup> typ. [%]	Max. Capacitive Load <sup>(2)</sup> [μF]
RP30-243.3SFW <sup>(3,4)</sup>	9-36	3.3	7500	1199	86	20000
RP30-2405SFW <sup>(3,4)</sup>	9-36	5	6000	1420	88	14400
RP30-2412SFW <sup>(3,4)</sup>	9-36	12	2500	1404	89	3000
RP30-2415SFW <sup>(3,4)</sup>	9-36	15	2000	1404	89	2000
RP30-483.3SFW <sup>(3,4)</sup>	18-75	3.3	7500	600	86	20000
RP30-4805SFW <sup>(3,4)</sup>	18-75	5	6000	710	88	14400
RP30-4812SFW <sup>(3,4)</sup>	18-75	12	2500	694	90	3000
RP30-4815SFW <sup>(3,4)</sup>	18-75	15	2000	687	91	2000
RP30-2405DFW <sup>(3,4)</sup>	9-36	±5	±3000	1420	88	±3000
RP30-2412DFW <sup>(3,4)</sup>	9-36	±12	±1250	1437	87	±2000
RP30-2415DFW <sup>(3,4)</sup>	9-36	±15	±1000	1437	87	±1300
RP30-4805DFW <sup>(3,4)</sup>	18-75	±5	±3000	710	88	±3000
RP30-4812DFW <sup>(3,4)</sup>	18-75	±12	±1250	710	88	±2000
RP30-4815DFW <sup>(3,4)</sup>	18-75	±15	±1000	710	88	±1300



### Notes:

- Note1: Maximum values at nominal input voltage and full load  
 Note2: Max. Cap load is tested at minimum input and constant resistive load

UL60950-1 certified  
 EN55032 compliant

### Model Numbering

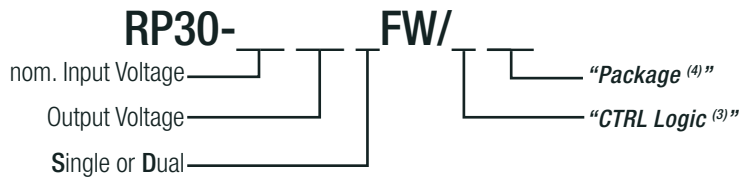

### Notes:

- Note3: no suffix for CTRL function with positive logic (1=ON, 0=OFF)  
 add suffix "N" for CTRL function with negative logic (0=ON, 1=OFF)  
 Note4: add suffix "-HC" for premounted Heat-sink with clips

### Ordering Examples

- RP30-2405SFW = 24V input, 5V output, single, positive Logic CTRL pin  
 RP30-4812DFW/N-HC = 48V input, ±12V output, dual, negative Logic CTRL pin, Heat-sink premounted

**Specifications** (measured @ Ta= 25°C, nom. Vin, full load unless otherwise stated)

### BASIC CHARACTERISTICS

Parameter	Condition		Min.	Typ.	Max.
Input Filter			Pi-Type		
Input Voltage Range	nom. Vin = 24VDC nom. Vin = 48VDC		9VDC 18VDC	24VDC 48VDC	36VDC 75VDC
Input Surge Voltage	100ms max.	nom. Vin = 24VDC nom. Vin = 48VDC			50VDC 100VDC
Under Voltage Lockout (UVLO)	nom. Vin = 24VDC	DC-DC ON DC-DC OFF		8VDC	9VDC
	nom. Vin = 48VDC	DC-DC ON DC-DC OFF		16VDC	18VDC
Output Voltage Trimming	refer to <b>"OUTPUT VOLTAGE TRIMMING"</b>		-10%		+10%
Input Reflected Ripple Current <sup>(5)</sup>				20mA <sub>p-p</sub>	
Minimum Load			0%		
Start-up Time	Power up ON/OFF CTRL			30ms 30ms	
ON/OFF CTRL <sup>(6)</sup>	Positive Logic	DC-DC ON DC-DC OFF	Open or 3.0VDC < V <sub>CTRL</sub> < 12VDC Short or 0VDC < V <sub>CTRL</sub> < 1.2VDC		
	Negative Logic	DC-DC ON DC-DC OFF	Short or 0VDC < V <sub>CTRL</sub> < 1.2VDC Open or 3.0VDC < V <sub>CTRL</sub> < 12VDC		
Input Current of CTRL pin	DC-DC ON		-0.5mA		+0.5mA
Standby Current	DC-DC OFF			3mA	
Internal Operating Frequency			387kHz	430kHz	473kHz
Ripple and Noise	measured at 20MHz BW with a 1µF/50V MLCC	3.3V <sub>out</sub> , 5V <sub>out</sub> 12V <sub>out</sub> , 15V <sub>out</sub>		100mV <sub>p-p</sub> 150mV <sub>p-p</sub>	

**Notes:**

Note5: Simulated source impedance of 12µH. 12µH inductor in series with +Vin

Note6: The ON/OFF control function can be positive or negative logic. The pin voltage is referenced to -Vin pin

### RP30-2405FW

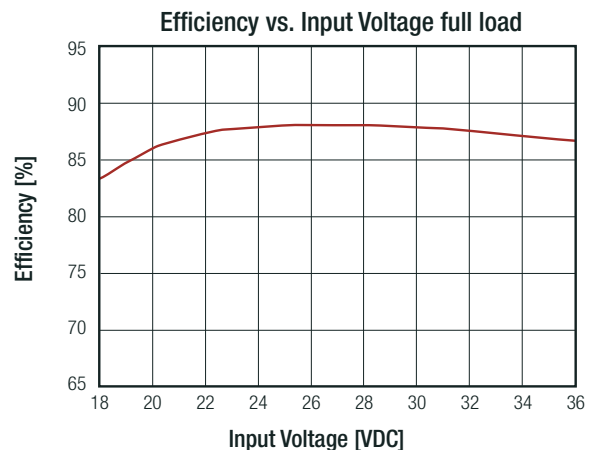
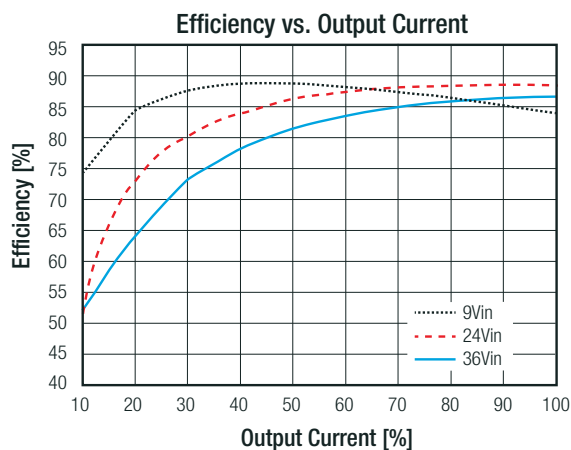

continued on next page

**Specifications** (measured @ Ta= 25°C, nom. Vin, full load unless otherwise stated)

**RP30-4805SFw**

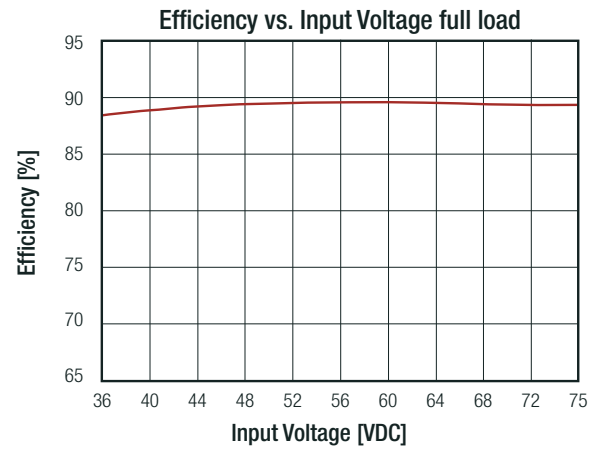
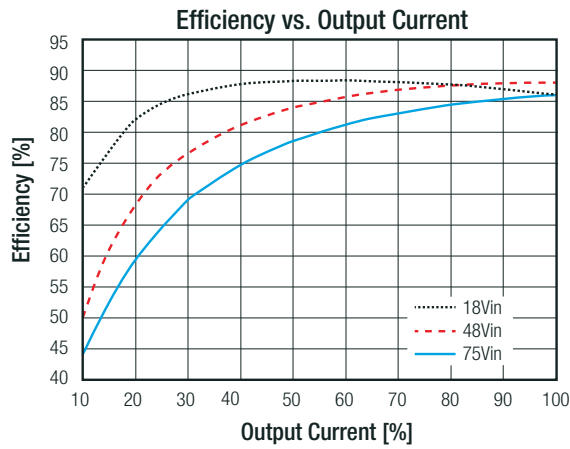

**OUTPUT VOLTAGE TRIMMING**

**Output Voltage Trimming**

Single output Powerline converters offer the feature of trimming the output voltage over a certain range around the nominal value by using external trim resistors. No general equation can be given for calculating the trim resistors, but the following trimtables give typical values for choosing these trimming resistors. If voltages between the given trim points are required, extrapolate between the two nearest given values to work out the resistor required or use a variable resistor to set the output voltage. Output can be externally trimmed by using the method shown below.

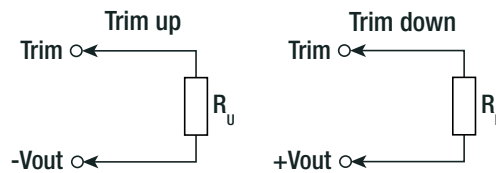

**RP30-xx3.3SFw**

Trim up	1	2	3	4	5	6	7	8	9	10	[%]
Vout =	3.333	3.366	3.399	3.432	3.465	3.498	3.531	3.564	3.597	3.63	[VDC]
Ru =	57.93	26.16	15.58	10.28	7.11	4.99	3.48	2.34	1.46	0.75	[kΩ]

Trim down	1	2	3	4	5	6	7	8	9	10	[%]
Vout =	3.267	3.234	3.201	3.168	3.135	3.102	3.069	3.036	3.003	2.97	[VDC]
Rd =	69.47	31.23	18.49	12.12	8.29	5.74	3.92	2.56	1.50	0.65	[kΩ]

**RP30-xx05SFw**

Trim up	1	2	3	4	5	6	7	8	9	10	[%]
Vout =	5.05	5.01	5.15	5.20	5.25	5.30	5.35	5.4	5.45	5.50	[VDC]
Ru =	36.57	16.58	9.92	6.58	4.59	3.25	2.30	1.59	1.03	0.59	[kΩ]

Trim down	1	2	3	4	5	6	7	8	9	10	[%]
Vout =	4.95	4.90	4.85	4.80	4.75	4.70	4.65	4.60	4.55	4.50	[VDC]
Rd =	45.53	20.61	12.31	8.15	5.66	4.00	2.81	1.92	1.23	0.68	[kΩ]

continued on next page

**Specifications** (measured @ Ta= 25°C, nom. Vin, full load unless otherwise stated)

RP30-xx12SFW											
Trim up	1	2	3	4	5	6	7	8	9	10	[%]
Vout =	12.12	12.24	12.36	12.48	12.60	12.72	12.84	12.96	13.08	13.20	[VDC]
R <sub>u</sub> =	367.91	165.95	98.64	64.98	44.78	31.32	21.70	14.49	8.88	4.39	[kΩ]
RP30-xx15SFW											
Trim up	1	2	3	4	5	6	7	8	9	10	[%]
Vout =	15.15	15.3	15.45	15.60	15.75	15.90	16.05	16.20	16.35	16.50	[VDC]
R <sub>u</sub> =	404.18	180.59	106.06	68.80	46.44	31.53	20.88	12.90	6.69	1.72	[kΩ]
Trim down	1	2	3	4	5	6	7	8	9	10	[%]
Vout =	11.88	11.76	11.64	11.52	11.40	11.28	11.16	11.04	10.92	10.8	[VDC]
R <sub>d</sub> =	460.99	207.95	123.60	81.42	56.12	39.25	27.20	18.16	11.13	5.51	[kΩ]

REGULATIONS		
Parameter	Condition	Value
Output Accuracy		±1.0% max.
Line Regulation	low line to high line, full load	±0.2% max.
Load Regulation	0% to 100% load Single Dual	±0.5% ±1.0%
Cross Regulation	asymmetrical 25%<>100% load	±5.0%
Transient Response Recovery Time	25% load step change	250µs typ.

PROTECTIONS		
Parameter	Condition	Value
Short Circuit Protection (SCP)		continuous, automatic recovery
Over Voltage Protection (OVP)	zener diode clamp 3.3Vout 5Vout 12Vout 15Vout	3.9VDC 6.2VDC 15VDC 18VDC
Over Load Protection (OLP)	% Iout rated	150% typ.
Over Temperature Protection (OTP)		115°C typ.
Isolation Voltage <sup>(7)</sup>	I/P to O/P I/P to O/P to case	1.6kVDC/ 1 minute 1.6kVDC/ 1 minute
Isolation Resistance	Viso= 500VDC	1GΩ min.
Isolation Capacitance		1500pF max.
<b>Notes:</b>		
Note7: For repeat Hi-Pot testing, reduce the time and/or the test voltage		
Note8: This power module is not internally fused. An input line fuse must always be used		

**Specifications** (measured @ Ta= 25°C, nom. Vin, full load unless otherwise stated)

**ENVIRONMENTAL**

Parameter	Condition		Value
Operating Temperature Range	without derating		-40°C to +62°C
	with derating		-40°C to +101°C
Maximum Case Temperature			+105°C max.
Temperature Coefficient			±0.02%/K max.
Thermal Impedance	@ natural convection	without heat-sink	12K/W
	0.1m/s	with heat-sink	10K/W
Operating Humidity	non-condensing		5% - 95% RH
Thermal Shock			according to MIL-STD-810F
Vibration			according to MIL-STD-810F
MTBF	MIL-HDBK-217F, G.B.		1288 x 10 <sup>3</sup> hours
	Bellcore TR-NWT-000332 <sup>(9)</sup>		3163 x 10 <sup>3</sup> hours

**Derating Graph <sup>(10)</sup>**

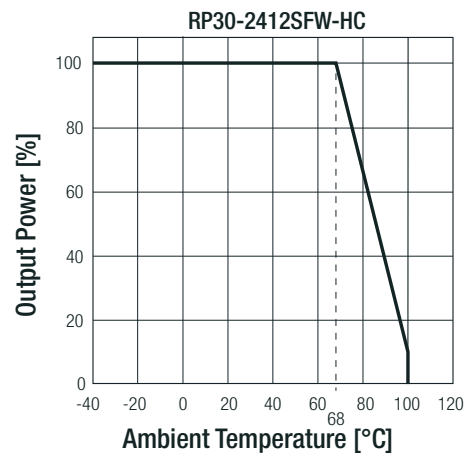
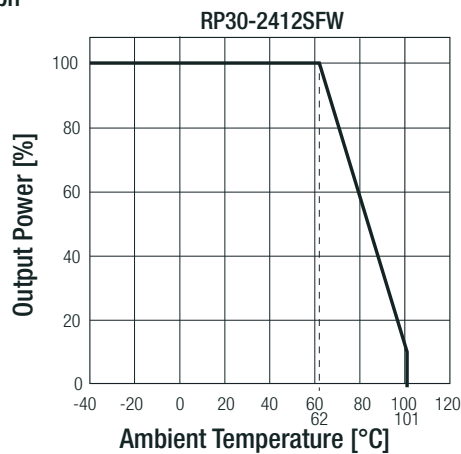

**Notes:**

Note9: BELLCORE TR-NWT-000332. Case I: 50% Stress, Temperature at 40°C (Ground fixed and controlled environment)  
MIL-HDBK-217F, G.B. Notice2 @ TA= 25°C, Full load (Ground, Benign, controlled environment)

Note10: Derating graphs are valid only for the shown part numbers. If you need detailed derating-information about a part-number not shown here please contact RECOM Techsupport for detailed information

**SAFETY AND CERTIFICATIONS**

Certificate Type (Safety)	Condition	Standard
Information Technology Equipment, General Requirements for Safety	E196683	UL60950-1, 2nd Edition 2011 CAN/CSA-C22.2 No. 60950-1, 2nd Edition 2011
EAC	RU-AT.49.09571	TP TC 004/2011
RoHS2		RoHS-2011/65/EU + AM-2015/863

EMC Compliance	Condition	Standard / Criterion
Electromagnetic compatibility of multimedia equipment - Emission requirements	with external filter (see filter suggestion below)	EN55032, Class A and B
Information technology equipment - Immunity characteristics - Limits and methods of measurement		EN55024:2010 + A1:2015
ESD Electrostatic discharge immunity test	Air ±8kV and Contact ±6kV	IEC61000-4-2:2008, Criteria A
Radiated, radio-frequency, electromagnetic field immunity test	10 V/m	IEC61000-4-3:2006 + A2:2010, Criteria A
Fast Transient and Burst Immunity <sup>(11)</sup>	±2kV	IEC61000-4-4:2012, Criteria A
Surge Immunity <sup>(11)</sup>	±1kV	IEC61000-4-5:2005, Criteria A
Immunity to conducted disturbances, induced by radio-frequency fields	10 Vr.m.s	IEC61000-4-6:2008, Criteria A

continued on next page

### Specifications (measured @ Ta= 25°C, nom. Vin, full load unless otherwise stated)

#### Notes:

Note11: An external input filter capacitor is required if the module has to meet EN61000-4-4, EN61000-4-5  
 Recom suggests Nippon chemi-con KY series 24Vin=330µF/50V or 48Vin=220µF/100V

#### EMC Filtering Suggestions according to EN55032

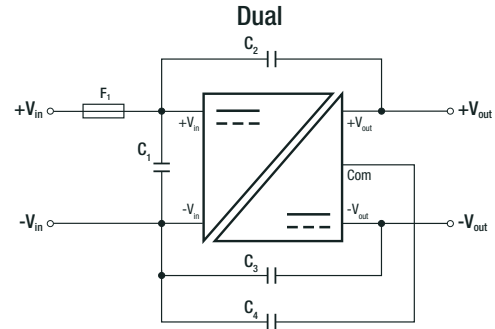
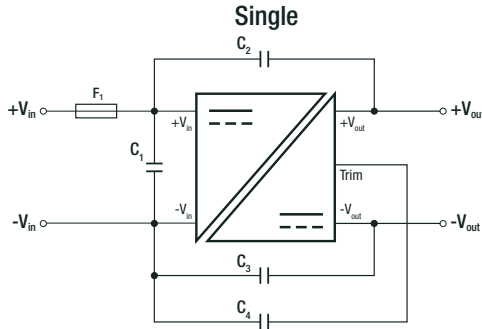

#### Component List Class A

MODEL	C1	C2	C3/C4
RP30-24xxSFW	4.7µF/50V	1000pF/2kV	1000pF/2kV
RP30-24xxDFW	1812 MLCC	1808 MLCC	1808 MLCC
RP30-48xxSFW	2.2µF/100V	1000pF/2kV	1000pF/2kV
RP30-48xxDFW	1812 MLCC	1808 MLCC	1808 MLCC

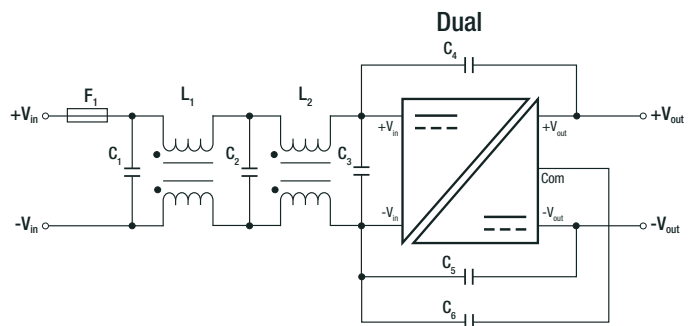
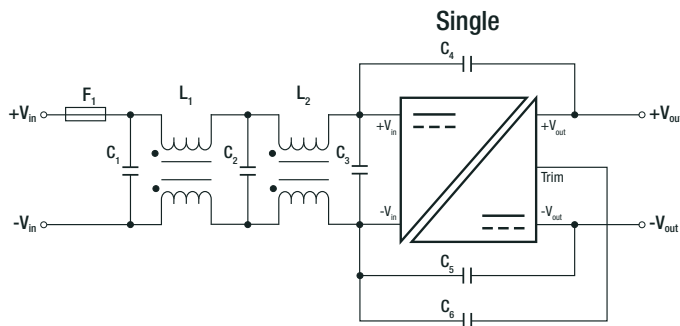

#### Component List Class B

MODEL	C1/C2/C3	C4/C5/C6	L1	L2
RP30-24xxSFW	4.7µF/50V	1000pF/2kV	CMC: 33.3µH	CMC: 55µH
RP30-24xxDFW	1812 MLCC	1808 MLCC	ref.: WE 744842932 ref.: CMC-09	ref.: WE 744290560 ref.: CMC-10
RP30-48xxSFW	2.2µF/100V	1000pF/2kV	CMC: 33.3µH	CMC: 55µH
RP30-48xxDFW	1812 MLCC	1808 MLCC	ref.: WE 744842932 ref.: CMC-09	ref.: WE 744290560 ref.: CMC-10

#### DIMENSIONS and PHYSICAL CHARACTERISTICS

Parameter	Type	Value
Material	case	nickel coated copper
	base	FR4 PCB
	potting	epoxy (UL94V-0)
Dimensions (LxWxH)	without Heat-sink	50.8 x 25.4 x 10.2mm
	with Heat-sink	56.8 x 25.4 x 16.8mm
Weight	without Heat-sink	30.5g
	with Heat-sink	41.39g

continued on next page

Specifications (measured @ Ta= 25°C, nom. Vin, full load unless otherwise stated)

### Dimension Drawing (mm)

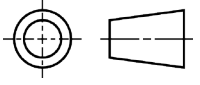
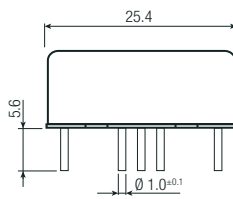
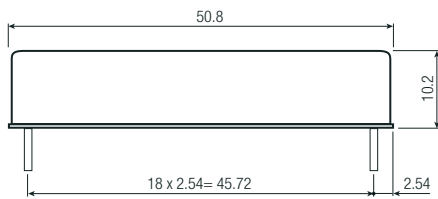

### Pinning Information

Pin #	Single	Dual
1	+Vin	+Vin
2	-Vin	-Vin
3	CTRL <sup>(3)</sup>	CTRL <sup>(3)</sup>
4	+Vout	+Vout
5	-Vout	Com
6	Trim	-Vout

Tolerance: xx.x= ±0.5mm  
xx.xx= ±0.25mm

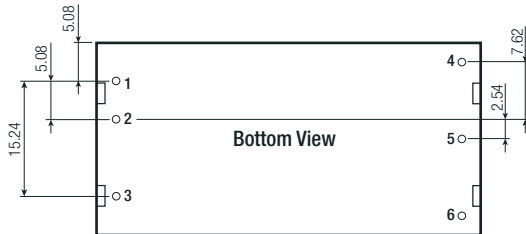

### Recommended Footprint Details

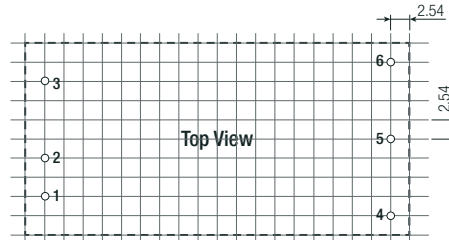

### Dimension Drawing with Heat-sink (mm)

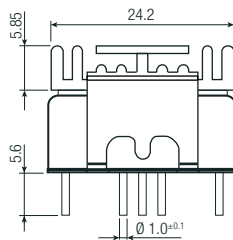
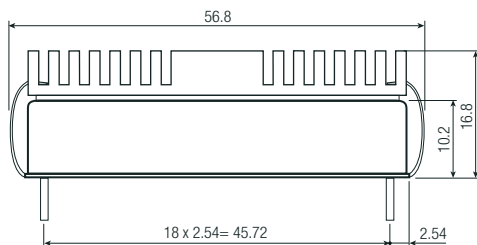
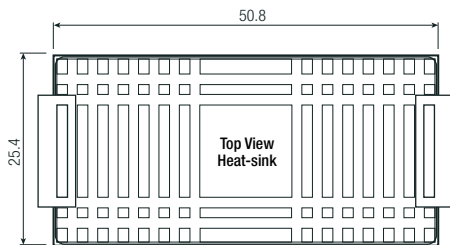

### Recommended Footprint Details

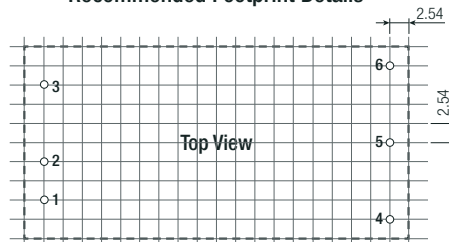
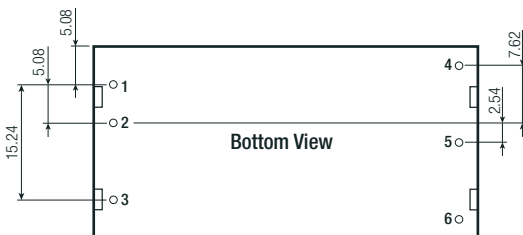

**Specifications** (measured @ Ta= 25°C, nom. Vin, full load unless otherwise stated)

PACKAGING INFORMATION			
Parameter	Type		Value
Packaging Dimension (LxWxH)	tube	without heat-sink	255.0 x 54.0 x 22.0mm
	tray	with heat-sink	302.5 x 222.0 x 20.0mm
Packaging Quantity	tube	without heat-sink	9pcs
	tray	with heat-sink	20pcs
Storage Temperature Range			-55°C to +125°C
Storage Humidity	non-condensing		5% - 95% RH

The product information and specifications may be subject to changes even without prior written notice. The product has been designed for various applications; its suitability lies in the responsibility of each customer. The products are not authorized for use in safety-critical applications without RECOM's explicit written consent. A safety-critical application is an application where a failure may reasonably be expected to endanger or cause loss of life, inflict bodily harm or damage property. The applicant shall indemnify and hold harmless RECOM, its affiliated companies and its representatives against any damage claims in connection with the unauthorized use of RECOM products in such safety-critical applications.