

Features

- 4:1 wide input range
- 3kVAC reinforced insulation for 110Vin
2.25kVDC basic insulation for 24Vin & 48Vin
- Efficiency up to 91%
- No minimum load required
- UL60950-1, EN50155 & IEC/EN60950-1 certified

Regulated Converter

RECOM DC/DC Converter

RP180H-RW

180 Watt
Half Brick
Single Output



EN50155 certified
IEC/EN60950-1 certified
UL60950-1 certified

Description

The half-brick RP180H series DC/DC converters are designed for railway rolling stock and high voltage battery applications. Each series has three 4:1 input voltage range options to cover all input voltages from 9VDC up to 160VDC with isolated and regulated 5V to 48VDC outputs. The converters have high efficiencies and metal baseplates to permit a wide operating temperature range from -40 to +90°C (with forced air cooling). The case is fitted with threaded inserts to allow secure mounting to the PCB or bulkhead for use in high shock and vibration environments. The converters are EN50155, UL60950 and IEC/EN60950 certified. The RP180H-RW series have a three year warranty.

Selection Guide

Part Number	Input Voltage Range [VDC]	Output Voltage [VDC]	Output Current [mA]	Input ⁽¹⁾ Current [mA]	Output Power [W]	Efficiency ⁽¹⁾ typ. [%]	Max. Capacitive Load [µF]
RP180H-2405SRW	9-36	5	28000	6481	140	90	56000
RP180H-2412SRW	9-36	12	12000	6666	144	90	10000
RP180H-2415SRW	9-36	15	9500	6525	142.5	91	6300
RP180H-2424SRW	9-36	24	6000	6666	144	90	2500
RP180H-2448SRW	9-36	48	3000	6666	144	90	620
RP180H-4805SRW	16.5-75	5	30000	3434	150	91	60000
RP180H-4812SRW	16.5-75	12	13000	3571	156	91	10800
RP180H-4815SRW	16.5-75	15	10000	3434	150	91	6600
RP180H-4824SRW	16.5-75	24	6500	3571	156	91	2700
RP180H-4848SRW	16.5-75	48	3200	3516	153.5	91	660
RP180H-11005SRW	43-160	5	32000	1616	160	90	64000
RP180H-11012SRW	43-160	12	15000	1818	180	90	12500
RP180H-11015SRW	43-160	15	12000	1818	180	90	8000
RP180H-11024SRW	43-160	24	7500	1818	180	90	3100
RP180H-11048SRW	43-160	48	3800	1842	182	90	790

Notes:

Note1: Efficiency is tested by nominal Vin, full load and at 25°C

Model Numbering

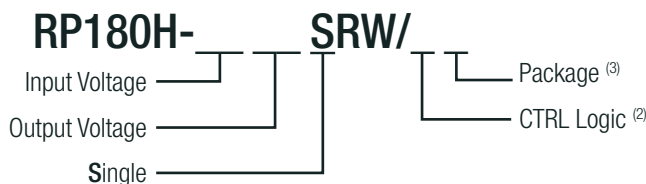

Notes:

Note2: standard part is with suffix "P" for positive logic (1=ON, 0=OFF) or add suffix "N" instead for negative logic (0=ON, 1=OFF) for more details refer to "ON/OFF CTRL (4)"

Note3: add suffix "-HC" for premounted Heat-sink (refer to "Dimension Drawing Heat-sink (mm)") (compatible with all other suffixes)

Ordering Examples

RP180H-2405SRW/N = 24V Input, 5V Output, Single, Neg. CTRL function

RP180H-11012SRW/P = 110V Input, 12V Output, Single, Pos. CTRL function

RP180H-2405SRW/N-HC = 24V Input, 5V Output, Single, Neg. CTRL function with premounted Heat-sink



<https://recom-power.com/rec-s-R-REF04-RIA12.html>



<https://recom-power.com/rec-s-RSPxxx-168.html>

Specifications (measured @Ta = 25°C, resistive load, nominal Vin and rated Iout unless otherwise noted)

BASIC CHARACTERISTICS

Parameter	Condition		Min.	Typ.	Max.
Internal Input Filter			Pi-Type		
Input Voltage Range	nom Vin = 24V nom Vin = 48V nom Vin = 110V		9VDC 16.5VDC 43VDC	24VDC 48VDC 110VDC	36VDC 75VDC 160VDC
Input Surge Voltage	Vin = 24V, 1s max. Vin = 48V, 1s max. Vin = 110V, 1s max.				50VDC 100VDC 185VDC
Under Voltage Lockout (UVLO)	Vin = 24V	DC-DC ON DC-DC OFF	7.3VDC		9VDC 8.1VDC
	Vin = 48V	DC-DC ON DC-DC OFF	15.5VDC		18VDC 16.3VDC
	Vin = 110V	DC-DC ON DC-DC OFF	33.0VDC		43VDC 36.0VDC
Quiescent Current	Vin = 24V Vin = 48V Vin = 110V		25mA 15mA	10mA	35mA 25mA
Output Voltage Trimming	refer to "OUTPUT VOLTAGE TRIMMING"		-20%		+10%
Minimum Load			0%		
Start-up time	constant resistive load	Power up, Remote ON/OFF		75ms	
ON/OFF CTRL ⁽⁴⁾ refer to "ON/OFF CTRL"	Positive Logic		DC-DC ON DC-DC OFF	Open or 3.0VDC < V _{CTRL} < 12VDC Short or 0VDC < V _{CTRL} < 1.2VDC	
	Negative Logic		DC-DC ON DC-DC OFF	Short or 0VDC < V _{CTRL} < 1.2VDC Open or 3.0VDC < V _{CTRL} < 12VDC	
Input Current of CTRL pin	drive current	I _{CTRL}	-0.5mA		1mA
Standby Current	DC-DC OFF	I _{in}		3mA	
Internal Operating Frequency			225kHz	250kHz	275kHz
Output Ripple and Noise	Measured by 20MHz BW	with a 1µF/25V X7R MLCC & a 22µF/25V POS Cap with a 1µF/25V X7R MLCC & a 22µF/25V POS Cap with a 4.7µF/50V X7R MLCC with a 2.2µF/100V X7R MLCC	5 Vout 12, 15Vout 24Vout 48Vout	75mVp-p 100mVp-p 200mVp-p 300mVp-p	
Remote Sense	% of set Vout (refer to "REMOTE SENSE")				10%

Notes:

Note4: If fitted, the ON/OFF control function can be positive or negative logic. The pin voltage is referenced to -Vin

RP180H-2405SRW

Efficiency vs. Output Current

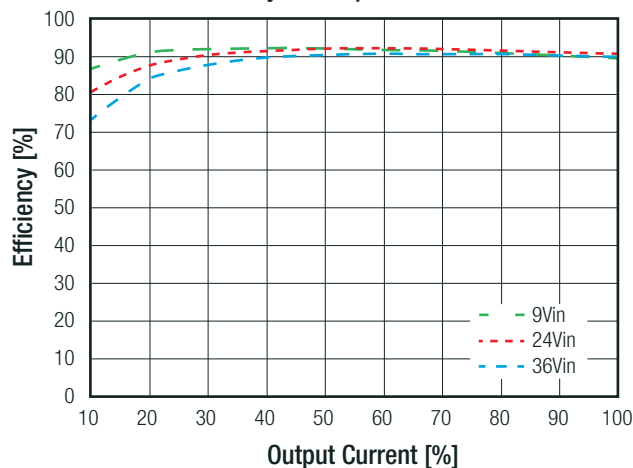

Efficiency vs. Input Voltage

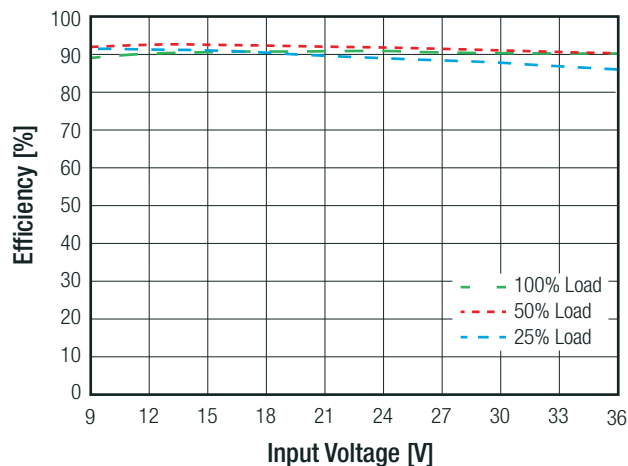

continued on next page

Specifications (measured @Ta = 25°C, resistive load, nominal Vin and rated Iout unless otherwise noted)

RP180H-2405SRW

Power Dissipation vs. Output Current

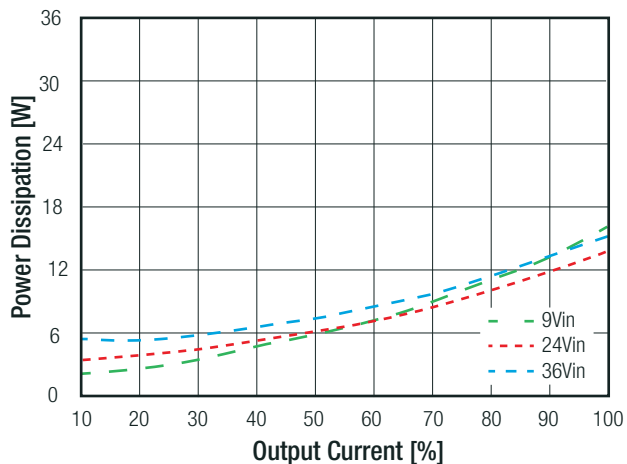

Typical Output Ripple and Noise/full load

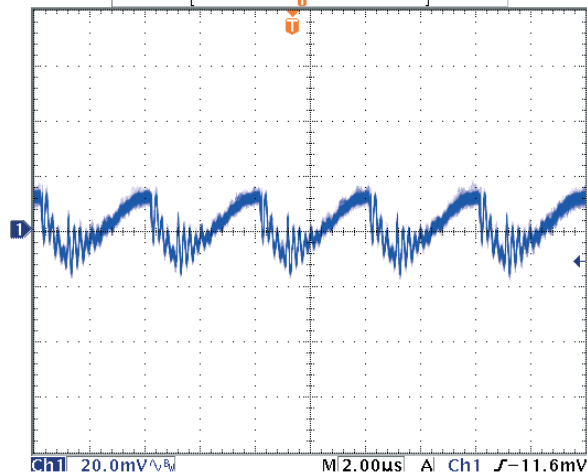

ON/OFF Control Start up Rise Characteristic

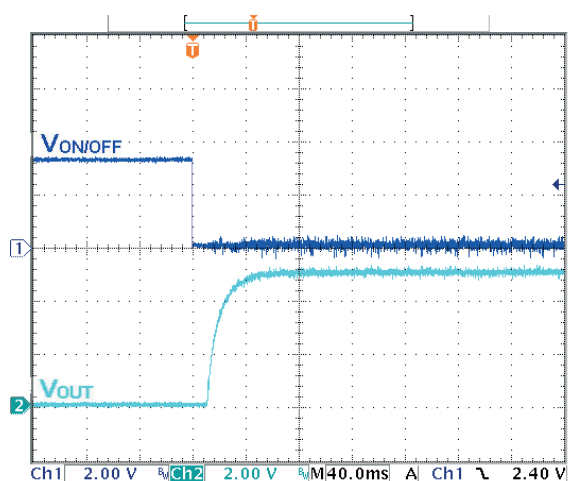

Power up Start-up Rise Characteristic

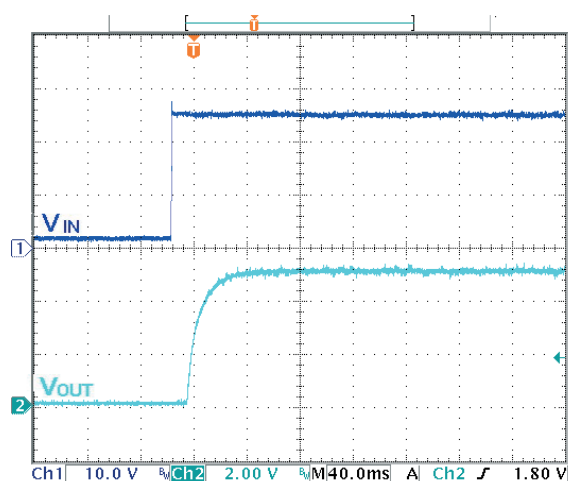

RP180H-4805SRW

Efficiency vs. Output Current

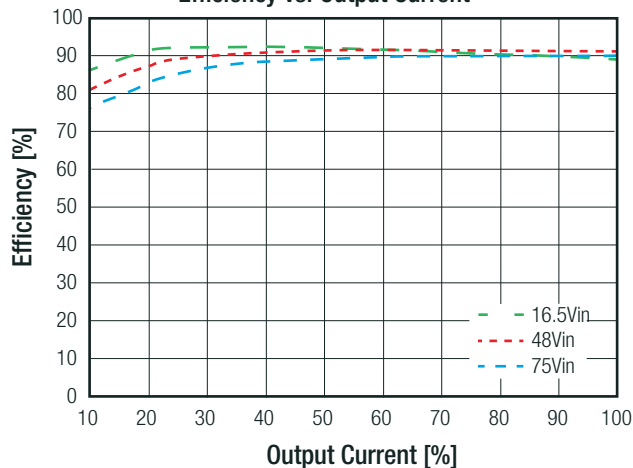

Efficiency vs. Input Voltage

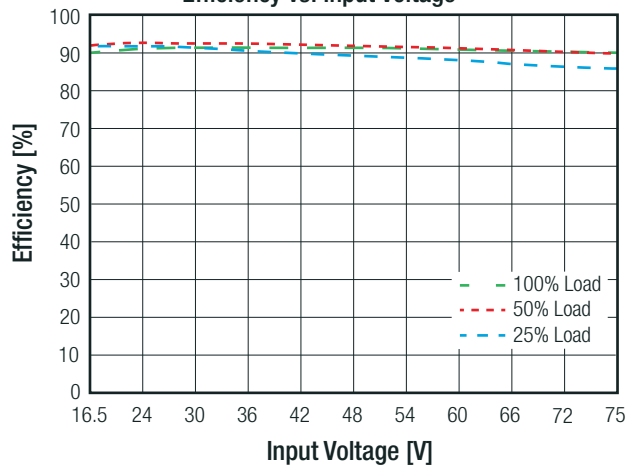

continued on next page

Specifications (measured @Ta = 25°C, resistive load, nominal Vin and rated Iout unless otherwise noted)

RP180H-4805SRW

Power Dissipation vs. Output Current

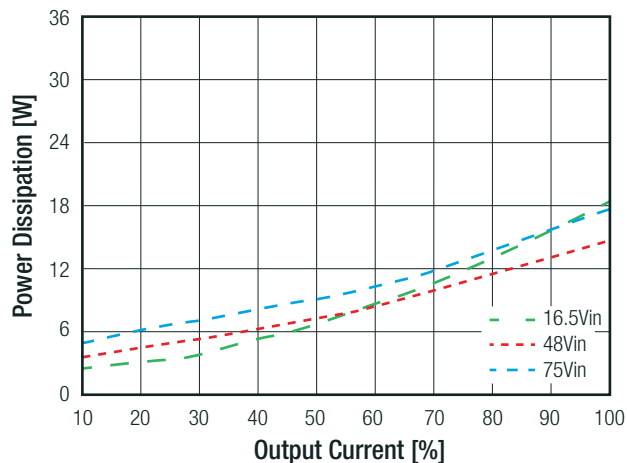

Typical Output Ripple and Noise/full load

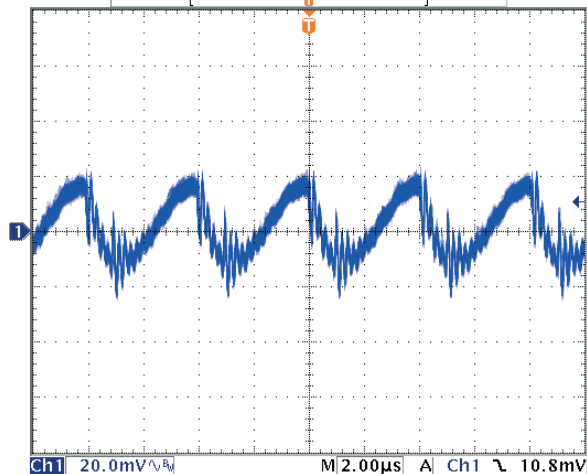

ON/OFF Control Start up Rise Characteristic

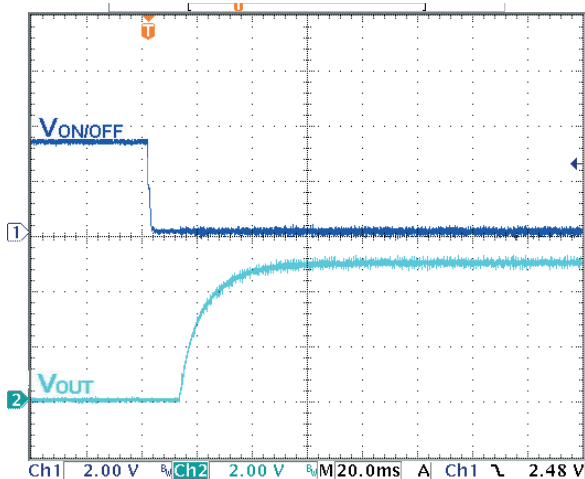

Power up Start-up Rise Characteristic

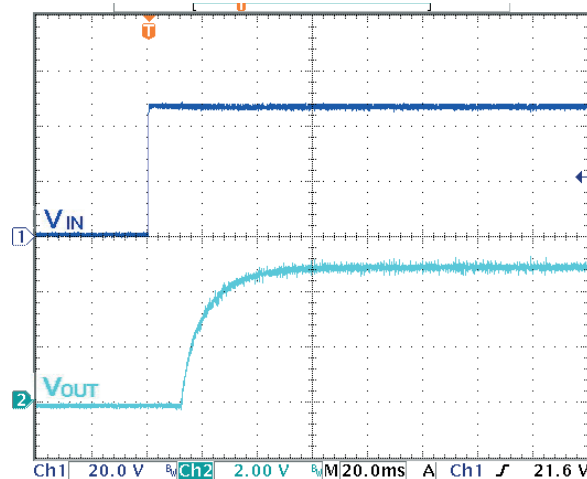

RP180H-11005SRW

Efficiency vs. Output Current

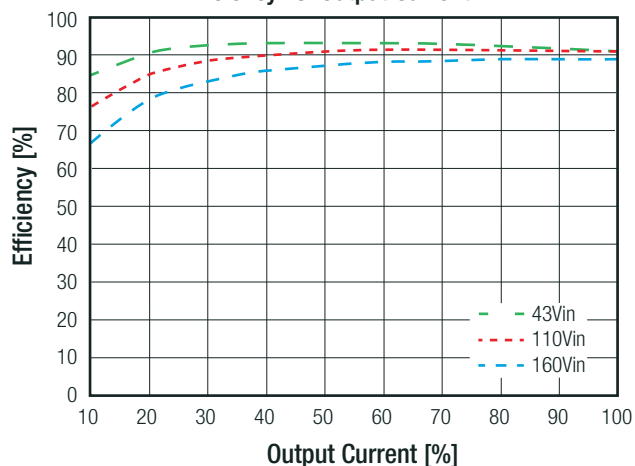

Efficiency vs. Input Voltage

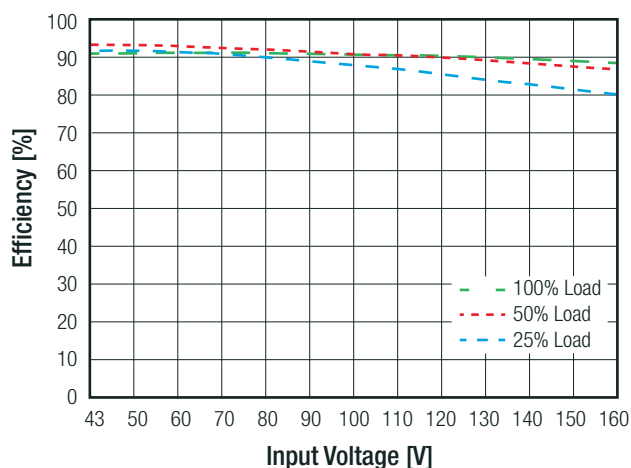

continued on next page

Specifications (measured @Ta = 25°C, resistive load, nominal Vin and rated Iout unless otherwise noted)

RP180H-11005SRW

Power Dissipation vs. Output Current

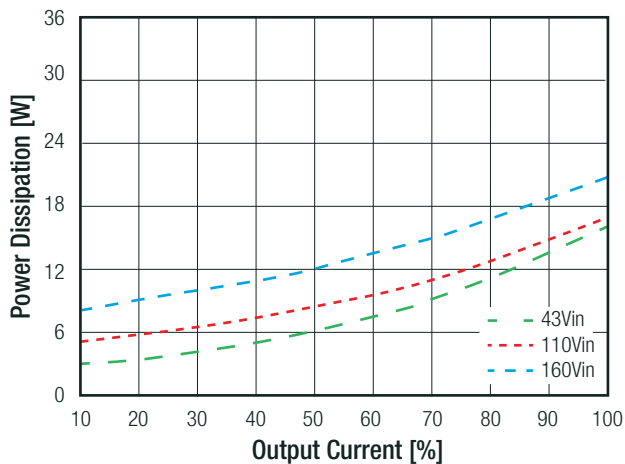

Typical Output Ripple and Noise/full load

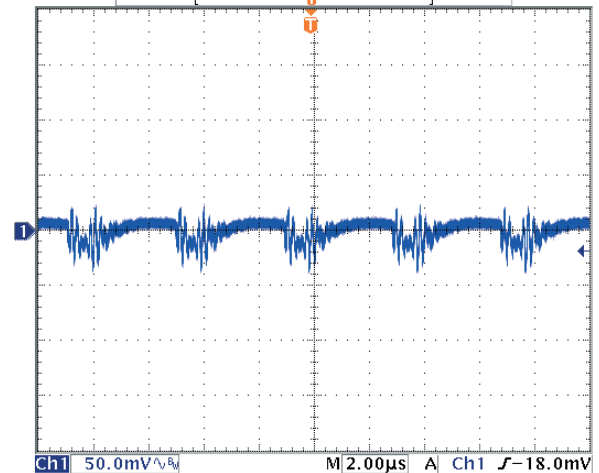

ON/OFF Control Start up Rise Characteristic

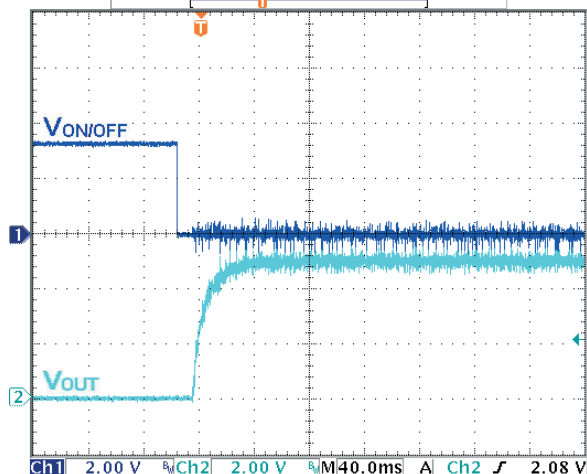

Power up Start-up Rise Characteristic

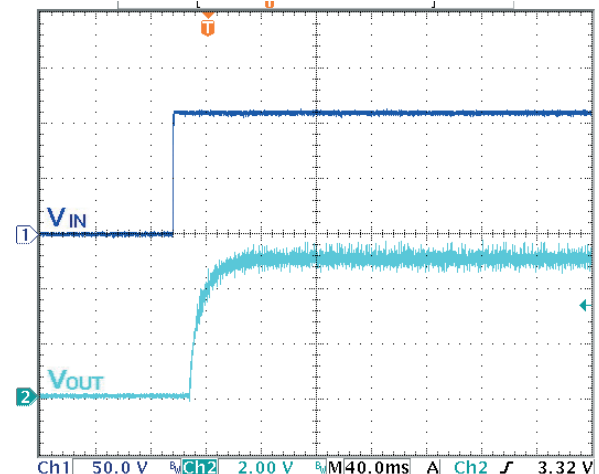

ON/OFF CTRL

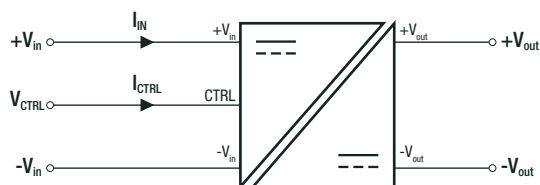

Positive Logic	DC-DC ON	Open or 3.0VDC < V _{CTRL} < 12VDC
	DC-DC OFF	Short or 0VDC < V _{CTRL} < 1.2VDC
Negative Logic	DC-DC ON	Short or 0VDC < V _{CTRL} < 1.2VDC
	DC-DC OFF	Open or 3.0VDC < V _{CTRL} < 12VDC

REMOTE SENSE

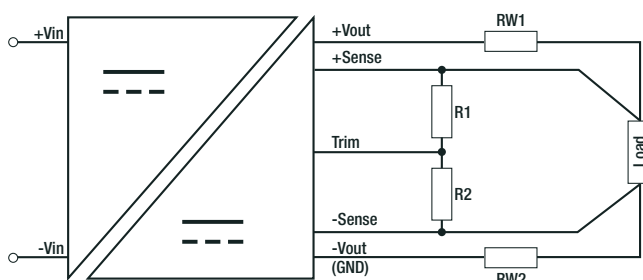

The output voltage can be adjusted by both trim and remote sense. The maximum combined adjustment range ±10%. Derate the maximum output power if using the trim or sense function.

- R_{W1} ... wire losses +
- R_{W2} ... wire losses -
- R₁ ... trim up resistor
- R₂ ... trim down resistor

OUTPUT VOLTAGE TRIMMING

Output Voltage Trimming

RP180H-RW converters offer the feature of trimming the output voltage over a certain range around the nominal value by using external trim resistors. The values for trim resistors shown in trim tables below are according to standard E96 values; therefore, the specified voltage may slightly vary; they also can be calculated with below shown equation

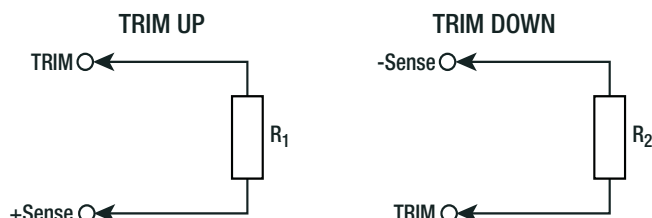

Trim Calculation

$$R_1 = \left[\frac{100 \cdot V_{out} + \Delta V_{out} \cdot V_{out}}{1.225 \cdot \Delta V_{out}} - \frac{(100 + 2 \cdot \Delta V_{out})}{\Delta V_{out}} \right] \text{ k}\Omega$$

$$R_2 = \left[\frac{100}{\Delta V_{out}} - 2 \right] \text{ k}\Omega$$

V_{out} = Output Voltage
 ΔV_{out} = Output Voltage Trim in %
 R₁ = trim up resistor
 R₂ = trim down resistor

Practical Example:

Trim Up:

V_{out} = 5V, ΔV_{out} = 10% (5.5V)

$$R_1 = \left[\frac{100 \cdot V_{out} + \Delta V_{out} \cdot V_{out}}{1.225 \cdot \Delta V_{out}} - \frac{(100 + 2 \cdot \Delta V_{out})}{\Delta V_{out}} \right] \text{ k}\Omega = \left[\frac{100 \cdot 5 + 10 \cdot 5}{1.225 \cdot 10} - \frac{100 + 2 \cdot 10}{10} \right] = 44.89 - 12 = 32.9 \text{ k}\Omega$$

Trim down:

V_{out} = 5V, ΔV_{out} = -10% (4.5V)

$$R_2 = \left[\frac{100}{\Delta V_{out}} - 2 \right] \text{ k}\Omega = \frac{100}{10} - 2 = 8.06 \text{ k}\Omega$$

RP180H-xx05SRW

Trim up	1	2	3	4	5	6	7	8	9	10	%
V _{out} =	5.05	5.10	5.15	5.20	5.25	5.30	5.35	5.4	5.45	5.50	Volts
R ₁ =	309	158	105	78.7	63.4	53.6	46.4	40.2	36.5	33.2	KOhms

RP180H-xx12SRW

Trim up	1	2	3	4	5	6	7	8	9	10	%
V _{out} =	12.12	12.24	12.36	12.48	12.60	12.72	12.84	12.96	13.08	13.20	Volts
R ₁ =	887	453	301	226	182	154	133	118	105	95.3	KOhms

RP180H-xx15SRW

Trim up	1	2	3	4	5	6	7	8	9	10	%
V _{out} =	15.15	15.30	15.45	15.60	15.75	15.90	16.05	16.20	16.35	16.50	Volts
R ₁ =	1130	576	383	294	237	196	169	150	137	124	KOhms

continued on next page

Specifications (measured @Ta = 25°C, resistive load, nominal Vin and rated Iout unless otherwise noted)

OUTPUT VOLTAGE TRIMMING

RP180H-xx24SRW											
Trim up	1	2	3	4	5	6	7	8	9	10	%
Vout =	24.24	24.48	24.72	24.96	25.20	25.44	25.68	25.92	26.16	26.40	Volts
R ₁ =	1870	953	634	487	392	332	280	249	226	205	KOhms
RP180H-xx48SRW											
Trim up	1	2	3	4	5	6	7	8	9	10	%
Vout =	48.48	48.96	49.44	49.92	50.40	50.88	51.36	51.84	52.32	52.80	Volts
R ₁ =	3830	1960	1300	1000	806	681	576	511	464	422	KOhms
Trim Down all Vout's											
Trim down	1	2	3	4	5	6	7	8	9	10	%
R ₂ =	97.6	47.5	31.6	23.2	17.8	14.7	12.1	10.5	9.09	8.06	KOhms
Trim down	11	12	13	14	15	16	17	18	19	20	%
R ₂ =	7.15	6.34	5.76	5.11	4.64	4.22	3.92	3.57	3.24	3.01	KOhms

REGULATIONS

Parameter	Condition	Value
Output Accuracy		±1.0%
Line Regulation	low line to high line at full load	±0.1%
Load Regulation	0% to 100% load	0.1%
Transient Response	25% load step change	200µs typ.; 250µs max.

Transient Response to Dynamic Load Change from 100% to 75% to 100% of full load at nom. Vin

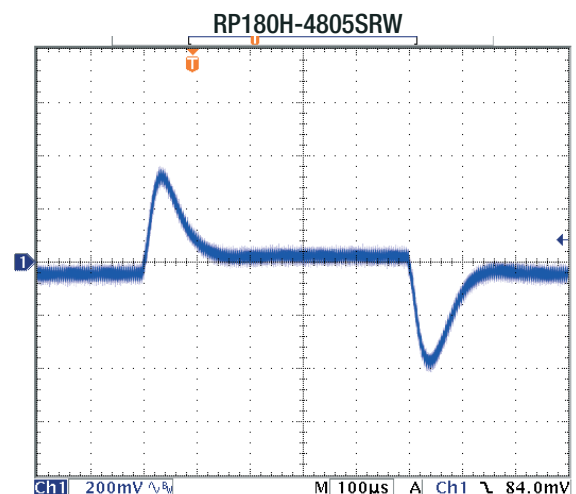
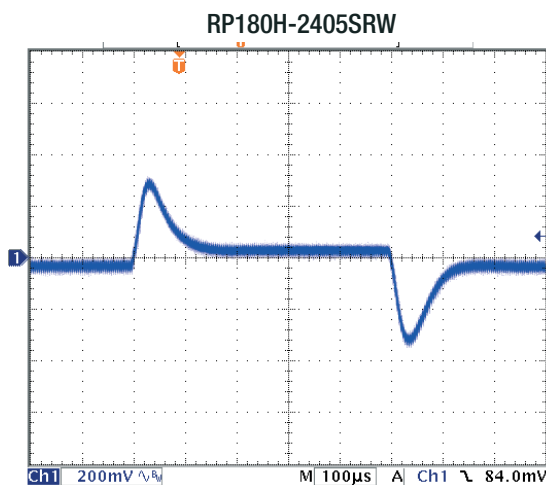

continued on next page

Specifications (measured @Ta = 25°C, resistive load, nominal Vin and rated Iout unless otherwise noted)

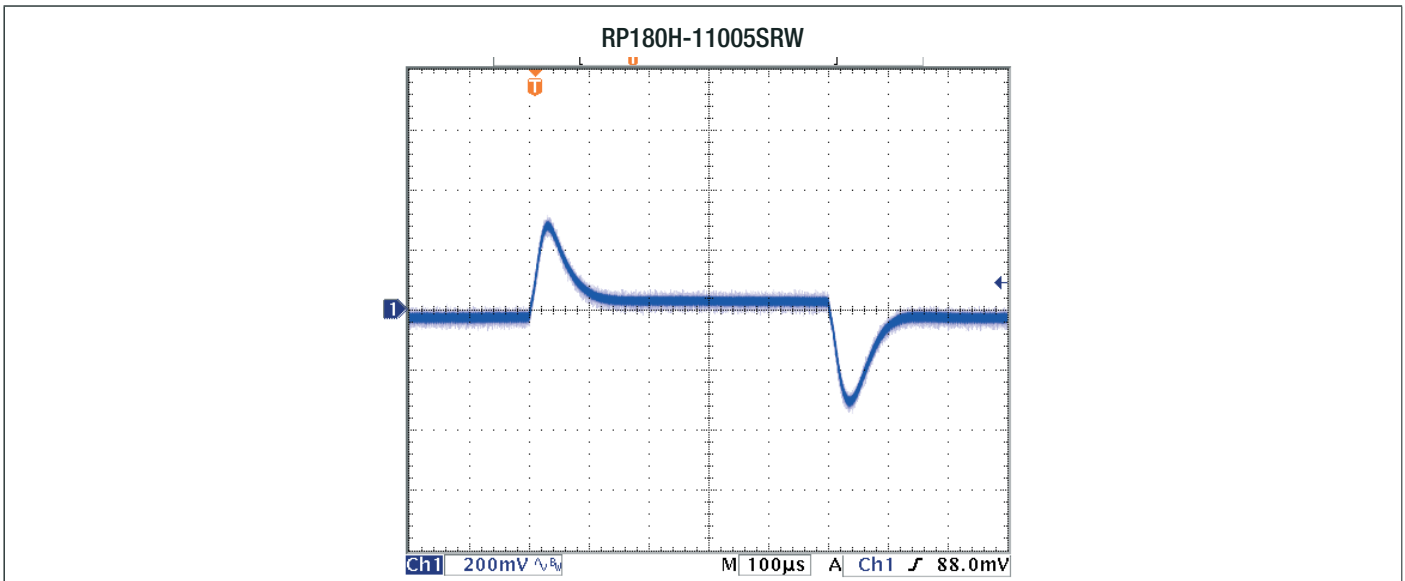

PROTECTIONS

Parameter	Condition		Value
Short Circuit Protection (SCP)	below 100mΩ		continuous, automatic recovery
Over Voltage Protection (OVP)	% of nom. Vout		115%-130%, Hiccup Mode
Over Load Protection (OLP)	% Iout rated		120%-150%, Hiccup Mode
Over Temperature Protection (OTP)			+120°C
Isolation Voltage	110Vin	I/P to O/P I/P or O/P to Baseplate	3kVAC/1minute 1.5kVAC/1minute
	24Vin, 48Vin	I/P to O/P I/P or O/P to Baseplate	2.25kVDC/1minute 1.6kVDC/1minute
Isolation Resistance	500 VDC		1GΩ min.
Isolation Capacitance			2500pF max.
Isolation Grade	110Vin		reinforced insulation
	24Vin, 48Vin		basic insulation

Notes:

Note5: Refer to local wiring regulations if input over-current protection is also required. Recommended fuse: T70A slow blow

ENVIRONMENTAL

Parameter	Condition	Value
Operating Case Temperature Range	Baseplate	refer to derating graph
Maximum Case Temperature		115°C
Temperature Coefficient		±0.02%/°C max.
Thermal Impedance	vertical direction by natural convection (0.1m/s) without Heat-sink	6.1°C/W
	vertical direction by natural convection (0.1m/s) with Heat-sink	4.6°C/W
Operating Humidity		5% - 95% RH
Pollution Degree		PD2
Shock		according to EN61373 standard
Thermal Shock		according to MIL-STD-810F standard
Vibration		according to EN61373 standard
Fire protection on railway vehicles		according to EN45545-2, 2013 standard
MTBF	according to MIL-HDBK-217F standard, 25°C	350.0 x 10 ³ hours

continued on next page

Specifications (measured @Ta = 25°C, resistive load, nominal Vin and rated Iout unless otherwise noted)

Thermal Calculation

$$R_{th\text{case-ambient}} = 6.1^{\circ}\text{C/W (vertical)}$$

$$R_{th\text{case-ambientHC}} = 4.6^{\circ}\text{C/W (vertical)}$$

$$R_{th\text{case-ambient}} = \frac{T_{\text{case}} - T_{\text{ambient}}}{P_{\text{dissipation}}}$$

$$P_{\text{dissipation}} = P_{\text{IN}} - P_{\text{OUT}} = \frac{P_{\text{OUTapp}}}{\eta} - P_{\text{OUTapp}}$$

T_{case} = Case Temperature

T_{ambient} = Environment Temperature

$P_{\text{dissipation}}$ = Internal losses

P_{IN} = Input Power

P_{OUT} = Output Power

η = Efficiency under given Operating Conditions

$R_{th\text{case-ambient}}$ = Thermal Impedance

Practical Example:

Take the RP180H-2405SRW with 9V input Voltage and 50% load. What is the maximum ambient operating temperature? Use converter vertical in application without airflow.

$$\text{Eff}_{\text{min}} = 90\% @ V_{\text{nom}}$$

$$P_{\text{OUT}} = 140\text{W}$$

$$P_{\text{OUTapp}} = 140 \times 0.5 = 70\text{W}$$

$$\eta = 91\% \text{ (Efficiency vs. Load Graph)}$$

$$P_{\text{dissipation}} = \frac{70}{0.91} - 70 = 6.92\text{W}$$

without Heat-sink

$$R_{th} = \frac{T_{\text{casemax}} - T_{\text{amb}}}{P_{\text{dissipation}}} \rightarrow 6.1^{\circ}\text{C/W} = \frac{115 - T_{\text{amb}}}{6.92\text{W}}$$

$$T_{\text{amb}} = 72^{\circ}\text{C}$$

with Heat-sink

$$R_{thHC} = \frac{T_{\text{casemax}} - T_{\text{amb}}}{P_{\text{dissipation}}} \rightarrow 4.6^{\circ}\text{C/W} = \frac{115 - T_{\text{amb}}}{6.92\text{W}}$$

$$T_{\text{ambHC}} = 83^{\circ}\text{C}$$

Derating Graph⁽⁶⁾

(@ Chamber - tested with forced convection)

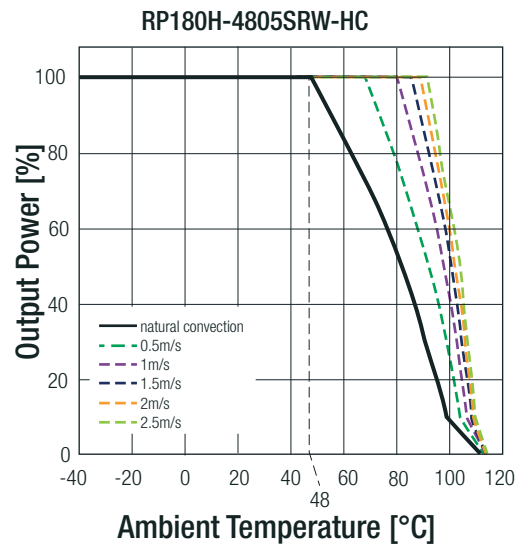
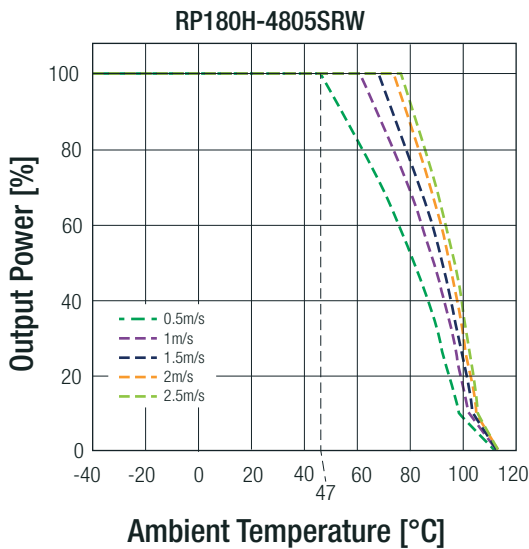
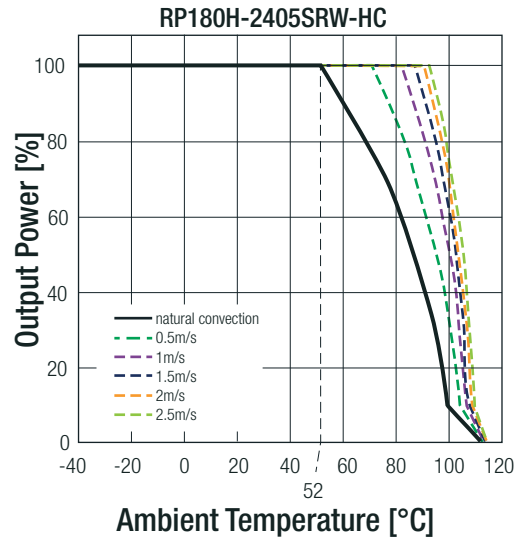
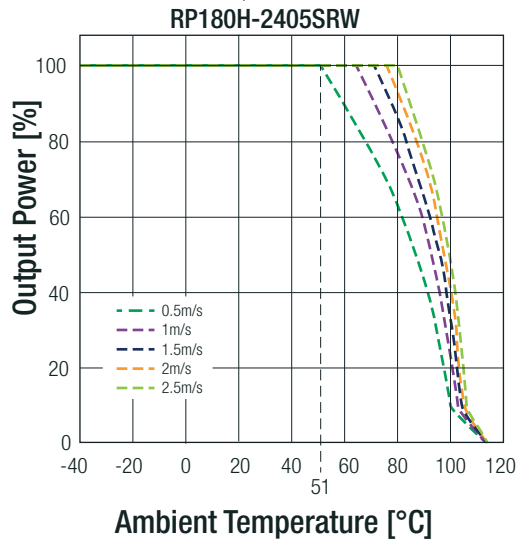

continued on next page

Specifications (measured @Ta = 25°C, resistive load, nominal Vin and rated Iout unless otherwise noted)

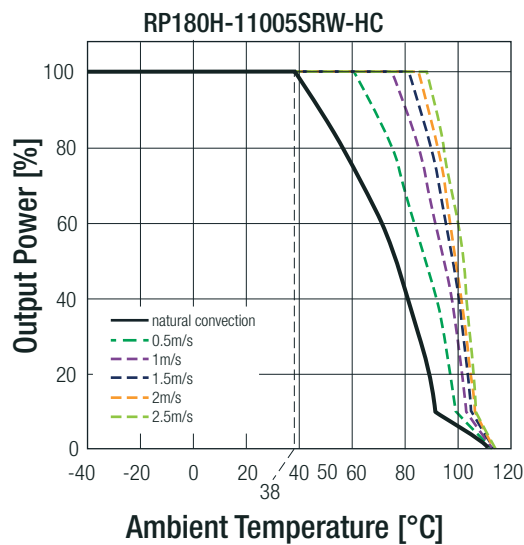
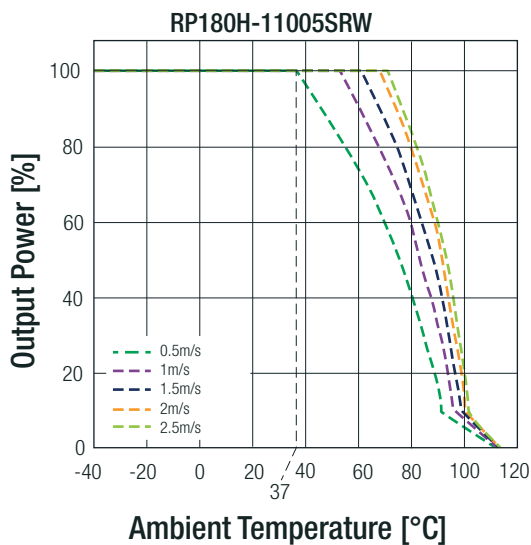

Notes:

Note6: Derating graphs are valid only for the shown part numbers. If you need detailed derating-information about a part-number not shown here please contact our technical support service at techsupportAT@recom-power.com

SAFETY AND CERTIFICATIONS

Certificate Type (Safety)	Report / File Number	Standard
Information Technology Equipment, General Requirements for Safety	E196683	UL60950-1, 2nd Edition, 2014 CSA C22.2 No. 60950-1-07, 2nd Edition, 2014
Information Technology Equipment - General Requirements for Safety	TW1608033-001, TW1608036-001, TW1608037-001	IEC60950-1, 2nd Edition, 2005 EN60950-1, 2006
Railway Applications - Electrical Equipment used on rolling stock	16A081501E-C	EN50155, 2007
EAC	RU-AT.49.09571	TP TC 004/2011
RoHS2+		RoHS 2011/65/EU
EMI Compliance	Condition	Standard / Criterion
Information technology equipment - Radio disturbance characteristics - Limits and methods of measurement	with external components	EN55032, Class A and Class B
Industrial, scientific and medical equipment - Radio frequency disturbance characteristics - Limits and methods of measurement		EN55011, Class A and Class B
ESD Electrostatic discharge immunity test	Air ±8kV and Contact ±6kV	EN61000-4-2, Criteria A
Radiated, radio-frequency, electromagnetic field immunity test	20 V/m	EN61000-4-3, Criteria A
Fast Transient and Burst Immunity ⁽⁷⁾	±2kV	EN61000-4-4, Criteria A
Surge Immunity ⁽⁷⁾	±2kV	EN61000-4-5, Criteria A
Immunity to conducted disturbances, induced by radio-frequency fields	10 Vr.m.s	EN61000-4-6, Criteria A

Notes:

Note7: An external input filter capacitor is required if the module has to meet EN61000-4-4 and EN61000-4-5
 The **24Vin** and **48Vin** version recommend 2pcs of aluminium electrolytic capacitor to connect in parallel
 Recom suggest: Nippon Chemi-con KY series, 220µF/100V.
 The **110Vin** version recommend 3pcs of aluminium electrolytic capacitor to connect in parallel
 Recom suggest: Rubycon BXF series, 100µF/250V

continued on next page

Specifications (measured @Ta = 25°C, resistive load, nominal Vin and rated Iout unless otherwise noted)

EMI Filtering according to EN55032/11 Class A and EN50121-1

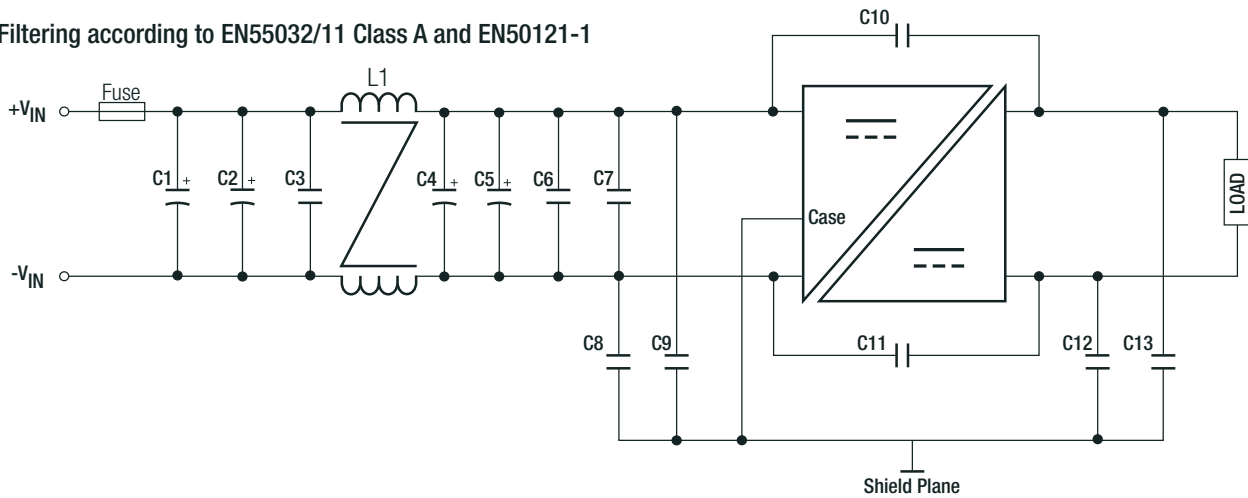

MODEL	C1, C2, C4, C5	C3, C6, C7	C8, C9, C10, C11, C13	C12	L1
RP180H-24xxSRW	470µF, 50V Al cap. (lie down) Chemi-con KY	4.7µF, 50V 1812 MLCC	1000pF, 3kV 1808 MLCC	3300pF, 3kV 1808 MLCC	156µH CMC
RP180H-48xxSRW	220µF, 100V Al cap. (lie down) Chemi-con KY	2.2µF, 100V 1812 MLCC		1000pF, 3kV 1808 MLCC	224µH CMC
RP180H-110xxSRW	150µF, 200V Al cap. (lie down) Chemi-con KXJ	1µF, 250V 1812 MLCC		1000pF, 3kV 1808 MLCC	521µH CMC

RP180H-2405SRW

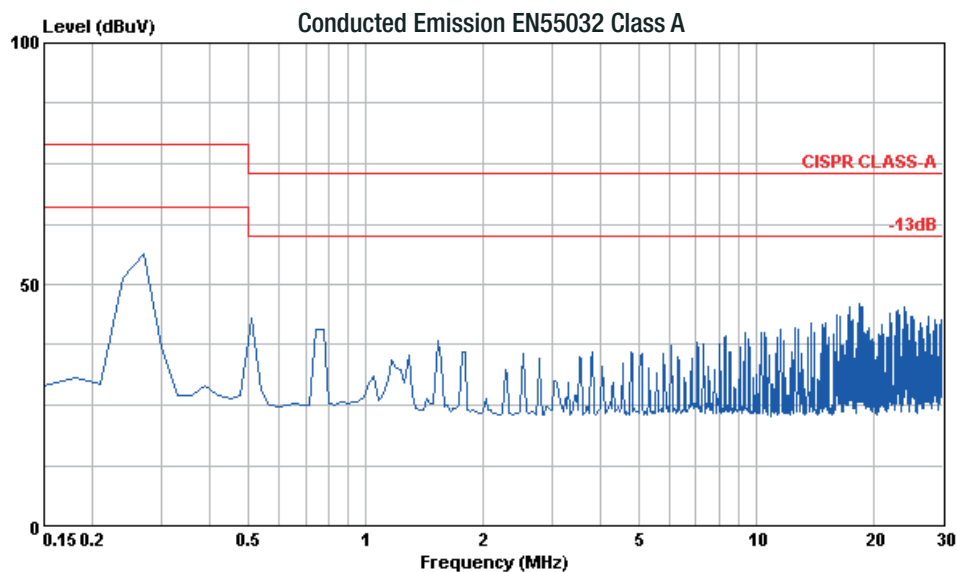

continued on next page

Specifications (measured @Ta = 25°C, resistive load, nominal Vin and rated Iout unless otherwise noted)

RP180H-4805SRW

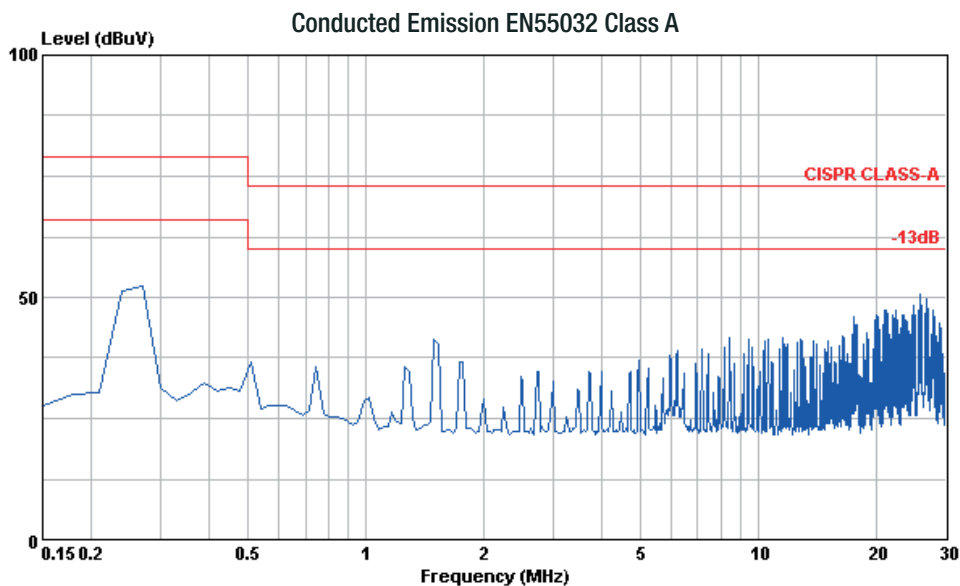

RP180H-11005SRW

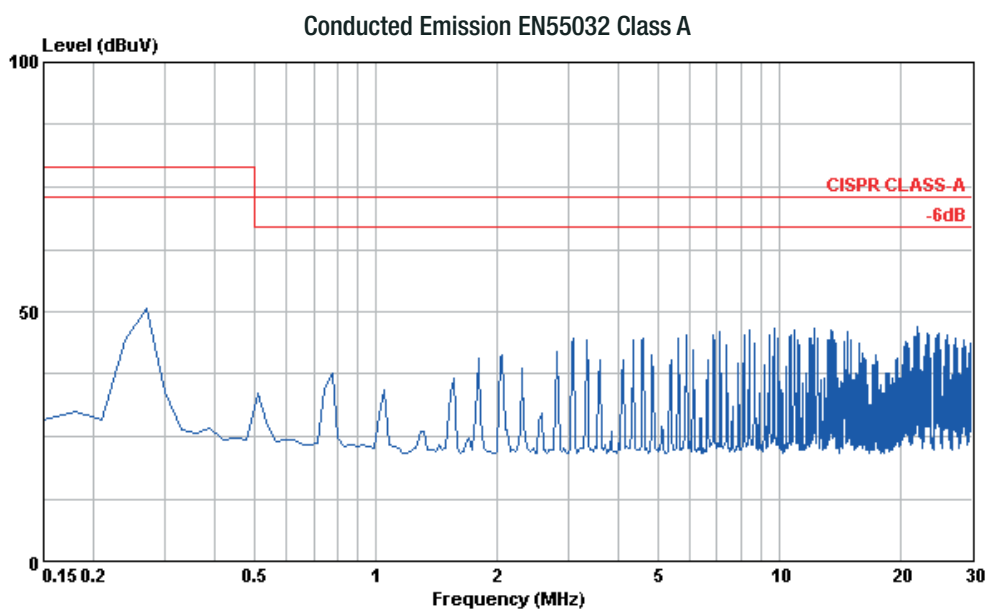

continued on next page

Specifications (measured @Ta = 25°C, resistive load, nominal Vin and rated Iout unless otherwise noted)

EMI Filtering according to EN55032/11 Class B

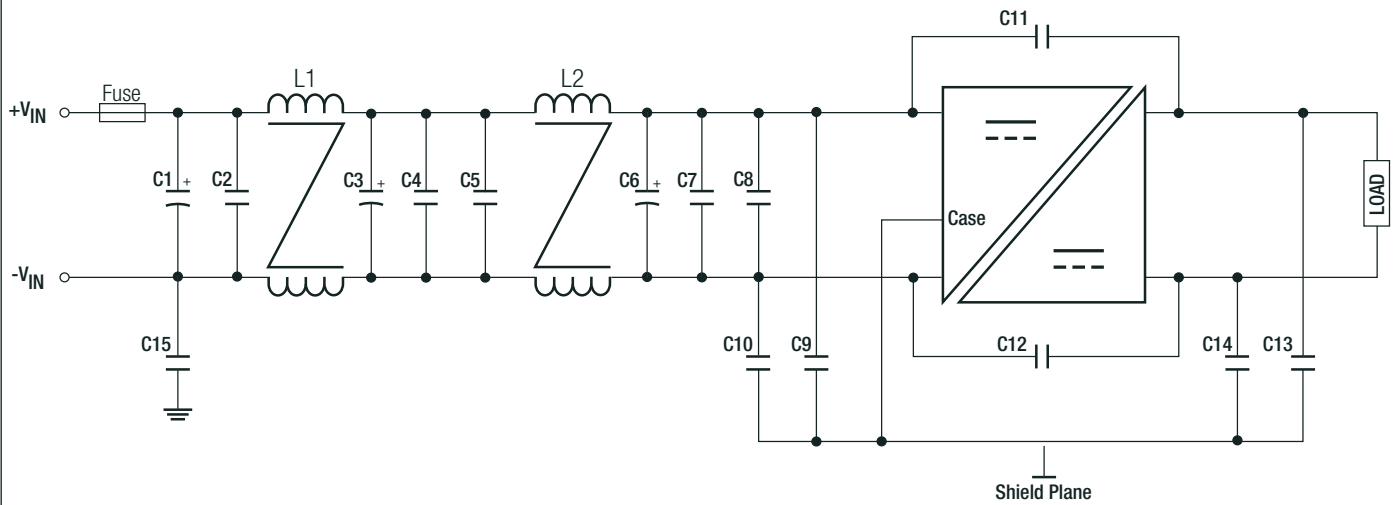

MODEL	C1, C3, C6	C2, C4, C5, C7, C8	C9, C10	C11	C12	C13, C14	C15	L1, L2
RP180H-24xxSRW	470µF, 50V Al cap. (lie down) Chemi-con KY	4.7µF, 50V 1812 MLCC	10nF, 2kV 1812 MLCC	1000pF, 3kV 1808 MLCC	4700pF, 3kV 1812 MLCC	10nF, 2kV 1812 MLCC	N/A	156µH CMC
RP180H-48xxSRW	220µF, 100V Al cap. (lie down) Chemi-con KY	2.2µF, 100V 1812 MLCC	10nF, 2kV 1812 MLCC	2200pF, 3kV 1808 MLCC	2200pF, 3kV 1812 MLCC	10nF, 2kV 1812 MLCC	1000pF, 3kV 1808 MLCC	224µH CMC
RP180H-110xxSRW	150µF, 200V Al cap. (lie down) Chemi-con KXJ	1µF, 250V 1812 MLCC	2200pF, 3kV 1808 MLCC	2200pF, 3kV 1808 MLCC	2200pF, 3kV 1808 MLCC	1000pF, 3kV 1808 MLCC	1000pF, 3kV 1808 MLCC	521µH CMC

RP180H-2405SRW

Conducted Emission EN55032 Class B

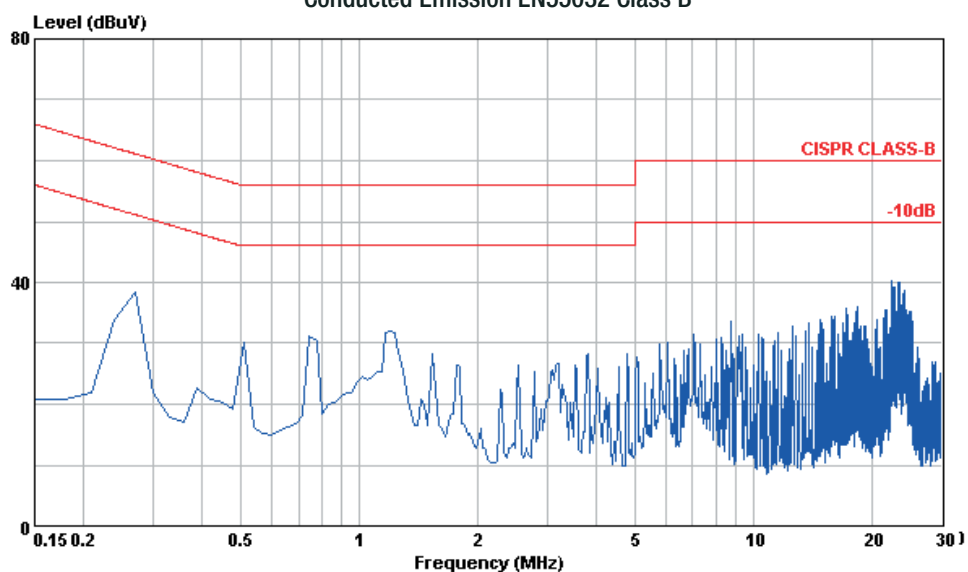

continued on next page

Specifications (measured @Ta = 25°C, resistive load, nominal Vin and rated Iout unless otherwise noted)

RP180H-4805SRW

Conducted Emission EN55032 Class B

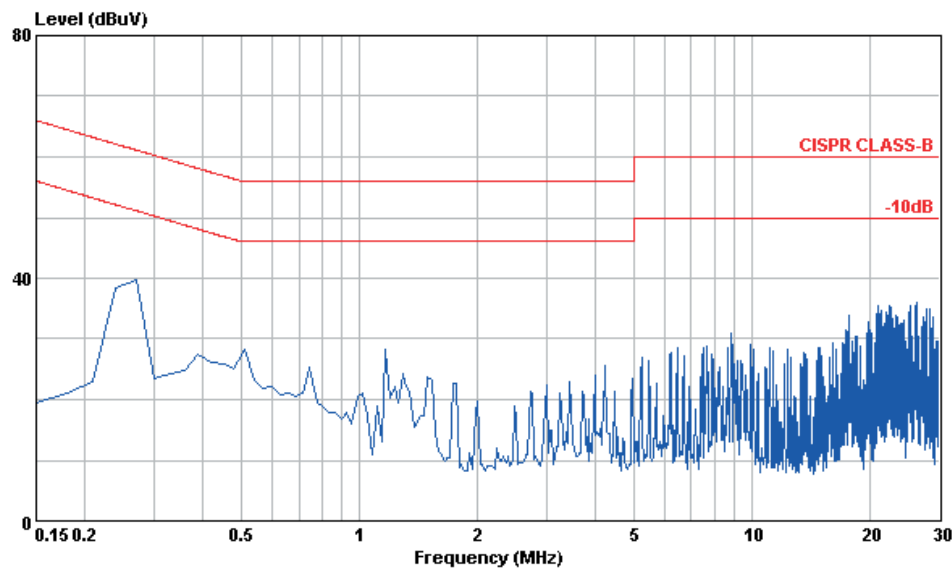

RP180H-11005SRW

Conducted Emission EN55032 Class B

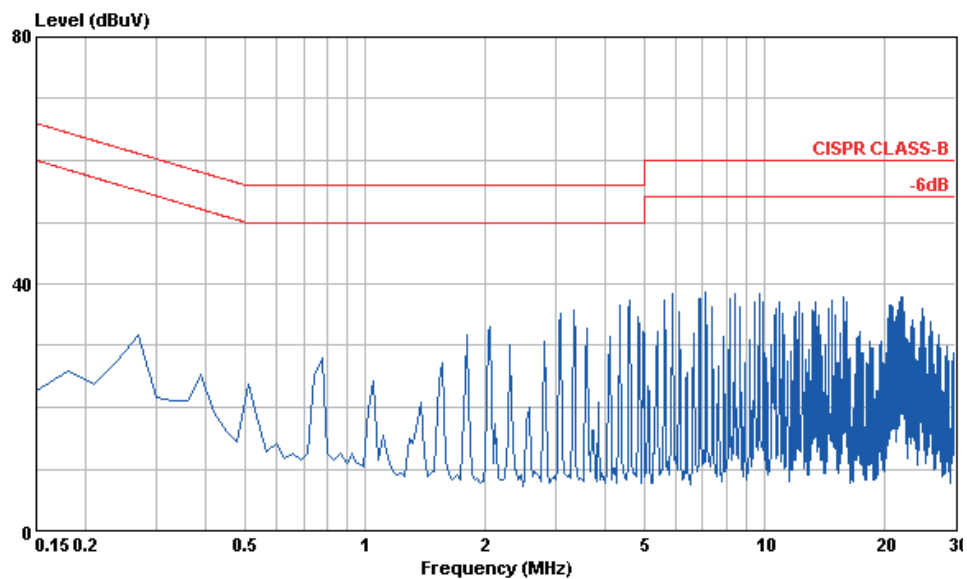

DIMENSIONS and PHYSICAL CHARACTERISTICS

Parameter	Type		Value
Material	case	24Vin, 48Vin 110Vin	Metal Plastic
	baseplate	110Vin	Aluminium
	potting		Silicone (UL94 V-0)
Dimensions (LxWxH)	without Heat-sink with Heat-sink		61.0 x 57.9 x 12.7mm 61.0 x 57.9 x 24.13mm
Weight	without Heat-sink with Heat-sink		105g 157g

continued on next page

Specifications (measured @Ta = 25°C, resistive load, nominal Vin and rated Iout unless otherwise noted)

Dimension Drawing (mm)

24Vin, 48Vin

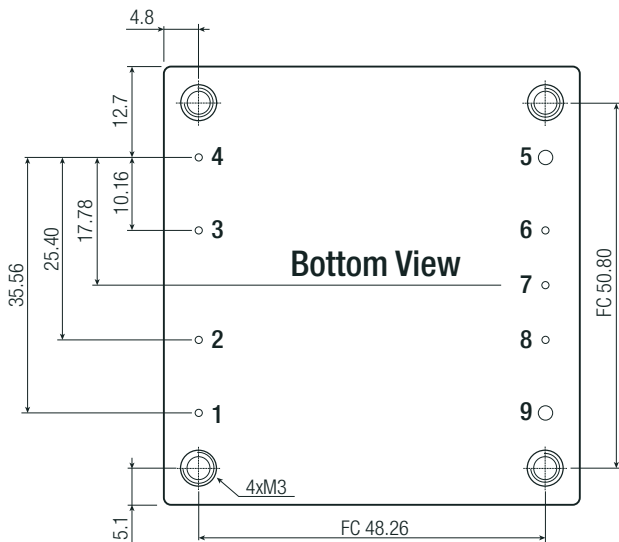
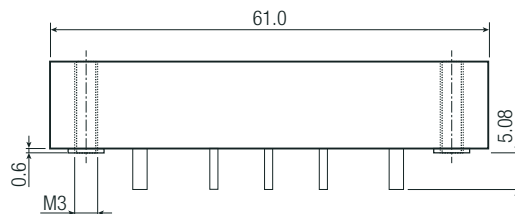
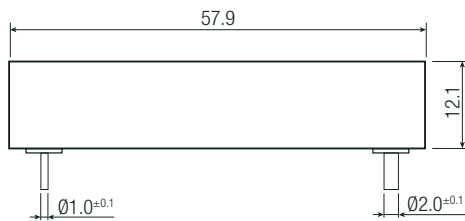
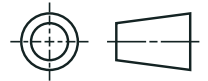

Pin Connections

Pin #	Single
1	+Vin
2	CTRL
3	Case
4	-Vin
5	-Vout
6	-Sense
7	Trim
8	+Sense
9	+Vout

FC= Fixing Centers for Heat-sink
 Pin Pitch Tolerance ±0.25mm
 Pin Dimension Tolerance ±0.1mm
 XX.X ± 0.5mm
 XX.XX ± 0.25mm

110Vin

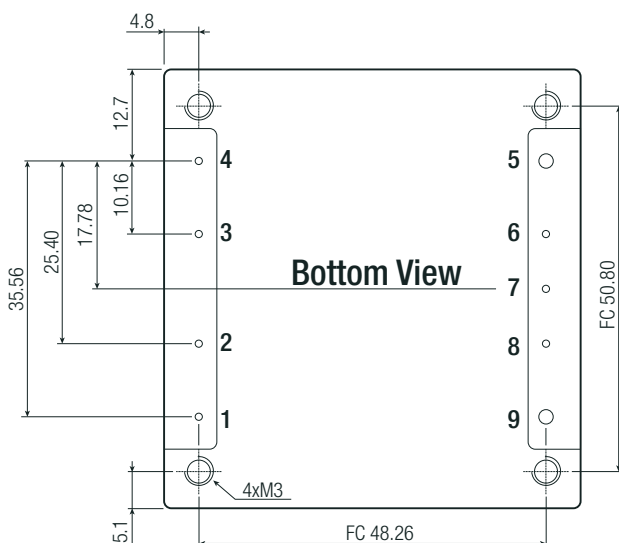
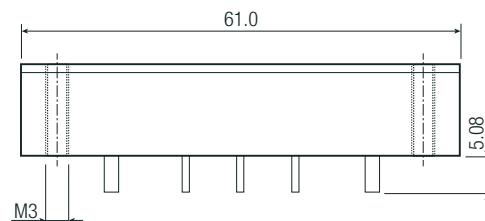
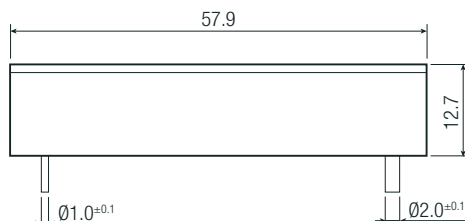

Pin Connections

Pin #	Single
1	+Vin
2	CTRL
3	Case
4	-Vin
5	-Vout
6	-Sense
7	Trim
8	+Sense
9	+Vout

FC= Fixing Centers for Heat-sink
 Pin Pitch Tolerance ±0.25mm
 Pin Dimension Tolerance ±0.1mm
 XX.X ± 0.5mm
 XX.XX ± 0.25mm

continued on next page

Specifications (measured @Ta = 25°C, resistive load, nominal Vin and rated Iout unless otherwise noted)

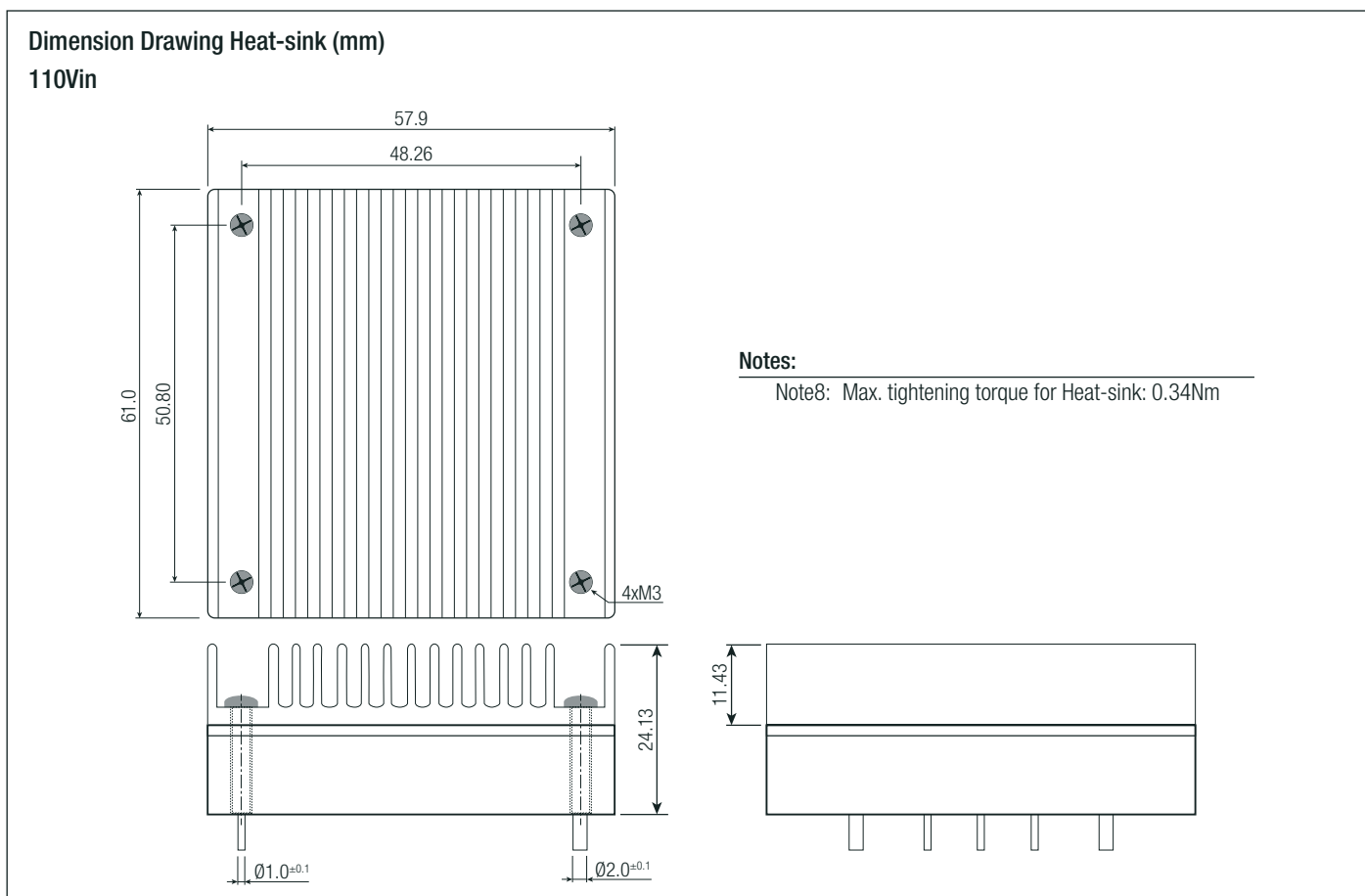

PACKAGING INFORMATION			
Parameter	Type		Value
Packaging Dimension	tray	without Heat-sink	157.0 x 88.0 x 23.0mm
		with Heat-sink	157.0 x 88.0 x 35.0mm
Packaging Quantity			2pcs.
Storage Temperature Range			-55°C to +125°C
Storage Humidity			5% - 95% RH

The product information and specifications may be subject to changes even without prior written notice. The product has been designed for various applications; its suitability lies in the responsibility of each customer. The products are not authorized for use in safety-critical applications without RECOM's explicit written consent. A safety-critical application is an application where a failure may reasonably be expected to endanger or cause loss of life, inflict bodily harm or damage property. The applicant shall indemnify and hold harmless RECOM, its affiliated companies and its representatives against any damage claims in connection with the unauthorized use of RECOM products in such safety-critical applications.