

SPECIFICATION

Part Number: **MAT.03A**

Product Name: MAT.03A Embedded Active GPS and Cellular Antenna Assembly and Reference Board

Features: 2in1 Embedded Antenna Solution
Two SMA(F) connectors for Output
GPS Antenna – ASGP.1575.25B.4.A.01

- SMT Active GPS Patch Antenna
- High performance 28dB LNA
- Ultra low power consumption
- Patch 25x25x4mm

Cellular Antenna- PA.25 Hexa-Band Cellular SMT Antenna

- 2G and 3G Bands
- GSM/GPRS/CDMA/HSPA
- High efficiency Multi-band SMT antenna
- 35x5x6mm

RoHS Compliant ✓

5.



1. Introduction

The MAT.03A Reference GPS and Cellular Embedded Antenna board combines the 2G/3G PA.25 Hexa-Band Cellular SMT Antenna and the ASGP.1575.25B.4.A.0 SMT 28dB Active GPS Patch Antenna from Taoglas. It can be used as a reference board design or actual embedded antenna for telematics applications such as fleet management, asset tracking, road pricing, and security/surveillance. Best placement for this reference board in a device would be over the existing mainboard and away from metal to allow for maximum radiated efficiency, and for the GPS antenna to get a view towards the sky.

The board comes with one SMA(F) connector for each antenna feed on the bottom side for easy connection via a cable assembly to a module or test equipment.

Cellular Antenna PA.25

This compact SMT ceramic high performance antenna achieves high efficiency on almost all worldwide 2G and 3G bands, for applications such as GSM/GPRS/CDMA/HSPA. Transmission losses are kept to absolute minimum resulting in much improved over the air (OTA) device performance compared to similar efficiency cable and connector antenna solutions.

GPS Antenna ASGP.1575.25B.4.A.01

The patent pending revolutionary SMT GPS patch antenna allows for optimal GPS performance by combining the ceramic patch, SAW, LNA, and feed pad in one integral sandwich package, mounted on its own ground-plane. Having the SAW filter and LNA right after the feed reduces the chance of noise entering the transmission line and boosts the GPS signal at the source before noise enters, allowing for better signal to noise ratio.

It also frees up space on your board traditionally used for the filter and LNA.

The SAW is placed in front of the LNA, helping to prevent saturation due to nearby radio transmitters, and the possibility of radiated spurious emissions through other radio systems.

Individual specifications on the antennas are available on the Taoglas website. Contact your regional Taoglas office for support on integration of these antennas in your own device such as gerber and layout review, and matching.

2. Specification

2.1 System Configuration

This antenna specification covers the Hexa-band Cellular Full band and GPS (L1 Band).

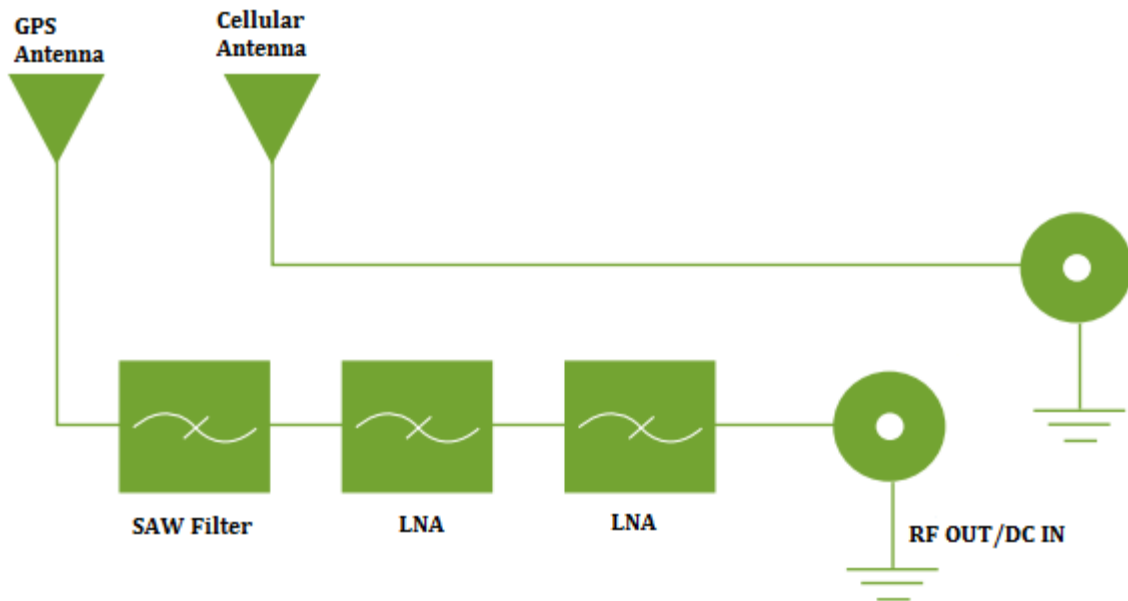

Figure 1. System configuration

2.2 PA.25 Cellular Antenna

Electrical*				
	824-960 MHz	1710-1880MHz	1850-1990MHz	1920-2170MHz
Peak Gain (dBi)	0.48	2.13	2.54	2.25
Efficiency (%)	51.41	57.79	53.27	48.34
Return loss	<-5 dB			
Impedance	50Ω			
Polarization	Linear			
Mechanical				
EVB Connector	SMA(F)			
Dimensions (mm)	35 x 6 x 5			
Termination	Ag (environmental-friendly Pb free)			
Material	Ceramic			
Environmental				
Operation Temperature	-40°C to 85°C			
Storage Temperature	-40°C to 105°C			
Relative Humidity	Non-condensing 65°C 95% RH			
RoHs Compliant	Yes			

*Ground plane size 110x40 mm

2.3 ASGP.1575.25B.4.A.01 GPS Antenna

Electrical Specifications - Antenna*	
Polarization	RHCP
Axial ratio	Max 3.0dB@zenith
Input Voltage	Min:1.8V Typ.: 3.0V Max: 5.5V
Gain	Typ. -1.5dBic @ Zenith
Mechanical Specifications - Antenna	
Dimensions (mm)	25 x 25 x 4
Connection	SMT via solder pads
Environmental Specifications - Antenna	
Operation Temperature	-40°C to 85°C
Storage Temperature	-40°C to + 85°C
Relative Humidity	40% to 95%

Electrical Specifications - LNA*	
Frequency Range	1575.42 ± 1.023 MHz
Output Impedance	50Ω
Outer Band Attenuation	F0=1575.42MHz
	F0±30MHz 5dB min
	F0±50MHz 25dB min
	F0±100MHz 30dB min
Pout at 1dB Gain Compression point	-7 dBm Typ.
Output VSWR	2.0 Max

LNA Gain, Power Consumption and Noise Figure*			
Voltage	LNA Gain (Typ)	Power Consumption(mA) Typ	Noise Figure(Typ)
Min 1.8V	20dB	4.5mA	2.8dB
Typ 3.0V	28dB	9mA	2.7dB
Max 5.5V	30dB	18mA	3.0dB

Electrical Specifications – Overall*	
Frequency Range	1575.42MHz +/- 1.023 MHz
Gain	At 90° at 3.0V 26.5±4dBi
Output Impedance	50Ω
VSWR	2.0 Max.

*Ground plane size 110x40 mm

3. Test Setup



(a)

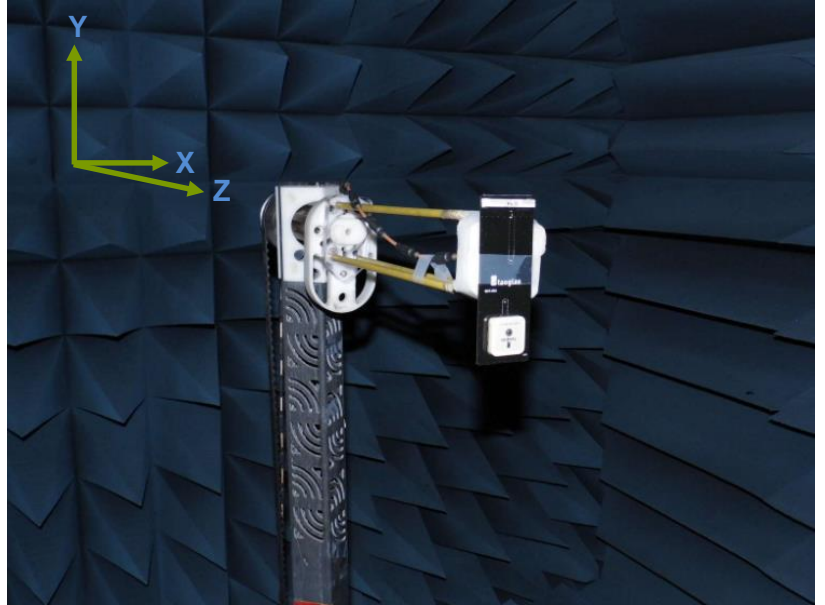

(b)

Figure 2. (a) PA.25 Cellular antenna Return Loss and VSWR test setup; (b) Peak gain, Average gain, Efficiency and Radiation pattern test setup

PA.25 Cellular Antenna

3.1 Return Loss

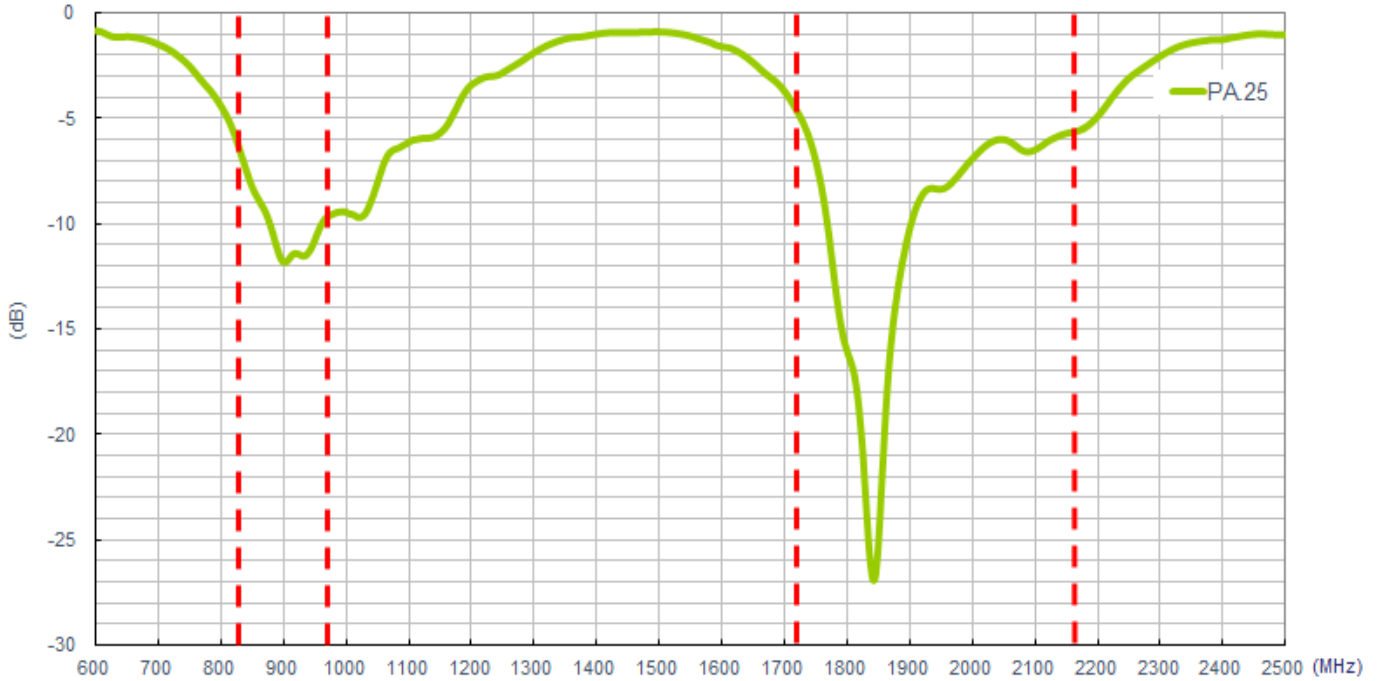

Figure 3. Return Loss of the PA.25 Cellular Antenna

3.2 Efficiency

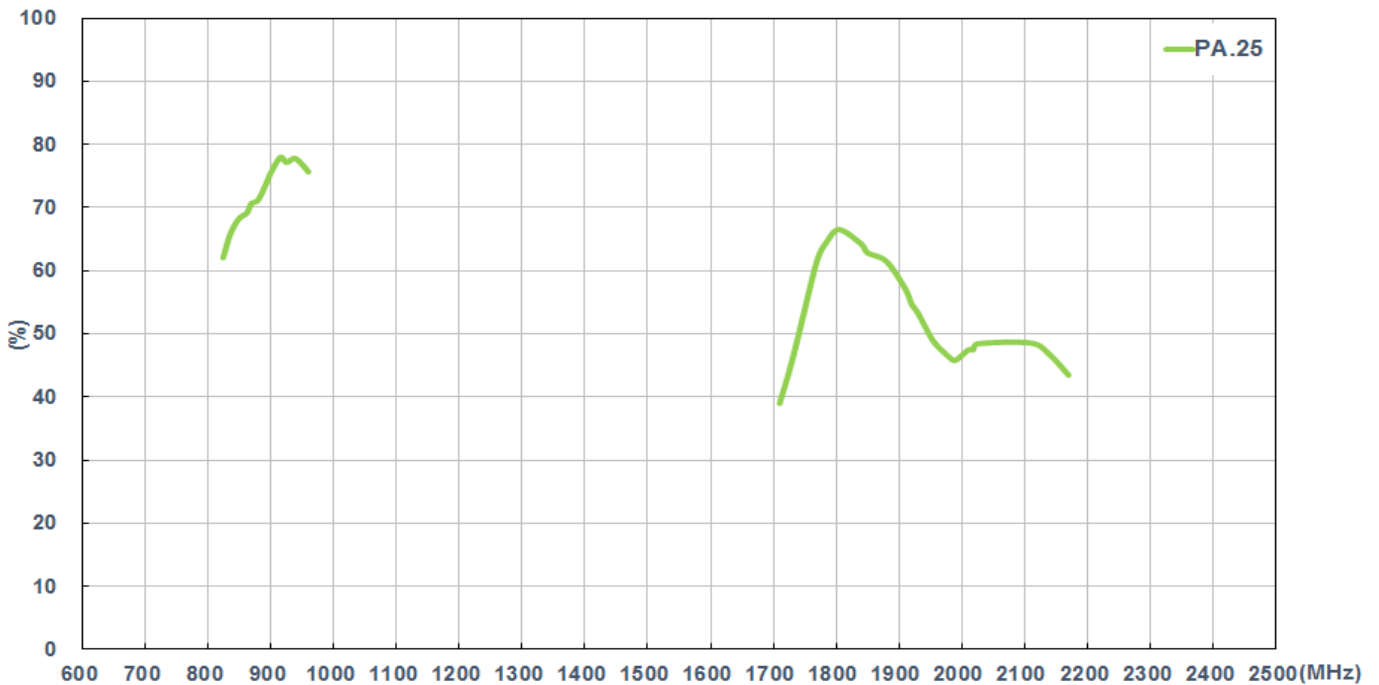

Figure 4. Efficiency of the PA.25 Cellular Antenna

3.3 Peak Gain

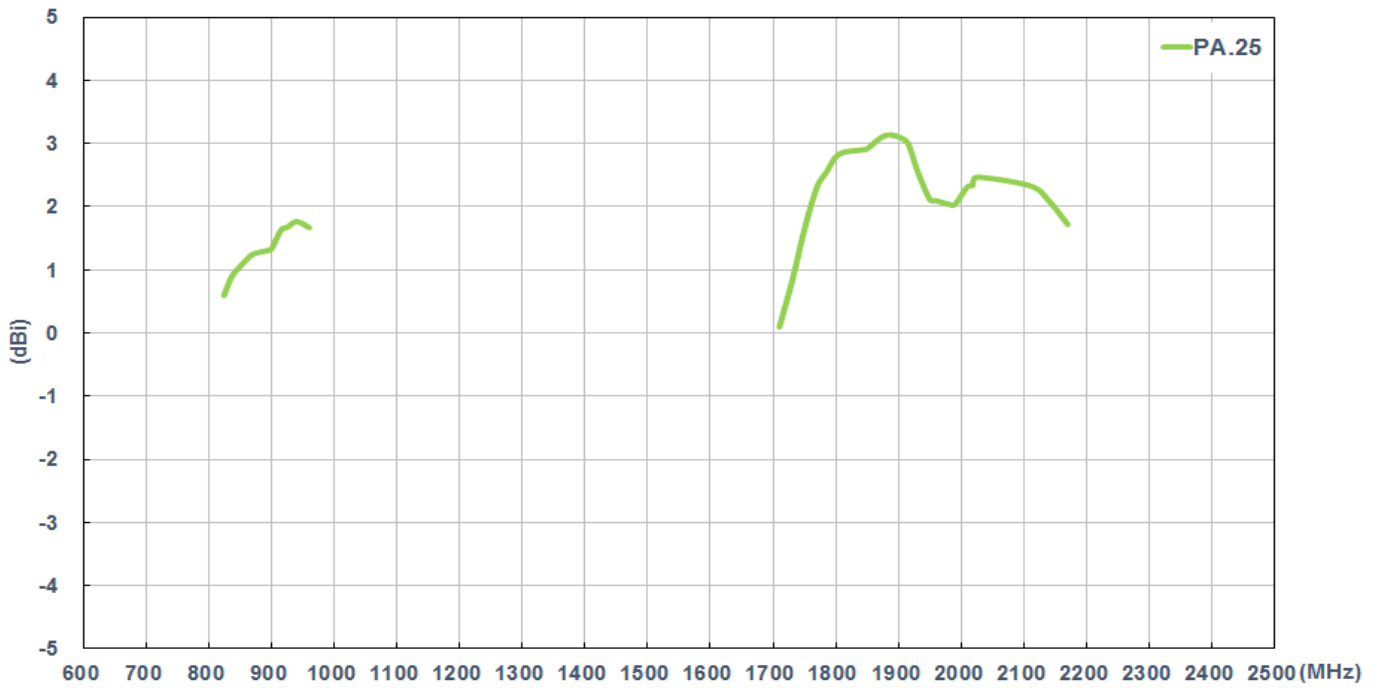

Figure 5. Peak Gain of the PA.25 Cellular Antenna

3.4 Average Gain

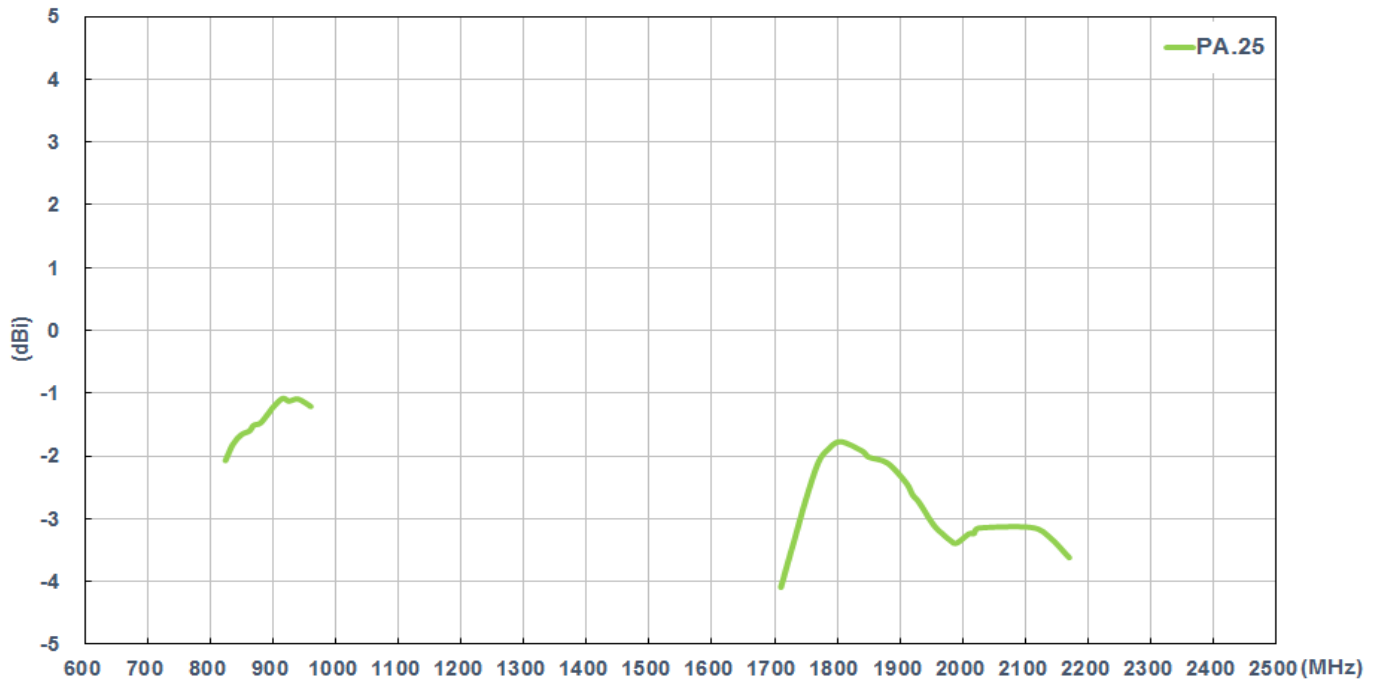
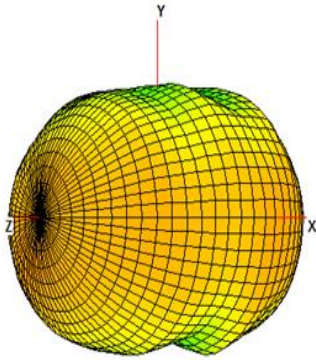

Figure 6. Average Gain of the PA.25 Cellular Antenna

3.5 3D Radiation Pattern

Azimuth=0.0
Elevation=0.0
Roll=-45.0



880MHz

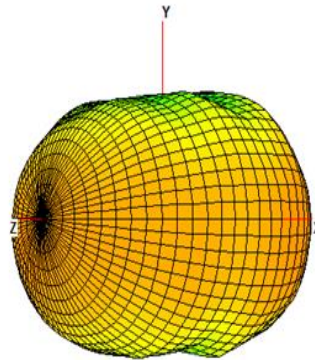

960MHz

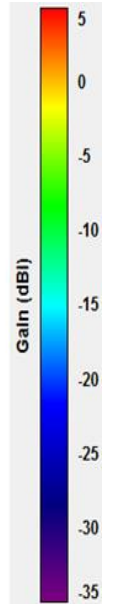

Azimuth=0.0
Elevation=0.0
Roll=-45.0

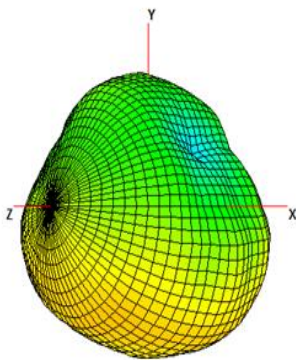

1710MHz

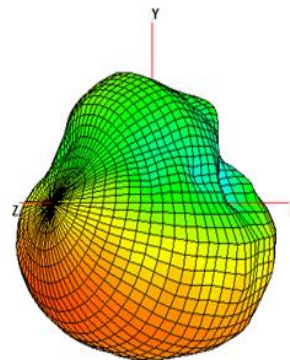

1880MHz

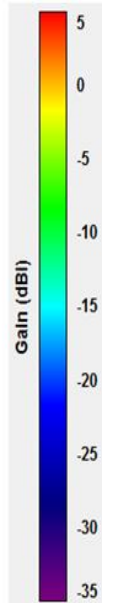

Azimuth=0.0
Elevation=0.0
Roll=-45.0

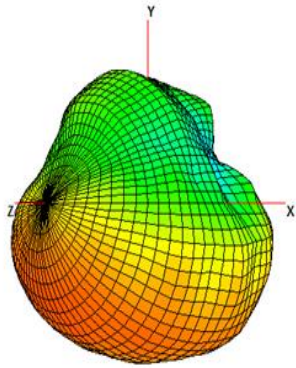

1850MHz

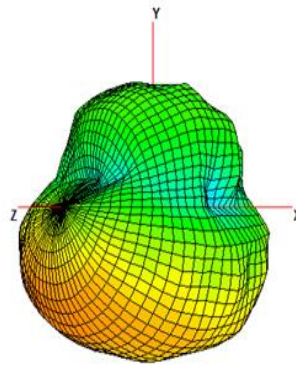

1990MHz

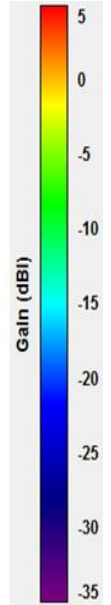

Azimuth=0.0
Elevation=0.0
Roll=-45.0

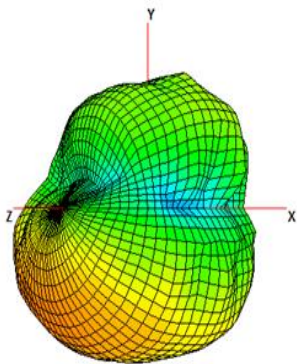

2110MHz

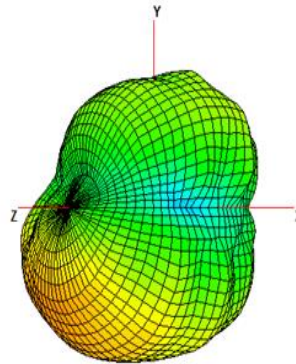

2170MHz

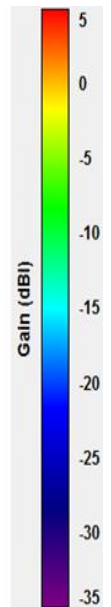
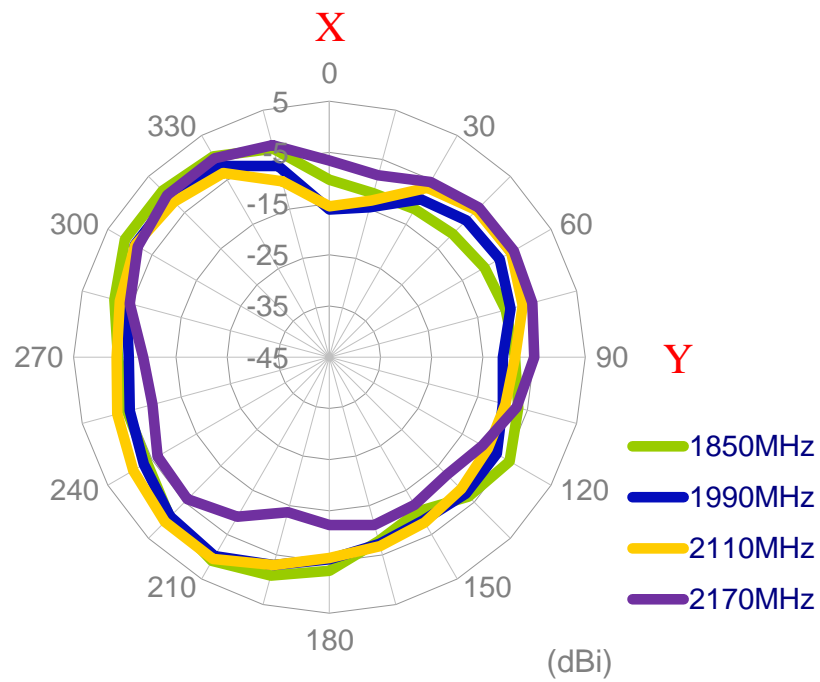
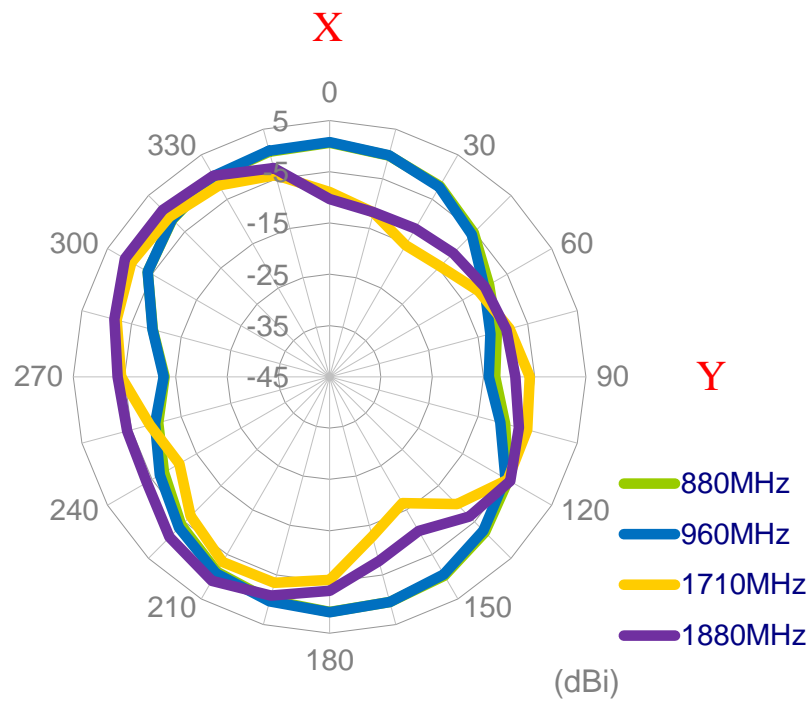

Figure 7. 3D Radiation Pattern of the PA.25 Cellular Antenna

3.6 2D Radiation Pattern

X-Y plane



Y-Z plane

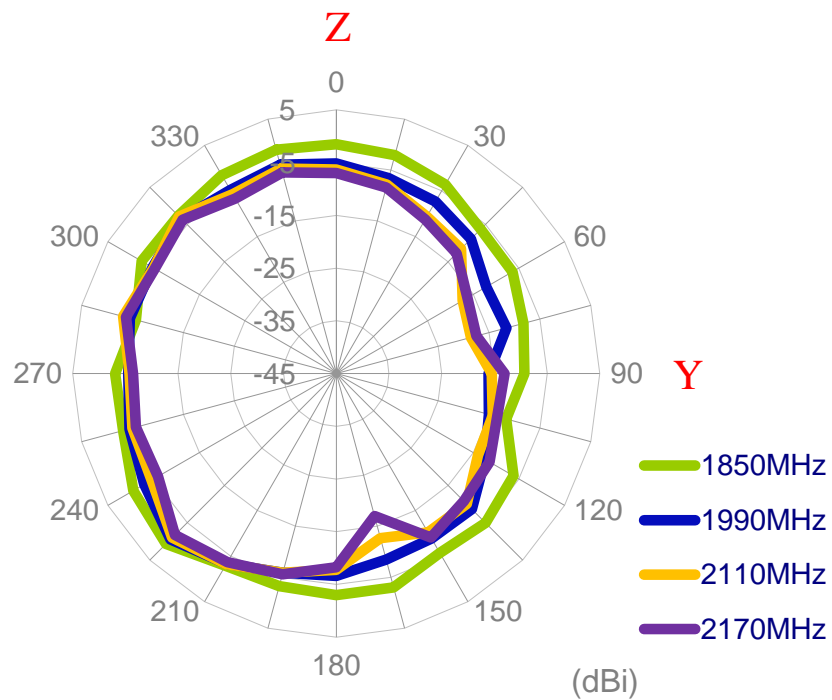
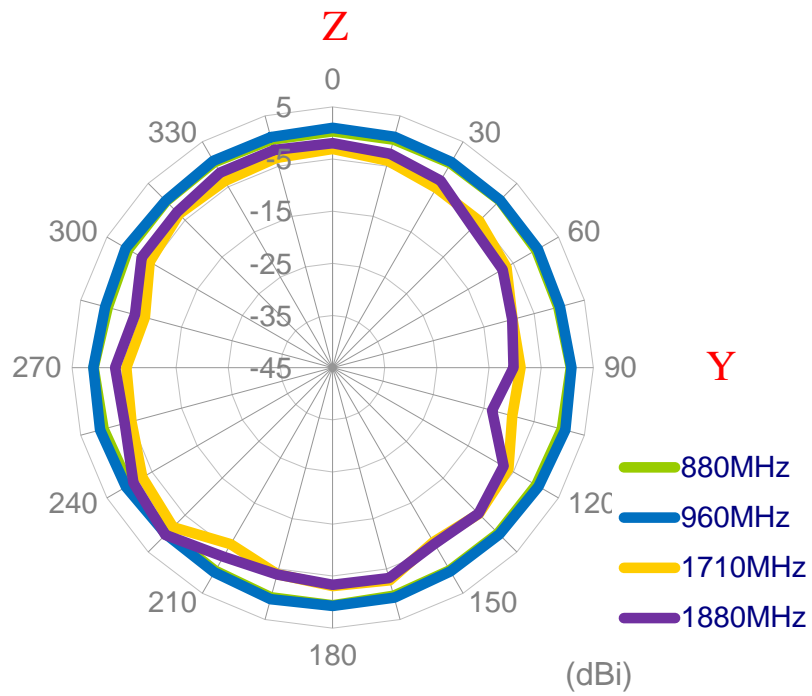

X-Z plane

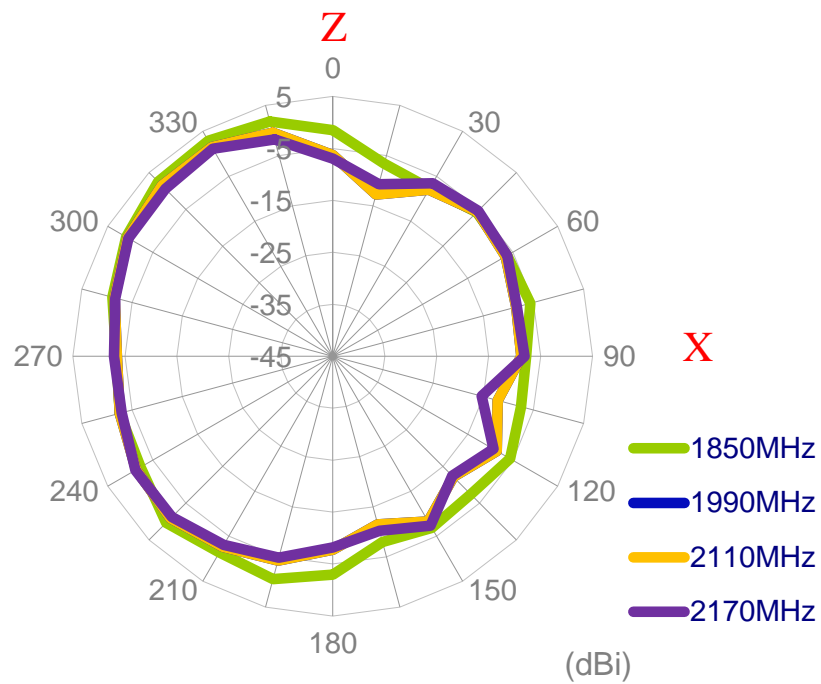
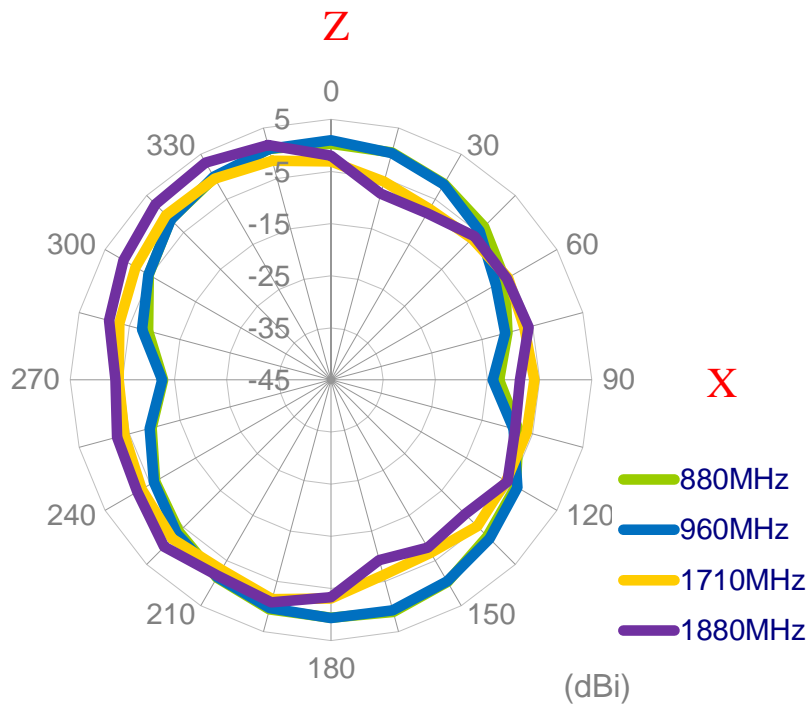

Figure 8. 2D Radiation Pattern of the PA.25 cellular antenna

4. ASGP.1575.25B.4.A.01 Active GPS Antenna

4.1 LNA Gain and Out Band Rejection @3.0V

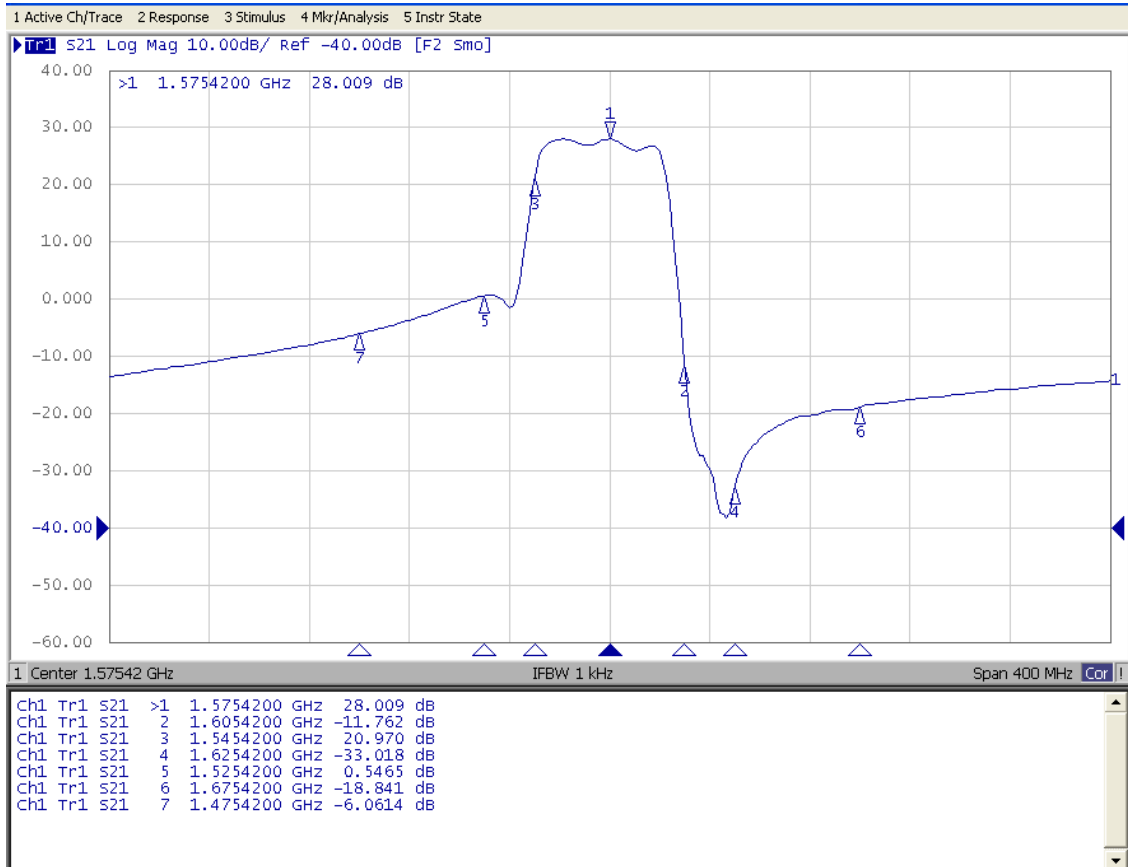

Figure 9. LNA Gain and Out Band Rejection @3.0V

4.2 LNA Noise Figure @3.0V

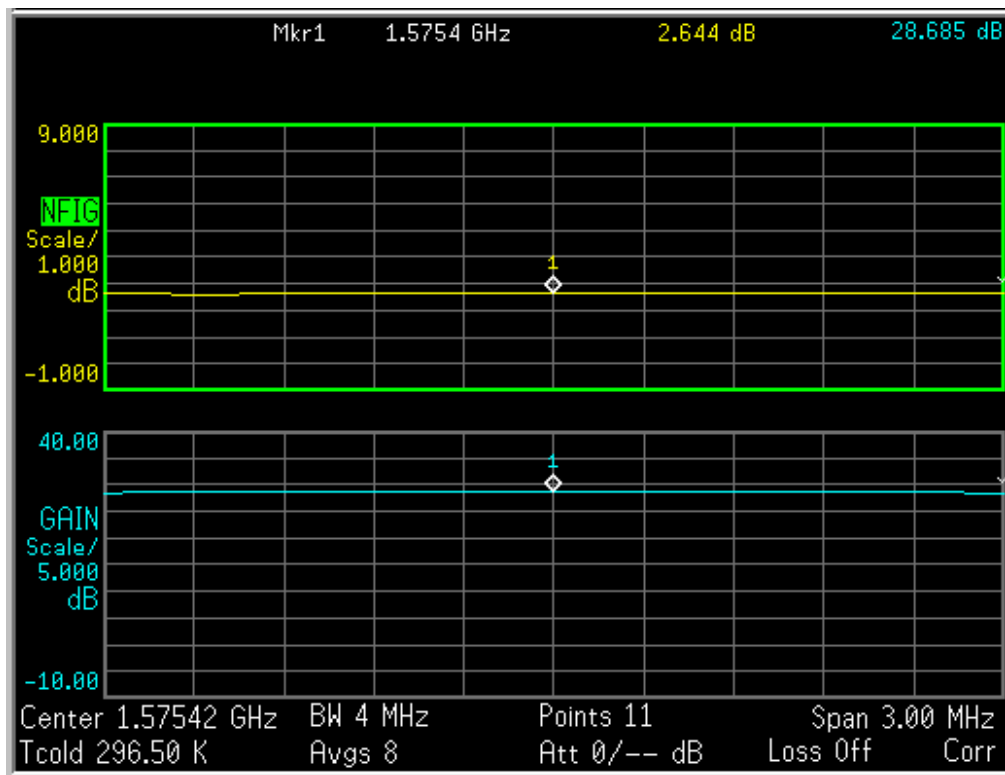

Figure 10. LNA Noise figure @3.0V

4.3 GPS Antenna Radiation Pattern

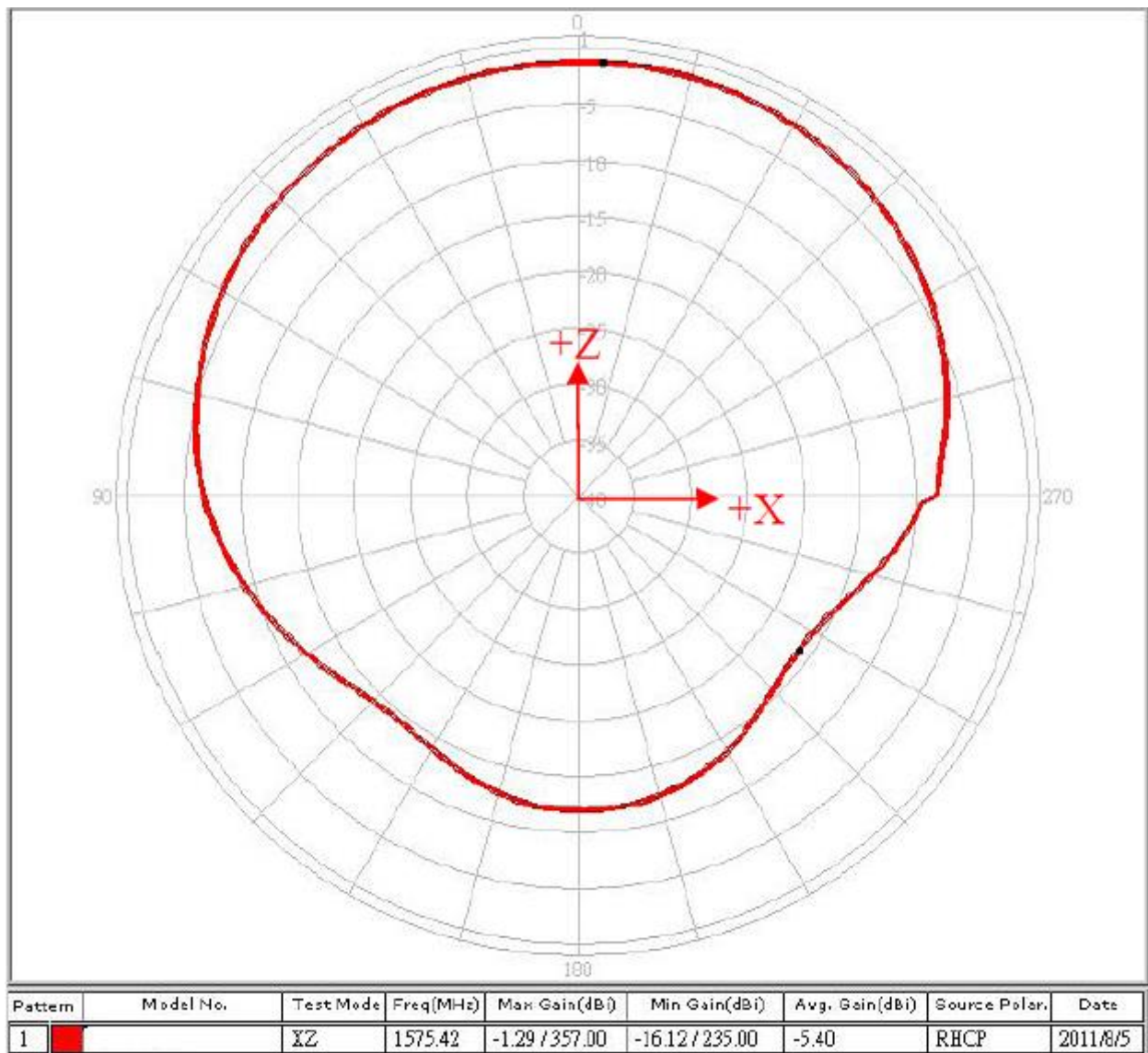

Figure 11. X-Z plane

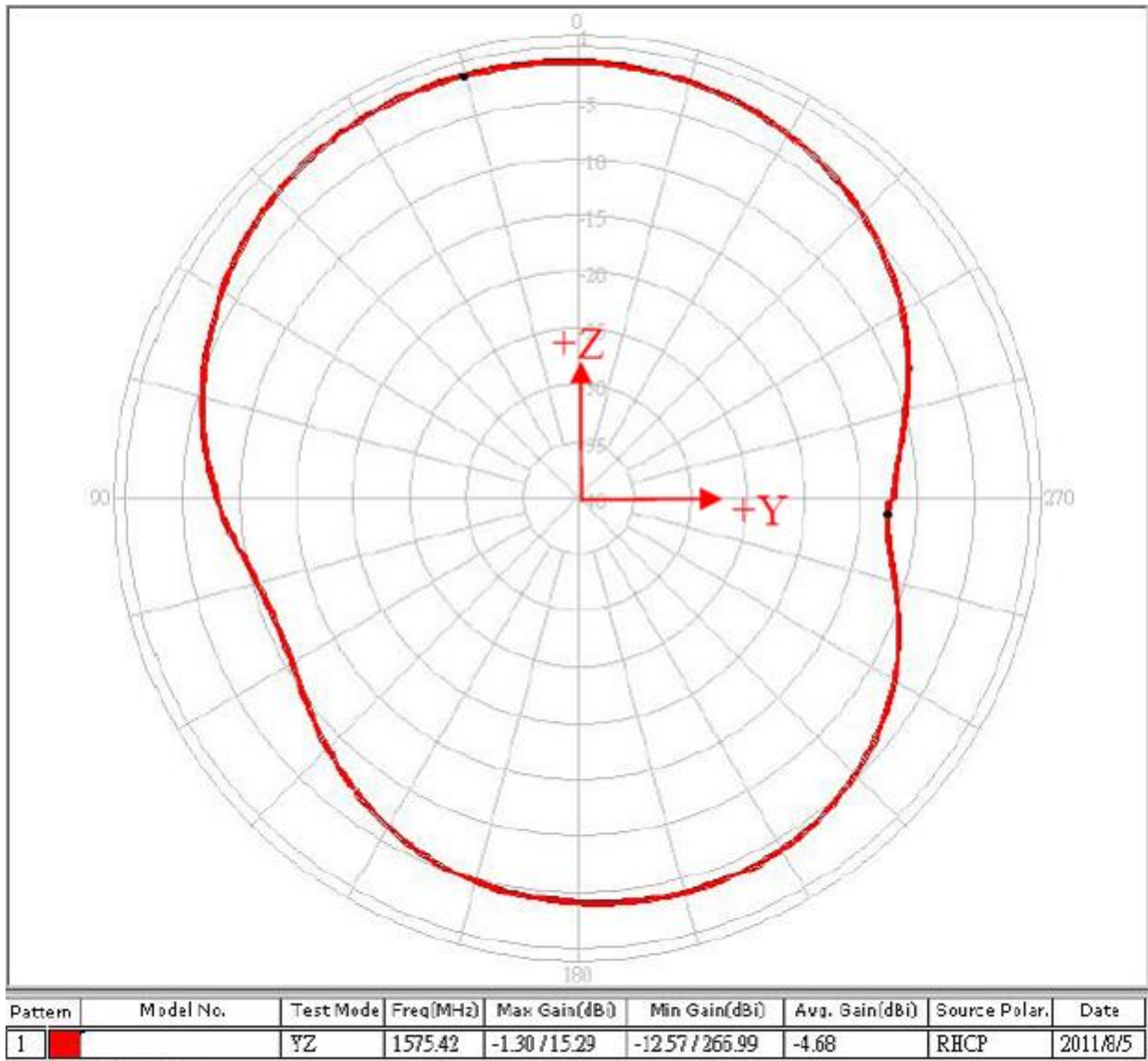

Figure 12. Y-Z plane

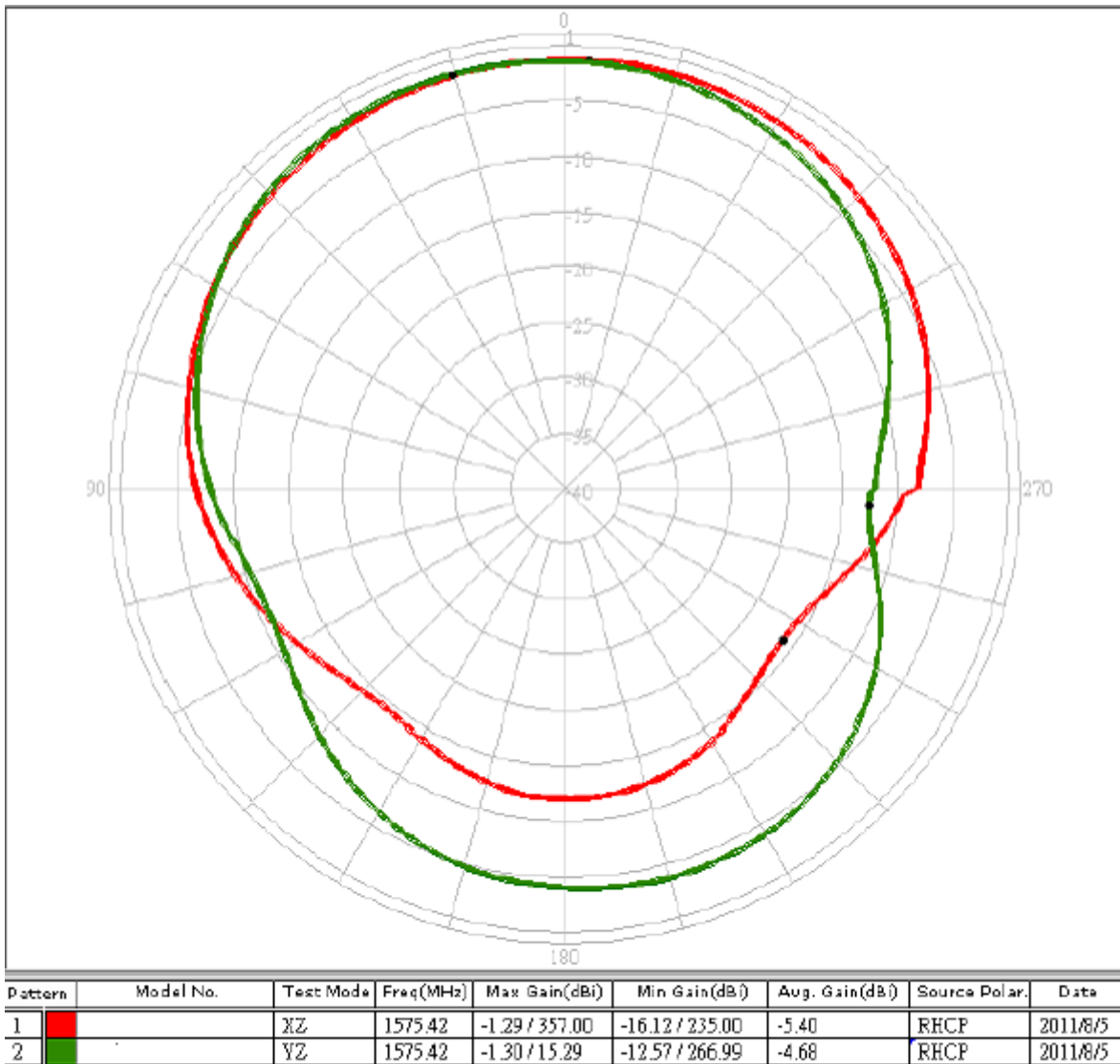

Figure 13. X-Y plane

5. Mechanical Drawing

PA.25 Mechanical Drawing

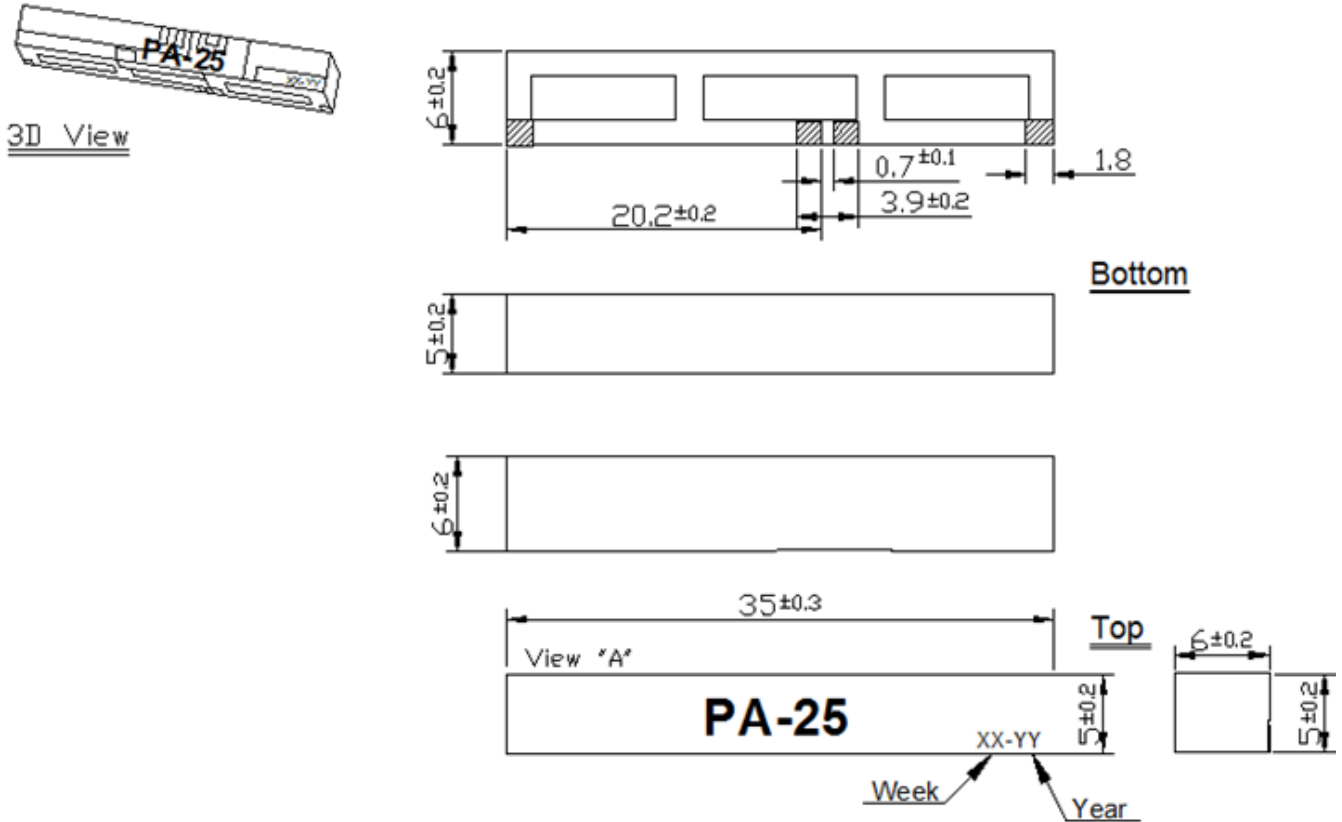

Figure 15. Mechanical Drawing of the PA.25 Antenna.

ASGP.1575.25B.4.A.01 Mechanic Drawing

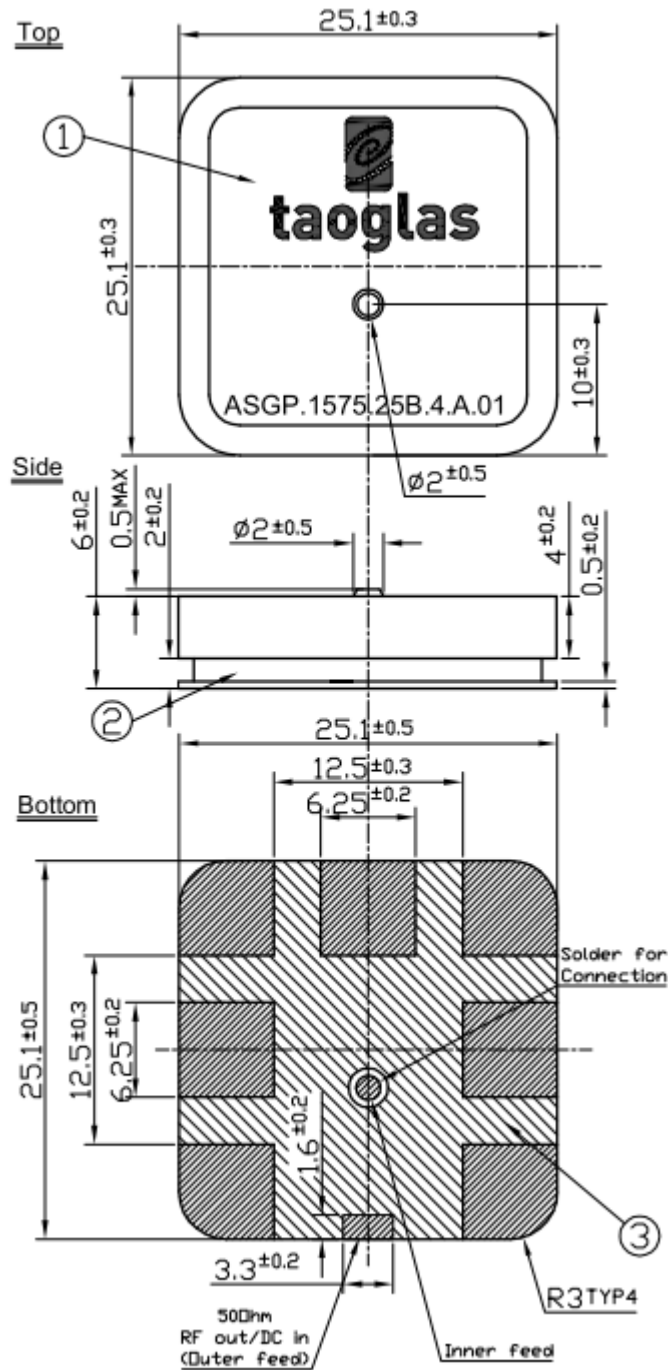

Figure 16. Mechanical Drawing of the ASGP.1575.25B.4.A.01 Active GPS Antenna

6. Layout Dimensions

6.1 PA.25 Layout Dimension

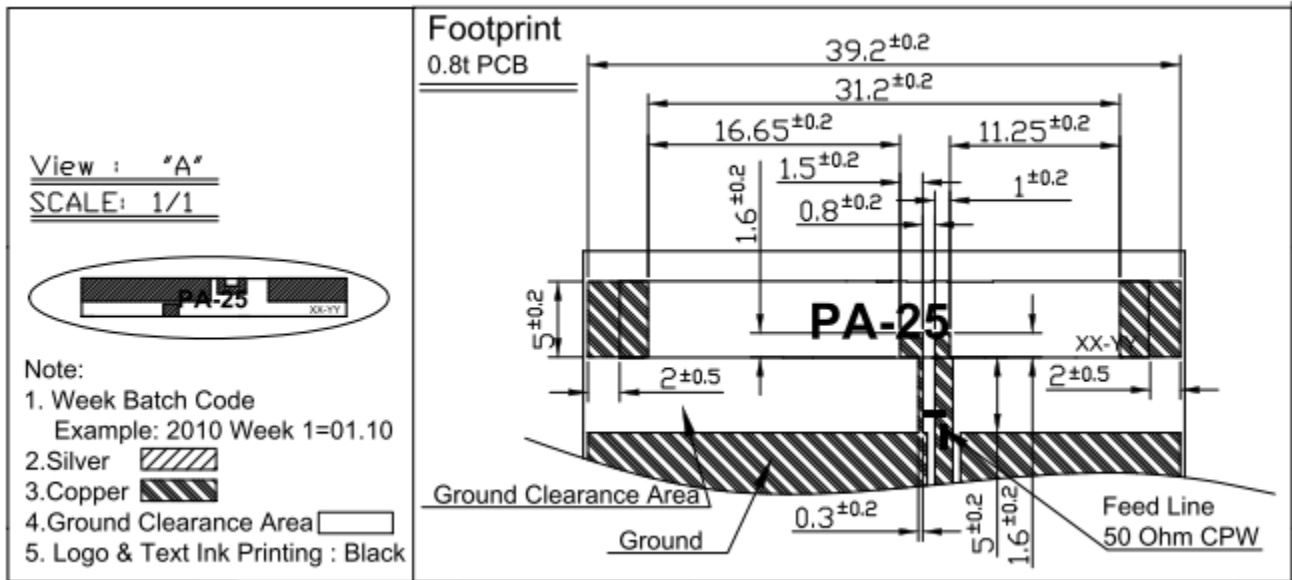

Figure 17. Layout dimensions of the PA.25 Antenna.

6.2 ASGP.1575.25B.4.A.01 Layout Dimension

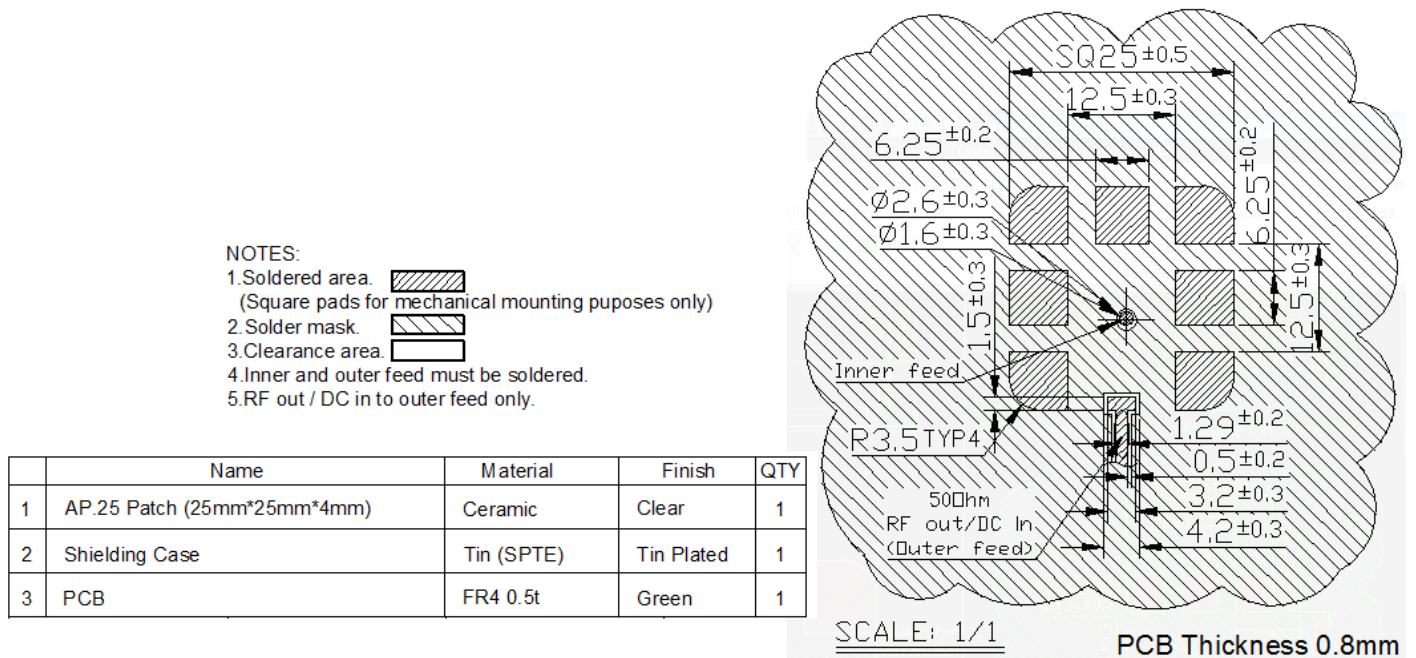

Figure 18. Layout dimensions of the ASGP.1575.25B.4.A.01 Antenna

7. EVB Dimension

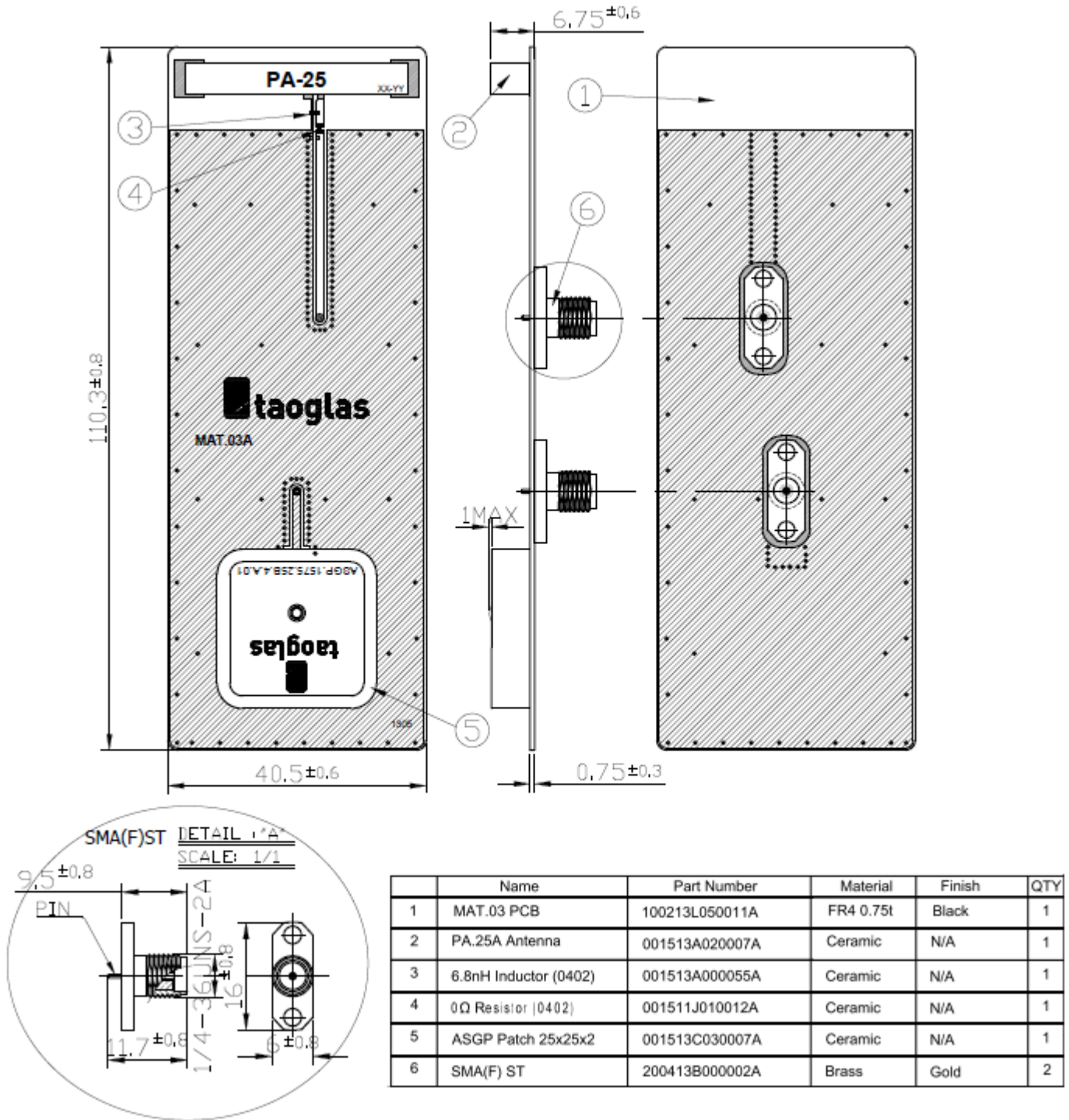
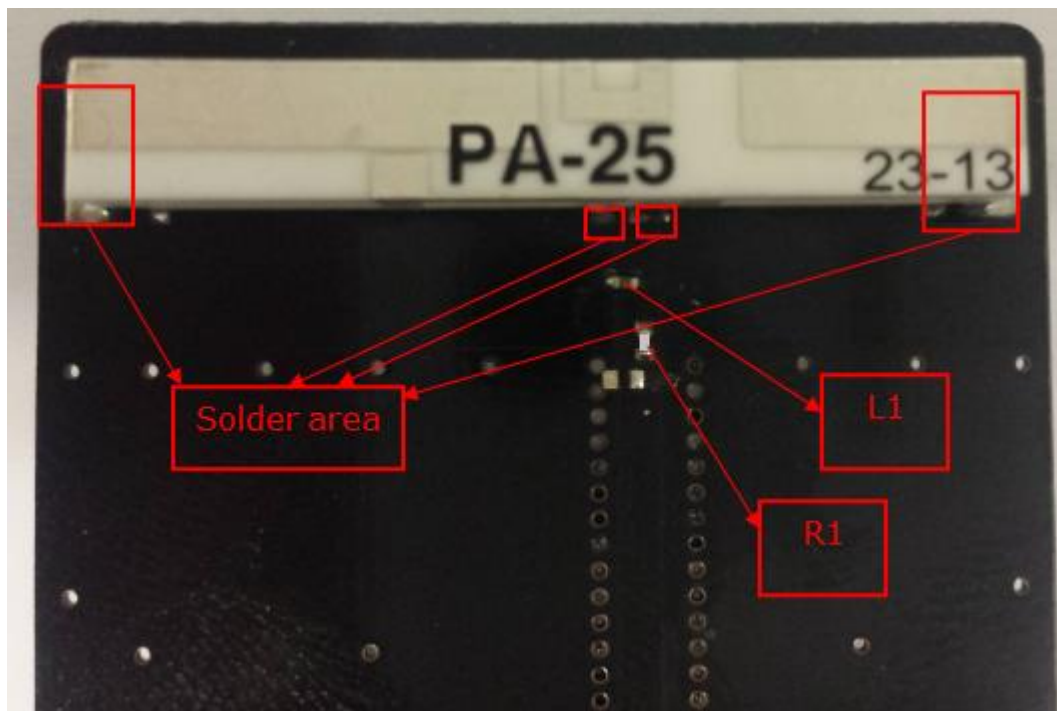
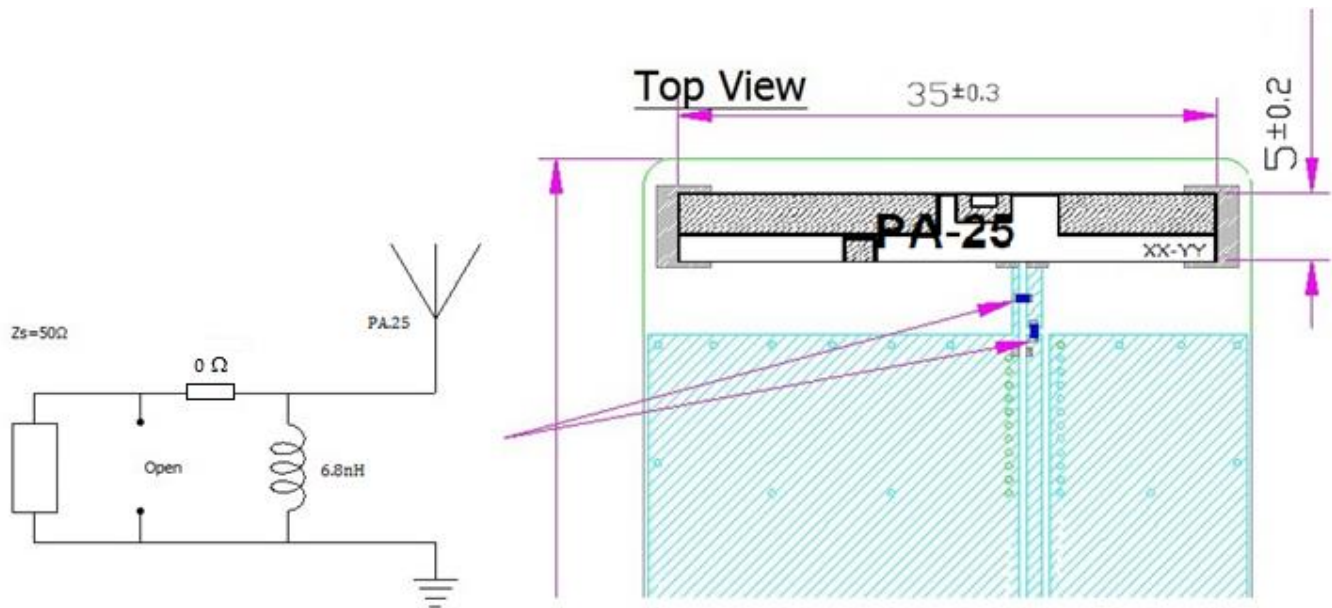

Figure 19. EVB Dimension of MAT.03A Antenna

8. Matching Circuit (PA.25)



Circuit Symbol	Size	Description
L1	0402	6.8nH inductor (001513A000055A)
R1	0402	0Ω resistor (001511J010012A)

Figure 20. Recommended matching circuit

9. Packaging

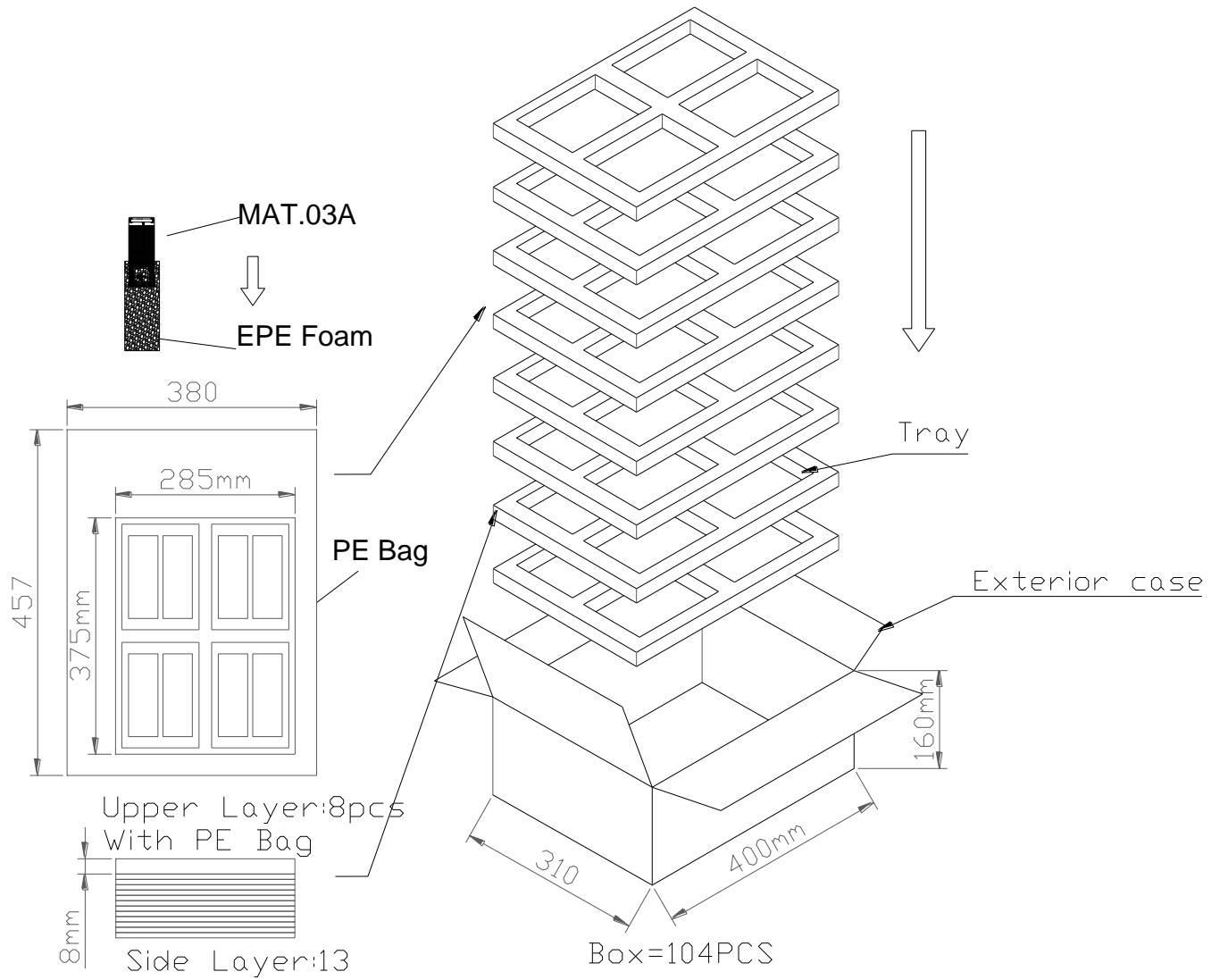

10. Recommended Reflow Temperature Profile

PA.25 and ASGP.1575.25B.4.A.01 can be assembled following either Sn-Pb or Pb-Free assembly processes. The recommended soldering temperatures are as follows:

Phase	Profile Features	Sn-Pb Assembly	Pb-Free Assembly (SnAgCu)
Ramp-Up	Avg. Ramp-Up Rate (T _{smax} to TP)	3°C/second (max)	3°C/second (max)
Preheat	Temperature Min (T _{smin})	100°	100°
	Temperature Max (T _{smax})	150°	150°
	Time (t _{smin} to t _{smax})	60-120 seconds	60-120 seconds
Reflow	Temperature (T _L)	183°C	217°C
	Total Time Above T _L b(t _L)	60-150 seconds	60-150 seconds
Peak	Temperature (T _p)	235°C	260°C
	Time (t _p)	10-30 seconds	20-40 seconds
Ramp-Down	Rate	6°C/second (max)	6°C/second (max)
Time from 25°C to peak Temperature		6 minutes max	8 minutes max

Temperature profile – (green area) for the assembly process in reflow ovens

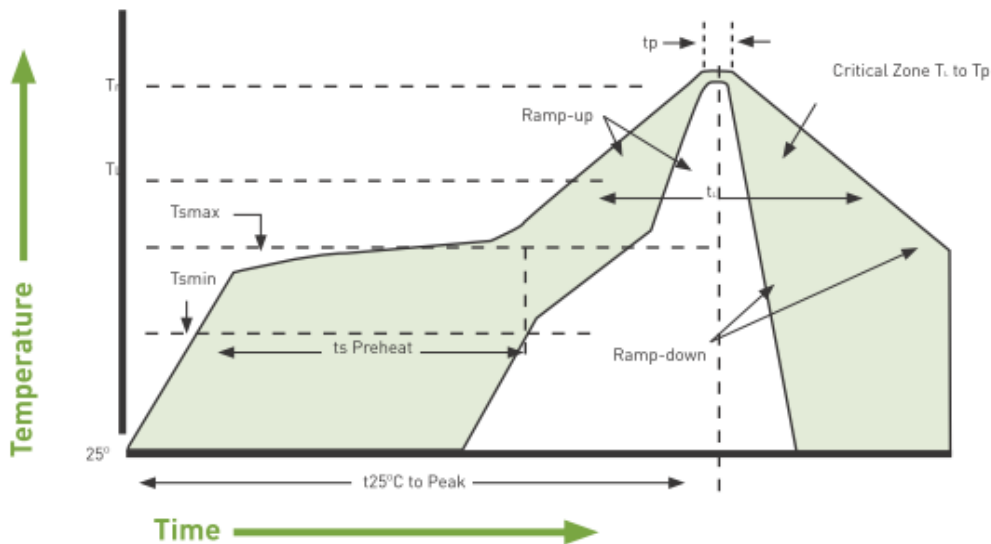

Figure 21. Temperature profile for the assembly process in reflow ovens

Taoglas makes no warranties based on the accuracy or completeness of the contents of this document and reserves the right to make changes to specifications and product descriptions at any time without notice. Taoglas reserves all rights to this document and the information contained herein. Reproduction, use or disclosure to third parties without express permission is strictly prohibited. Copyright © 2014, Taoglas Ltd.