

SERIES: P78-500 | **DESCRIPTION:** NON-ISOLATED SWITCHING REGULATOR

FEATURES

- 0.5 A output current
- up to 10:1 input range (9~90 Vdc)
- straight and bent pin options
- certified to EN/IEC 62368
- no-load input current as low as 1.5 mA
- -40°C to +85°C temperature range

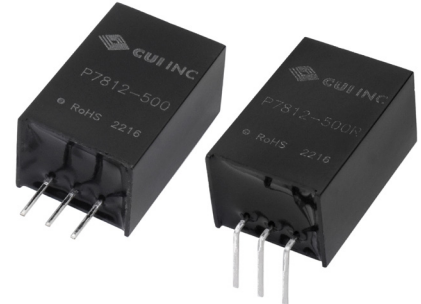

MODEL	input voltage ¹		output voltage (Vdc)	output current max (mA)	output power max (W)	ripple and noise ² max (mVp-p)	efficiency	
	typ (Vdc)	range (Vdc)					Vin min (%)	Vin max (%)
P7803-500	48	9 ~ 90	3.3	500	1.65	80	82	69
P7805-500	48	9 ~ 90	5.0	500	2.50	80	87	75
P7806-500	48	9 ~ 90	6.5	500	3.25	80	91	78
P7809-500	48	14 ~ 90	9.0	500	4.50	80	91	80
P7812-500	48	18 ~ 90	12.0	500	6.0	80	91	83
P7815-500	48	20 ~ 90	15.0	500	7.50	80	93	84
P7824-500	48	36 ~ 90	24.0	300	7.2	80	93	85

Notes: 1. For input voltage exceeding 80 Vdc, an input capacitor of 22µF/100V is required.
2. The ripple and noise are measured at 20 MHz BW using the parallel cable method at nominal input voltage, full load. See Application notes.

PART NUMBER KEY

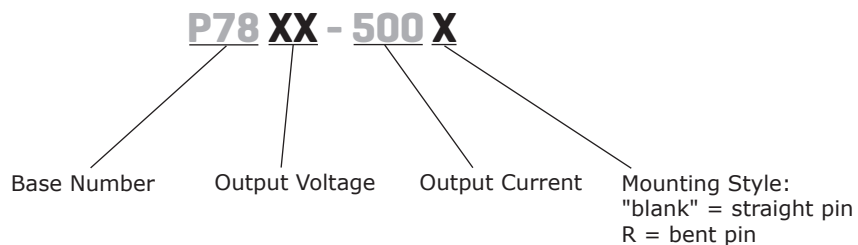

INPUT

parameter	conditions/description	min	typ	max	units
no load input current	at nominal input			1.5	mA
reverse polarity at input	avoid / not protected				
input filter	capacitance filter				

OUTPUT

parameter	conditions/description	min	typ	max	units
line regulation	Vin = min ~ max, at full load		±0.6	±1.5	%
	3.3, 5, 6.5 Vdc output models		±0.6	±2.0	%
	9, 12, 15 Vdc output models		±1.2	±2.5	%
	24 Vdc output model				
load regulation	at nominal input, 10% ~ 100% load		±1.0	±2.0	%
voltage accuracy	at nominal input, 10% ~ 100% load				
	3.3 Vdc output model		±3.5	±4.5	%
	all other output models		±2.0	±3.0	%
switching frequency ³	at nominal input, full load		330		kHz
temperature coefficient	-40°C ~ 80°C			±0.03	%/°C
transient response deviation	at nominal input, 25% load step change		±0.4	±1.5	%
transient recovery time	at nominal input, 25% load step change		0.2	1	ms

Note: 3. Different output voltage with different switching frequency.

PROTECTIONS

parameter	conditions/description	min	typ	max	units
short circuit protection	continuous, auto recovery				

SAFETY AND COMPLIANCE

parameter	conditions/description	min	typ	max	units
safety approvals	certified to 62368: EN, IEC				
conducted emissions	CISPR32/EN55032 Class B (see Figure 2-2)				
radiated emissions	CISPR32/EN55032 Class B (see Figure 2.2)				
ESD	IEC/EN 61000-4-2 Contact±4kV, perf. Criteria B				
radiated immunity	IEC/EN 61000-4-3 10V/m, perf. Criteria B				
EFT/burst	IEC/EN 61000-4-4 100kHz±1kV, perf. Criteria B (see Figure 2-1)				
surge	IEC/EN 61000-4-5 line to line±1kV, perf. Criteria B (see Figure 2-1)				
conducted immunity	IEC/EN 61000-4-6 3Vr.m.s, perf. Criteria B				
MTBF	as per MIL-HDBK-217 at 25°C	2,000,000			hours
RoHS compliant	yes				

ENVIRONMENTAL

parameter	conditions/description	min	typ	max	units
operating temperature		-40		85	°C
storage temperature		-55		125	°C
storage humidity	non-condensing	5		95	%
pin soldering resistance temperature	1.5 mm from case for 10 seconds			300	°C

DERATING CURVES

TEMPERATURE DERATING CURVE
3V, 5V, 6V, 9V, 12V, 15V models

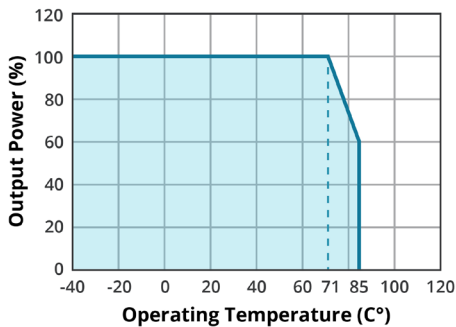

TEMPERATURE DERATING CURVE
24V model

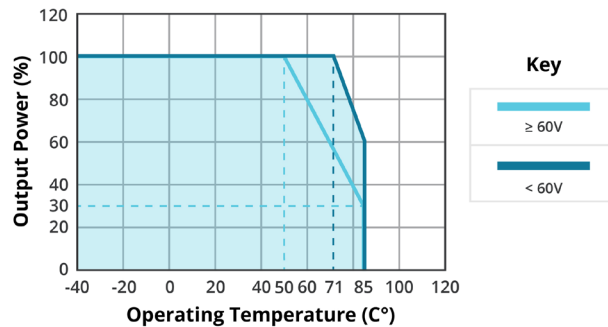

MECHANICAL

parameter	conditions/description	min	typ	max	units
dimensions	straight pin models: 17.50 x 11.50 x 9.00 [0.689 x 0.453 x 0.354 inch] bent pin models: 19.00 x 11.50 x 9.00 [0.748 x 0.453 x 0.354 inch]				mm mm
case material	black plastic, flame retardant and heat resistant (UL94-V0)				
weight			3.8		g
cooling	natural convection				

MECHANICAL DRAWING

units: mm [inches]
tolerance: ± 0.50 [± 0.020]
pin section tolerance: ± 0.10 mm [± 0.004]

Straight pin

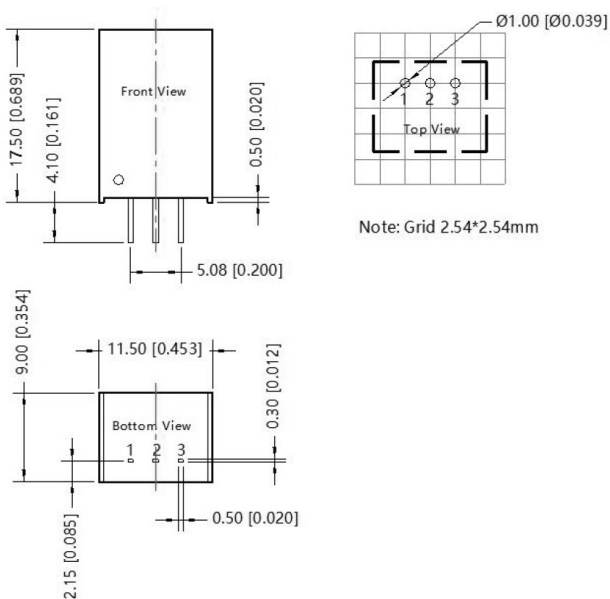

Bent pin

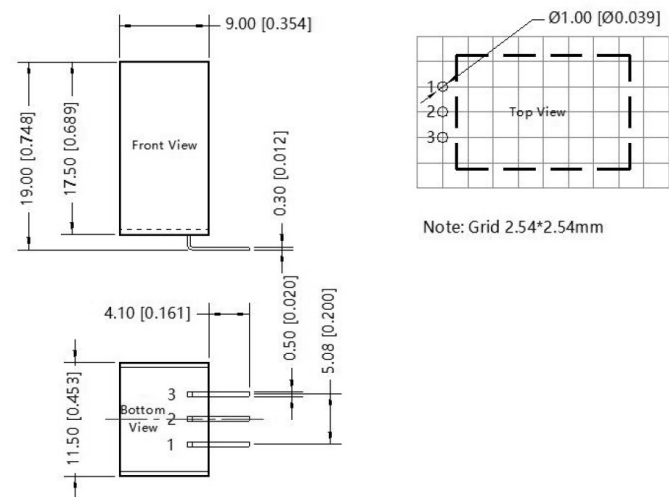

PIN CONNECTIONS	
PIN	FUNCTION
1	+Vin
2	GND
3	+Vo

TYPICAL APPLICATION CIRCUIT

Figure 1

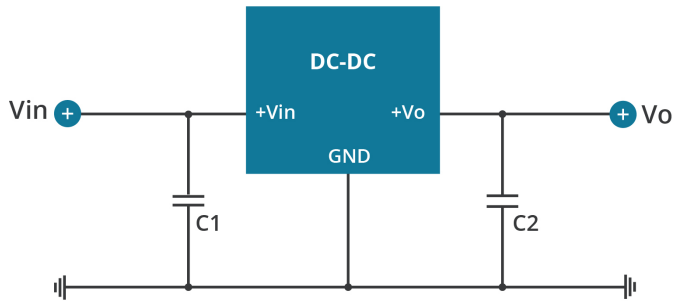

Table 1

Output Voltage (Vdc)	C1 (ceramic capacitor)	C2 (ceramic capacitor)
3.3, 5, 6.5	10 μ F/100V	22 μ F/10V
9		22 μ F/16V
12, 15		22 μ F/25V
24		10 μ F/50V

1. The required C1 and C2 capacitors must be connected as close as possible to the module.
2. Refer to Table 1 for C1 and C2 capacitor values. For certain applications, increased values and/or tantalum or low ESR electrolytic capacitors may also be used instead.
3. Converter cannot be used for hot swap and with output in parallel.

EMC RECOMMENDED CIRCUIT

Figure 2

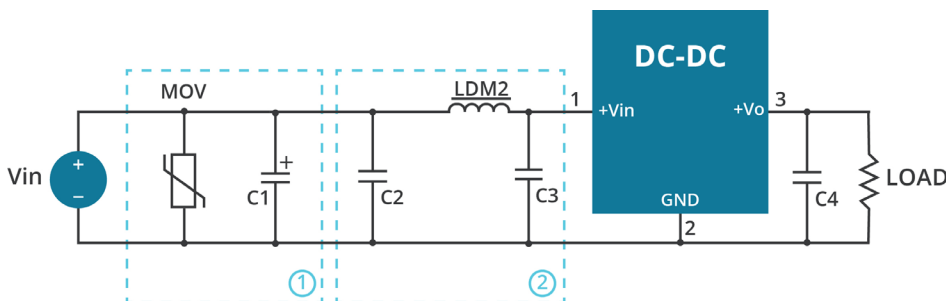

Table 2

Component	Recommended value
MOV	S20K30
C1	680 μ F/100V
C2	4.7 μ F/100V
LDM2	120 μ H
C3	4.7 μ F/100V
C4	10 μ F/50V

REVISION HISTORY

rev.	description	date
1.0	initial release	05/26/2022

The revision history provided is for informational purposes only and is believed to be accurate.



CUI INC
a bel group

Headquarters
20050 SW 112th Ave.
Tualatin, OR 97062
800.275.4899

Fax 503.612.2383
cui.com
techsupport@cui.com

CUI offers a two (2) year limited warranty. Complete warranty information is listed on our website.

CUI reserves the right to make changes to the product at any time without notice. Information provided by CUI is believed to be accurate and reliable. However, no responsibility is assumed by CUI for its use, nor for any infringements of patents or other rights of third parties which may result from its use.

CUI products are not authorized or warranted for use as critical components in equipment that requires an extremely high level of reliability. A critical component is any component of a life support device or system whose failure to perform can be reasonably expected to cause the failure of the life support device or system, or to affect its safety or effectiveness.