



# P-DUKE POWER

## LKC05W Series

Tiny-Ripple DC-DC Converter  
Up to 5 Watts

**3**  
YEARS  
WARRANTY

ROHS  
COMPLIANT

REACH  
COMPLIANT



**Q TINY**  
RIPPLE



Automation



Datacom



IPC



Industry



Measurement



Telecom



Automobile



Boat



Charger



Medical



PV



Railway



**1600**  
VDC  
Isolation  
Voltage

**4 : 1**  
Wide  
Input  
Range

**6**  
sided  
Shielding

Internal  
EN55032  
Class  
Filter **B**

**LOW**  
Standby  
Power

REMOTE  
**ON**  
**OFF**

**TINY**  
Output  
Ripple

**OCP**

**OVP**

**SCP**

**UVP**

### PART NUMBER STRUCTURE

LKC05	-	24		S		05		W	-	CS
Series Name		Input Voltage (VDC)		Output Quantity		Output Voltage (VDC)		Input Range		Assembly Options
		05:4.5~12 24:9~36 48:18~75		S:Single		3P3:3.3 05:5 12:12 15:15 24:24		4:1		□: With Pin3 CS: Without Pin3, Pin12
				D: Dual		05:± 5 12:±12 15:±15 24:±24				
				DS: Dual with output isolation		05:5/5 12:12/12 15:15/15 24:24/24				

**TECHNICAL SPECIFICATION** All specifications are typical at nominal input, full load and 25°C unless otherwise noted

Model Number	Input Range	Output Voltage	Output Current @Full Load	Input Current @ No Load	Output Ripple & Noise	Efficiency	Maximum Capacitor Load
	VDC	VDC	mA	mA	mV	%	μF
LKC05-05S3P3W	4.5 ~ 12	3.3	1515	25	10	79	2200
LKC05-05S05W	4.5 ~ 12	5	1000	30		82	1000
LKC05-05S12W	4.5 ~ 12	12	416	30		87	220
LKC05-05S15W	4.5 ~ 12	15	333	35		87	150
LKC05-05S24W	4.5 ~ 12	24	208	35		88	100
LKC05-05D05W	4.5 ~ 12	±5	±500	30		84	± 680
LKC05-05D12W	4.5 ~ 12	±12	±208	30		85	± 150
LKC05-05D15W	4.5 ~ 12	±15	±166	40		86	± 150
LKC05-05D24W	4.5 ~ 12	±24	±104	40		87	± 100
LKC05-05DS05W	4.5 ~ 12	Vout1: 5 Vout2: 5	500 500	30		84	680 680
LKC05-05DS12W	4.5 ~ 12	Vout1: 12 Vout2: 12	208 208	30		85	150 150
LKC05-05DS15W	4.5 ~ 12	Vout1: 15 Vout2: 15	166 166	40		86	150 150
LKC05-05DS24W	4.5 ~ 12	Vout1: 24 Vout2: 24	104 104	40		87	100 100
LKC05-24S3P3W	9 ~ 36	3.3	1515	6		81	2200
LKC05-24S05W	9 ~ 36	5	1000	6		83	1000
LKC05-24S12W	9 ~ 36	12	416	9		88	220
LKC05-24S15W	9 ~ 36	15	333	10		88	150
LKC05-24S24W	9 ~ 36	24	208	10		89	100
LKC05-24D05W	9 ~ 36	±5	±500	6		84	± 680
LKC05-24D12W	9 ~ 36	±12	±208	9		85	± 150
LKC05-24D15W	9 ~ 36	±15	±166	10		86	± 150
LKC05-24D24W	9 ~ 36	±24	±104	10		87	± 100
LKC05-24DS05W	9 ~ 36	Vout1: 5 Vout2: 5	500 500	6		84	680 680
LKC05-24DS12W	9 ~ 36	Vout1: 12 Vout2: 12	208 208	9		85	150 150
LKC05-24DS15W	9 ~ 36	Vout1: 15 Vout2: 15	166 166	10		86	150 150
LKC05-24DS24W	9 ~ 36	Vout1: 24 Vout2: 24	104 104	10		86	100 100
LKC05-48S3P3W	18~ 75	3.3	1515	4		80	2200
LKC05-48S05W	18~ 75	5	1000	4		83	1000
LKC05-48S12W	18~ 75	12	416	4		86	220
LKC05-48S15W	18~ 75	15	333	4		87	150
LKC05-48S24W	18~ 75	24	208	6		88	100
LKC05-48D05W	18~ 75	±5	±500	6		83	± 680
LKC05-48D12W	18~ 75	±12	±208	4		85	± 150
LKC05-48D15W	18~ 75	±15	±166	5		86	± 150
LKC05-48D24W	18~ 75	±24	±104	6		87	± 100

Model Number	Input Range	Output Voltage	Output Current @Full Load	Input Current @ No Load	Output Ripple & Noise	Efficiency	Maximum Capacitor Load
	VDC	VDC	mA	mA	mV	%	μF
LKC05-48DS05W	18~ 75	Vout1: 5	500	6	10	83	680
		Vout2: 5	500				680
LKC05-48DS12W	18~ 75	Vout1: 12	208	4		85	150
		Vout2: 12	208				150
LKC05-48DS15W	18~ 75	Vout1: 15	166	5	86	150	
		Vout2: 15	166			150	
LKC05-48DS24W	18~ 75	Vout1: 24	104	6	86	100	
		Vout2: 24	104			100	

INPUT SPECIFICATIONS							
Parameter	Conditions			Min.	Typ.	Max.	Unit
Operating input voltage range	5Vin(nom)			4.5	5	12	VDC
	24Vin(nom)			9	24	36	
	48Vin(nom)			18	48	75	
Start up voltage	5Vin(nom)					4.5	VDC
	24Vin(nom)					9	
	48Vin(nom)					18	
Shutdown voltage	5Vin(nom)			3	4	4.4	VDC
	24Vin(nom)			7	8	8.8	
	48Vin(nom)			15	16	17.5	
Start up time	Constant resistive load	Power up		50	75		ms
		Remote ON/OFF		50	75		
Input surge voltage	1 second, max.	5Vin(nom)				16	VDC
		24Vin(nom)				50	
		48Vin(nom)				100	
Input filter	5Vin(nom)			Pi type			
	24Vin(nom)			Common Choke			
	48Vin(nom)			Common Choke			
Remote ON/OFF	Referred to -Vin pin	Positive logic	DC-DC ON			Open or 3 ~ 12VDC	
			DC-DC OFF			Short or 0 ~ 1.2VDC	
		Input current of Ctrl pin		-0.5		1	mA
		Remote off input current			3	1	mA

OUTPUT SPECIFICATIONS						
Parameter	Conditions		Min.	Typ.	Max.	Unit
Voltage accuracy			-1.0		+1.0	%
Minimum load	□□ <b>DS</b> □□W			10		%
Line regulation	Low Line to High Line at Full Load	□□ <b>S</b> □□W	-0.2		+0.2	%
		□□ <b>D</b> □□W	-0.2		+0.2	
		□□ <b>DS</b> □□W	-0.2		+0.2	
			-1.0		+1.0	
Load regulation	No Load to Full Load	□□ <b>S</b> □□W	-0.5		+0.5	%
		□□ <b>D</b> □□W	-1.0		+1.0	
	10% Full Load to Full Load	□□ <b>DS</b> □□W	-0.5		+0.5	
			-1.0		+1.0	
Cross regulation	Asymmetrical load 25%/100% FL	□□ <b>D</b> □□W	-3.0		+3.0	%
		□□ <b>DS</b> 05W	-0.5		+0.5	
			-6.0		+6.0	
		Others	-0.5		+0.5	
Voltage adjustability			-10		+20	%
			-10		+10	
			-10		+10	
			-10		+10	
Ripple and noise	Measured by 20MHz bandwidth			10	15	mVp-p
	Measured by 20MHz bandwidth, with additional 10μF Capacitor			5	10	
Temperature coefficient			-0.02		+0.02	%/°C
Transient response recovery time	50% load step change			250		μs
Over voltage protection	% of Vout(nom)			135		%
Over load protection	% of Iout rated; Hiccup mode			170		%
Short circuit protection			Continuous, automatic recovery			

GENERAL SPECIFICATIONS						
Parameter	Conditions		Min.	Typ.	Max.	Unit
Isolation voltage	1 minute	Input to Output	1600			VDC
		Input (Output) to Case	1600			
		Vout 1 to Vout 2; □□ <b>DS</b> □□W only	500			
Isolation resistance	500VDC		1			GΩ
Isolation capacitance					1200	pF
Switching frequency				300		kHz
Safety meets						IEC/ EN/ UL62368-1
Case material						Copper
Base material						FR4 PCB
Potting material						Epoxy (UL94 V-0)
Weight						15.3g(0.54oz)
MTBF	MIL-HDBK-217F, Full load					4.446 x 10 <sup>6</sup> hrs

ENVIRONMENTAL SPECIFICATIONS						
Parameter	Conditions		Min.	Typ.	Max.	Unit
Operating ambient temperature	Without derating		-40		+85	°C
	With derating		+85		+100	
Maximum case temperature					105	°C
Storage temperature range			-55		+125	°C
Thermal impedance				20		°C/W
Thermal shock			MIL-STD-810F			
Vibration			MIL-STD-810F			
Relative humidity			5% to 95% RH			

EMC SPECIFICATIONS			
Parameter	Conditions	Level	
EMI	EN55032		
	Without external components	Class A	
	LKC05-05□□□W LKC05-24□□□W	Do not need any external components.	Class B
	LKC05-48□□□W	Connect two 4.7μF/100V MLCCs in parallel to input pins	
EMS	EN55024		
ESD	EN61000-4-2	Air ± 8kV and Contact ± 6kV	Perf. Criteria A
Radiated immunity	EN61000-4-3	20 V/m	Perf. Criteria A
Fast transient	EN61000-4-4	± 2kV	Perf. Criteria A
	LKC05-05□□□W LKC05-24□□□W	With an aluminum electrolytic capacitor (Nippon chemi-con KY series, 220μF/100V) and a TVS(SMDJ70A, 70V, 3000Watt peak pulse power) in parallel.	
	LKC05-48□□□W	With an aluminum electrolytic capacitor (Nippon chemi-con KY series, 220μF/100V) and a TVS(SMDJ120A, 120V, 3000Watt peak pulse power) in parallel.	
Surge	EN61000-4-5	± 2kV	Perf. Criteria A
	LKC05-05□□□W LKC05-24□□□W	With an aluminum electrolytic capacitor (Nippon chemi-con KY series, 220μF/100V) and a TVS(SMDJ70A, 70V, 3000Watt peak pulse power) in parallel.	
	LKC05-48□□□W	With an aluminum electrolytic capacitor (Nippon chemi-con KY series, 220μF/100V) and a TVS(SMDJ120A, 120V, 3000Watt peak pulse power) in parallel.	
Conducted immunity	EN61000-4-6	10 Vr.m.s	Perf. Criteria A
Power frequency magnetic field	EN61000-4-8	100A/m continuous; 1000A/m 1 second	Perf. Criteria A

**CAUTION:** This power module is not internally fused. An input line fuse must always be used.

## CHARACTERISTIC CURVE

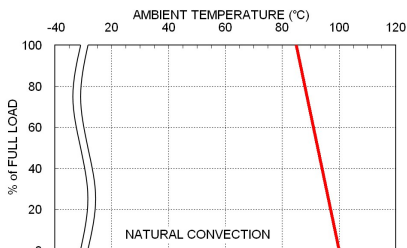

LKC05-48S05W Derating Curve

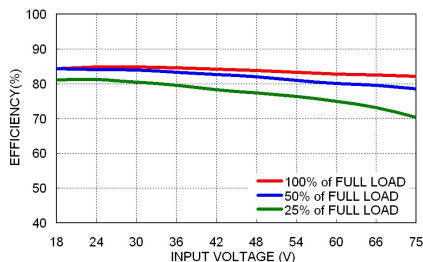

LKC05-48S05W Efficiency vs. Input Voltage

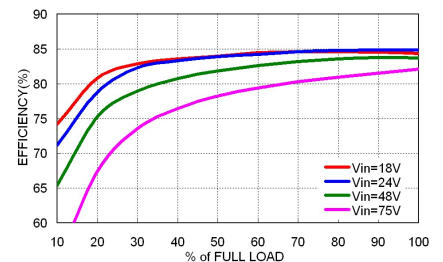

LKC05-48S05W Efficiency vs. Output Load

## FUSE CONSIDERATION

This power module is not internally fused. An input line fuse must always be used.

This encapsulated power module can be used in a wide variety of applications, ranging from simple stand-alone operation to an integrated part of sophisticated power architecture.

To maximum flexibility, internal fusing is not included; however, to achieve maximum safety and system protection, always use an input line fuse. The input line fuse suggest as below :

Model	Fuse Rating (A)	Fuse Type
LKC05-05S□□W \ LKC05-05D□□W \ LKC05-05DS□□W	2.5	Slow-Blow
LKC05-24S□□W \ LKC05-24D□□W \ LKC05-24DS□□W	1.25	Slow-Blow
LKC05-48S□□W \ LKC05-48D□□W \ LKC05-48DS□□W	1.6	Slow-Blow

The table based on the information provided in this data sheet on inrush energy and maximum DC input current at low Vin.

## MECHANICAL DRAWING

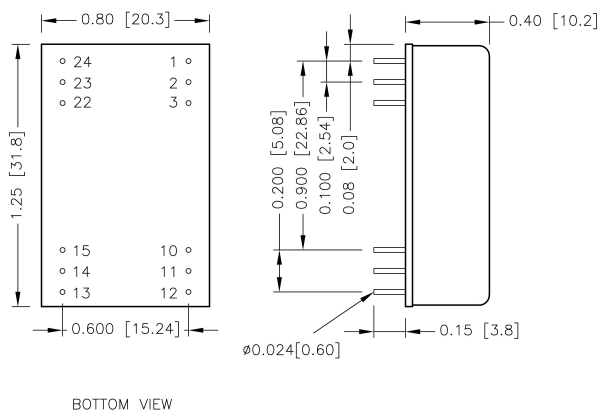

### PIN CONNECTION

#### LKC05-□□S□□W

PIN	DEFINE	PIN	DEFINE
1	+Vin	24	-Vin
2	+Vin	23	-Vin
3	Case	22	Ctrl
10	No pin	15	+Vout
11	No pin	14	-Vout
12	Case	13	Trim

#### LKC05-□□D□□W

PIN	DEFINE	PIN	DEFINE
1	+Vin	24	-Vin
2	+Vin	23	-Vin
3	Case	22	Ctrl
10	Com	15	Com
11	+Vout 1	14	-Vout 2
12	Case	13	Trim

#### LKC05-□□DS□□W

PIN	DEFINE	PIN	DEFINE
1	+Vin	24	-Vin
2	+Vin	23	-Vin
3	Case	22	Ctrl
10	-Vout 1(Aux)	15	+Vout 2(Main)
11	+Vout 1(Aux)	14	-Vout 2(Main)
12	Case	13	Trim

- All dimensions in inch [mm]
- Tolerance :x.xx±0.02 [x.x±0.5]  
x.xxx±0.01 [x.xx±0.25]
- Pin dimension tolerance ±0.004[0.10]

**RECOMMENDED PAD LAYOUT**

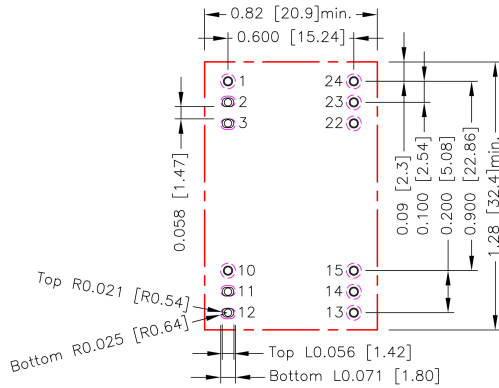

All dimensions in inch[mm]  
 Pad size(lead free recommended)  
 Through hole 1.2.3.10.11.12.13.14.15.22.23.24:  $\Phi$ 0.035[0.90]  
 Top view pad 1.10.13.14.15.22.23.24:  $\Phi$ 0.044[1.13]  
 Top view pad 2.3.11.12:Groove R0.021[0.54]L0.056[1.42]  
 Bottom view pad 1.10.13.14.15.22.23.24:  $\Phi$ 0.071[1.80]  
 Bottom view pad 2.3.11.12:Groove R0.025[0.64]L0.071[1.80]

**THERMAL CONSIDERATIONS**

The power module operates in a variety of thermal environments. However, sufficient cooling should be provided to help ensure reliable operation of the unit. Heat is removed by conduction, convection, and radiation to the surrounding Environment. Proper cooling can be verified by measuring the point as the figure below. The temperature at this location should not exceed “Maximum case temperature”. When Operating, adequate cooling must be provided to maintain the test point temperature at or below “Maximum case temperature”. You can limit this Temperature to a lower value for extremely high reliability.

- Thermal test condition with vertical direction by natural convection (20LFM).

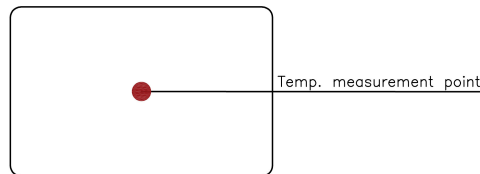

TOP VIEW

## OUTPUT VOLTAGE ADJUSTMENT

Output voltage set point adjustment allows the user to increase or decrease the output voltage set point of the module.

### LKC05-□□S□□W

This is accomplished by connecting an external resistor between the Trim pin and either the +Vout or -Vout pins.  
 With an external resistor between the Trim and -Vout pin, the output voltage set point increases.  
 With an external resistor between the Trim and +Vout pin, the output voltage set point decreases.

### LKC05-□□D□□W

This is accomplished by connecting an external resistor between the Trim pin and either the +Vout 1 or -Vout 2 pins.  
 With an external resistor between the Trim and -Vout 2 pin, the output voltage set point increases.  
 With an external resistor between the Trim and +Vout 1 pin, the output voltage set point decreases.

### LKC05-□□DS□□W

This is accomplished by connecting an external resistor between the Trim pin and either the +Vout 2(Main) or -Vout 2(Main) pins.  
 With an external resistor between the Trim and -Vout 2(Main) pin, the output voltage set point increases.  
 With an external resistor between the Trim and +Vout 2(Main) pin, the output voltage set point decreases.  
 The external TRIM resistor needs to be at least 1/16W of rated power.

### EXTERNAL OUTPUT TRIMMING

Output can be externally trimmed by using the method shown below.

Trim-up

### LKC05-□□S□□W

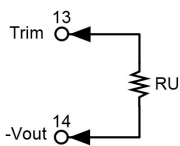

#### □□S3P3W

$\Delta V$ (%)	1	2	3	4	5	6	7	8	9	10
Vout (V)	3.333	3.366	3.399	3.432	3.465	3.498	3.531	3.564	3.597	3.630
RU (k $\Omega$ )	385.837	191.894	127.246	94.922	75.527	62.598	53.362	46.436	41.049	36.739
$\Delta V$ (%)	11	12	13	14	15	16	17	18	19	20
Vout (V)	3.663	3.696	3.729	3.762	3.795	3.828	3.861	3.894	3.927	3.960
RU (k $\Omega$ )	33.212	30.274	27.787	25.656	23.809	22.192	20.766	19.499	18.365	17.344

#### □□S05W

$\Delta V$ (%)	1	2	3	4	5	6	7	8	9	10
Vout (V)	5.050	5.100	5.150	5.200	5.250	5.300	5.350	5.400	5.450	5.500
RU (k $\Omega$ )	252.301	125.126	82.734	61.538	48.820	40.342	34.286	29.744	26.211	23.385
$\Delta V$ (%)	11	12	13	14	15	16	17	18	19	20
Vout (V)	5.550	5.600	5.650	5.700	5.750	5.800	5.850	5.900	5.950	6.000
RU (k $\Omega$ )	21.073	19.146	17.515	16.118	14.907	13.847	12.912	12.081	11.337	10.668

#### □□S12W

$\Delta V$ (%)	1	2	3	4	5	6	7	8	9	10
Vout (V)	12.120	12.240	12.360	12.480	12.600	12.720	12.840	12.960	13.080	13.200
RU (k $\Omega$ )	202.645	98.772	64.148	46.836	36.449	29.524	24.578	20.868	17.983	15.674
$\Delta V$ (%)	11	12	13	14	15	16	17	18	19	20
Vout (V)	13.320V	13.440	13.560	13.680	13.800	13.920	14.040	14.160	14.280	14.400
RU (k $\Omega$ )	13.786	12.212	10.880	9.739	8.750	7.884	7.120	6.441	5.834	5.287

#### □□S15W

$\Delta V$ (%)	1	2	3	4	5	6	7	8	9	10
Vout (V)	15.150	15.300	15.450	15.600	15.750	15.900	16.050	16.200	16.350	16.500
RU (k $\Omega$ )	161.024	77.962	50.275	36.431	28.125	22.587	18.632	15.665	13.358	11.512
$\Delta V$ (%)	11	12	13	14	15	16	17	18	19	20
Vout (V)	16.650	16.800	16.950	17.100	17.250	17.400	17.550	17.700	17.850	18.000
RU (k $\Omega$ )	10.002	8.744	7.679	6.766	5.975	5.283	4.672	4.129	3.643	3.206

#### □□S24W

$\Delta V$ (%)	1	2	3	4	5	6	7	8	9	10
Vout (V)	24.240	24.480	24.720	24.960	25.200	25.440	25.680	25.920	26.160	26.400
RU (k $\Omega$ )	568.197	277.598	180.732	132.299	103.239	83.866	70.028	59.650	51.577	45.120
$\Delta V$ (%)	11	12	13	14	15	16	17	18	19	20
Vout (V)	26.640	26.880	27.120	27.360	27.600	27.840	28.080	28.320	28.560	28.800
RU (k $\Omega$ )	39.836	35.433	31.707	28.514	25.746	23.325	21.188	19.289	17.589	16.060



## OUTPUT VOLTAGE ADJUSTMENT(CONTINUED)

Trim-up

LKC05-□□**D**□□W

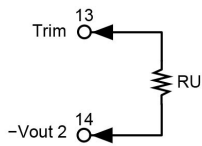

□□D05W

$\Delta V$ (%)	1	2	3	4	5	6	7	8	9	10
Vout (V)	±5.050	±5.100	±5.150	±5.200	±5.250	±5.300	±5.350	±5.400	±5.450	±5.500
RU (k $\Omega$ )	71.844	34.422	21.948	15.711	11.969	9.474	7.692	6.356	5.316	4.484

□□D12W

$\Delta V$ (%)	1	2	3	4	5	6	7	8	9	10
Vout (V)	±12.120	±12.240	±12.360	±12.480	±12.600	±12.720	±12.840	±12.960	±13.080	±13.200
RU (k $\Omega$ )	568.197	277.598	180.732	132.299	103.239	83.866	70.028	59.650	51.577	45.120

□□D15W

$\Delta V$ (%)	1	2	3	4	5	6	7	8	9	10
Vout (V)	±15.150	±15.300	±15.450	±15.600	±15.750	±15.900	±16.050	±16.200	±16.350	±16.500
RU (k $\Omega$ )	236.249	111.625	70.083	49.312	36.850	28.542	22.607	18.156	14.694	11.925

□□D24W

$\Delta V$ (%)	1	2	3	4	5	6	7	8	9	10
Vout (V)	±24.240	±24.480	±24.720	±24.960	±25.200	±25.440	±25.680	±25.920	±26.160	±26.400
RU (k $\Omega$ )	609.713	298.357	194.571	142.678	111.543	90.786	75.959	64.839	56.190	49.271

LKC05-□□**DS**□□W

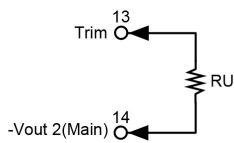

□□DS05W

$\Delta V$ (%)	1	2	3	4	5	6	7	8	9	10
Vout (V)	5.050	5.100	5.150	5.200	5.250	5.300	5.350	5.400	5.450	5.500
RU (k $\Omega$ )	252.301	125.126	82.734	61.538	48.820	40.342	34.286	29.744	26.211	23.385

□□DS12W

$\Delta V$ (%)	1	2	3	4	5	6	7	8	9	10
Vout (V)	12.120	12.240	12.360	12.480	12.600	12.720	12.840	12.960	13.080	13.200
RU (k $\Omega$ )	202.645	98.772	64.148	46.836	36.449	29.524	24.578	20.868	17.983	15.674

□□DS15W

$\Delta V$ (%)	1	2	3	4	5	6	7	8	9	10
Vout (V)	15.150	15.300	15.450	15.600	15.750	15.900	16.050	16.200	16.350	16.500
RU (k $\Omega$ )	161.024	77.962	50.275	36.431	28.125	22.587	18.632	15.665	13.358	11.512

□□DS24W

$\Delta V$ (%)	1	2	3	4	5	6	7	8	9	10
Vout (V)	24.240	24.480	24.720	24.960	25.200	25.440	25.680	25.920	26.160	26.400
RU (k $\Omega$ )	568.197	277.598	180.732	132.299	103.239	83.866	70.028	59.650	51.577	45.120

## OUTPUT VOLTAGE ADJUSTMENT(CONTINUED)

Trim-down

LKC05-□□S□□W

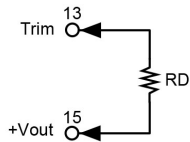

□□S3P3W

$\Delta V$ (%)	1	2	3	4	5	6	7	8	9	10
Vout (V)	3.267	3.234	3.201	3.168	3.135	3.102	3.069	3.036	3.003	2.970
RD (k $\Omega$ )	114.963	53.906	33.554	23.378	17.273	13.202	10.295	8.114	6.418	5.061

□□S05W

$\Delta V$ (%)	1	2	3	4	5	6	7	8	9	10
Vout (V)	4.950	4.900	4.850	4.800	4.750	4.700	4.650	4.600	4.550	4.500
RD (k $\Omega$ )	248.499	120.674	78.066	56.762	43.980	35.458	29.371	24.806	21.255	18.415

□□S12W

$\Delta V$ (%)	1	2	3	4	5	6	7	8	9	10
Vout (V)	11.880	11.760	11.640	11.520	11.400	11.280	11.160	11.040	10.920	10.800
RD (k $\Omega$ )	777.155	381.028	248.985	182.964	143.351	116.943	98.079	83.932	72.928	64.126

□□S15W

$\Delta V$ (%)	1	2	3	4	5	6	7	8	9	10
Vout (V)	14.850	14.700	14.550	14.400	14.250	14.100	13.950	13.800	13.650	13.500
RD (k $\Omega$ )	818.776	401.838	262.859	193.369	151.675	123.879	104.025	89.135	77.553	68.288

□□S24W

$\Delta V$ (%)	1	2	3	4	5	6	7	8	9	10
Vout (V)	23.760	23.520	23.280	23.040	22.800	22.560	22.320	22.080	21.840	21.600
RD (k $\Omega$ )	4949.803	2440.402	1603.934	1185.701	934.761	767.467	647.972	558.350	488.645	432.880

LKC05-□□D□□W

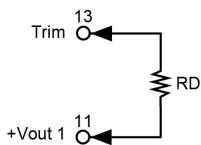

□□D05W

$\Delta V$ (%)	1	2	3	4	5	6	7	8	9	10
Vout (V)	$\pm 4.950$	$\pm 4.900$	$\pm 4.850$	$\pm 4.800$	$\pm 4.750$	$\pm 4.700$	$\pm 4.650$	$\pm 4.600$	$\pm 4.550$	$\pm 4.500$
RD (k $\Omega$ )	219.156	106.578	69.052	50.289	39.031	31.526	26.165	22.144	19.017	16.516

□□D12W

$\Delta V$ (%)	1	2	3	4	5	6	7	8	9	10
Vout (V)	$\pm 11.880$	$\pm 11.760$	$\pm 11.640$	$\pm 11.520$	$\pm 11.400$	$\pm 11.280$	$\pm 11.160$	$\pm 11.040$	$\pm 10.920$	$\pm 10.800$
RD (k $\Omega$ )	4949.803	2440.402	1603.934	1185.701	934.761	767.467	647.972	558.350	488.645	432.880

□□D15W

$\Delta V$ (%)	1	2	3	4	5	6	7	8	9	10
Vout (V)	$\pm 14.850$	$\pm 14.700$	$\pm 14.550$	$\pm 14.400$	$\pm 14.250$	$\pm 14.100$	$\pm 13.950$	$\pm 13.800$	$\pm 13.650$	$\pm 13.500$
RD (k $\Omega$ )	2707.751	1332.375	873.917	644.688	507.150	415.458	349.964	300.844	262.639	232.075

□□D24W

$\Delta V$ (%)	1	2	3	4	5	6	7	8	9	10
Vout (V)	$\pm 23.760$	$\pm 23.520$	$\pm 23.280$	$\pm 23.040$	$\pm 22.800$	$\pm 22.560$	$\pm 22.320$	$\pm 22.080$	$\pm 21.840$	$\pm 21.600$
RD (k $\Omega$ )	11244.29	5555.643	3659.429	2711.322	2142.457	1763.214	1492.327	1289.161	1131.143	1004.729

**OUTPUT VOLTAGE ADJUSTMENT(CONTINUED)**

Trim-down

LKC05-□□DS□□W

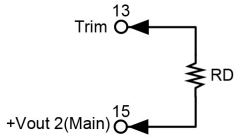

□□DS05W

$\Delta V$ (%)	1	2	3	4	5	6	7	8	9	10
Vout (V)	4.950	4.900	4.850	4.800	4.750	4.700	4.650	4.600	4.550	4.500
RD (k $\Omega$ )	248.499	120.674	78.066	56.762	43.980	35.458	29.371	24.806	21.255	18.415

□□DS12W

$\Delta V$ (%)	1	2	3	4	5	6	7	8	9	10
Vout (V)	11.880	11.760	11.640	11.520	11.400	11.280	11.160	11.040	10.920	10.800
RD (k $\Omega$ )	777.155	381.028	248.985	182.964	143.351	116.943	98.079	83.932	72.928	64.126

□□DS15W

$\Delta V$ (%)	1	2	3	4	5	6	7	8	9	10
Vout (V)	14.850	14.700	14.550	14.400	14.250	14.100	13.950	13.800	13.650	13.500
RD (k $\Omega$ )	818.776	401.838	262.859	193.369	151.675	123.879	104.025	89.135	77.553	68.288

□□DS24W

$\Delta V$ (%)	1	2	3	4	5	6	7	8	9	10
Vout (V)	23.760	23.520	23.280	23.040	22.800	22.560	22.320	22.080	21.840	21.600
RD (k $\Omega$ )	4949.803	2440.402	1603.934	1185.701	934.761	767.467	647.972	558.350	488.645	432.880