

AP5/AP10 Relays

Product Facts

- AP5 make and break 5 A; AP10 make and break 10 A @ 270 Vdc
- 20 A overload rating
- Latching actuator available for low power consumption
- Ideal for applications from 28 to 1000 Vdc
- Small size and weight
- Wide variety of mounting styles (see pages 54 and 55)
- No heat sinks required
- 2000 V isolation across open contacts
- Vacuum-sealed contacts; can operate in harsh environments
- Qualified to SAE ARD 50031
- Space-rated version built in accordance with customers SCD

Notes:

*The load terminals should always be connected as follows: Common Contact +; Other Contact -.
 **10 amps for PC board connection.

Coil Data

Volts, Nominal	12	28	28 ²	120
Pickup, Max. ¹	10 Vdc	20 Vdc	16 Vdc	85 Vdc
Dropout, Min.	.3-6 Vdc	.7-12 Vdc	N/A	5-55 Vdc
Coil Resistance (±10%)	53 Ω	290 Ω	80 Ω	4700 Ω

Coil resistance rated at 25°C

Notes:

1. Value for AP5C is 24 for 28 Vdc coil & 100 for 120 Vdc coil
2. Latching

For factory-direct application assistance, dial 800-253-4560, ext. 2055, or 805-220-2055.

AP5A, AP5B, & AP5C Relays — 5 Amps

Product Specifications

Contact Arrangement —

AP5A — SPST-NO

AP5B — SPST-NC

AP5C — SPDT

Contact Form —

AP5A — A

AP5B — B

AP5C — C

Rated Resistive Load @ 270 Vdc — 5 A*

Continuous Current Carry, Max. —

AP5A, AP5B, AP5C — 25 A**

Overload @ 270 Vdc —

AP5A, AP5B — 20 A

AP5C — 10 A

Contact Resistance, Max. —

10 mohm

Dielectric at Sea Level —

Coil to Case — 500 Vrms

All Other Points — 2,000 Vrms

Shock, 11ms, 1/2 Sine (Peak) —

AP5A, AP5B, AP5C — 50 g

Vibration, Sinusoidal (55-2000 Hz, Peak) —

10 g

Operating Ambient Temperature Range —

-55°C to +85°C

Load Life @ 270 Vdc, Min. —

AP5A, AP5B — 50,000 cycles

AP5C — 10,000 cycles

Operate Time, Excluding Bounce, Max. —

AP5A, AP5B, AP5C — 7 ms

Release Time, Max. —

AP5A, AP5B, AP5C — 10 ms

Bounce Time, Max. —

AP5A, AP5B, AP5C — 3 ms

Insulation Resistance @ 500 Vdc, Min. —

Initial — 100 mohm

End of Life — 50 mohm

Weight, Nominal —

28 gram (1 oz.)

AP10A, AP10B, AP10P & AP11A Relays — 10 Amps

Product Specifications

Contact Arrangement —

AP10A — SPST-NO

AP10B — SPST-NC

AP10P — SPST Latching

Contact Form —

AP10A — A

AP10B — B

AP10P — P

Rated Resistive Load @ 270 Vdc — 10 A*

Continuous Current Carry, Max. —

AP10A, AP10B — 25 A**

AP10P — 30 A**

Overload @ 270 Vdc —

20 A

Contact Resistance, Max. —

10 mohm

Dielectric at Sea Level —

Coil to Case — 500 Vrms

All Other Points — 2,000 Vrms

Shock, 11ms, 1/2 Sine (Peak) —

50 g

Vibration, Sinusoidal (55-2000 Hz, Peak) —

10 g

Operating Ambient Temperature Range —

-55°C to +85°C

Load Life @ 270 Vdc, Min. —

AP10A — 10,000 cycles

AP10B, AP10P — 7,000 cycles

Operate Time, Excluding Bounce, Max. —

AP10A, AP10B — 7 ms

AP10P — 4 ms

Release Time, Max. —

AP10A, AP10B — 10 ms

AP10P — N/A

Bounce Time, Max. —

AP10A, AP10B — 3 ms

AP10P — 2 ms

Insulation Resistance @ 500 Vdc, Min. —

Initial — 100 mohm

End of Life — 50 mohm

Weight, Nominal —

28 gram (1 oz.)

Ordering Information

Sample Part Number ▶

Series: _____

Contact Form: _____

A = SPST-NO B = SPST-NC C = SPDT

P = SPST Latching

Coil Voltage: _____

2 = 12Vdc, Bus Wire/PC Board

3 = 28 Vdc, Bus Wire/PC Board

5 = 120 Vdc, Bus Wire/PC Board

7 = 12 Vdc, Turret Terminals

8 = 28 Vdc, Turret Terminals

9 = 120 Vdc, Turret Terminals

A = 12 Vdc, Stud Terminals, Panel Mount

B = 28 Vdc, Stud Terminals, Panel Mount

C = 120 Vdc, Stud Terminals, Panel Mount

Power Terminals: _____

3 = Solder Connection/PC Board

4 = Flying Leads

5 = Stud Terminals, Panel Mount

Mounting: _____

2 = Flanged Mount

4 = Through Chassis Mount

5 = PCB Mount

7 = Panel Mount

AP5 C 3 4 5

7
 KILOVAC 270+ Vdc
 High Voltage Relays

AP5/AP10 Relays (Continued)

Through chassis style mounting with solder type power terminals and turret coil terminals (Available in forms A, B, & C)



AP5A834 Shown as Part Number Sample

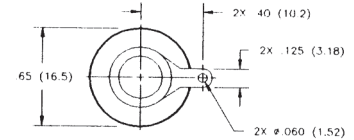
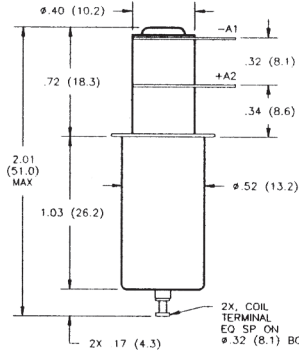

Through chassis style mounting with solder type power terminals and bus wire coil leads (Available in forms A, B, C, P)

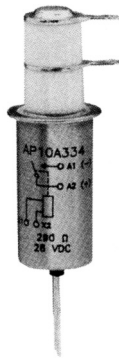

AP10A334 Shown as Part Number Sample

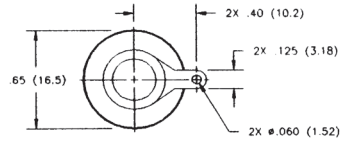
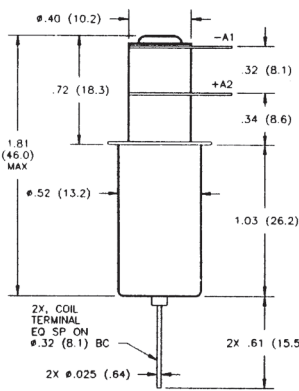

Flanged style mounting with solder type power terminals and turret coil terminals (Available in forms A, B, & C)

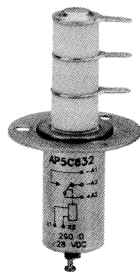

AP5C832 Shown as Part Number Sample

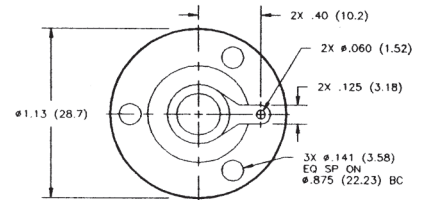
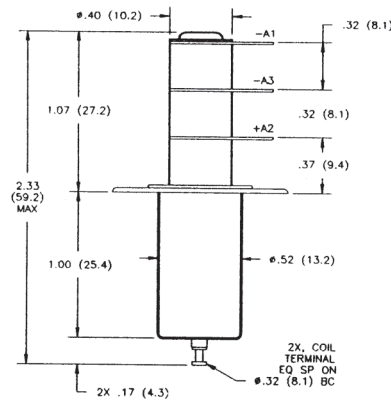

Flanged style mounting with solder type power terminals and bus wire coil leads (Available in forms A, B, C, P)

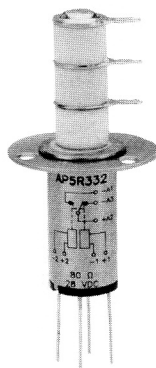

AP5R332 Shown as Part Number Sample

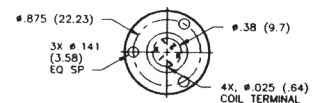
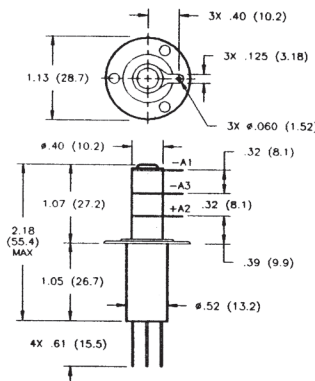

For factory-direct application assistance, dial 800-253-4560, ext. 2055, or 805-220-2055.

AP5/AP10 Relays (Continued)

PC board style mounting with PC board terminals (Available in forms A, B, & C)

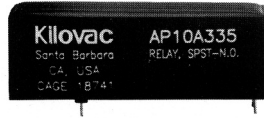

AP10A335 Shown as Part Number Sample

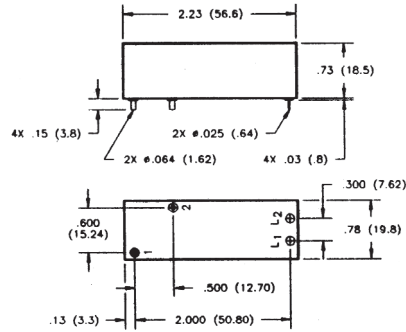

Panel style mounting with flying power leads and stud terminals (Available in forms A & B)

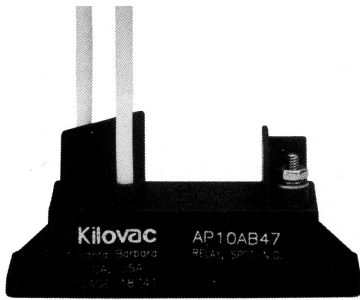

AP10AB47 Shown as Part Number Sample

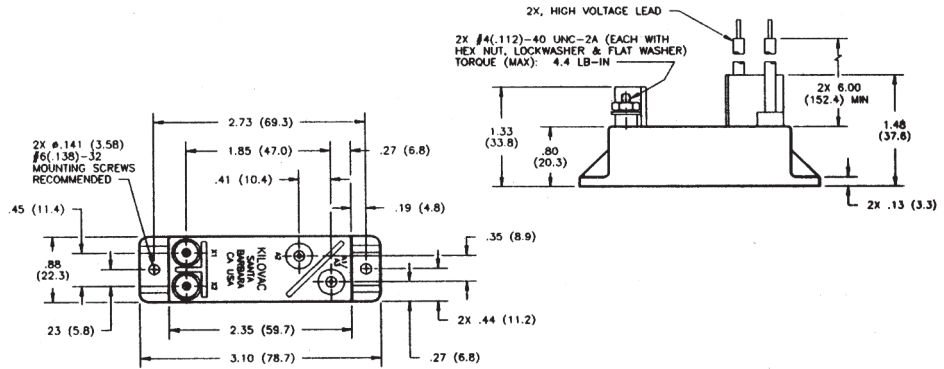

Panel style mounting with stud terminals (Available in forms A & B)



AP10AB57 Shown as Part Number Sample

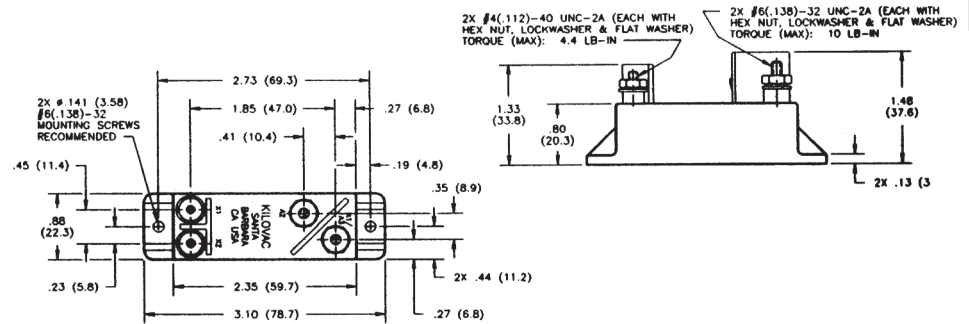

For factory-direct application assistance, dial 800-253-4560, ext. 2055, or 805-220-2055.