

RO3156E

**868.950 MHz
SAW Resonator**

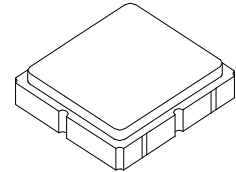

SM3030-6 3 x 3 mm Case

- **Designed for European 868.95 MHz SRD Transmitters**
- **Very Low Series Resistance**
- **Quartz Stability**
- **Complies with Directive 2002/95/EC (RoHS)**
- **Moisture Sensitivity Level: 1**
- **AEC-Q200 Qualified**

The RO3156E is a true one-port, surface-acoustic-wave (SAW) resonator in a surface-mount ceramic case. It provides reliable, fundamental-mode, quartz frequency stabilization of fixed-frequency transmitters operating at 868.95 MHz. This SAW is designed specifically for SRD remote control and wireless security transmitters operating under ETSI EN 300 220.

Absolute Maximum Ratings

Rating	Value	Units
Input Power Level	0	dBm
DC Voltage	12	VDC
Storage Temperature	-40 to +125	°C
Operating Temperature Range	-40 to +125	°C
Soldering Temperature, 10 seconds / 5 cycles maximum	+260	°C

Electrical Characteristics

Characteristic	Sym	Notes	Minimum	Typical	Maximum	Units
Frequency, +25 °C	RO3156E RO3156E-1 RO3156E-2	f_c	868.750		869.150	MHz
			868.800		869.100	
			868.850		869.050	
Tolerance from 868.95 MHz	RO3156E RO3156E-1 RO3156E-2	Δf_c			±200	kHz
					±150	
					±100	
Insertion Loss	IL			1.2	2.0	dB
Quality Factor	Unloaded Q	Q_U		6700		
	50 Ω Loaded Q	Q_L		800		
Temperature Stability	Turnover Temperature	T_O	10	25	40	°C
	Turnover Frequency	f_O		f_c		kHz
	Frequency Temperature Coefficient	FTC		0.032		ppm/°C ²
Frequency Aging	Absolute Value during the First Year	fA		<±10		ppm/yr
DC Insulation Resistance between Any Two Terminals			1.0			M Ω
RF Equivalent RLC Model	Motional Resistance	R_M		14.1		Ω
	Motional Inductance	L_M		17.2		μ H
	Motional Capacitance	C_M		2.0		fF
	Shunt Static Capacitance	C_O		2.3		pF
Test Fixture Shunt Inductance	L_{TEST}			14.6		nH
Lid Symbolization (Y = Year, WW = Week, S = Shift)				708, YWWS		
Standard Reel Quantity	Reel Size 7 Inch	10	500 Pieces / Reel			
	Reel Size 13 Inch		3000 Pieces / Reel			



CAUTION: Electrostatic Sensitive Device. Observe precautions for handling.

NOTES:

1. The design, manufacturing process, and specifications of this device are subject to change.
2. US or International patents may apply.
3. RoHS compliant from the first date of manufacture.

Electrical Connections

The SAW resonator is bidirectional and may be installed with either orientation. The two terminals are interchangeable and unnumbered. The callout NC indicates no internal connection. The NC pads assist with mechanical positioning and stability. External grounding of the NC pads is recommended to help reduce

Pin	Connection
1	NC
2	Terminal
3	NC
4	NC
5	Terminal

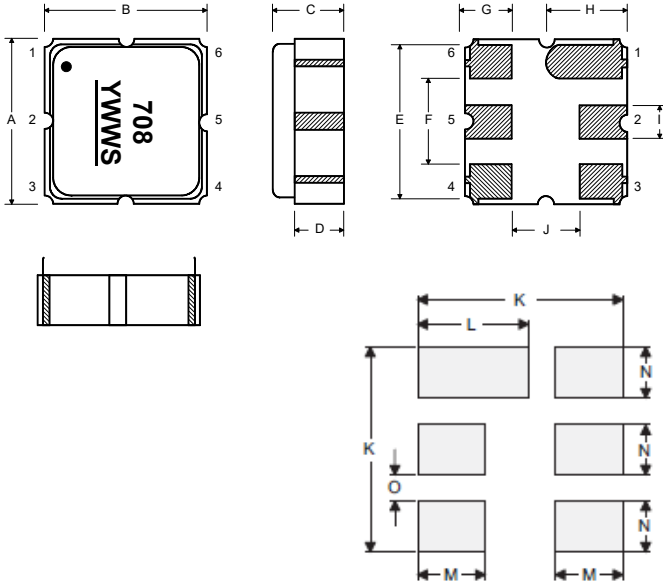

Temperature Characteristics

The curve shown accounts for resonator

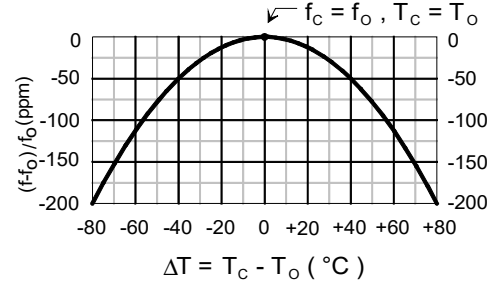

Characterization Test Circuit

Inductor L_{TEST} is tuned to resonate with the static capacitance, C_0 , at F_c .

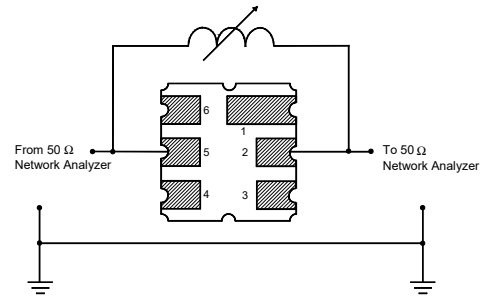

Power Dissipation Test

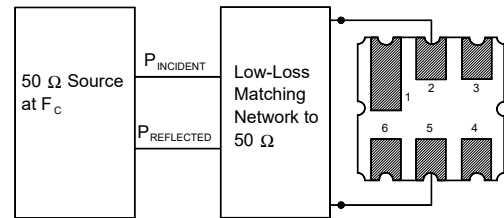

Case and Typical PCB Land Dimensions

Ref	mm			Inches		
	Min	Nom	Max	Min	Nom	Max
A	2.87	3.00	3.13	0.113	0.118	0.123
B	2.87	3.00	3.13	0.113	0.118	0.123
C	1.12	1.25	1.38	0.044	0.049	0.054
D	0.77	0.90	1.03	0.030	0.035	0.040
E	2.67	2.80	2.93	0.105	0.110	0.115
F	1.47	1.60	1.73	0.058	0.063	0.068
G	0.72	0.85	0.98	0.028	0.033	0.038
H	1.37	1.50	1.63	0.054	0.059	0.064
I	0.47	0.60	0.73	0.019	0.024	0.029
J	1.17	1.30	1.43	0.046	0.051	0.056
K		3.20			0.126	
L		1.70			0.067	
M		1.05			0.041	
N		0.81			0.032	
O		0.38			0.015	

Equivalent RLC Model

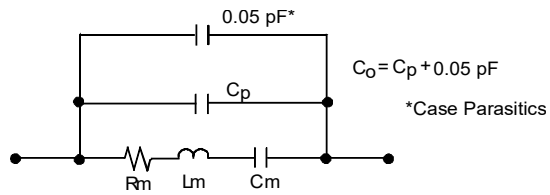

Example Application Circuits

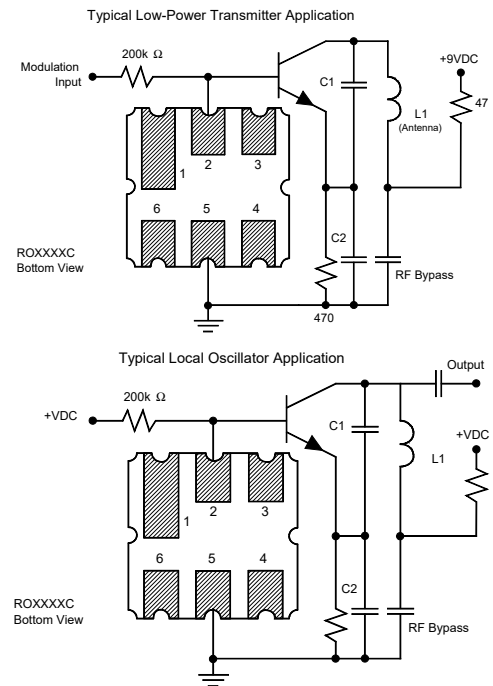

Recommended Reflow Profile

1. Preheating shall be fixed at 150~180°C for 60~90 seconds.
2. Ascending time to preheating temperature 150°C shall be 30 seconds min.
3. Heating shall be fixed at 220°C for 50~80 seconds and at 260°C +0/-5°C peak (10 seconds).
4. Time: 5 times maximum.

