

**SERIES:** PYBE30 | **DESCRIPTION:** DC-DC CONVERTER

**FEATURES**

- up to 30 W isolated output
- industry standard pin-out
- 4:1 input range (9~36 Vdc, 18~75 Vdc)
- single/dual regulated outputs
- 1500 Vdc isolation
- continuous short circuit protection
- efficiency up to 90%
- operating temperature range (-40~+80°C)
- EN/BS EN 62368-1



MODEL	input voltage		output voltage (Vdc)	output current		output power max (W)	ripple & noise <sup>1</sup> max (mVp-p)	efficiency <sup>2</sup> typ (%)
	typ (Vdc)	range (Vdc)		min (mA)	max (mA)			
PYBE30-Q24-S3 <sup>4</sup>	24	9~36	3.3	0	6000	19.8	100	85
PYBE30-Q24-S5 <sup>4</sup>	24	9~36	5	0	6000	30	100	86
PYBE30-Q24-S9 <sup>3,4</sup>	24	9~36	9	0	3333	30	100	88
PYBE30-Q24-S12 <sup>4</sup>	24	9~36	12	0	2500	30	100	90
PYBE30-Q24-S15 <sup>4</sup>	24	9~36	15	0	2000	30	100	90
PYBE30-Q24-S24 <sup>4</sup>	24	9~36	24	0	1250	30	100	90
PYBE30-Q24-D5 <sup>3,4</sup>	24	9~36	±5	0	±3000	30	150	86
PYBE30-Q24-D12 <sup>3,4</sup>	24	9~36	±12	0	±1250	30	150	89
PYBE30-Q24-D15 <sup>3,4</sup>	24	9~36	±15	0	±1000	30	150	89
PYBE30-Q24-D24 <sup>3,4</sup>	24	9~36	±24	0	±625	30	150	89
PYBE30-Q48-S3	48	18~75	3.3	0	6000	19.8	100	86
PYBE30-Q48-S5	48	18~75	5	0	6000	30	100	87
PYBE30-Q48-S12	48	18~75	12	0	2500	30	100	88
PYBE30-Q48-S15	48	18~75	15	0	2000	30	100	89
PYBE30-Q48-S24	48	18~75	24	0	1250	30	100	87
PYBE30-Q48-D5 <sup>3</sup>	48	18~75	±5	0	±3000	30	150	86
PYBE30-Q48-D12 <sup>3</sup>	48	18~75	±12	0	±1250	30	150	88
PYBE30-Q48-D15 <sup>3</sup>	48	18~75	±15	0	±1000	30	150	88

- Notes:
1. From 5~100% load, nominal input, 20 MHz bandwidth oscilloscope, with 10 µF tantalum and 1 µF ceramic capacitors on the output. From 0~5% load, ripple and noise is <5% Vo.
  2. Measured at nominal input voltage, full load. The typical efficiencies for the chassis mount and DIN-rail mount versions are ~2% less than the board mount versions due to the input reverse polarity protection.
  3. Model is not UL certified.
  4. Model is not CE or UKCA certified.
  5. All specifications are measured at Ta=25°C, humidity < 75%, nominal input voltage, and rated output load unless otherwise specified.

## PART NUMBER KEY

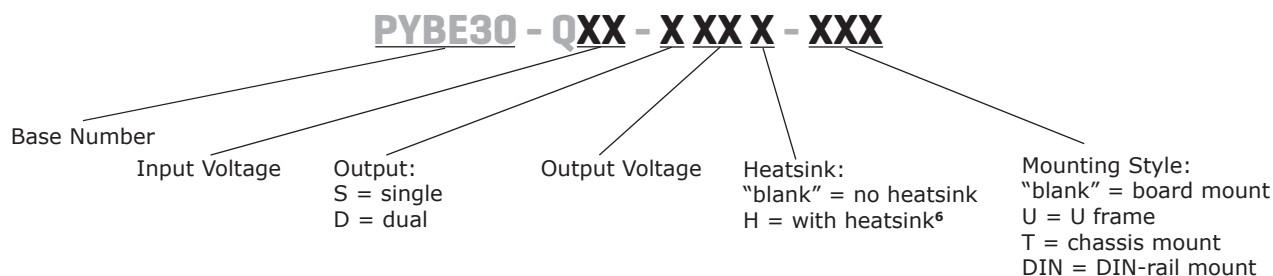

Notes: 6. Heatsink is not available for U-frame options.

## INPUT

parameter	conditions/description	min	typ	max	units
operating input voltage <sup>7</sup>	24 Vdc input models	9	24	36	Vdc
	48 Vdc input models	18	48	75	Vdc
start-up voltage <sup>7</sup>	24 Vdc input models			9	Vdc
	48 Vdc input models			18	Vdc
surge voltage	for maximum of 1 second				
	24 Vdc input models	-0.7		50	Vdc
	48 Vdc input models	-0.7		100	Vdc
under voltage shutdown	24 Vdc input models	5.5	6.5		Vdc
	48 Vdc input models	12.0	15.5		Vdc
current (full load/no load)	24 Vdc input models			994/100	mA
		3.3 Vdc output models		1488/100	mA
		5 Vdc output models		1488/16	MA
		all other models			
	48 Vdc input models			491/30	mA
		3.3 Vdc output models		735/35	mA
		5 Vdc output models		744/10	mA
		all other models			
remote on/off (CTRL) <sup>8</sup>	turn on (3.5~12 Vdc or open circuit) turn off (<1.2 Vdc) input current when switched off		5	8	mA
filter	Pi filter				
input reverse polarity protection	only present on chassis mount and DIN-rail mount models				

Notes: 7. The minimum input voltage and start-up voltage for the chassis mount and DIN-rail mount versions are 1 Vdc higher than the board mount versions.  
8. The voltage of the CTRL pin is referenced to input GND pin.

## OUTPUT

parameter	conditions/description	min	typ	max	units
maximum capacitive load <sup>9</sup>	3.3, 5 Vdc output models			10,000	µF
	9 Vdc output models			4,700	µF
	12 Vdc output models			2,700	µF
	15 Vdc output models			1,680	µF
	±5 Vdc output models			2,000	µF
	±12 Vdc output models			1,250	µF
	24, ±15 Vdc output models			680	µF
	±24 Vdc output models			470	µF
voltage accuracy <sup>10</sup>	0% to 5% load		±1	±5	%
	5% to full load		±1	±3	%
line regulation	from low line to high line, full load				
	positive outputs		±0.2	±0.5	%
	negative outputs		±0.5	±1	%
load regulation <sup>11</sup>	from 5% to full load				
	positive outputs		±0.5	±1	%
	negative outputs		±0.5	±1.5	%

Note: 9. Tested at input voltage range and full load.  
10. At 0~5% load, the max output voltage accuracy for the ±5 & ±9 Vdc output models is ±5%.  
11. At 0~100% load, the max load regulation is ±5%.

**OUTPUT (CONTINUED)**

parameter	conditions/description	min	typ	max	units
cross regulation	dual output models: main output 50% load secondary output from 10~100% load			±5	%
start-up time	nominal input, constant resistive load		10		ms
adjustability <sup>12</sup>	see application notes		±10		%
switching frequency <sup>13</sup>	PWM mode		300		kHz
transient recovery time	25% load step change, nominal input voltage		300	500	µs
transient response deviation	25% load step change, nominal input voltage 3.3, 5, ±5 Vdc output models all other models		±5 ±3	±8 ±5	% %
temperature coefficient	at full load			±0.03	%/°C

Note: 12. For single output models only

13. Value is based on full load. At loads &lt;50%, the switching frequency decreases with decreasing load.

**PROTECTIONS**

parameter	conditions/description	min	typ	max	units
over voltage protection		110		160	%
over current protection		110		190	%
short circuit protection	hiccup, continuous, self recovery				

**SAFETY AND COMPLIANCE**

parameter	conditions/description	min	typ	max	units
isolation voltage	input to output for 1 minute at 1 mA	1,500			Vdc
isolation resistance	input to output at 500 Vdc	1,000			MΩ
isolation capacitance	input to output, 100 kHz / 0.1 V		2,000		pF
safety approvals <sup>14</sup>	certified to 62368-1: EN, BS EN certified to 60950: UL				
conducted emissions	CISPR32/EN55032, class A (no external circuit); class B (external circuit required, see Figure 3-b, 4-b)				
radiated emissions	CISPR32/EN55032, class A (no external circuit); class B (external circuit required, see Figure 3-b, 4-b)				
ESD	IEC/EN61000-4-2, contact ± 4kV, class B				
radiated immunity	IEC/EN61000-4-3, 10V/m, class A				
EFT/burst	IEC/EN61000-4-4, ± 2kV, class B (external circuit required, see Figure 3-a, 4-a)				
surge	IEC/EN61000-4-5, line-line ± 2kV, class B (external circuit required, see Figure 3-a, 4-a)				
conducted immunity	IEC/EN61000-4-6, single output, 3 Vr.m.s, class A IEC/EN61000-4-6, dual output, 10 Vr.m.s, class A				
MTBF	as per MIL-HDBK-217F, 25°C	1,000,000			hours
RoHS	yes				

Note: 14. For UL certified models, please refer to the model table.

## ENVIRONMENTAL

parameter	conditions/description	min	typ	max	units
operating temperature	see derating curves	-40		80	°C
storage temperature		-55		125	°C
storage humidity	non-condensing	5		95	%
vibration	10~55 Hz, for 30 minutes on each axis		10		G

## DERATING CURVES

**TEMPERATURE DERATING CURVE  
(dual output)**

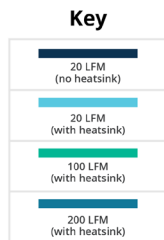
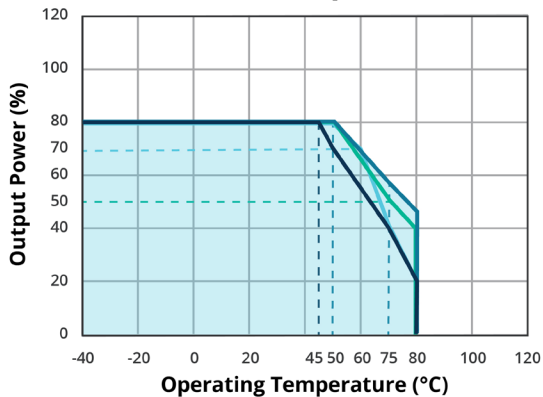

**TEMPERATURE DERATING CURVE  
(dual output)**

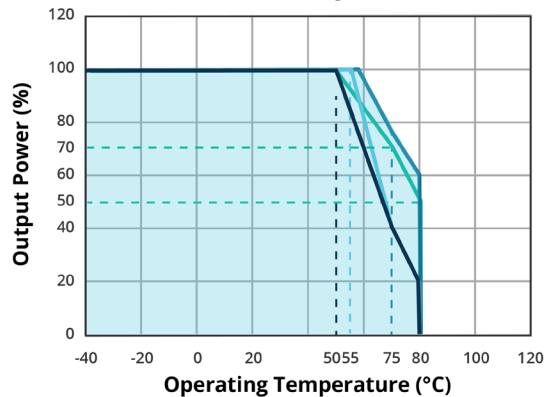

Applicable models:  
 PYBE30-Q24-D5 (9-18 Vdc input voltage),  
 PYBE30-Q24-D24 (9-18 Vdc input voltage),  
 PYBE30-Q48-D5 (18-36 Vdc input voltage)

Applicable models:  
 PYBE30-Q24-D5 (18-36 Vdc input voltage),  
 PYBE30-Q24-D24 (18-36 Vdc input voltage),  
 PYBE30-Q48-D5 (36-75 Vdc input voltage),  
 PYBE30-Q24-D12, PYBE30-Q24-D15,  
 PYBE30-Q48-D12, PYBE30-Q48-D15

**TEMPERATURE DERATING CURVE  
(single output)**

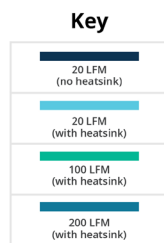
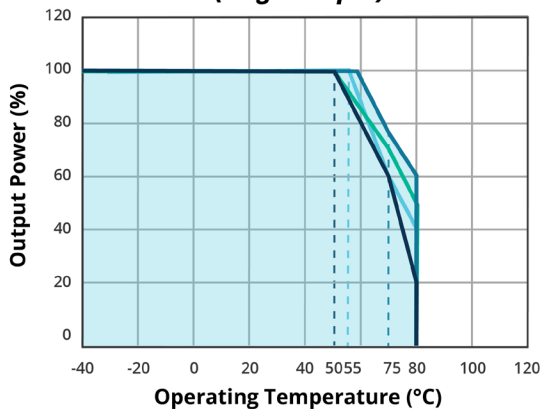

**TEMPERATURE DERATING CURVE  
(single output)**

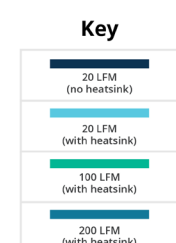
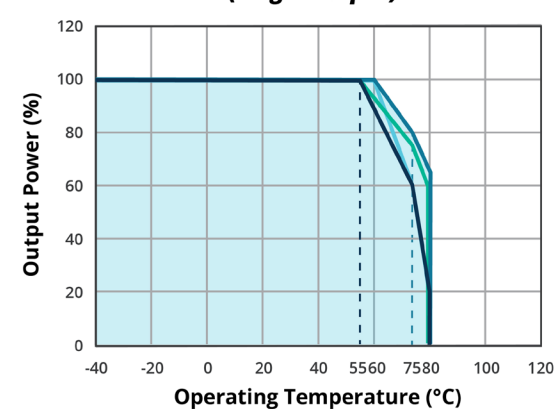

Applicable models:  
 PYBE30-Q24-S3, PYBE30-Q24-S5,  
 PYBE30-Q48-S3, PYBE30-Q48-S5

Applicable models:  
 PYBE30-Q24-S9, PYBE30-Q24-S12,  
 PYBE30-Q24-S15, PYBE30-Q24-S24,  
 PYBE30-Q48-S12, PYBE30-Q48-S15,  
 PYBE30-Q48-S24

## EFFICIENCY CURVES

**EFFICIENCY VS INPUT VOLTAGE**  
(full load)  
**PYBE30-Q24-S5**

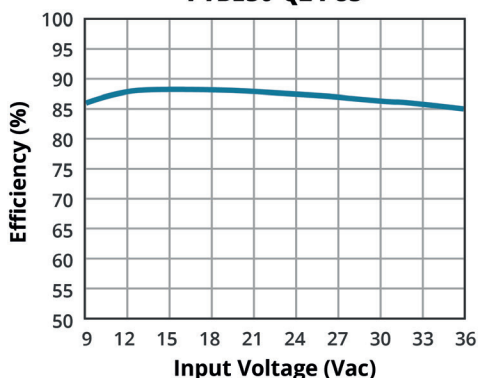

**EFFICIENCY VS OUTPUT LOAD**  
(Vin = 24V)  
**PYBE30-Q24-S5**

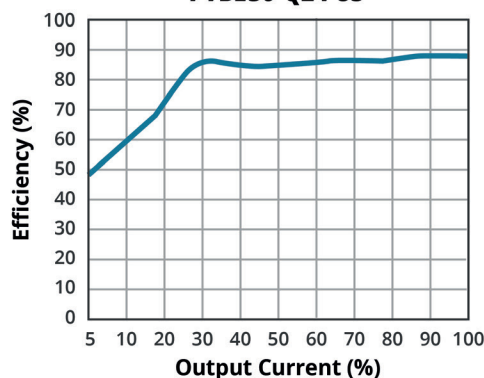

**EFFICIENCY VS INPUT VOLTAGE**  
(full load)  
**PYBE30-Q48-D15**

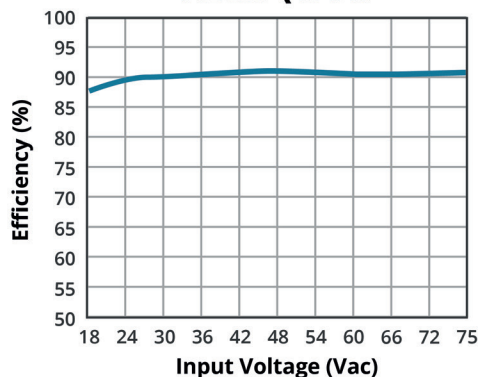

**EFFICIENCY VS OUTPUT LOAD**  
(Vin = 48V)  
**PYBE30-Q48-D15**

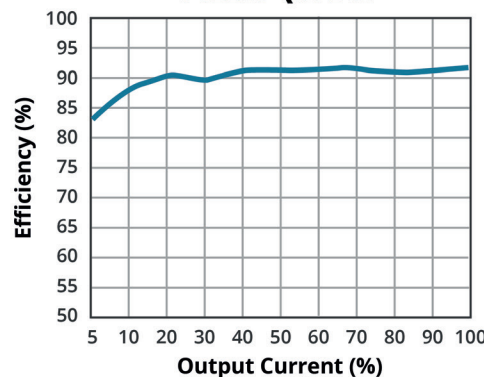

## SOLDERABILITY<sup>15</sup>

parameter	conditions/description	min	typ	max	units
hand soldering	1.5 mm from case for 10 seconds			300	°C

Note: 15. For board mount models only.

## MECHANICAL

parameter	conditions/description	min	typ	max	units
dimensions	board mount: 50.80 x 25.40 x 11.80 [2.000 x 1.000 x 0.465 inch]				mm
	board mount with heatsink: 51.40 x 26.20 x 16.50 [2.024 x 1.031 x 0.650 inch]				mm
	U-frame mount: 55.00 x 52.30 x 19.00 [2.165 x 2.059 x 0.748 inch]				mm
	chassis mount: 76.00 x 31.50 x 21.20 [2.992 x 1.240 x 0.835 inch]				mm
	chassis mount with heatsink: 76.00 x 31.50 x 25.30 [2.992 x 1.240 x 0.996 inch]				mm
	DIN-rail mount: 76.00 x 31.50 x 25.80 [2.992 x 1.240 x 1.016 inch]				mm
case material	DIN-rail mount with heatsink: 76.00 x 31.50 x 29.90 [2.992 x 1.240 x 1.177 inch]				mm
	aluminum alloy				
weight	board mount		26		g
	board mount with heatsink		37		g
	U-frame mount		59		g
	chassis mount		48		g
	chassis mount with heatsink		60		g
	DIN-rail mount		68		g
DIN-rail mount with heatsink		80		g	

## MECHANICAL DRAWING (BOARD MOUNT)

units: mm [inch]  
 tolerance:  $\pm 0.50[\pm 0.020]$   
 pin diameter tolerance:  $\pm 0.10[\pm 0.004]$

PIN CONNECTIONS		
PIN	Function	
	Single	Dual
1	Vin	Vin
2	GND	GND
3	CTRL	CTRL
4	trim	-Vo
5	0V	0V
6	+Vo	+Vo

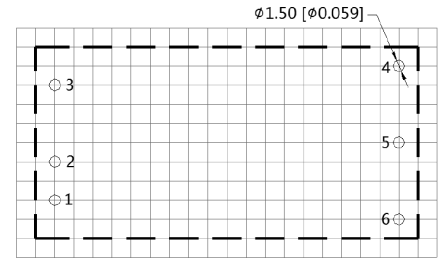
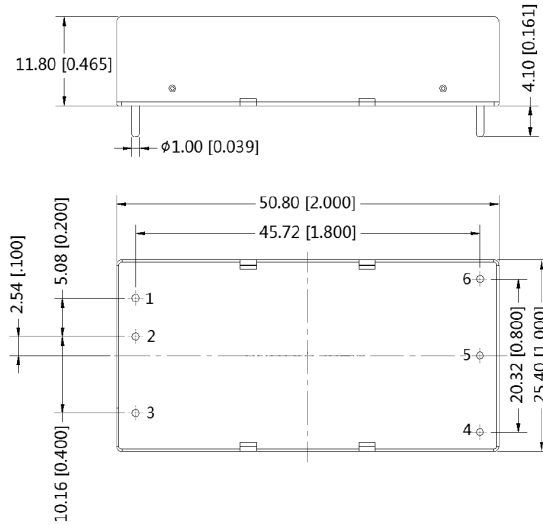

Note : Grid 2.54\*2.54mm  
 Recommended PCB Layout  
 Top View

## MECHANICAL DRAWING (BOARD MOUNT WITH HEATSINK)

units: mm [inch]  
 tolerance:  $\pm 0.50[\pm 0.020]$   
 pin diameter tolerance:  $\pm 0.10[\pm 0.004]$

PIN CONNECTIONS		
PIN	Function	
	Single	Dual
1	Vin	Vin
2	GND	GND
3	CTRL	CTRL
4	trim	-Vo
5	0V	0V
6	+Vo	+Vo

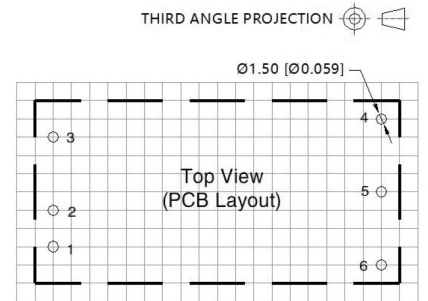
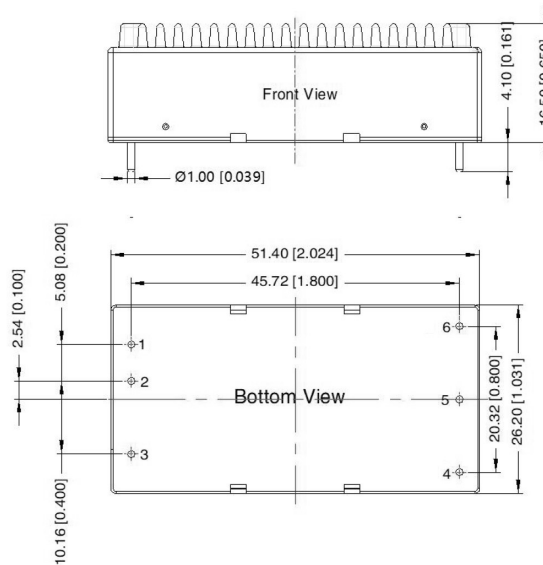

Note: Grid 2.54\*2.54mm

## MECHANICAL DRAWING (U-FRAME MOUNT)

units: mm [inch]  
 wire range: 24~12 AWG  
 tightening torque: Max 0.4 N·m  
 tolerance: ±1.00[±0.039]

PIN CONNECTIONS		
PIN	Function	
	Single	Dual
1	GND	GND
2	Vin	Vin
3	CTRL	CTRL
4	Case	Case
5	NC	NC
6	+Vo	+Vo
7	0V	0V
8	trim	-Vo

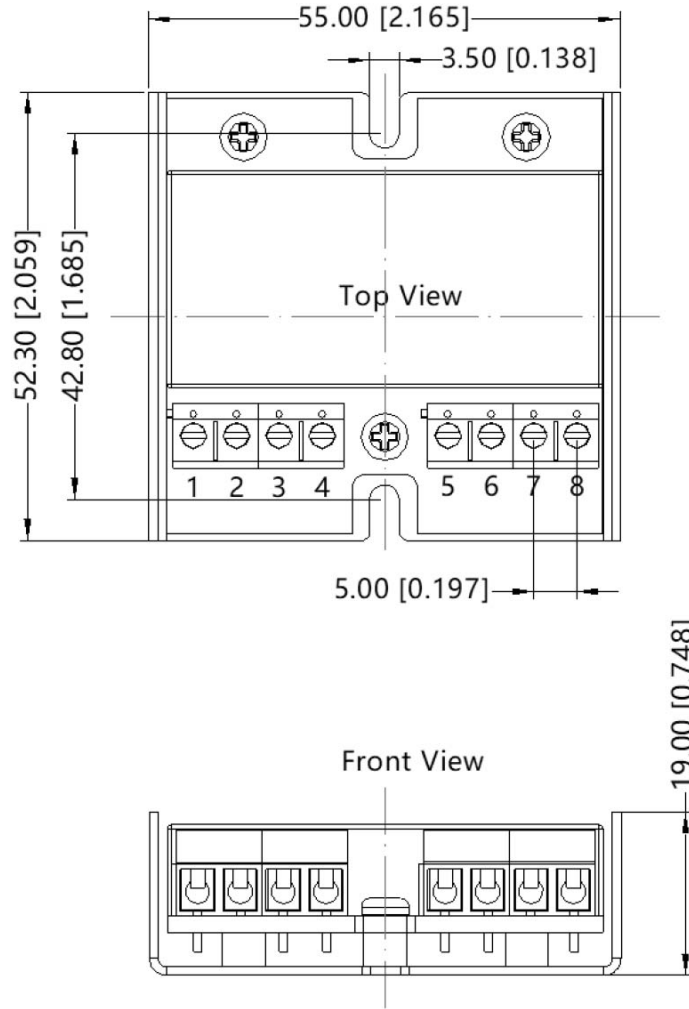

## MECHANICAL DRAWING (CHASSIS MOUNT)

units: mm [inch]  
tolerance:  $\pm 0.50$  [ $\pm 0.020$ ]

wire range: 24~12 AWG  
tightening torque: max 0.4 N·m

PIN CONNECTIONS		
PIN	Function	
	Single	Dual
1	CTRL	CTRL
2	GND	GND
3	Vin	Vin
4	trim	-Vo
5	0V	0V
6	+Vo	+Vo

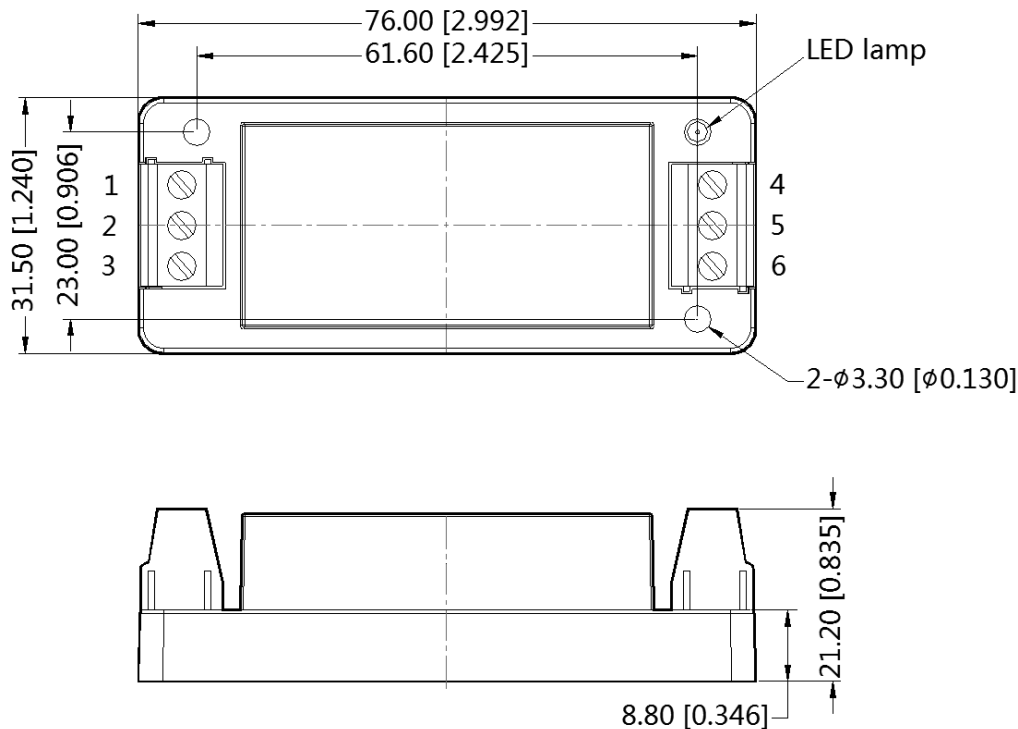

## MECHANICAL DRAWING (CHASSIS MOUNT WITH HEATSINK)

units: mm [inch]  
tolerance:  $\pm 1.00$  [ $\pm 0.039$ ]

wire range: 24~12 AWG  
tightening torque: max 0.4 N·m

PIN CONNECTIONS		
PIN	Function	
	Single	Dual
1	CTRL	CTRL
2	GND	GND
3	Vin	Vin
4	+Vo	+Vo
5	0V	0V
6	trim	-Vo

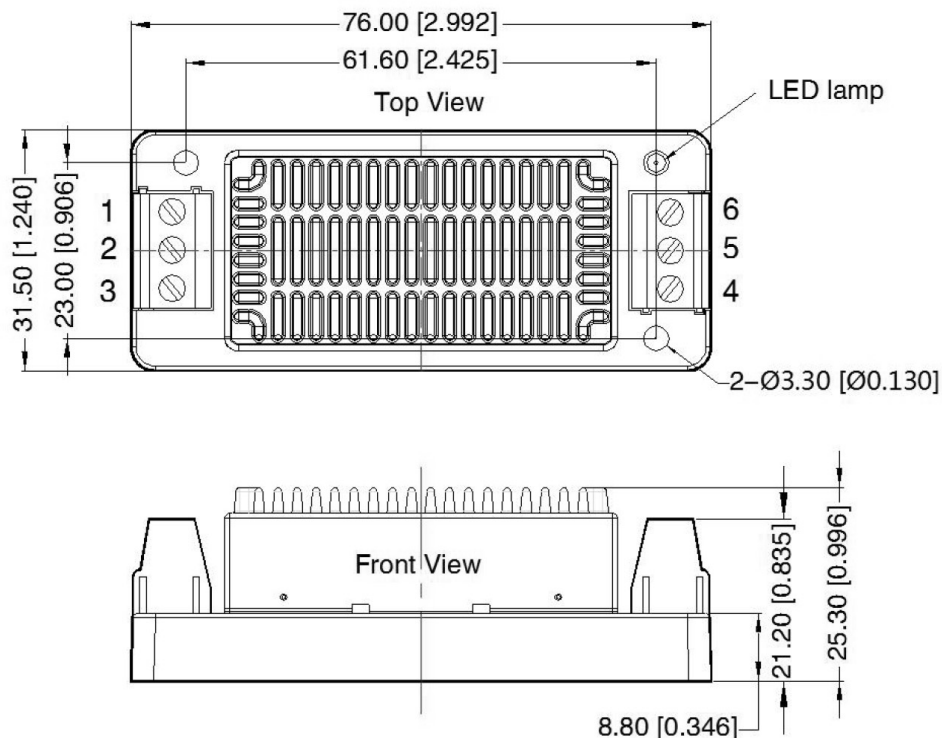



## MECHANICAL DRAWING (DIN-RAIL MOUNT)

units: mm [inch]  
tolerance:  $\pm 0.50[\pm 0.020]$

installed on DIN rail TS35  
wire range: 24~12 AWG  
tightening torque: max 0.4 N·m

PIN CONNECTIONS		
PIN	Function	
	Single	Dual
1	CTRL	CTRL
2	GND	GND
3	Vin	Vin
4	trim	-Vo
5	0V	0V
6	+Vo	+Vo

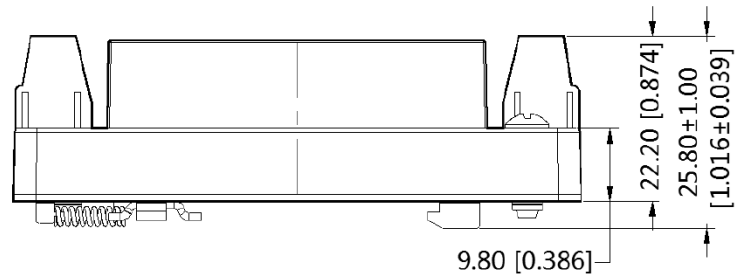
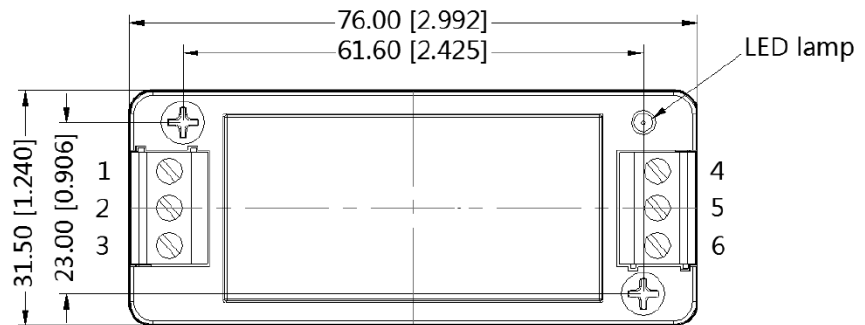

## MECHANICAL DRAWING (DIN-RAIL MOUNT WITH HEATSINK)

units: mm [inch]  
tolerance:  $\pm 1.00[\pm 0.039]$

installed on DIN rail TS35  
wire range: 24~12 AWG  
tightening torque: max 0.4 N·m

PIN CONNECTIONS		
PIN	Function	
	Single	Dual
1	CTRL	CTRL
2	GND	GND
3	Vin	Vin
4	+Vo	+Vo
5	0V	0V
6	trim	-Vo

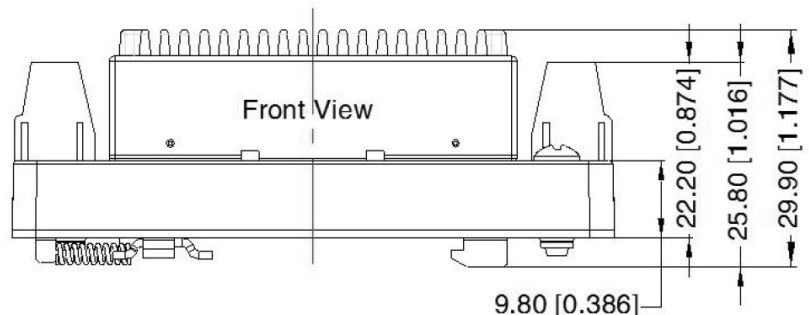
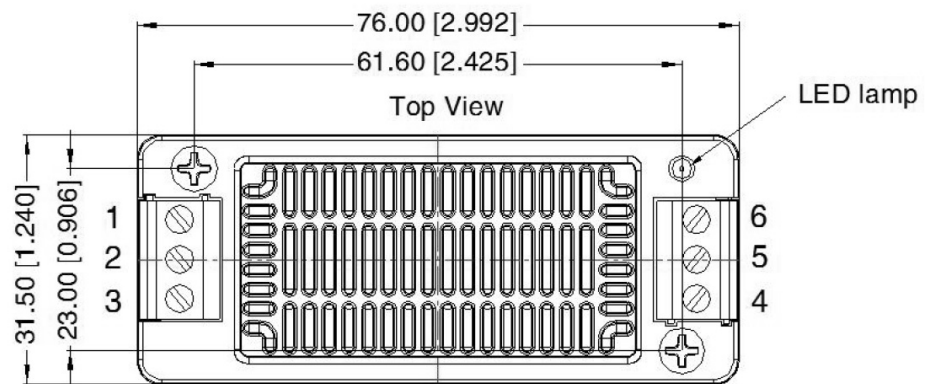

## APPLICATION CIRCUIT

This series has been tested according to the following recommended circuits (Figures 1 & 2) before leaving the factory. If you want to further reduce the input and output ripple, you can increase the input and output capacitors or select capacitors of low equivalent impedance provided that the capacitance is less than the maximum capacitive load of the model.

**Figure 1**  
Single Output Models

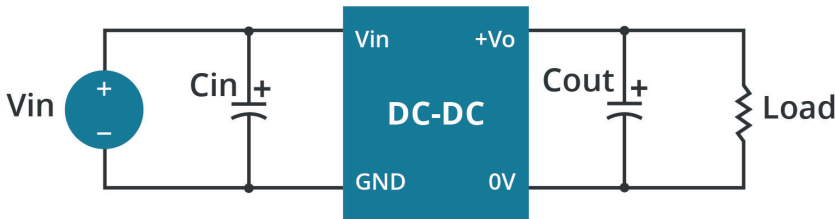

**Figure 2**  
Dual Output Models

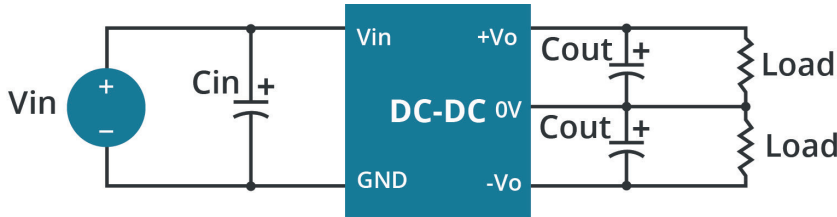
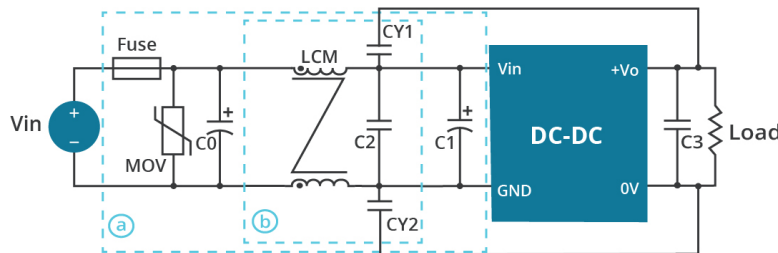

**Table 1**

Vout (Vdc)	Cin (μF)	Cout (μF)
3.3/5/9	100	220
12/15/24	100	100
±5/±12/±15	100	220
±24	100	100

## EMC RECOMMENDED CIRCUIT

**Figure 3**  
Single Output Models



**Figure 4**  
Dual Output Models

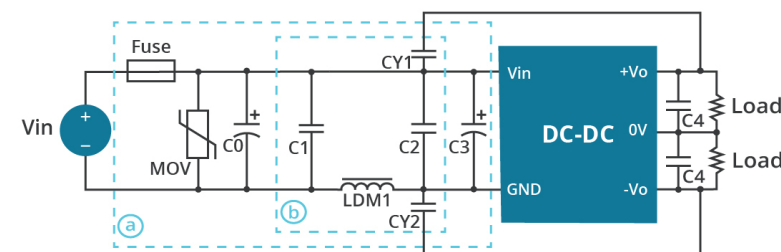

**Table 2**

Recommended External Circuit Components		
Vin (Vdc)	24	48
FUSE	choose according to actual input current	
MOV	S20K30	S14K60
C0	680 μF / 50 V	330 μF / 100 V
C1	330 μF / 50 V	330 μF / 100 V
C2	4.7 μF / 50 V	2.2 μF / 100 V
C3	Refer to the Cout in Table 1	
LCM	1 mH	
CY1, CY2	1 nF / 2 kV	

**Table 3**

Recommended External Circuit Components		
Vin (Vdc)	24	48
FUSE	choose according to actual input current	
MOV	S20K30	S14K60
C0	680 μF / 50 V	330 μF / 100 V
C1	2.2 μF / 50 V	2.2 μF / 100 V
C2	2.2 μF / 50 V	2.2 μF / 100 V
C3	330 μF / 50 V	330 μF / 100 V
C4	Refer to the Cout in Table 1	
LDM1	3.3 μH	
CY1, CY2	2.2 nF / 4 kV	

## APPLICATION NOTES

Output voltage trimming  
Leave open if not used.

Trim up

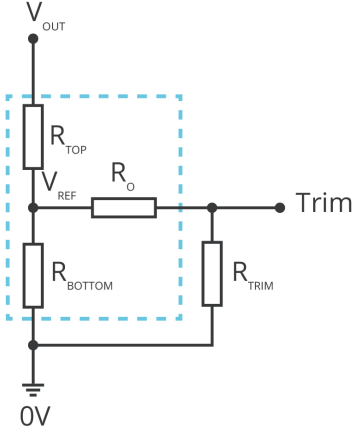

Trim down

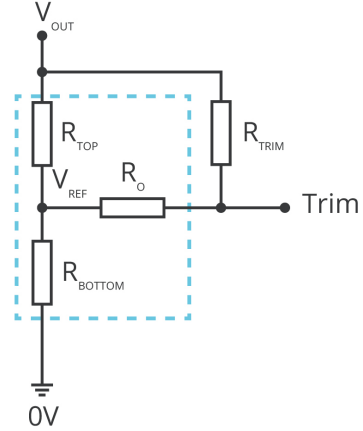

$$R_{TRIM} = \frac{a \cdot R_{BOTTOM}}{R_{BOTTOM} - a} - R_O \quad a = \frac{V_{REF}}{V_{OUT} - V_{REF}} \cdot R_{TOP}$$

Formula for Trim up

$$R_{TRIM} = \frac{a \cdot R_{TOP}}{R_{TOP} - a} - R_O \quad a = \frac{V_{OUT} - V_{REF}}{V_{REF}} \cdot R_{BOTTOM}$$

Formula for Trim down

Table 3

$V_{OUT}$ (Vdc)	$R_{TOP}$ (kΩ)	$R_{BOTTOM}$ (kΩ)	$R_O$ (kΩ)	$V_{REF}$ (V)
3.3	4.801	2.87	12.4	1.24
5	2.887	2.87	10	2.5
9	7.500	2.87	15	2.5
12	11.000	2.87	15	2.5
15	14.494	2.87	15	2.5
24	24.872	2.87	17.8	2.5

Note: Value for  $R_{TOP}$ ,  $R_{BOTTOM}$ ,  $R_O$ , and  $V_{REF}$  refer to Table 3 (fixed internal values).  
 $R_{TRIM}$ : Trim resistance  
 a: User-defined parameter, no actual meanings  
 $V_{OUT}$ : Nominal output voltage

## REVISION HISTORY

rev.	description	date
1.0	initial release	01/24/2019
1.01	safeties updated in features and safety line, packaging removed	01/12/2021
1.02	derating curves and circuit figures updated	08/23/2021
1.03	temperature updated & application section updated	08/08/2022
1.04	input current updated	09/21/2022
1.05	U-frame model added	09/26/2022
1.06	UKCA added for 48 Vdc input models	11/15/2022
1.07	heatsink option added	03/08/2023
1.08	board mount with heatsink mechanical drawing updated	03/23/2023
1.09	heatsink option availability updated	05/17/2023
1.10	product image updated	06/16/2023
1.11	heatsink option availability updated	09/08/2023
1.12	solderability section updated	09/22/2023
1.13	CE certification updated for specific models	11/10/2023

The revision history provided is for informational purposes only and is believed to be accurate.



# CUI INC

a bel group

**Headquarters**  
20050 SW 112th Ave.  
Tualatin, OR 97062  
**800.275.4899**

Fax 503.612.2383  
**cui.com**  
techsupport@cui.com

CUI offers a two (2) year limited warranty. Complete warranty information is listed on our website.

CUI reserves the right to make changes to the product at any time without notice. Information provided by CUI is believed to be accurate and reliable. However, no responsibility is assumed by CUI for its use, nor for any infringements of patents or other rights of third parties which may result from its use.

CUI products are not authorized or warranted for use as critical components in equipment that requires an extremely high level of reliability. A critical component is any component of a life support device or system whose failure to perform can be reasonably expected to cause the failure of the life support device or system, or to affect its safety or effectiveness.