

**PKE3000 series DC-DC Converters**  
 Input 9 - 36 V, Output up to 7 A / 30 W

28701- BMR7103000 Rev. L March 2022  
 © Flex

### Key Features

- Industry standard case dimensions  
 25.4 \* 25.4 \* 11.4 mm (1.0 \* 1.0 \* 0.45 in)
- High efficiency, typ. 92% at 24 Vin, 12 Vout / 30W
- 1500 Vdc input to output isolation
- Compliant with IEC/UL 62368 standard

### General Characteristics

- Input under voltage shutdown
- Output over voltage protection
- Output short-circuit protection
- Output voltage adjust function
- Over temperature protection
- Monotonic start-up
- Remote control
- ISO 9001/14001 certified supplier



### Safety Approvals



### Design for Environment



Meets requirements in high-temperature lead-free soldering processes.

### Contents

Ordering Information	2
General Information	2
Safety Specification	3
Absolute Maximum Ratings	4
Electrical Specification	
3.3 V, 4.5 A / 15 W	PKE3210PI(P) ..... 5
5 V, 3 A / 15 W	PKE3211PI(P) ..... 8
12 V, 1.25 A / 15 W	PKE3213PI(P) ..... 11
15 V, 1 A / 15 W	PKE3215PI(P) ..... 14
3.3 V, 7 A / 23.1 W	PKE3310PI(P) ..... 17
5 V, 6 A / 30 W	PKE3311PI(P) ..... 20
12 V, 2.5 A / 30 W	PKE3313PI(P) ..... 23
15 V, 2 A / 30 W	PKE3315PI(P) ..... 26
24 V, 1.25 A / 30 W	PKE3316ZPI(P) ..... 29
48 V, 0.625 A / 30 W	PKE3316JPI(P) ..... 32
54 V, 0.463 A / 25 W	PKE3316HPI(P) ..... 35
EMC Specification	38
Operating Information	40
Thermal Consideration	41
Connections	43
Mechanical Information	44
Soldering Information	45
Delivery Information	45
Product Qualification Specification	46

## Technical Specification

**PKE3000 series DC-DC Converters**  
Input 9 - 36 V, Output up to 7 A / 30 W

28701- BMR7103000 Rev. L March 2022

© Flex

## Ordering Information

Product program	Output
PKE3210PI	3.3 V, 4.5 A / 15 W
PKE3211PI	5.0 V, 3 A / 15 W
PKE3213PI	12 V, 1.25 A / 15 W
PKE3215PI	15 V, 1 A / 15 W
PKE3310PI	3.3 V, 7 A / 23.1 W
PKE3311PI	5 V, 6 A / 30 W
PKE3313PI	12 V, 2.5 A / 30 W
PKE3315PI	15 V, 2 A / 30 W
PKE3316ZPI	24 V, 1.25 A / 30 W
PKE3316JPI	48 V, 0.625 A / 30 W
PKE3316HPI	54 V, 0.463 A / 25 W

## Product number and Packaging

PKE3XXXXn <sub>1</sub> n <sub>2</sub>		
Options	n <sub>1</sub>	n <sub>2</sub>
Mounting	o	
Remote Control logic		o

## Options Description

Options	Description
n <sub>1</sub>	PI Through hole
n <sub>2</sub>	Negative * Positive

Example positive logic product with tray packing would be PKE3213PIP.

\* Standard variant (i.e. no option selected)

## General Information

## Reliability

The failure rate ( $\lambda$ ) and mean time between failures (MTBF =  $1/\lambda$ ) is calculated at max output power and an operating ambient temperature ( $T_A$ ) of +25°C. Flex uses Telcordia SR-332 Issue 3 Method 1 to calculate the mean steady-state failure rate and standard deviation ( $\sigma$ ).

Telcordia SR-332 Issue 3 also provides techniques to estimate the upper confidence levels of failure rates based on the mean and standard deviation.

Mean steady-state failure rate, $\lambda$	Std.deviation, $\sigma$
195.215 nFailures/h (PKE32XX)	114.01 nFailures/h
219.644 nFailures/h (PKE33XXX)	88.962 nFailures/h

MTBF (mean value) for the PKE32XX = 5.12 Mh  
MTBF at 90% confidence level = 2.87 Mh

MTBF (mean value) for the PKE33XXX = 4.55 Mh.  
MTBF at 90% confidence level = 2.94 Mh

## Compatibility with RoHS requirements

The products are compatible with the relevant clauses and requirements of the RoHS directive 2011/65/EU and have a maximum concentration value of 0.1% by weight in homogeneous materials for lead, mercury, hexavalent chromium, PBB and PBDE and of 0.01% by weight in homogeneous materials for cadmium.

Exemptions in the RoHS directive utilized in Flex products are found in the Statement of Compliance document.

Flex fulfills and will continuously fulfill all its obligations under regulation (EC) No 1907/2006 concerning the registration, evaluation, authorization and restriction of chemicals (REACH) as they enter into force and is through product materials declarations preparing for the obligations to communicate information on substances in the products.

## Quality Statement

The products are designed and manufactured in an industrial environment where quality systems and methods like ISO 9000, Six Sigma, and SPC are intensively in use to boost the continuous improvements strategy. Infant mortality or early failures in the products are screened out and they are subjected to an ATE-based final test. Conservative design rules, design reviews and product qualifications, plus the high competence of an engaged work force, contribute to the high quality of the products.

## Warranty

Warranty period and conditions are defined in Flex General Terms and Conditions of Sale.

## Limitation of Liability

Flex does not make any other warranties, expressed or implied including any warranty of merchantability or fitness for a particular purpose (including, but not limited to, use in life support applications, where malfunctions of product can cause injury to a person's health or life).

## © Flex 2023

The information and specifications in this technical specification is believed to be correct at the time of publication. However, no liability is accepted for inaccuracies, printing errors or for any consequences thereof. Flex reserves the right to change the contents of this technical specification at any time without prior notice.

## Technical Specification

**PKE3000 series DC-DC Converters**  
Input 9 - 36 V, Output up to 7 A / 30 W

28701- BMR7103000 Rev. L March 2022

© Flex

## Safety Specification

### General information

PKE products are designed in accordance with the safety standards IEC 62368-1 and UL 62368-1, *Audio/video, information and communication technology equipment - Part 1: Safety requirements*

IEC/UL 62368-1 contains requirements to prevent injury or damage due to the following hazards:

- Electrical shock
- Electrically-caused fire
- Injury caused by hazardous substances
- Mechanically-caused injury
- Skin burn
- Radiation-caused injury

On-board DC/DC converters are defined as component power supplies. As components they cannot fully comply with the provisions of any safety requirements without "conditions of acceptability". Clearance between conductors and between conductive parts of the component power supply and conductors on the board in the final product must meet the applicable safety requirements. Certain conditions of acceptability apply for component power supplies with limited stand-off (see Mechanical Information for further information). It is the responsibility of the installer to ensure that the final product housing these components complies with the requirements of all applicable safety standards and regulations for the final product.

Component power supplies for general use shall comply with the requirements in IEC/UL 62368-1 or IEC/UL 62368-1. Product related standards, e.g. IEEE 802.3af *Power over Ethernet*, and ETS-300132-2 *Power interface at the input to telecom equipment, operated by direct current (dc)* are based on IEC/UL 62368-1 with regards to safety.

Flex DC/DC converters are UL 62368-1 or UL 62368-1 recognized. The flammability rating for all construction parts of the products meet requirements for V-0 class material according to IEC 60695-11-10, *Fire hazard testing, test flames* – 50 W horizontal and vertical flame test methods.

### Isolated DC/DC converters

The product provides functional insulation between input and output according to IEC/UL 62368-1.

For functional insulated products (see Safety Certificate) the output is considered as ES1 energy source if one of the following conditions is met:

- The input source provides double or reinforced insulation from the AC mains according to IEC/UL 62368-1.

- The input source provides basic or supplementary insulation from the AC mains and the product's output is reliably connected to protective earth according to IEC/UL 62368-1.
- The input source is reliably connected to protective earth and provides basic or supplementary insulation according to IEC/UL 62368-1 and the maximum input source voltage is 60 Vdc.

It is recommended to use a slow blow fuse at the input of each DC/DC converter. If an input filter is used in the circuit the fuse should be placed in front of the input filter. In the rare event of a component problem that imposes a short circuit on the input source, this fuse will provide the following functions:

- Isolate the fault from the input power source so as not to affect the operation of other parts of the system
- Protect the distribution wiring from excessive current and power loss thus preventing hazardous overheating

Technical Specification

**PKE3000 series DC-DC Converters**  
 Input 9 - 36 V, Output up to 7 A / 30 W

28701- BMR7103000 Rev. L March 2022  
 © Flex

**Absolute Maximum Ratings**

Characteristics		min	typ	max	Unit	
T <sub>P1</sub>	Operating Temperature (see Thermal Consideration section)	PKE32XX variants	-40		+110	°C
		PKE33XXX variants	-40		+115	°C
T <sub>S</sub>	Storage temperature	-55		+125	°C	
V <sub>I</sub>	Input voltage	9		36	V	
V <sub>iso</sub>	Isolation voltage (input to output test voltage)			1500	Vdc	
V <sub>tr</sub>	Input voltage transient (tp 100ms)			50	V	
V <sub>RC</sub>	Remote Control pin voltage (see Operating Information section)	Positive logic option	0		6	V
		Negative logic option	0		6	V
V <sub>adj</sub>	Adjust pin voltage (see Operating Information section)	0		V <sub>o</sub>	V	

Stresses above those listed under Absolute Maximum Ratings may cause permanent damage to the device. This is a stress rating only, functional operation of the device at these or any other conditions above those indicated in the Electrical Specification section of this specification is not implied. Exposure to absolute maximum rating conditions for extended periods may affect device reliability.

**Fundamental Circuit Diagram**

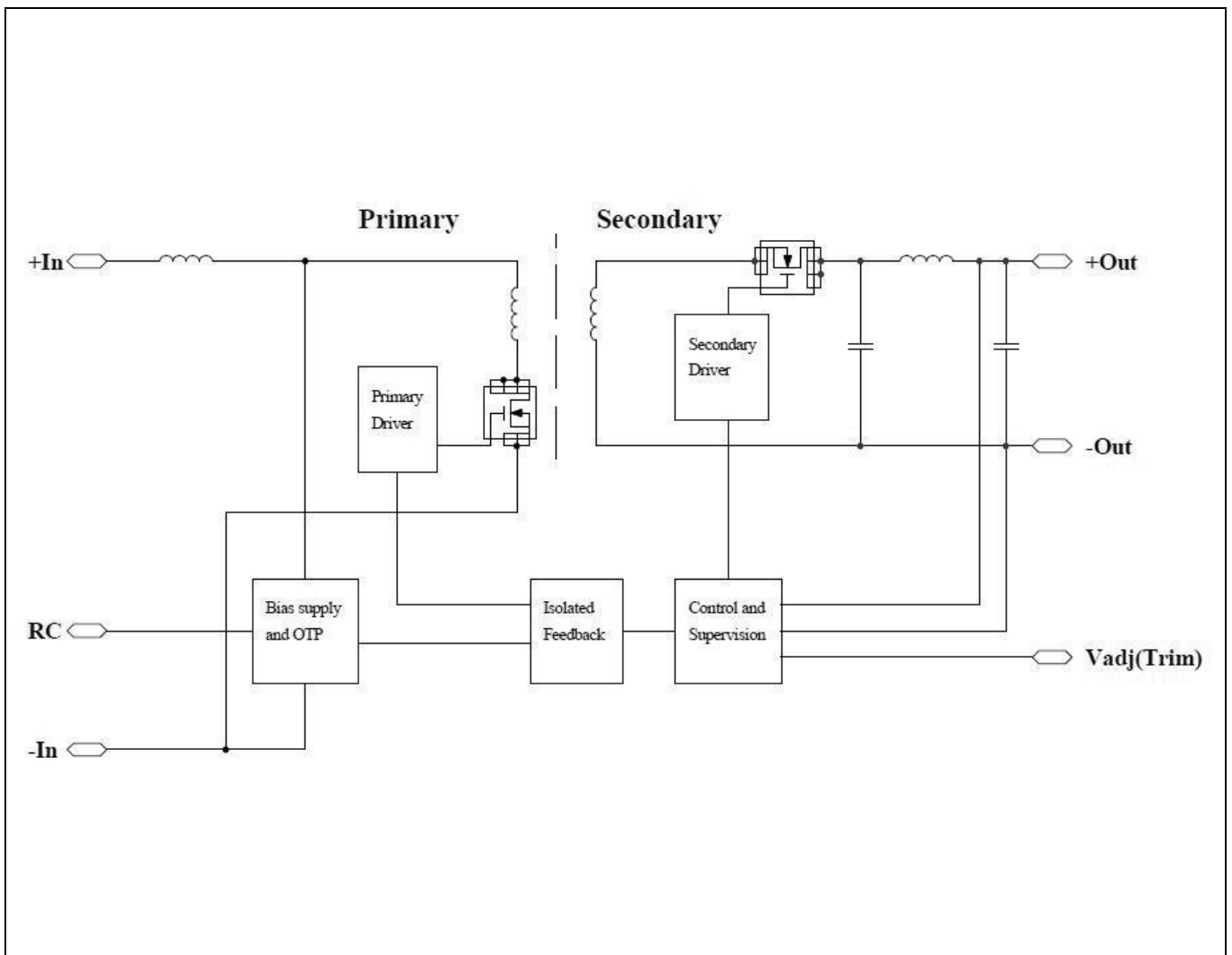

## Technical Specification

**PKE3000 series DC-DC Converters**  
Input 9 - 36 V, Output up to 7 A / 30 W

28701- BMR7103000 Rev. L

March 2022

© Flex

**Electrical Specification**  
**3.3 V, 4.5 A / 15 W**

PKE3210PI(P)

$T_{P1} = -40$  to  $+90^{\circ}\text{C}$ ,  $V_I = 9$  to  $36$  V, unless otherwise specified under Conditions.

Typical values given at:  $T_{P1} = +25^{\circ}\text{C}$ ,  $V_I = 24$  V, max  $I_O$ , unless otherwise specified under Conditions.

Additional  $C_{out} = 22$   $\mu\text{F}$  ceramic capacitor. See Operating Information section for selection of capacitor types.

Characteristics		Conditions	min	typ	max	Unit
$V_I$	Input voltage range		9		36	V
$V_{loff}$	Turn-off input voltage	Decreasing input voltage	6.5	7.0	8.0	V
$V_{lon}$	Turn-on input voltage	Increasing input voltage	7.5	8.1	8.8	V
$C_I$	Internal input capacitance			10		$\mu\text{F}$
$P_O$	Output power		0		15	W
$\eta$	Efficiency	50% of max $I_O$ , $V_I = 24\text{V}$		84.6		%
		max $I_O$ , $V_I = 24\text{V}$		87.4		
		50% of max $I_O$ , $V_I = 12\text{V}$		88.2		
		max $I_O$ , $V_I = 12\text{V}$		86.2		
$P_d$	Power Dissipation	max $I_O$		2.2	5.0	W
$P_{li}$	Input idling power	$I_O = 0$ A, $V_I = 24$ V		0.866		W
$P_{RC}$	Input standby power	$V_I = 24$ V (turned off with RC)		0.240		W
$f_s$	Switching frequency	0-100 % of max $I_O$	340	400	460	kHz

$V_{Oi}$	Output voltage initial setting and accuracy	$T_{P1} = +25^{\circ}\text{C}$ , $V_I = 24$ V, $I_O = 4.5$ A	3.26	3.30	3.34	V
$V_O$	Output adjust range	See operating information	2.97		3.63	V
	Output voltage tolerance band	10-100% of max $I_O$	3.17		3.43	V
	Idling voltage	$I_O = 0$ A	3.0		3.6	V
	Line regulation	max $I_O$		2	10	mV
	Load regulation	$V_I = 24$ V, 10-100% of max $I_O$		10	33	mV
$V_{tr}$	Load transient voltage deviation	$V_I = 24$ V, Load step 25-75-25% of max $I_O$ , $di/dt = 1$ A/ $\mu\text{s}$		$\pm 273$	$\pm 700$	mV
$t_{tr}$	Load transient recovery time			210	500	$\mu\text{s}$
$t_r$	Ramp-up time (from 10-90% of $V_{Oi}$ )	10-100% of max $I_O$	0.1	0.86	5	ms
$t_s$	Start-up time (from $V_I$ connection to 90% of $V_{Oi}$ )		1	6	30	ms
$t_f$	$V_I$ shut-down fall time (from $V_I$ off to 10% of $V_O$ )	max $I_O$		0.34		ms
		$I_O = 0$ A		1.6		s
$t_{RC}$	RC start-up time	max $I_O$		5.6		ms
	RC shut-down fall time (from RC off to 10% of $V_O$ )	max $I_O$		0.1		ms
		$I_O = 0$ A		1.7		s
$I_O$	Output current		0.45		4.5	A
$I_{lim}$	Current limit threshold	$V_I = 24$ V, $T_{P1} < \text{max } T_{P1}$	4.8	8.0	11.2	A
$I_{sc}$	Short circuit current	$T_{P1} = 25^{\circ}\text{C}$ , see Note 1		2.6		A
$C_{out}$	Recommended Capacitive Load	$T_{P1} = 25^{\circ}\text{C}$ , $V_I = 24$ V, see Note 2	0		5000	$\mu\text{F}$
$V_{Oac}$	Output ripple & noise	See ripple & noise section, $V_{Oi}$		17	34	mVp-p
OVP	Over voltage protection	$T_{P1} = +25^{\circ}\text{C}$ , $V_I = 24$ V, 0-100% of max $I_O$		3.9		V
RC	Sink current, see Note 3	See operating information	10			mA
	Trigger level	See operating information	2.5			V

Note 1: Output current (RMS), hiccup mode

Note 2: Test condition: Electrolytic Capacitor with 10% - full load

Note 3: Sink current drawn by external device connected to the RC pin. Minimum sink current required to guarantee activated RC function.

**PKE3000 series DC-DC Converters**  
 Input 9 - 36 V, Output up to 7 A / 30 W

28701- BMR7103000 Rev. L

March 2022

© Flex

**Typical Characteristics**  
**3.3 V, 4.5 A / 15 W**

**PKE3210PI(P)**

**Efficiency**

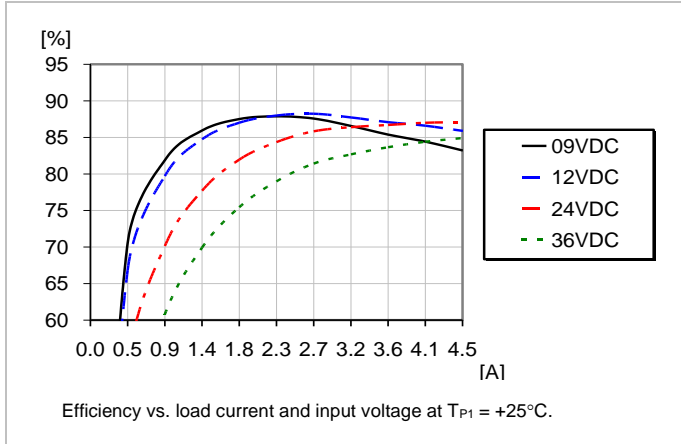

**Power Dissipation**

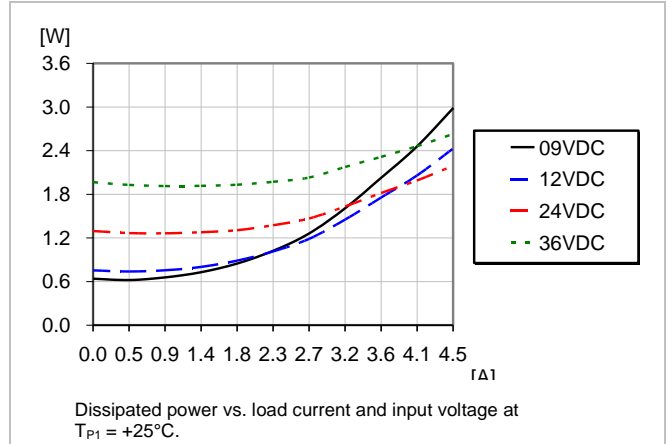

**Output Characteristics**

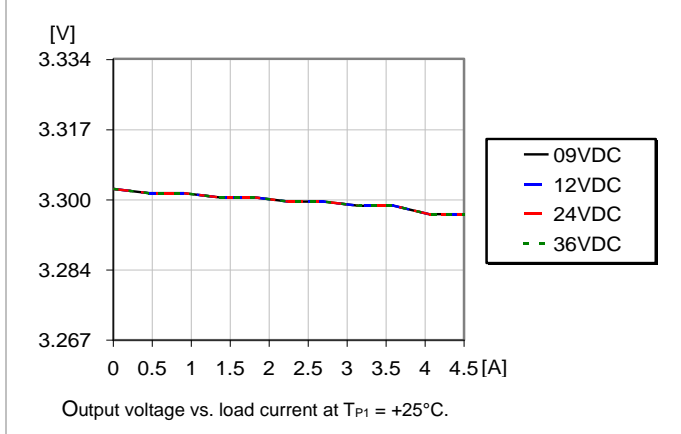

**Current Limit Characteristics**

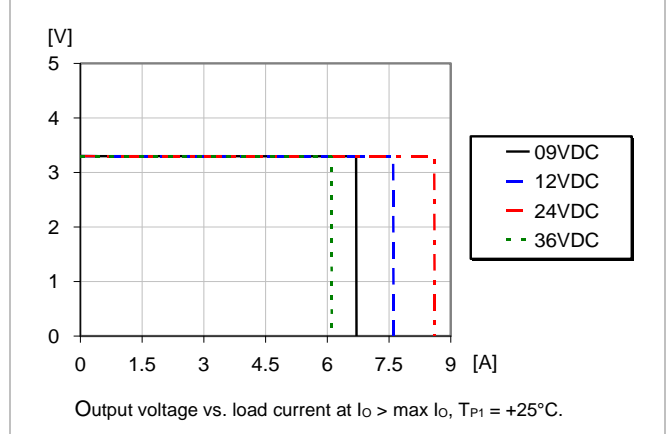

**Output Current Derating**

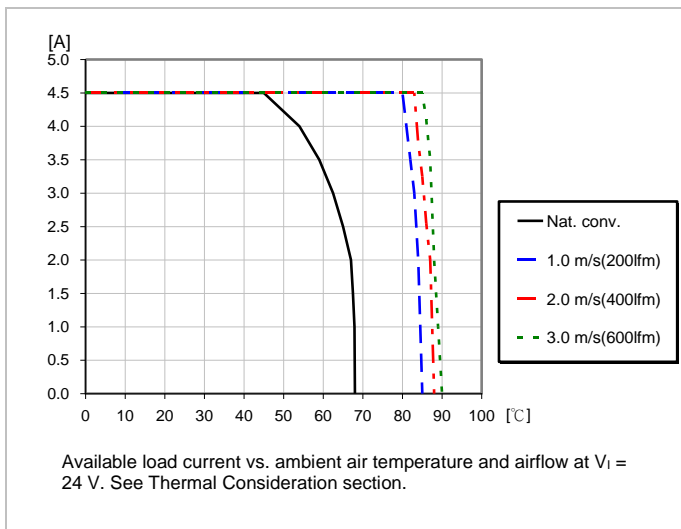

**Thermal Resistance**

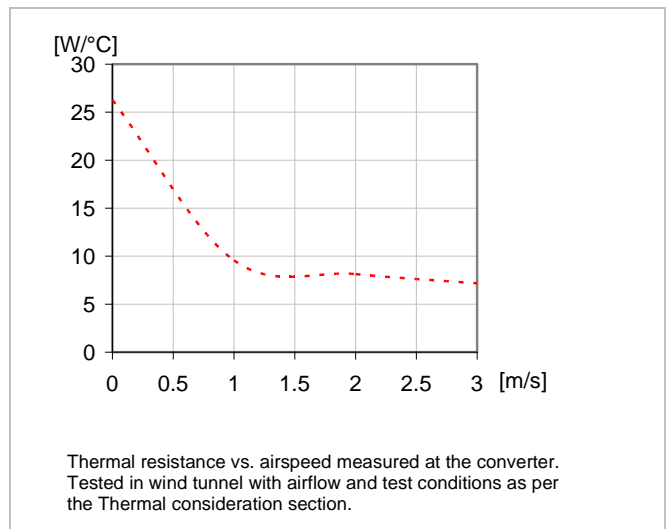

**PKE3000 series DC-DC Converters**  
 Input 9 - 36 V, Output up to 7 A / 30 W

28701- BMR7103000 Rev. L March 2022  
 © Flex

**Typical Characteristics**  
 3.3 V, 4.5 A / 15 W

**PKE3210PI(P)**

**Start-up**

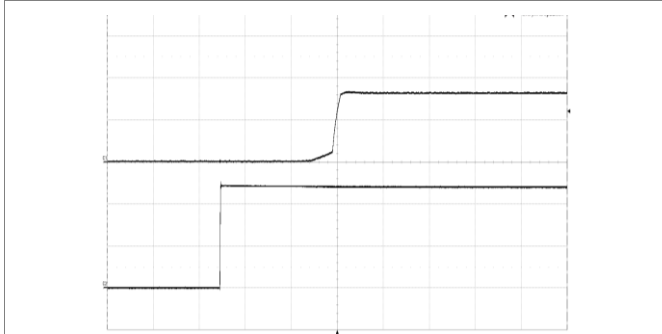

Start-up enabled by connecting  $V_I$  at:  
 $T_{P1} = +25^{\circ}\text{C}$ ,  $V_I = 24\text{ V}$ ,  
 $I_O = 4.5\text{ A}$  electronic load.  
 Top trace: output voltage (2 V/div.).  
 Bottom trace: input voltage (10 V/div.).  
 Time scale: (2 ms/div.).

**Shut-down**

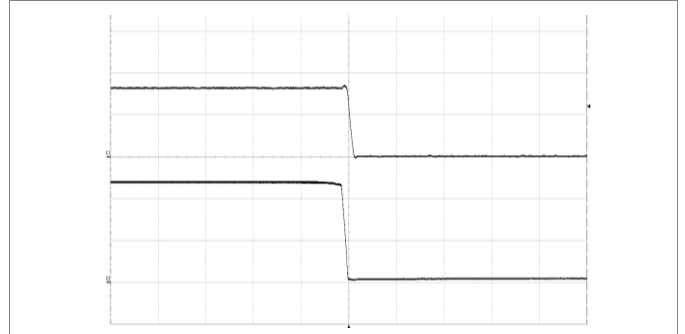

Output disabled by removing  $V_I$  at:  
 $T_{P1} = +25^{\circ}\text{C}$ ,  $V_I = 24\text{ V}$ ,  
 $I_O = 4.5\text{ A}$  electronic load.  
 Top trace: output voltage (2 V/div.).  
 Bottom trace: input voltage (10 V/div.).  
 Time scale: (1 ms/div.).

**Output Ripple & Noise**

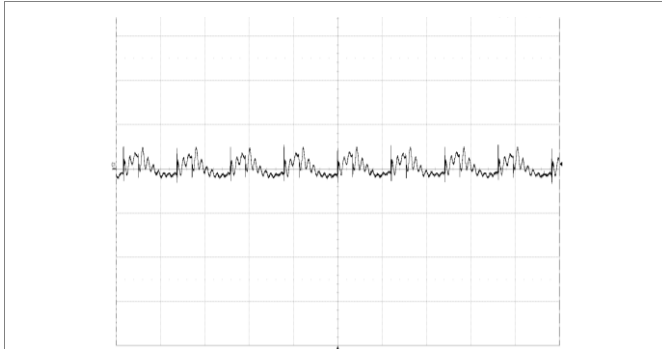

Output voltage ripple at:  
 $T_{P1} = +25^{\circ}\text{C}$ ,  $V_I = 24\text{ V}$ ,  
 $I_O = 4.5\text{ A}$  electronic load  
 Trace: output voltage (20 mV/div.).  
 Time scale: (2 μs/div.)  
 20 MHz bandwidth

**Output Load Transient Response**



Output voltage response to load current step-  
 change (1.125-3.375-1.125 A) at:  
 $T_{P1} = +25^{\circ}\text{C}$ ,  $V_I = 24\text{ V}$ ,  $di/dt = 1\text{ A}/\mu\text{s}$   
 $C_O = 22\text{ }\mu\text{F}$  ceramic capacitor  
 Top trace: output voltage (200 mV/div.).  
 Bottom trace: load current (2 A/div.).  
 Time scale: (0.5 ms/div.).

**Output Voltage Adjust (see operating information)**

**Passive adjust**

The resistor value for an adjusted output voltage is calculated by using the following equations:

To adjust the output voltage upwards, a resistor is connected between pins 5 and 6. The output voltage increases when the resistance decreases. The resistance value is given by the equation:  
 $R_{ou} = 5.6 \times (1.1406V_{oi} - V_{od}) / (V_{od} - V_{oi})$ , (KOhm);  $V_{od}$  is the desired output voltage and  $V_{oi}$  is the initial output voltage.

To adjust the output voltage downwards, a resistor is connected between pins 4 and 5. The output voltage decreases when the resistance decreases. The resistance value is given by the equation:

$R_{od} = 6.3875 \times (1.1585V_{od} - V_{oi}) / (V_{oi} - V_{od})$ , (KOhm);  $V_{od}$  is the desired output voltage and  $V_{oi}$  is the initial output voltage.

## Technical Specification

**PKE3000 series DC-DC Converters**  
Input 9 - 36 V, Output up to 7 A / 30 W

28701- BMR7103000 Rev. L

March 2022

© Flex

**Electrical Specification**  
**5 V, 3 A / 15 W**

PKE3211PI(P)

$T_{P1} = -40$  to  $+90^{\circ}\text{C}$ ,  $V_I = 9$  to  $36$  V, unless otherwise specified under Conditions.

Typical values given at:  $T_{P1} = +25^{\circ}\text{C}$ ,  $V_I = 24$  V, max  $I_O$ , unless otherwise specified under Conditions.

Additional  $C_{out} = 22 \mu\text{F}$  ceramic capacitor. See Operating Information section for selection of capacitor types.

Characteristics		Conditions	min	typ	max	Unit
$V_I$	Input voltage range		9		36	V
$V_{loff}$	Turn-off input voltage	Decreasing input voltage	6.5	7.0	8.0	V
$V_{lon}$	Turn-on input voltage	Increasing input voltage	7.5	8.1	8.8	V
$C_I$	Internal input capacitance			10		$\mu\text{F}$
$P_O$	Output power		0		15	W
$\eta$	Efficiency	50% of max $I_O$ , $V_I = 24\text{V}$		88.0		%
		max $I_O$ , $V_I = 24\text{V}$		89.1		
		50% of max $I_O$ , $V_I = 12\text{V}$		89.9		
		max $I_O$ , $V_I = 12\text{V}$		87.4		
$P_d$	Power Dissipation	max $I_O$		1.9	5.0	W
$P_{li}$	Input idling power	$I_O = 0$ A, $V_I = 24$ V		0.782		W
$P_{RC}$	Input standby power	$V_I = 24$ V (turned off with RC)		0.240		W
$f_s$	Switching frequency	0-100 % of max $I_O$	340	400	460	kHz

$V_{Oi}$	Output voltage initial setting and accuracy	$T_{P1} = +25^{\circ}\text{C}$ , $V_I = 24$ V, $I_O = 3$ A	4.94	5.00	5.06	V
$V_O$	Output adjust range	See operating information	4.50		5.50	V
	Output voltage tolerance band	10-100% of max $I_O$	4.8		5.2	V
	Idling voltage	$I_O = 0$ A	4.6		5.4	V
	Line regulation	max $I_O$		2	10	mV
	Load regulation	$V_I = 24$ V, 10-100% of max $I_O$		10	50	mV
$V_{tr}$	Load transient voltage deviation	$V_I = 24$ V, Load step 25-75-25% of max $I_O$ , $di/dt = 1$ A/ $\mu\text{s}$		$\pm 175$	$\pm 500$	mV
$t_{tr}$	Load transient recovery time			150	500	$\mu\text{s}$
$t_r$	Ramp-up time (from 10-90% of $V_{Oi}$ )	10-100% of max $I_O$	0.1	0.8	5	ms
$t_s$	Start-up time (from $V_I$ connection to 90% of $V_{Oi}$ )		1	5.8	30	ms
$t_f$	$V_I$ shut-down fall time (from $V_I$ off to 10% of $V_O$ )	max $I_O$		0.37		ms
		$I_O = 0$ A		0.95		s
$t_{RC}$	RC start-up time	max $I_O$		6.2		ms
	RC shut-down fall time (from RC off to 10% of $V_O$ )	max $I_O$		0.22		ms
		$I_O = 0$ A		1		s
$I_O$	Output current		0.3		3	A
$I_{lim}$	Current limit threshold	$V_I = 24$ V, $T_{P1} < \text{max } T_{P1}$	3.2	5.0	6.8	A
$I_{sc}$	Short circuit current	$T_{P1} = 25^{\circ}\text{C}$ , see Note 1		2.9		A
$C_{out}$	Recommended Capacitive Load	$T_{P1} = 25^{\circ}\text{C}$ , $V_I = 24$ V, see Note 2	0		3000	$\mu\text{F}$
$V_{Oac}$	Output ripple & noise	See ripple & noise section, $V_{Oi}$		17	34	mVp-p
OVP	Over voltage protection	$T_{P1} = +25^{\circ}\text{C}$ , $V_I = 24$ V, 0-100% of max $I_O$		6.2		V
RC	Sink current, see Note 3	See operating information	10			mA
	Trigger level	See operating information	2.5			V

Note 1: Output current (RMS), hiccup mode

Note 2: Test condition: Electrolytic Capacitor with 10% - full load

Note 3: Sink current drawn by external device connected to the RC pin. Minimum sink current required to guarantee activated RC function.



**PKE3000 series DC-DC Converters**  
 Input 9 - 36 V, Output up to 7 A / 30 W

28701- BMR7103000 Rev. L

March 2022

© Flex

### Typical Characteristics 5 V, 3 A / 15 W

**PKE3211PI(P)**

#### Efficiency

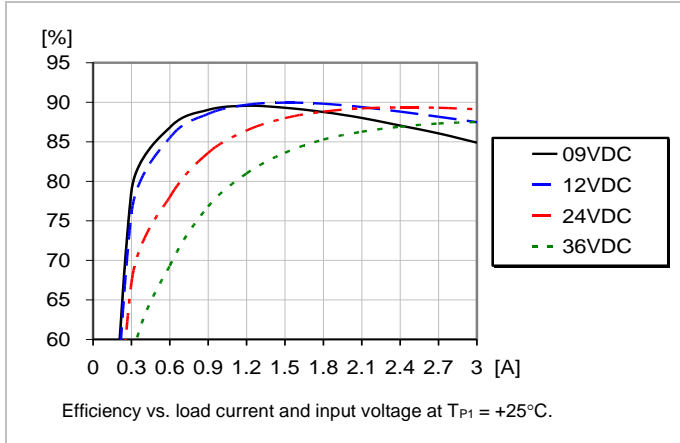

#### Power Dissipation

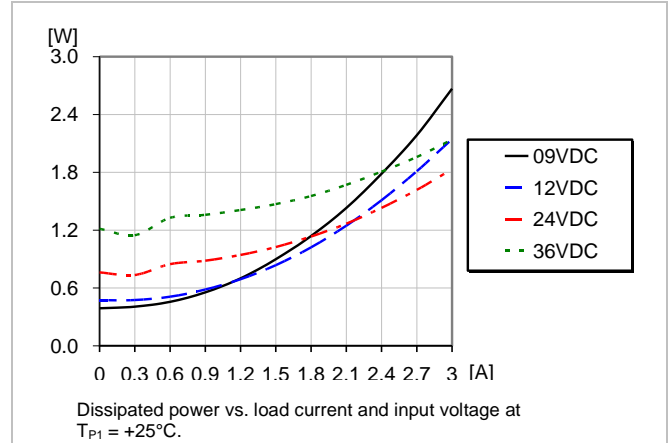

#### Output Characteristics

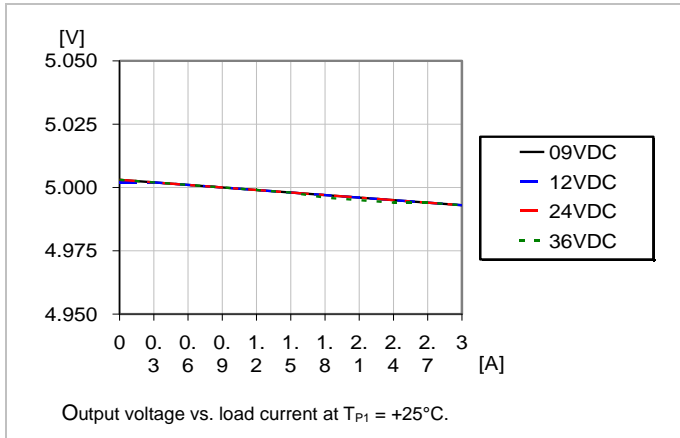

#### Current Limit Characteristics

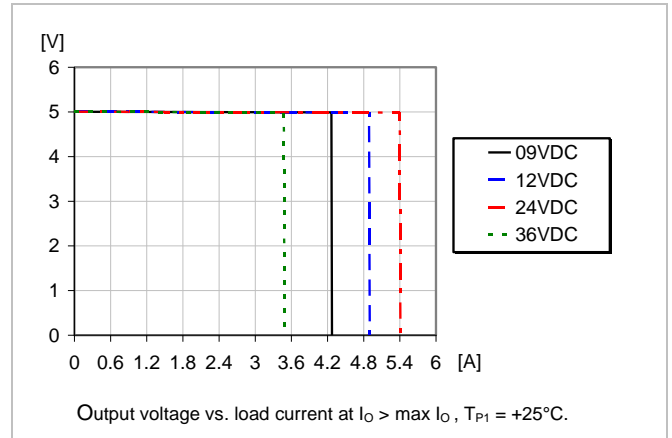

#### Output Current Derating

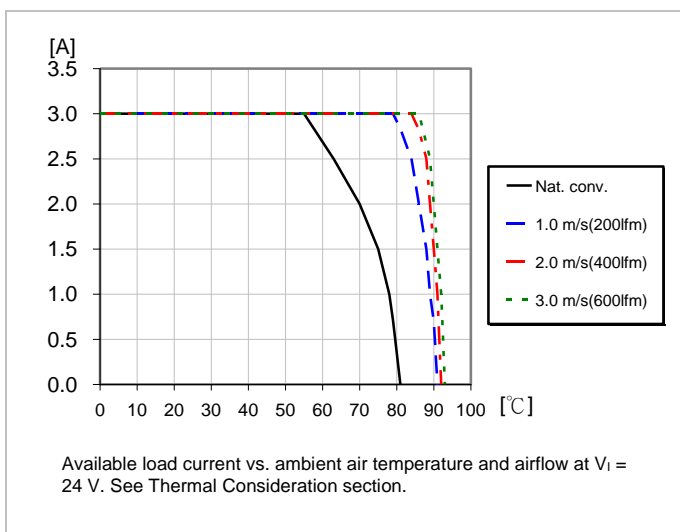

#### Thermal Resistance

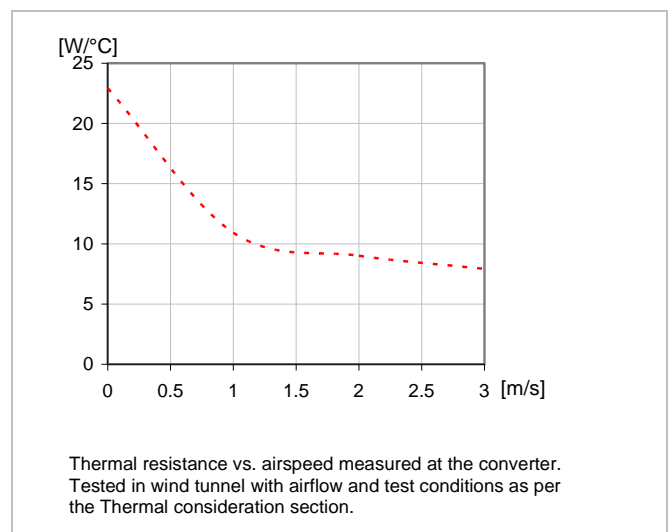

Technical Specification

**PKE3000 series DC-DC Converters**  
 Input 9 - 36 V, Output up to 7 A / 30 W

28701- BMR7103000 Rev. L March 2022  
 © Flex

**Typical Characteristics**  
 5 V, 3 A / 15 W

**PKE3211P(P)**

**Start-up**

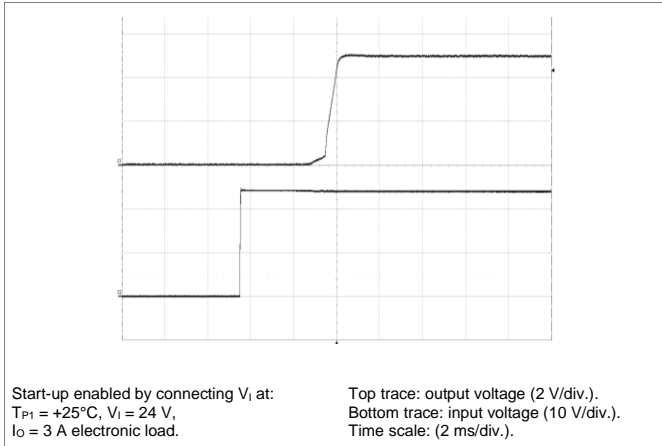

**Shut-down**

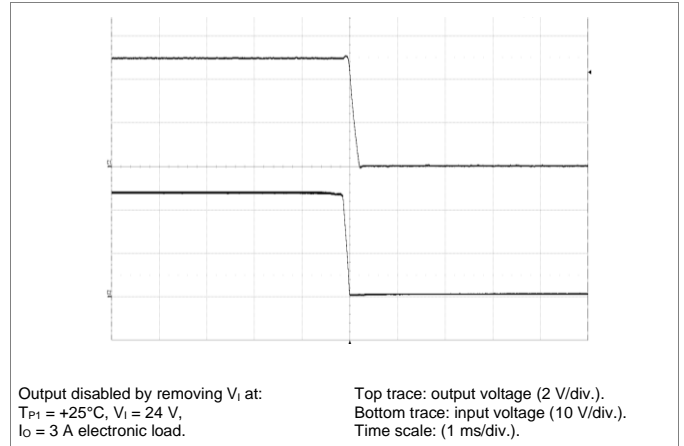

**Output Ripple & Noise**

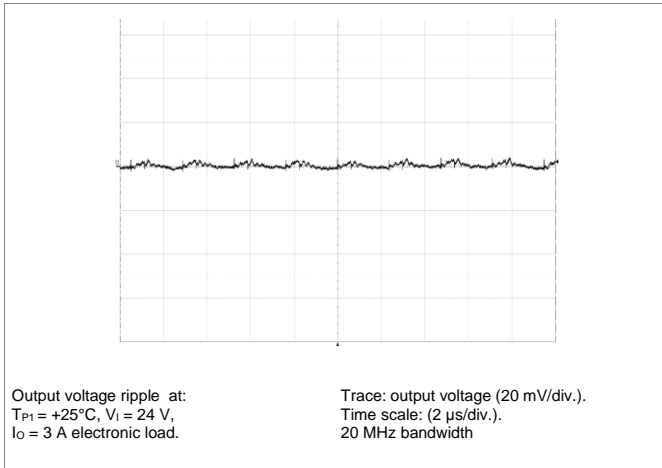

**Output Load Transient Response**

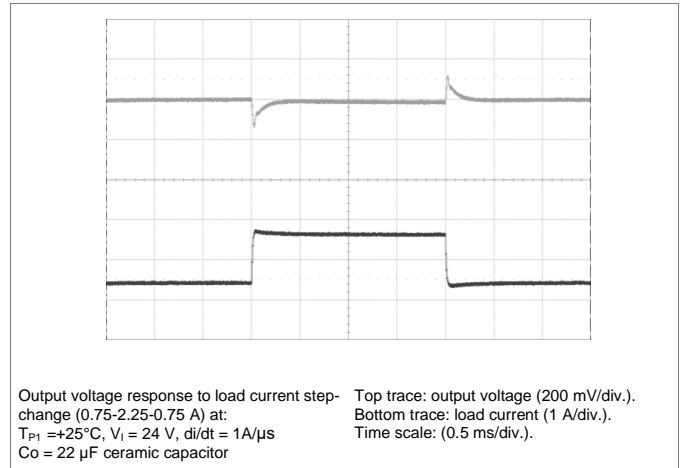

**Output Voltage Adjust (see operating information)**

**Passive adjust**

The resistor value for an adjusted output voltage is calculated by using the following equations:

To adjust the output voltage upwards, a resistor is connected between pins 5 and 6. The output voltage increases when the resistance decreases. The resistance value is given by the equation:  
 $R_{ou} = 3.3 \times (1.1515V_{oi} - V_{od}) / (V_{od} - V_{oi})$ , (KOhm);  $V_{od}$  is the desired output voltage and  $V_{oi}$  is the initial output voltage.

To adjust the output voltage downwards, a resistor is connected between pins 4 and 5. The output voltage decreases when the resistance decreases. The resistance value is given by the equation:

$R_{od} = 3.8 \times (1.1316V_{od} - V_{oi}) / (V_{oi} - V_{od})$ , (KOhm);  $V_{od}$  is the desired output voltage and  $V_{oi}$  is the initial output voltage.

## Technical Specification

**PKE3000 series DC-DC Converters**  
Input 9 - 36 V, Output up to 7 A / 30 W

28701- BMR7103000 Rev. L March 2022  
© Flex

**Electrical Specification**  
**12 V, 1.25 A / 15 W**

PKE3213PI(P)

$T_{P1} = -40$  to  $+90^{\circ}\text{C}$ ,  $V_I = 9$  to  $36$  V, unless otherwise specified under Conditions.

Typical values given at:  $T_{P1} = +25^{\circ}\text{C}$ ,  $V_I = 24$  V, max  $I_O$ , unless otherwise specified under Conditions.

Additional  $C_{out} = 22 \mu\text{F}$  ceramic capacitor. See Operating Information section for selection of capacitor types.

Characteristics		Conditions	min	typ	max	Unit
$V_I$	Input voltage range		9		36	V
$V_{loff}$	Turn-off input voltage	Decreasing input voltage	6.5	7.0	8.0	V
$V_{lon}$	Turn-on input voltage	Increasing input voltage	7.5	8.1	8.8	V
$C_I$	Internal input capacitance			10		$\mu\text{F}$
$P_O$	Output power		0		15	W
$\eta$	Efficiency	50% of max $I_O$ , $V_I = 24\text{V}$		86.5		%
		max $I_O$ , $V_I = 24\text{V}$		89.0		
		50% of max $I_O$ , $V_I = 12\text{V}$		88.2		
		max $I_O$ , $V_I = 12\text{V}$		87.4		
$P_d$	Power Dissipation	max $I_O$		1.9	5.0	W
$P_{li}$	Input idling power	$I_O = 0$ A, $V_I = 24$ V		0.760		W
$P_{RC}$	Input standby power	$V_I = 24$ V (turned off with RC)		0.240		W
$f_s$	Switching frequency	0-100 % of max $I_O$	340	400	460	kHz

$V_{Oi}$	Output voltage initial setting and accuracy	$T_{P1} = +25^{\circ}\text{C}$ , $V_I = 24$ V, $I_O = 1.25$ A	11.85	12.00	12.15	V
$V_O$	Output adjust range	See operating information	10.8		13.2	V
	Output voltage tolerance band	10-100% of max $I_O$	11.52		12.48	V
	Idling voltage	$I_O = 0$ A	11.30		12.7	V
	Line regulation	max $I_O$		2	24	mV
	Load regulation	$V_I = 24$ V, 10-100% of max $I_O$		5	120	mV
$V_{tr}$	Load transient voltage deviation	$V_I = 24$ V, Load step 25-75-25% of max $I_O$ , $di/dt = 1$ A/ $\mu\text{s}$		$\pm 250$	$\pm 700$	mV
$t_{tr}$	Load transient recovery time			200	500	$\mu\text{s}$
$t_r$	Ramp-up time (from 10-90% of $V_{Oi}$ )	10-100% of max $I_O$	0.1	1.2	5	ms
$t_s$	Start-up time (from $V_I$ connection to 90% of $V_{Oi}$ )		1	5.8	30	ms
$t_f$	$V_I$ shut-down fall time (from $V_I$ off to 10% of $V_O$ )	max $I_O$		0.57		ms
		$I_O = 0$ A		0.15		s
$t_{RC}$	RC start-up time	max $I_O$		5.1		ms
	RC shut-down fall time (from RC off to 10% of $V_O$ )	max $I_O$		0.28		ms
		$I_O = 0$ A		0.16		s
$I_O$	Output current		0.125		1.25	A
$I_{lim}$	Current limit threshold	$V_I = 24$ V, $T_{P1} < \text{max } T_{P1}$	1.35	2.25	3.15	A
$I_{sc}$	Short circuit current	$T_{P1} = 25^{\circ}\text{C}$ , see Note 1		1.4		A
$C_{out}$	Recommended Capacitive Load	$T_{P1} = 25^{\circ}\text{C}$ , $V_I = 24$ V, see Note 2	0		470	$\mu\text{F}$
$V_{Oac}$	Output ripple & noise	See ripple & noise section, $V_{Oi}$		20	40	mVp-p
OVP	Over voltage protection	$T_{P1} = +25^{\circ}\text{C}$ , $V_I = 24$ V, 0-100% of max $I_O$		15		V
RC	Sink current, see Note 3	See operating information	10			mA
	Trigger level	See operating information	2.5			V

Note 1: Output current (RMS), hiccup mode

Note 2: Test condition: Electrolytic Capacitor with 10% - full load

Note 3: Sink current drawn by external device connected to the RC pin. Minimum sink current required to guarantee activated RC function.

**PKE3000 series DC-DC Converters**  
 Input 9 - 36 V, Output up to 7 A / 30 W

28701- BMR7103000 Rev. L

March 2022

© Flex

**Typical Characteristics**  
**12 V, 1.25 A / 15 W**

**PKE3213PI(P)**

**Efficiency**

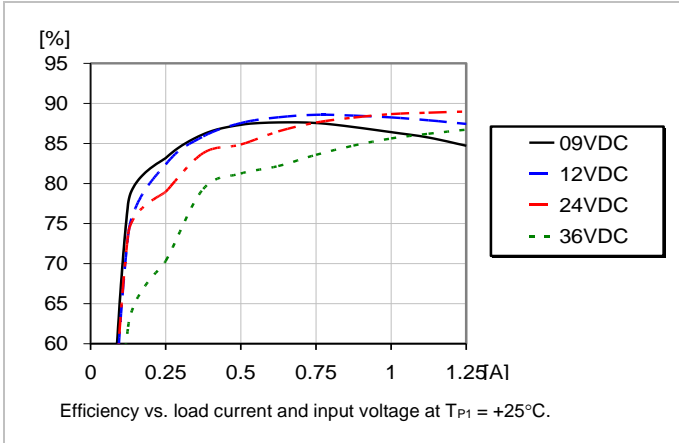

**Power Dissipation**

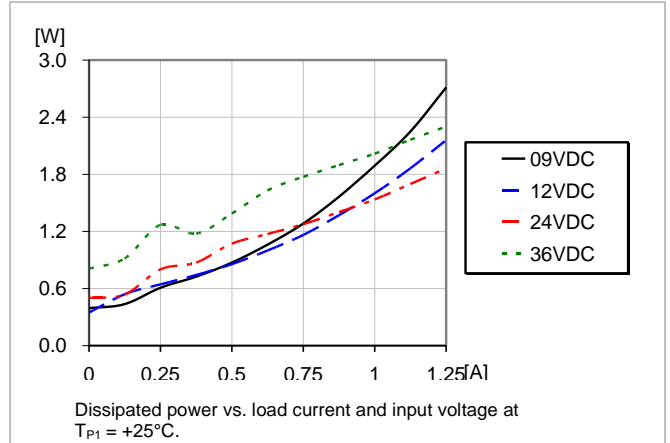

**Output Characteristics**

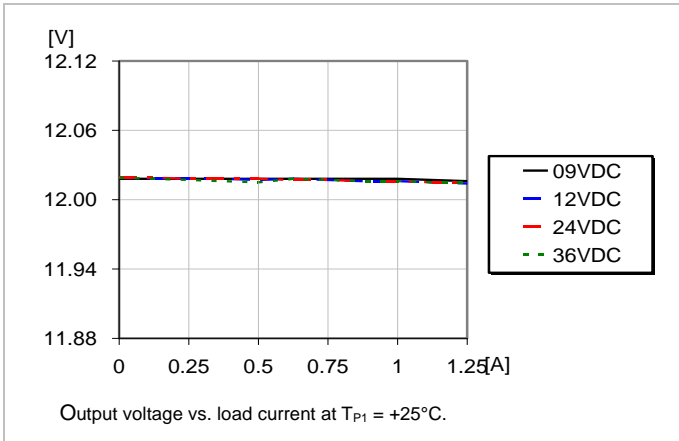

**Current Limit Characteristics**

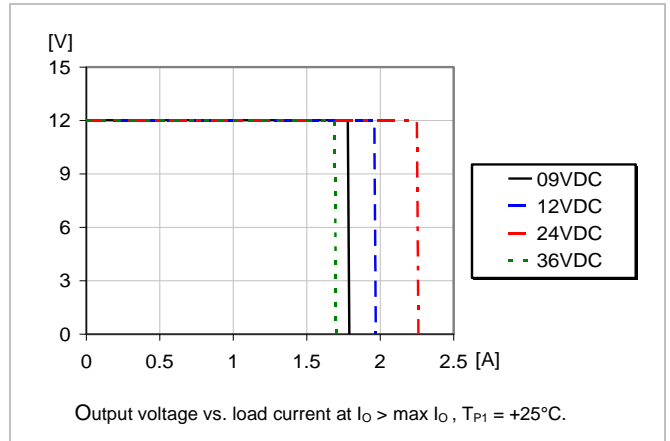

**Output Current Derating**

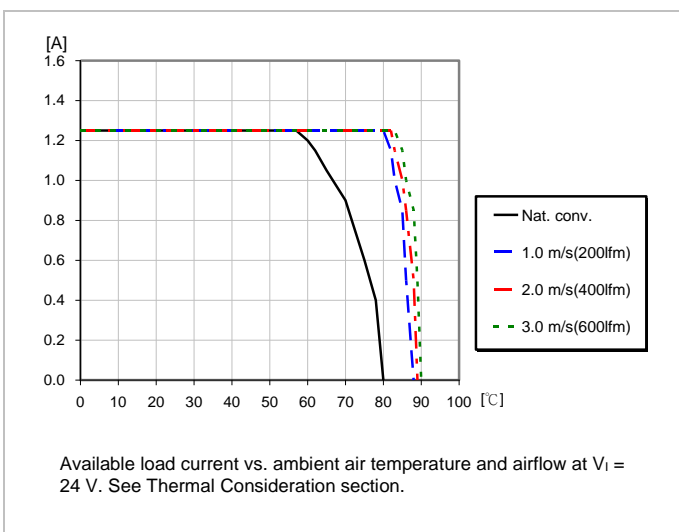

**Thermal Resistance**

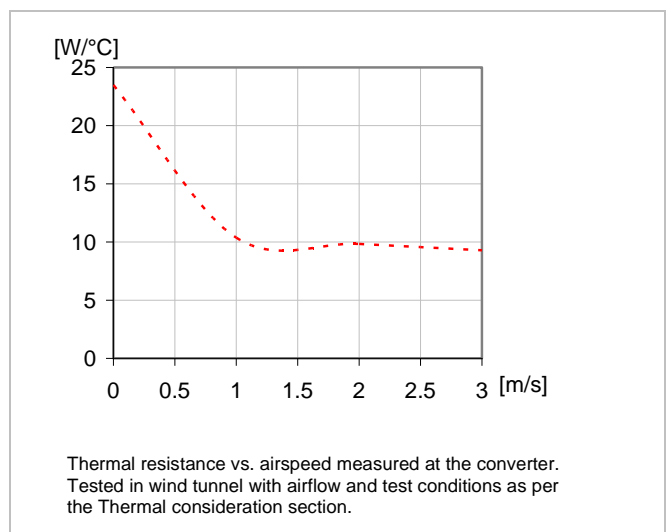

**PKE3000 series DC-DC Converters**  
 Input 9 - 36 V, Output up to 7 A / 30 W

28701- BMR7103000 Rev. L March 2022  
 © Flex

**Typical Characteristics**  
**12 V, 1.25 A / 15 W**

**PKE3213PI(P)**

**Start-up**

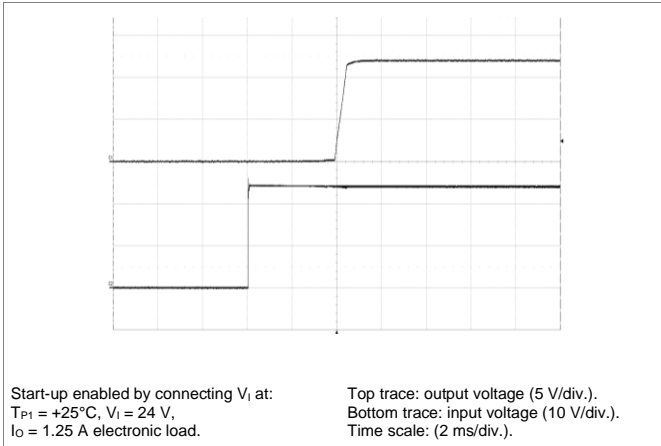

**Shut-down**

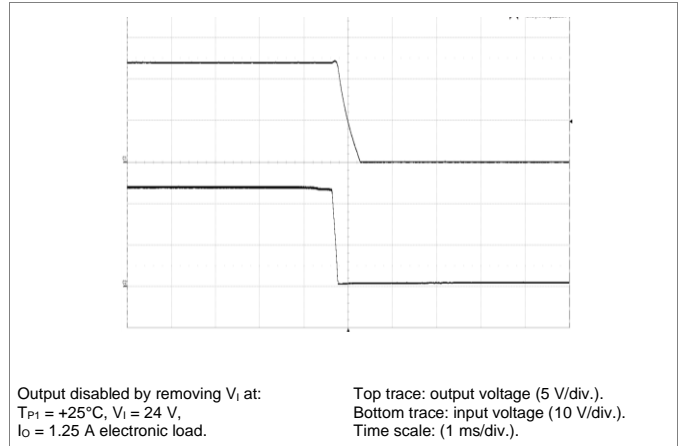

**Output Ripple & Noise**

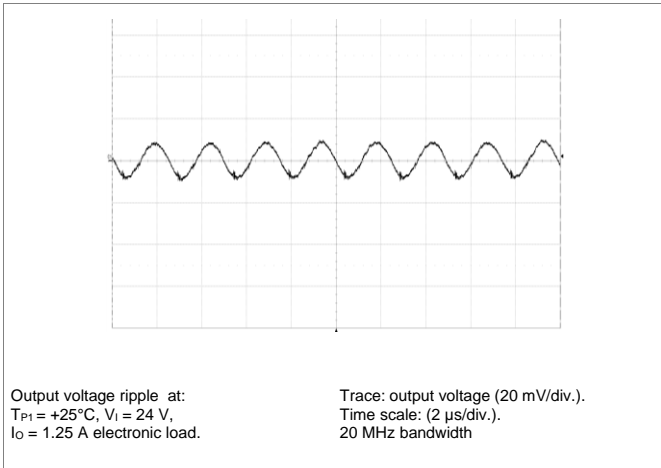

**Output Load Transient Response**

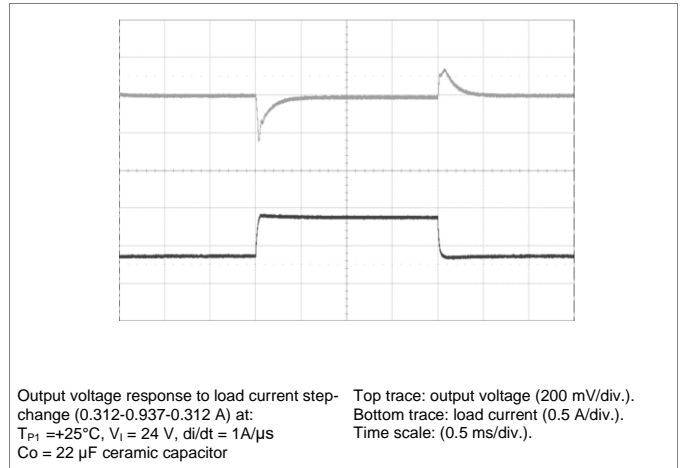

**Output Voltage Adjust (see operating information)**

**Passive adjust**

The resistor value for an adjusted output voltage is calculated by using the following equations:

To adjust the output voltage upwards, a resistor is connected between pins 5 and 6. The output voltage increases when the resistance decreases. The resistance value is given by the equation:  
 $R_{ou} = 22 \times (1.1633V_{oi} - V_{od}) / (V_{od} - V_{oi})$ , (KOhm);  $V_{od}$  is the desired output voltage and  $V_{oi}$  is the initial output voltage.

To adjust the output voltage downwards, a resistor is connected between pins 4 and 5. The output voltage decreases when the resistance decreases. The resistance value is given by the equation:

$R_{od} = 25.5924 \times (1.1390V_{od} - V_{oi}) / (V_{oi} - V_{od})$ , (KOhm);  $V_{od}$  is the desired output voltage and  $V_{oi}$  is the initial output voltage.

## Technical Specification

**PKE3000 series DC-DC Converters**  
Input 9 - 36 V, Output up to 7 A / 30 W

28701- BMR7103000 Rev. L

March 2022

© Flex

**Electrical Specification**  
**15 V, 1 A / 15 W**

PKE3215PI(P)

$T_{P1} = -40$  to  $+90^{\circ}\text{C}$ ,  $V_I = 9$  to  $36$  V, unless otherwise specified under Conditions.

Typical values given at:  $T_{P1} = +25^{\circ}\text{C}$ ,  $V_I = 24$  V, max  $I_O$ , unless otherwise specified under Conditions.

Additional  $C_{out} = 22$   $\mu\text{F}$  ceramic capacitor. See Operating Information section for selection of capacitor types.

Characteristics		Conditions	min	typ	max	Unit
$V_I$	Input voltage range		9		36	V
$V_{loff}$	Turn-off input voltage	Decreasing input voltage	6.5	7.0	8.0	V
$V_{lon}$	Turn-on input voltage	Increasing input voltage	7.5	8.1	8.8	V
$C_I$	Internal input capacitance			10		$\mu\text{F}$
$P_O$	Output power		0		15	W
$\eta$	Efficiency	50% of max $I_O$ , $V_I = 24\text{V}$		85.8		%
		max $I_O$ , $V_I = 24\text{V}$		88.8		
		50% of max $I_O$ , $V_I = 12\text{V}$		88.1		
		max $I_O$ , $V_I = 12\text{V}$		87.5		
$P_d$	Power Dissipation	max $I_O$		1.9	5.0	W
$P_{li}$	Input idling power	$I_O = 0$ A, $V_I = 24$ V		0.460		W
$P_{RC}$	Input standby power	$V_I = 24$ V (turned off with RC)		0.240		W
$f_s$	Switching frequency	0-100 % of max $I_O$	340	400	460	kHz

$V_{Oi}$	Output voltage initial setting and accuracy	$T_{P1} = +25^{\circ}\text{C}$ , $V_I = 24$ V, $I_O = 1$ A	14.82	15.00	15.18	V
$V_O$	Output adjust range	See operating information	13.50		16.50	V
	Output voltage tolerance band	10-100% of max $I_O$	14.4		15.6	V
	Idling voltage	$I_O = 0$ A	14		16	V
	Line regulation	max $I_O$		2	30	mV
	Load regulation	$V_I = 24$ V, 10-100% of max $I_O$		4	150	mV
$V_{tr}$	Load transient voltage deviation	$V_I = 24$ V, Load step 25-75-25% of max $I_O$ , $di/dt = 1$ A/ $\mu\text{s}$		$\pm 230$	$\pm 700$	mV
$t_{tr}$	Load transient recovery time			200	500	$\mu\text{s}$
$t_r$	Ramp-up time (from 10-90% of $V_{Oi}$ )	10-100% of max $I_O$	0.1	1.08	5	ms
$t_s$	Start-up time (from $V_I$ connection to 90% of $V_{Oi}$ )		1	7.7	30	ms
$t_f$	$V_I$ shut-down fall time (from $V_I$ off to 10% of $V_O$ )	max $I_O$		0.77		ms
		$I_O = 0$ A		0.58		s
$t_{RC}$	RC start-up time	max $I_O$		6.8		ms
	RC shut-down fall time (from RC off to 10% of $V_O$ )	max $I_O$		0.57		ms
		$I_O = 0$ A		0.56		s
$I_O$	Output current		0.1		1.0	A
$I_{lim}$	Current limit threshold	$V_I = 24$ V, $T_{P1} < \text{max } T_{P1}$	1.1	1.8	2.5	A
$I_{sc}$	Short circuit current	$T_{P1} = 25^{\circ}\text{C}$ , see Note 1		1.5		A
$C_{out}$	Recommended Capacitive Load	$T_{P1} = 25^{\circ}\text{C}$ , $V_I = 24$ V, see Note 2	0		470	$\mu\text{F}$
$V_{Oac}$	Output ripple & noise	See ripple & noise section, $V_{Oi}$		22	44	mVp-p
OVP	Over voltage protection	$T_{P1} = +25^{\circ}\text{C}$ , $V_I = 24$ V, 0-100% of max $I_O$		18		V
RC	Sink current, see Note 3	See operating information	10			mA
	Trigger level	See operating information	2.5			V

Note 1: Output current (RMS), hiccup mode

Note 2: Test condition: Electrolytic Capacitor with 10% - full load

Note 3: Sink current drawn by external device connected to the RC pin. Minimum sink current required to guarantee activated RC function.

**PKE3000 series DC-DC Converters**  
 Input 9 - 36 V, Output up to 7 A / 30 W

28701- BMR7103000 Rev. L

March 2022

© Flex

**Typical Characteristics**  
**15 V, 1 A / 15 W**

**PKE3215PI(P)**

**Efficiency**

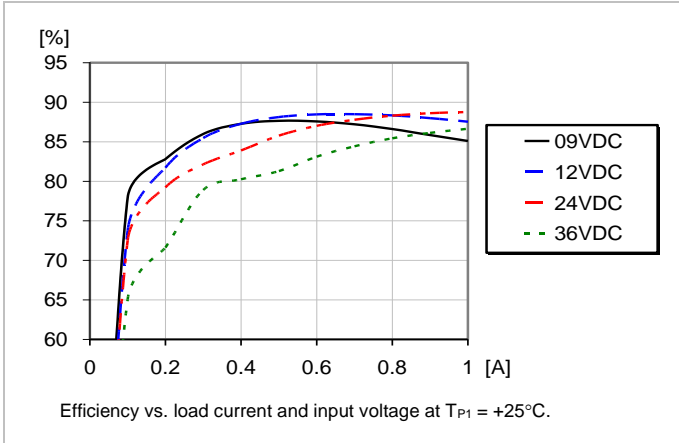

**Power Dissipation**

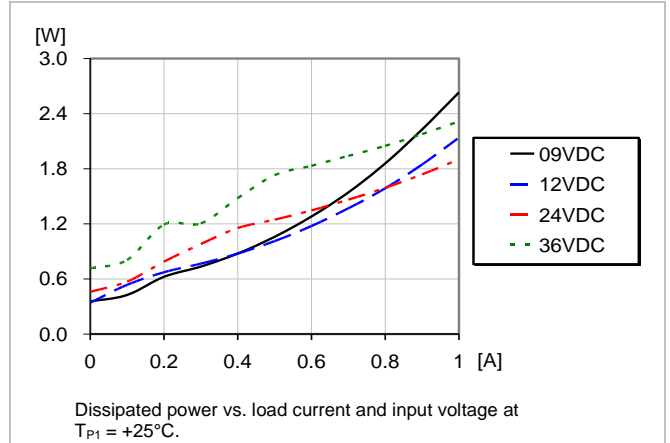

**Output Characteristics**

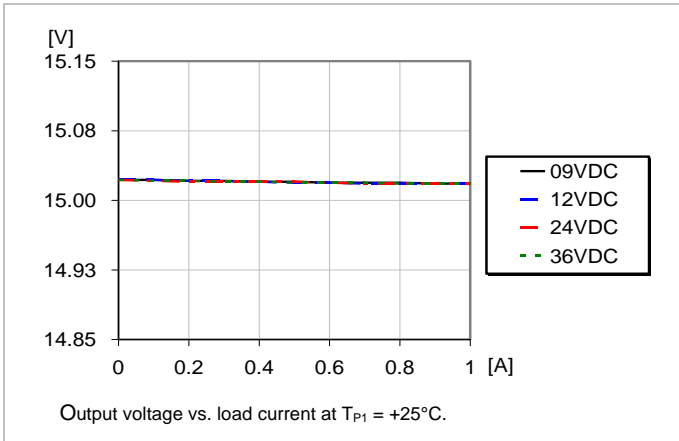

**Current Limit Characteristics**

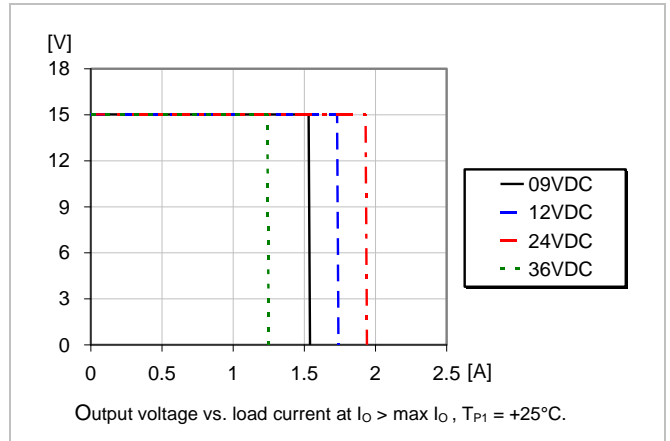

**Output Current Derating**

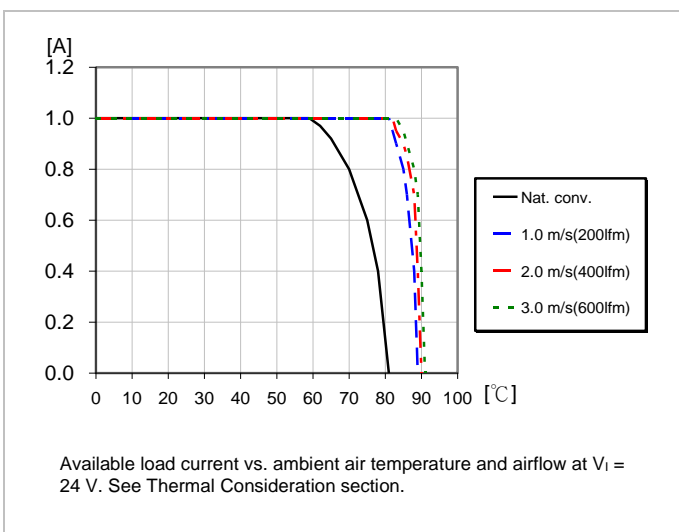

**Thermal Resistance**

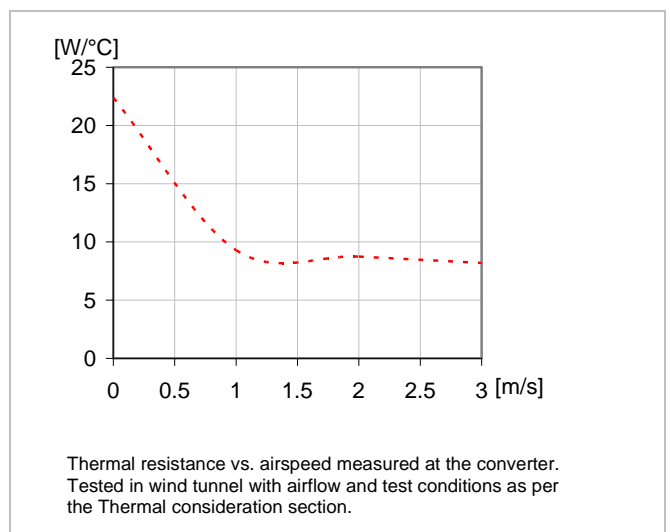

**PKE3000 series DC-DC Converters**  
 Input 9 - 36 V, Output up to 7 A / 30 W

28701- BMR7103000 Rev. L March 2022  
 © Flex

**Typical Characteristics**  
 15 V, 1 A / 15 W

**PKE3215PI(P)**

**Start-up**

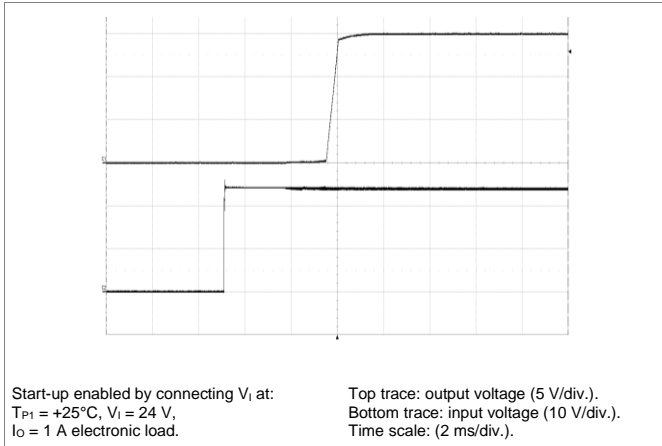

**Shut-down**

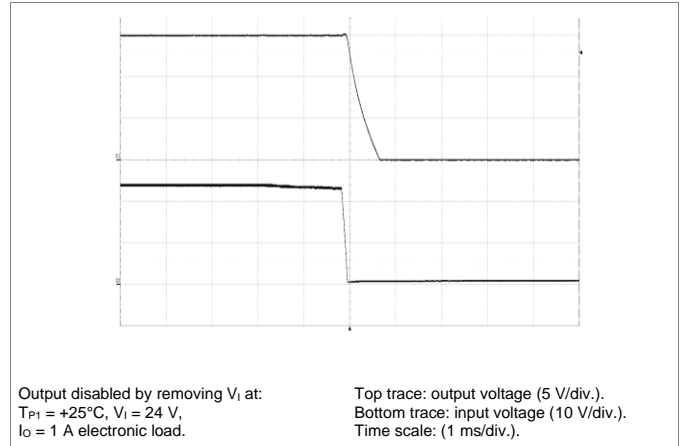

**Output Ripple & Noise**

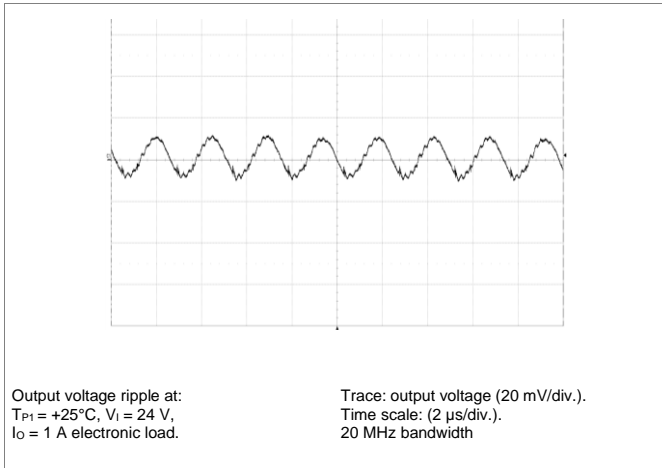

**Output Load Transient Response**

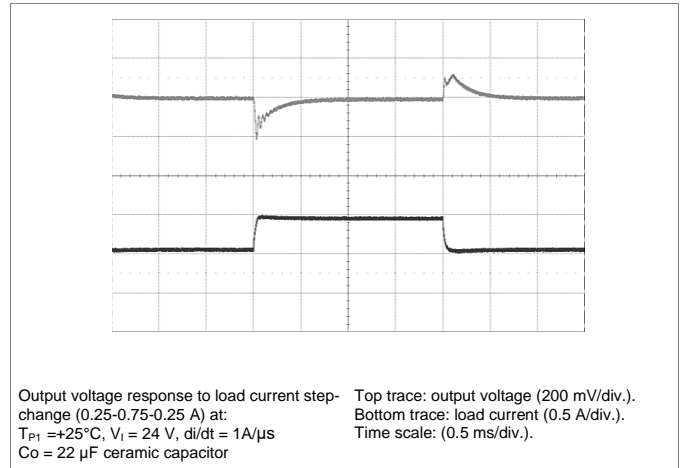

**Output Voltage Adjust (see operating information)**

**Passive adjust**

The resistor value for an adjusted output voltage is calculated by using the following equations:

To adjust the output voltage upwards, a resistor is connected between pins 5 and 6. The output voltage increases when the resistance decreases. The resistance value is given by the equation:  
 $R_{ou} = 30 \times (1.1499V_{oi} - V_{od}) / (V_{od} - V_{oi})$ , (KOhm);  $V_{od}$  is the desired output voltage and  $V_{oi}$  is the initial output voltage.

To adjust the output voltage downwards, a resistor is connected between pins 4 and 5. The output voltage decreases when the resistance decreases. The resistance value is given by the equation:

$R_{od} = 34.497 \times (1.1331V_{od} - V_{oi}) / (V_{oi} - V_{od})$ , (KOhm);  $V_{od}$  is the desired output voltage and  $V_{oi}$  is the initial output voltage.



## Technical Specification

**PKE3000 series DC-DC Converters**  
Input 9 - 36 V, Output up to 7 A / 30 W

28701- BMR7103000 Rev. L

March 2022

© Flex

### Electrical Specification

#### 3.3 V, 7 A / 23.1 W

**PKE3310PI(P)**

$T_{P1} = -40$  to  $115^{\circ}\text{C}$ ,  $V_I = 9$  to  $36$  V, unless otherwise specified under Conditions.

Typical values given at:  $T_{P1} = +25^{\circ}\text{C}$ ,  $V_I = 24$  V, max  $I_O$ , unless otherwise specified under Conditions.

Additional  $C_{in} = 220$   $\mu\text{F}$ ,  $C_{out} = 0.1$   $\mu\text{F}$  ceramic Cap. +  $10$   $\mu\text{F}$  E-Cap. See Operating Information section for selection of capacitor types.

Characteristics		Conditions	min	typ	max	Unit
$V_I$	Input voltage range		9		36	V
$V_{loff}$	Turn-off input voltage	Decreasing input voltage	7.0	7.5	8.0	V
$V_{lon}$	Turn-on input voltage	Increasing input voltage	8.0	8.5	9.0	V
$C_I$	Internal input capacitance			33		$\mu\text{F}$
$P_O$	Output power		0		23.1	W
$\eta$	Efficiency	50% of max $I_O$ , $V_I = 12$ V		88		%
		max $I_O$ , $V_I = 12$ V		87		
		50% of max $I_O$ , $V_I = 24$ V		87		
		max $I_O$ , $V_I = 24$ V		88		
$P_d$	Power Dissipation	max $I_O$		3	4.6	W
$P_{ii}$	Input idling power	$I_O = 0$ A, $V_I = 24$ V		0.2		W
$P_{RC}$	Input standby power	$V_I = 24$ V (turned off with RC)		0.1		W
$f_s$	Switching frequency	0-100 % of max $I_O$	238	280	322	kHz

$V_{oi}$	Output voltage initial setting and accuracy	$T_{P1} = +25^{\circ}\text{C}$ , $V_I = 24$ V, $I_O = 1.25$ A	3.267	3.3	3.333	V
$V_O$	Output adjust range	See operating information	2.97	3.3	3.63	V
	Output voltage tolerance band	0-100% of max $I_O$	3.201		3.399	V
	Idling voltage	$I_O = 0$ A	3.201		3.399	V
	Line regulation	max $I_O$		5.5	6.6	mV
	Load regulation	$V_I = 24$ V, 0-100% of max $I_O$		26	33	mV
$V_{tr}$	Load transient voltage deviation	$V_I = 24$ V, Load step 50-75-50% of max $I_O$ , $di/dt = 100$ mA/ $\mu\text{s}$		$\pm 275$	$\pm 500$	mV
$t_{tr}$	Load transient recovery time			250	500	$\mu\text{s}$
$t_r$	Ramp-up time (from 10-90% of $V_{oi}$ )	100% of max $I_O$		5	10	ms
$t_s$	Start-up time (from $V_I$ connection to 90% of $V_{oi}$ )			8	15	ms
$t_{RC}$	RC start-up time (from $V_{RC}$ connection to 90% of $V_{oi}$ )	max $I_O$		2	5	ms
RC	Sink current	See operating information	10			mA
	Trigger level	Decreasing / Increasing RC-voltage		0.8/2.5		V
$I_O$	Output current		0		7	A
$I_{lim}$	Current limit threshold	$V_I = 24$ V, $T_{P1} < \text{max } T_{P1}$		11.8	14	A
$I_{sc}$	Short circuit current	$T_{P1} = 25^{\circ}\text{C}$ , see Note 1		1.97		A
$C_{out}$	Recommended Capacitive Load	$T_{P1} = 25^{\circ}\text{C}$	0		15000	$\mu\text{F}$
$V_{Oac}$	Output ripple & noise	See ripple & noise section, $V_{oi}$ , max $I_O$ , see Note 2		12	24	mVp-p
OVP	Over voltage protection	$T_{P1} = +25^{\circ}\text{C}$ , $V_I = 24$ V, 0-100% of max $I_O$		4.3		V

Note 1: Output current (RMS), hiccup mode

Note 2: Measured with 0.1  $\mu\text{F}$  ceramic Cap. and 10  $\mu\text{F}$  tantalum (or EE) Cap. cross to output.

**PKE3000 series DC-DC Converters**  
 Input 9 - 36 V, Output up to 7 A / 30 W

28701- BMR7103000 Rev. L March 2022  
 © Flex

**Typical Characteristics**  
**3.3 V, 7 A / 23.1 W**

**PKE3310PI(P)**

**Efficiency**

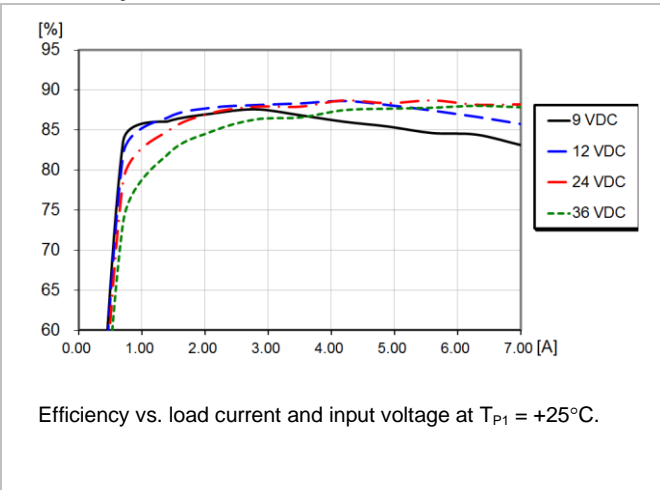

**Power Dissipation**

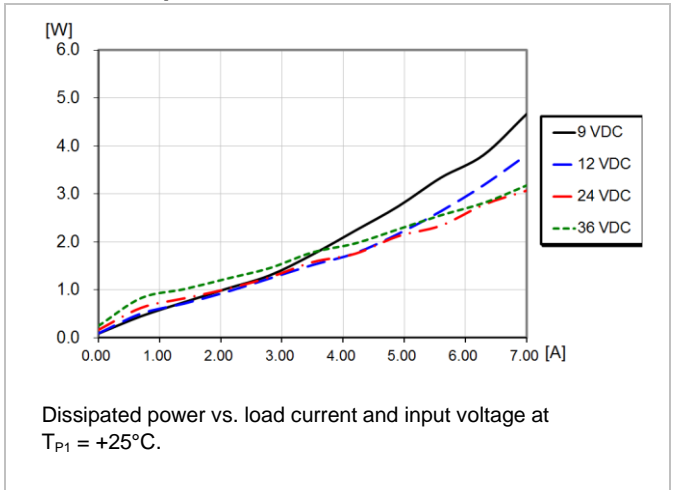

**Output Current Derating**

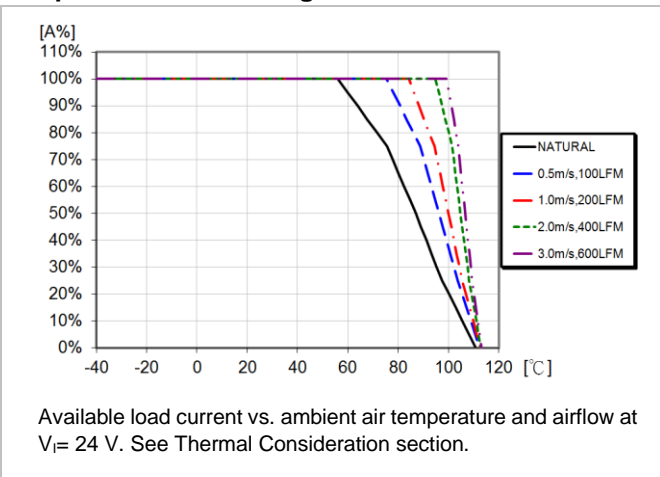

**Current Limit Characteristics**

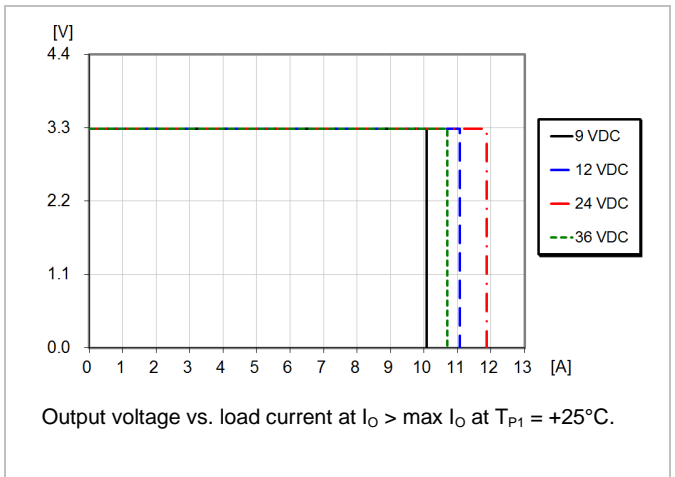

**PKE3000 series DC-DC Converters**  
 Input 9 - 36 V, Output up to 7 A / 30 W

28701- BMR7103000 Rev. L March 2022  
 © Flex

**Typical Characteristics**  
**3.3 V, 7 A / 23.1 W**

**PKE3310PI(P)**

**Start-up**

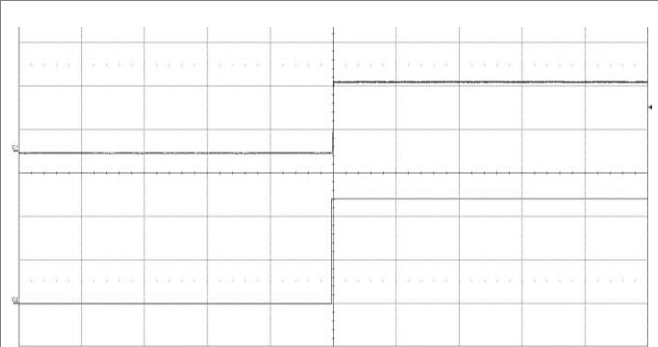

Start-up enabled by connecting  $V_I$  at:  
 $T_{P1} = +25^{\circ}\text{C}$ ,  $V_I = 24\text{ V}$ ,  
 $I_O = 7\text{ A}$  resistive load.  
 Top trace: output voltage (2 V/div.).  
 Bottom trace: input voltage (10 V/div.).  
 Time scale: (200 ms/div.).

**Shut-down**

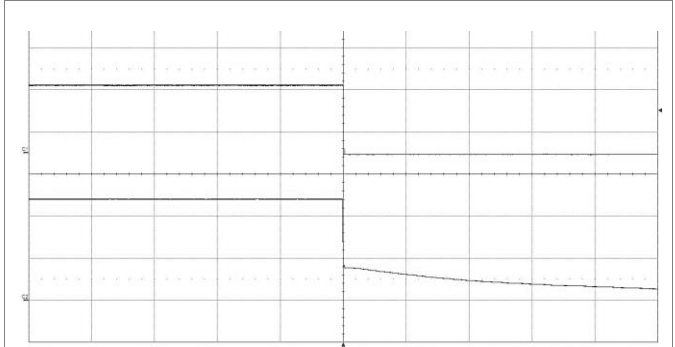

Output disabled by removing  $V_I$  at:  
 $T_{P1} = +25^{\circ}\text{C}$ ,  $V_I = 24\text{ V}$ ,  
 $I_O = 7\text{ A}$  resistive load.  
 Top trace: output voltage (2 V/div.).  
 Bottom trace: input voltage (10 V/div.).  
 Time scale: (200 ms/div.).

**Output Ripple & Noise**

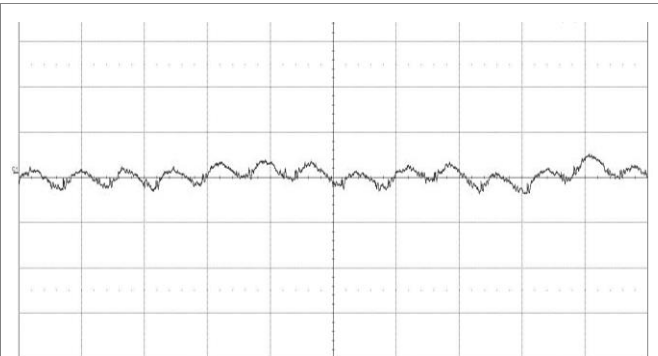

Output voltage ripple at:  
 $T_{P1} = +25^{\circ}\text{C}$ ,  $V_I = 24\text{ V}$ ,  
 $I_O = 7\text{ A}$  resistive load.  
 Trace: output voltage (10 mV/div.).  
 Time scale: (5 μs/div.)  
 20 MHz bandwidth

**Output Load Transient Response**

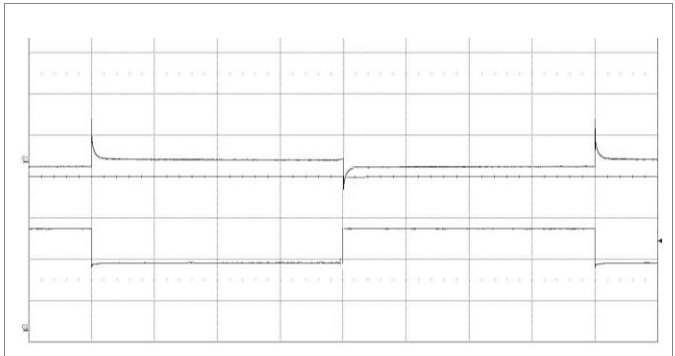

Output voltage response to load current step-change (3.5-5.25-3.5 A) at:  
 $T_{P1} = +25^{\circ}\text{C}$ ,  $V_I = 24\text{ V}$ .  
 Top trace: output voltage (200 mV/div.).  
 Bottom trace: load current (2 A/div.).  
 Time scale: (2 ms/div.).

**Output Voltage Adjust (TRIM UP/TRIM DOWN)**

**Output Voltage = 3.3V**

The resistor value for an adjusted output voltage is calculated by using the following equations:

Output Voltage Adjust, Increase:

$$R_{\text{ADJ\_UP}} = \left( \frac{1.9528}{\Delta} - 12 \right) \text{ k}\Omega$$

Output Voltage Adjust, Decrease:

$$R_{\text{ADJ\_DOWN}} = \left( \frac{1.8627}{\Delta} - 15.815 \right) \text{ k}\Omega$$

Example:

To trim up the 3.3 V model by 8% to 3.56 V the required external resistor is:

$$R_{\text{ADJ\_UP}} = \left( \frac{1.9528}{0.08} - 12 \right) = 12.41 \text{ k}\Omega$$

Example:

To trim down the 3.3 V model by 7% to 3.07 V the required external resistor is:

$$R_{\text{ADJ\_DOWN}} = \left( \frac{1.8627}{0.07} - 15.815 \right) = 10.79 \text{ k}\Omega$$

## Technical Specification

**PKE3000 series DC-DC Converters**  
Input 9 - 36 V, Output up to 7 A / 30 W

28701- BMR7103000 Rev. L March 2022  
© Flex

**Electrical Specification**  
**5 V, 6 A / 30 W**

**PKE3311PI(P)**

$T_{P1} = -40$  to  $115^{\circ}\text{C}$ ,  $V_I = 9$  to  $36$  V, unless otherwise specified under Conditions.

Typical values given at:  $T_{P1} = +25^{\circ}\text{C}$ ,  $V_I = 24$  V, max  $I_O$ , unless otherwise specified under Conditions.

Additional  $C_{in} = 220$   $\mu\text{F}$ ,  $C_{out} = 0.1$   $\mu\text{F}$  ceramic Cap. +  $10$   $\mu\text{F}$  E-Cap. See Operating Information section for selection of capacitor types.

Characteristics		Conditions	min	typ	max	Unit
$V_I$	Input voltage range		9		36	V
$V_{loff}$	Turn-off input voltage	Decreasing input voltage	7.0	7.5	8.0	V
$V_{lon}$	Turn-on input voltage	Increasing input voltage	8.0	8.5	9.0	V
$C_I$	Internal input capacitance			33		$\mu\text{F}$
$P_O$	Output power		0		30	W
$\eta$	Efficiency	50% of max $I_O$ , $V_I = 12$ V		90		%
		max $I_O$ , $V_I = 12$ V		88		
		50% of max $I_O$ , $V_I = 24$ V		89		
		max $I_O$ , $V_I = 24$ V		90		
$P_d$	Power Dissipation	max $I_O$		3.3	5.5	W
$P_{li}$	Input idling power	$I_O = 0$ A, $V_I = 24$ V		0.2		W
$P_{RC}$	Input standby power	$V_I = 24$ V (turned off with RC)		0.1		W
$f_s$	Switching frequency	0-100 % of max $I_O$	238	280	322	kHz

$V_{oi}$	Output voltage initial setting and accuracy	$T_{P1} = +25^{\circ}\text{C}$ , $V_I = 24$ V, $I_O = 7$ A	4.95	5	5.05	V
$V_O$	Output adjust range	See operating information	4.5	5	5.5	V
	Output voltage tolerance band	0-100% of max $I_O$	4.85		5.15	V
	Idling voltage	$I_O = 0$ A	4.85		5.15	V
	Line regulation	max $I_O$		5	10	mV
	Load regulation	$V_I = 24$ V, 0-100% of max $I_O$		30	50	mV
$V_{tr}$	Load transient voltage deviation	$V_I = 24$ V, Load step 50-75-50% of max $I_O$ , $di/dt = 100$ mA/ $\mu\text{s}$		$\pm 275$	$\pm 500$	mV
$t_{tr}$	Load transient recovery time			250	500	$\mu\text{s}$
$t_r$	Ramp-up time (from 10-90% of $V_{oi}$ )	100% of max $I_O$		5	10	ms
$t_s$	Start-up time (from $V_I$ connection to 90% of $V_{oi}$ )			8	15	ms
$t_{RC}$	RC start-up time (from $V_{RC}$ connection to 90% of $V_{oi}$ )	max $I_O$		2	5	ms
RC	Sink current	See operating information	10			mA
	Trigger level	Decreasing / Increasing RC-voltage		0.8/2.5		V
$I_O$	Output current		0		6	A
$I_{lim}$	Current limit threshold	$V_I = 24$ V, $T_{P1} < \text{max } T_{P1}$		9.6	12	A
$I_{sc}$	Short circuit current	$T_{P1} = 25^{\circ}\text{C}$ , See Note 1		1.57		A
$C_{out}$	Recommended Capacitive Load	$T_{P1} = 25^{\circ}\text{C}$	0		8000	$\mu\text{F}$
$V_{Oac}$	Output ripple & noise	See ripple & noise section, $V_{oi}$ , max $I_O$ , see Note 2		22	24	mVp-p
OVP	Over voltage protection	$T_{P1} = +25^{\circ}\text{C}$ , $V_I = 24$ V, 0-100% of max $I_O$		6.2		V

Note 1: Output current (RMS), hiccup mode

Note 2: Measured with 0.1  $\mu\text{F}$  ceramic Cap. and 10  $\mu\text{F}$  tantalum (or EE) Cap. cross to output.

**PKE3000 series DC-DC Converters**  
 Input 9 - 36 V, Output up to 7 A / 30 W

28701- BMR7103000 Rev. L

March 2022

© Flex

**Typical Characteristics**  
**5 V, 6 A / 30 W**

**PKE3311PI(P)**

**Efficiency**

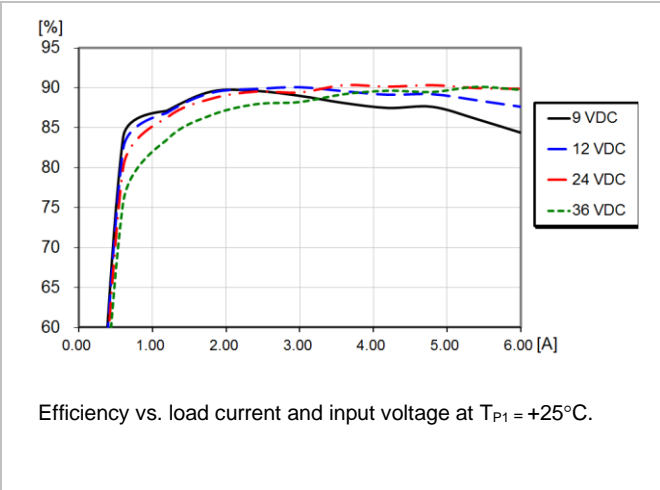

**Power Dissipation**

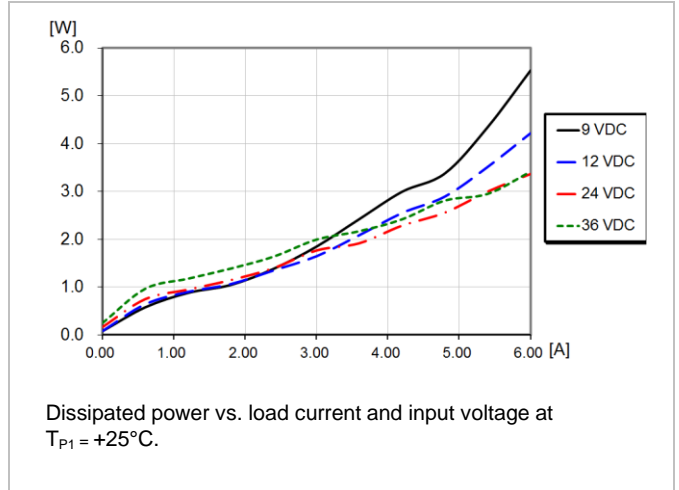

**Output Current Derating**

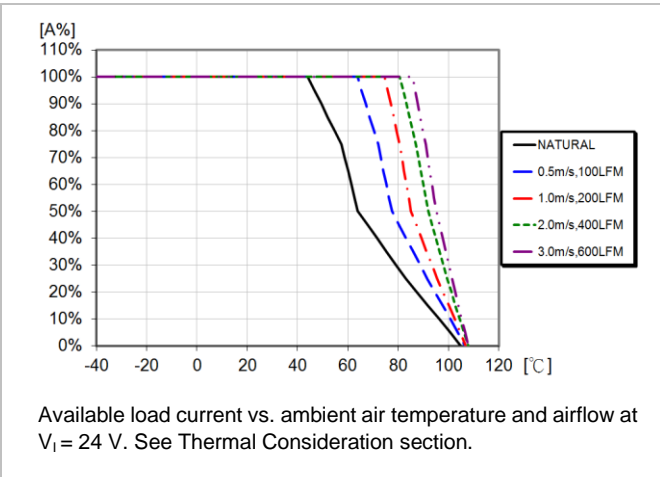

**Current Limit Characteristics**

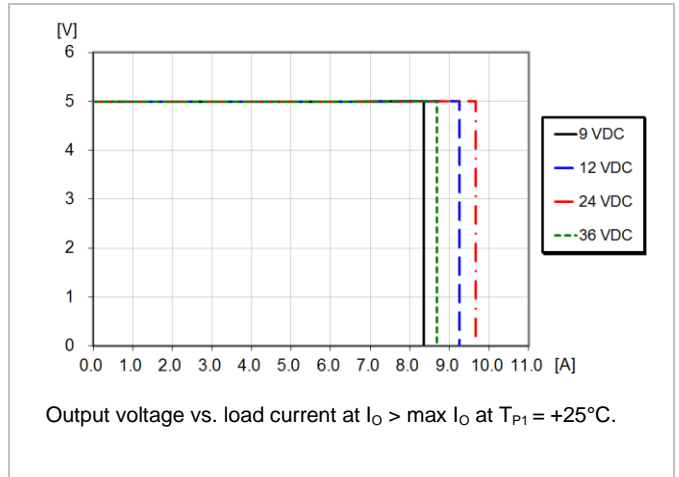

**PKE3000 series DC-DC Converters**  
 Input 9 - 36 V, Output up to 7 A / 30 W

28701- BMR7103000 Rev. L March 2022  
 © Flex

**Typical Characteristics**  
**5 V, 6 A / 30 W**

**PKE3311PI(P)**

**Start-up**

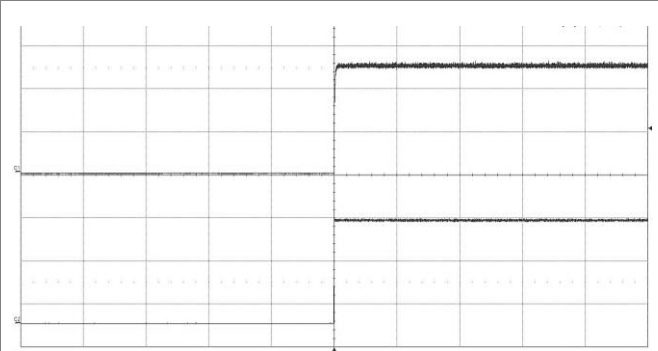

Start-up enabled by connecting  $V_I$  at:  
 $T_{P1} = +25^\circ\text{C}$ ,  $V_I = 24\text{ V}$ ,  
 $I_O = 6\text{ A}$  resistive load.  
 Top trace: output voltage (2 V/div.).  
 Bottom trace: input voltage (10 V/div.).  
 Time scale: (200 ms/div.).

**Shut-down**

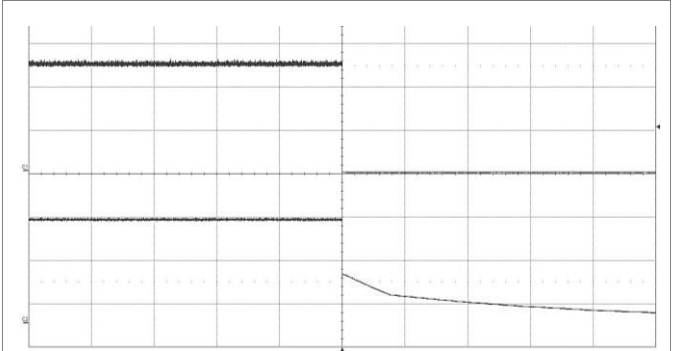

Output voltage disabled by removing  $V_I$  at:  
 $T_{P1} = +25^\circ\text{C}$ ,  $V_I = 24\text{ V}$ ,  
 $I_O = 6\text{ A}$  resistive load.  
 Top trace: output voltage (2 V/div.).  
 Bottom trace: input voltage (10 V/div.).  
 Time scale: (200 ms/div.).

**Output Ripple & Noise**

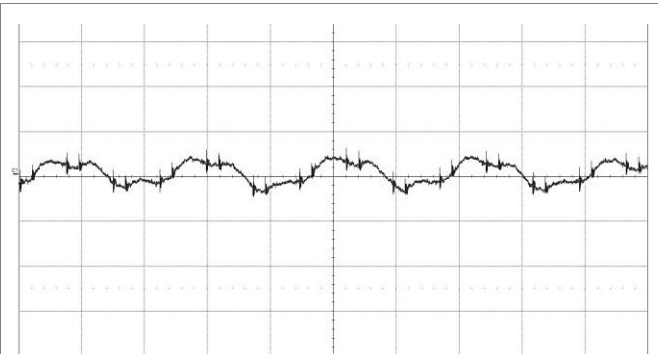

Output voltage ripple at:  
 $T_{P1} = +25^\circ\text{C}$ ,  $V_I = 24\text{ V}$ ,  
 $I_O = 6\text{ A}$  resistive load.  
 Trace: output voltage (20 mV/div.).  
 Time scale: (5 μs/div.)  
 20 MHz bandwidth

**Output Load Transient Response**

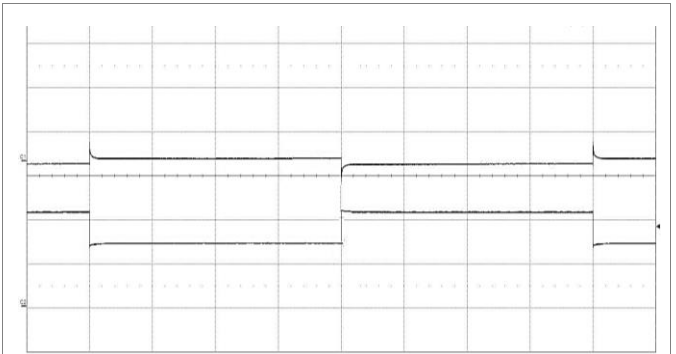

Output voltage response to load current step-change (3.0-4.5-3.0 A) at:  
 $T_{P1} = +25^\circ\text{C}$ ,  $V_I = 24\text{ V}$ .  
 Top trace: output voltage (500 mV/div.).  
 Bottom trace: load current (2 A/div.).  
 Time scale: (2 ms/div.).

**Output Voltage Adjust (TRIM UP/TRIM DOWN)**

**Output Voltage = 5.0 V**

The resistor value for an adjusted output voltage is calculated by using the following equations:

Output Voltage Adjust, Increase:

$$R_{\text{ADJ\_UP}} = \left( \frac{1.5}{\Delta} - 10 \right) \text{ k}\Omega$$

Output Voltage Adjust, Decrease:

$$R_{\text{ADJ\_DOWN}} = \left( \frac{1.5}{\Delta} - 13 \right) \text{ k}\Omega$$

Example:

To trim up the 5.0 V model by 8% to 5.4 V the required external resistor is:

$$R_{\text{ADJ\_UP}} = \left( \frac{1.5}{0.08} - 10 \right) = 8.75 \text{ k}\Omega$$

Example:

To trim down the 5.0 V model by 7% to 4.65 V the required external resistor is:

$$R_{\text{ADJ\_DOWN}} = \left( \frac{1.5}{0.07} - 13 \right) = 8.43 \text{ k}\Omega$$

## Technical Specification

**PKE3000 series DC-DC Converters**  
Input 9 - 36 V, Output up to 7 A / 30 W

28701- BMR7103000 Rev. L

March 2022

© Flex

**Electrical Specification**  
**12 V, 2.5 A / 30 W**

**PKE3313PI(P)**

$T_{P1} = -40$  to  $115^{\circ}\text{C}$ ,  $V_I = 9$  to  $36$  V, unless otherwise specified under Conditions.

Typical values given at:  $T_{P1} = +25^{\circ}\text{C}$ ,  $V_I = 24$  V, max  $I_O$ , unless otherwise specified under Conditions.

Additional  $C_{in} = 220$   $\mu\text{F}$ ,  $C_{out} = 0.1$   $\mu\text{F}$  ceramic Cap. +  $10$   $\mu\text{F}$  E-Cap. See Operating Information section for selection of capacitor types.

Characteristics		Conditions	min	typ	max	Unit
$V_I$	Input voltage range		9		36	V
$V_{loff}$	Turn-off input voltage	Decreasing input voltage	7.0	7.5	8.0	V
$V_{lon}$	Turn-on input voltage	Increasing input voltage	8.0	8.5	9.0	V
$C_I$	Internal input capacitance			33		$\mu\text{F}$
$P_O$	Output power		0		30	W
$\eta$	Efficiency	50% of max $I_O$ , $V_I = 12$ V		91		%
		max $I_O$ , $V_I = 12$ V		90		
		50% of max $I_O$ , $V_I = 24$ V		91		
		max $I_O$ , $V_I = 24$ V		92		
$P_d$	Power Dissipation	max $I_O$		2.5	4	W
$P_{li}$	Input idling power	$I_O = 0$ A, $V_I = 24$ V		0.2		W
$P_{RC}$	Input standby power	$V_I = 24$ V (turned off with RC)		0.1		W
$f_s$	Switching frequency	0-100 % of max $I_O$	238	280	322	kHz

$V_{O1}$	Output voltage initial setting and accuracy	$T_{P1} = +25^{\circ}\text{C}$ , $V_I = 24$ V, $I_O = 6$ A	11.88	12	12.12	V
$V_O$	Output adjust range	See operating information	10.8	12	13.2	V
	Output voltage tolerance band	0-100% of max $I_O$	11.64		12.36	V
	Idling voltage	$I_O = 0$ A	11.64		12.36	V
	Line regulation	max $I_O$		12	24	mV
	Load regulation	$V_I = 24$ V, 0-100% of max $I_O$		60	120	mV
$V_{tr}$	Load transient voltage deviation	$V_I = 24$ V, Load step 50-75-50% of max $I_O$ , $di/dt = 100$ mA/ $\mu\text{s}$		$\pm 275$	$\pm 500$	mV
$t_{tr}$	Load transient recovery time			250	500	$\mu\text{s}$
$t_r$	Ramp-up time (from 10-90% of $V_{O1}$ )	100% of max $I_O$		5	10	ms
$t_s$	Start-up time (from $V_I$ connection to 90% of $V_{O1}$ )			8	15	ms
$t_{RC}$	RC start-up time (from $V_{RC}$ connection to 90% of $V_{O1}$ )	max $I_O$		2	5	ms
RC	Sink current	See operating information	10			mA
	Trigger level	Decreasing / Increasing RC-voltage		0.8/2.5		V
$I_O$	Output current		0		2.5	A
$I_{lim}$	Current limit threshold	$V_I = 24$ V, $T_{P1} < \text{max } T_{P1}$		4.2	5.0	A
$I_{sc}$	Short circuit current	$T_{P1} = 25^{\circ}\text{C}$ , see Note 1		1.14		A
$C_{out}$	Recommended Capacitive Load	$T_{P1} = 25^{\circ}\text{C}$	0		3000	$\mu\text{F}$
$V_{Oac}$	Output ripple & noise	See ripple & noise section, $V_{O1}$ , max $I_O$ , see Note 2		35	70	mVp-p
OVP	Over voltage protection	$T_{P1} = +25^{\circ}\text{C}$ , $V_I = 24$ V, 0-100% of max $I_O$		15		V

Note 1: Output current (RMS), hiccup mode

Note 2: Measured with 0.1  $\mu\text{F}$  ceramic Cap. and 10  $\mu\text{F}$  tantalum (or EE) Cap. cross to output.

**PKE3000 series DC-DC Converters**  
 Input 9 - 36 V, Output up to 7 A / 30 W

28701- BMR7103000 Rev. L March 2022  
 © Flex

**Typical Characteristics**  
**12 V, 2.5 A / 30 W**

**PKE3313PI(P)**

**Efficiency**

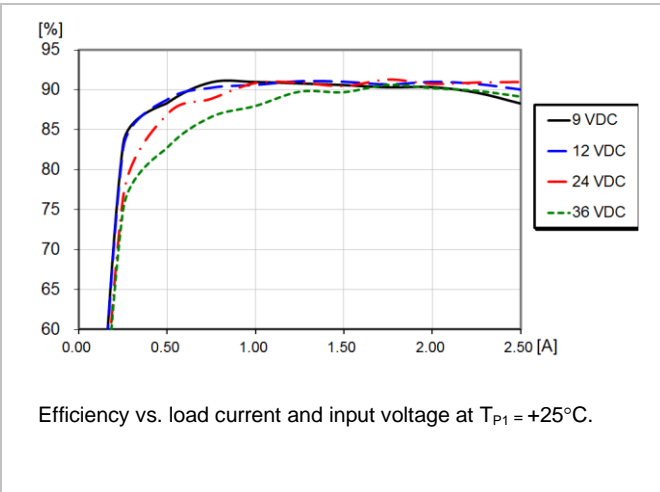

**Power Dissipation**

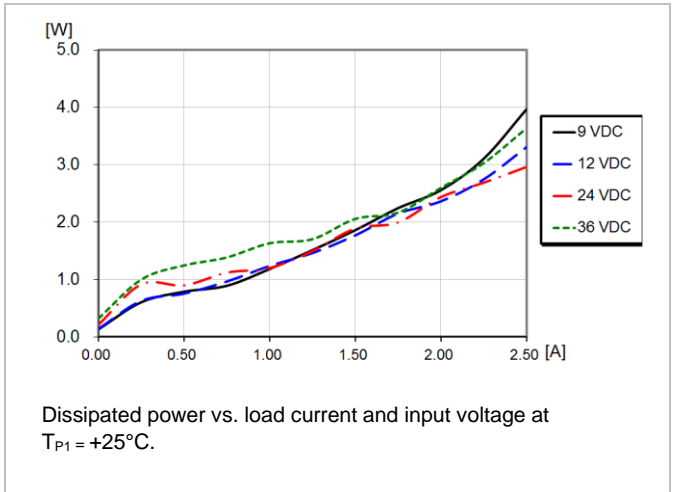

**Output Current Derating**

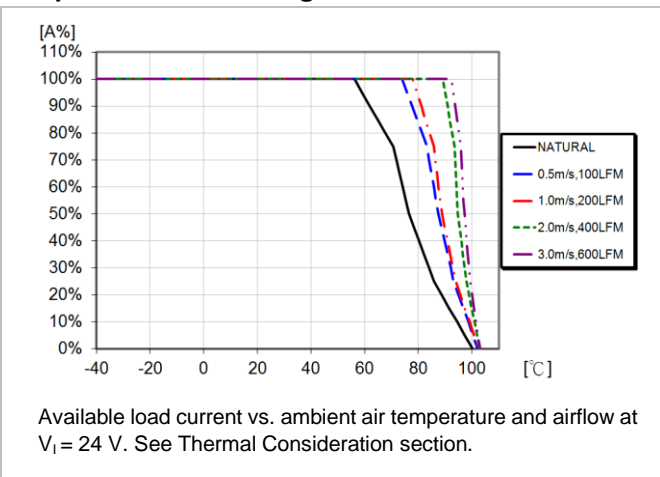

**Current Limit Characteristics**

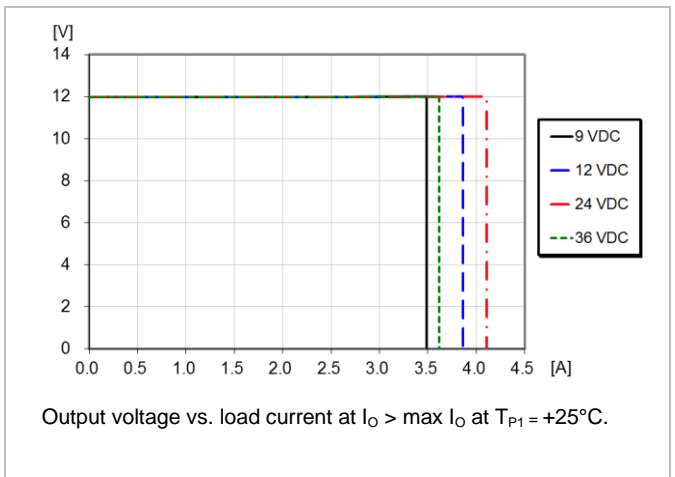



**PKE3000 series DC-DC Converters**  
 Input 9 - 36 V, Output up to 7 A / 30 W

28701- BMR7103000 Rev. L March 2022  
 © Flex

**Typical Characteristics**  
**12 V, 2.5 A / 30 W**

**PKE3313PI(P)**

**Start-up**

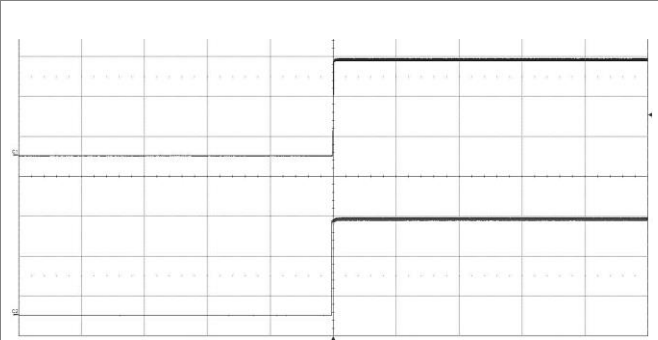

Start-up enabled by connecting  $V_I$  at:  
 $T_{P1} = +25^\circ\text{C}$ ,  $V_I = 24\text{ V}$ ,  
 $I_O = 2.5\text{ A}$  resistive load.  
 Top trace: output voltage (5 V/div.).  
 Bottom trace: input voltage (10 V/div.).  
 Time scale: (200 ms/div.).

**Shut-down**

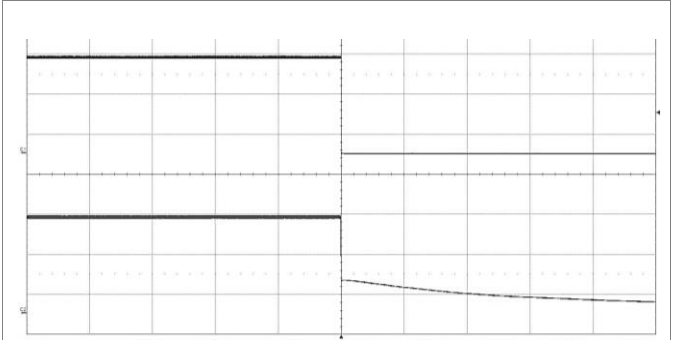

Output disabled by removing  $V_I$  at:  
 $T_{P1} = +25^\circ\text{C}$ ,  $V_I = 24\text{ V}$ ,  
 $I_O = 2.5\text{ A}$  resistive load.  
 Top trace: output voltage (5 V/div.).  
 Bottom trace: input voltage (10 V/div.).  
 Time scale: (200 ms/div.).

**Output Ripple & Noise**

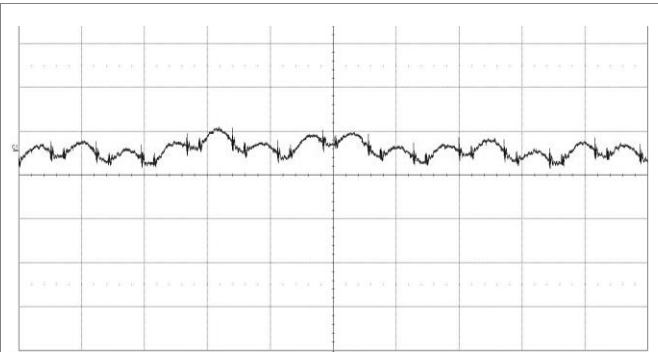

Output voltage ripple at:  
 $T_{P1} = +25^\circ\text{C}$ ,  $V_I = 24\text{ V}$ ,  
 $I_O = 2.5\text{ A}$  resistive load.  
 Trace: output voltage (20 mV/div.).  
 Time scale: (5 μs/div.).  
 20 MHz bandwidth

**Output Load Transient Response**

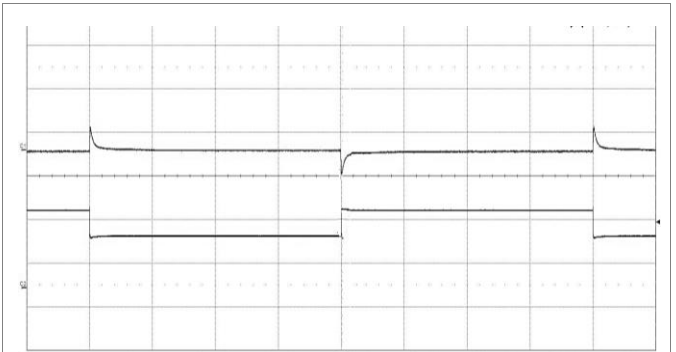

Output voltage response to load current step-change (1.25-1.875-1.25 A) at:  
 $T_{P1} = +25^\circ\text{C}$ ,  $V_I = 24\text{ V}$ .  
 Top trace: output voltage (500 mV/div.).  
 Bottom trace: load current (1 A/div.).  
 Time scale: (2 ms/div.).

**Output Voltage Adjust (TRIM UP/TRIM DOWN)**

**Output Voltage = 12 V**

The resistor value for an adjusted output voltage is calculated by using the following equations:

Output Voltage Adjust, Increase:

$$R_{\text{ADJ\_UP}} = \left( \frac{3.5998}{\Delta} - 24 \right) \text{ k}\Omega$$

Output Voltage Adjust, Decrease:

$$R_{\text{ADJ\_DOWN}} = \left( \frac{3.5796}{\Delta} - 31.179 \right) \text{ k}\Omega$$

Example:

To trim up the 12 V model by 8% to 12.96V the required external resistor is:

$$R_{\text{ADJ\_UP}} = \left( \frac{3.5998}{0.08} - 24 \right) = 21 \text{ k}\Omega$$

Example:

To trim down the 12 V model by 7% to 11.16V the required external resistor is:

$$R_{\text{ADJ\_DOWN}} = \left( \frac{3.5796}{0.07} - 31.179 \right) = 19.96 \text{ k}\Omega$$

## Technical Specification

**PKE3000 series DC-DC Converters**  
Input 9 - 36 V, Output up to 7 A / 30 W

28701- BMR7103000 Rev. L March 2022  
© Flex

**Electrical Specification**  
**15 V, 2 A / 30 W**

**PKE3315PI(P)**

$T_{P1} = -40$  to  $115^{\circ}\text{C}$ ,  $V_I = 9$  to  $36$  V, unless otherwise specified under Conditions.

Typical values given at:  $T_{P1} = +25^{\circ}\text{C}$ ,  $V_I = 24$  V, max  $I_O$ , unless otherwise specified under Conditions.

Additional  $C_{in} = 220$   $\mu\text{F}$ ,  $C_{out} = 0.1$   $\mu\text{F}$  ceramic Cap. +  $10$   $\mu\text{F}$  E-Cap. See Operating Information section for selection of capacitor types.

Characteristics		Conditions	min	typ	max	Unit
$V_I$	Input voltage range		9		36	V
$V_{loff}$	Turn-off input voltage	Decreasing input voltage	7.0	7.5	8.0	V
$V_{lon}$	Turn-on input voltage	Increasing input voltage	8.0	8.5	9.0	V
$C_I$	Internal input capacitance			33		$\mu\text{F}$
$P_O$	Output power		0		30	W
$\eta$	Efficiency	50% of max $I_O$ , $V_I = 12$ V		91		%
		max $I_O$ , $V_I = 12$ V		88		
		50% of max $I_O$ , $V_I = 24$ V		92		
		max $I_O$ , $V_I = 24$ V		91		
$P_d$	Power Dissipation	max $I_O$		2.5	5.2	W
$P_{li}$	Input idling power	$I_O = 0$ A, $V_I = 24$ V		0.2		W
$P_{RC}$	Input standby power	$V_I = 24$ V (turned off with RC)		0.1		W
$f_s$	Switching frequency	0-100 % of max $I_O$	238	280	322	kHz

$V_{oi}$	Output voltage initial setting and accuracy	$T_{P1} = +25^{\circ}\text{C}$ , $V_I = 24$ V, $I_O = 2$ A	14.85	15	15.15	V
$V_O$	Output adjust range	See operating information	13.5	15	16.5	V
	Output voltage tolerance band	0-100% of max $I_O$	14.55		15.45	V
	Idling voltage	$I_O = 0$ A	14.55		15.45	V
	Line regulation	max $I_O$		15	30	mV
	Load regulation	$V_I = 24$ V, 0-100% of max $I_O$		100	150	mV
$V_{tr}$	Load transient voltage deviation	$V_I = 24$ V, Load step 50-75-50% of max $I_O$ , $di/dt = 100$ mA/ $\mu\text{s}$		$\pm 275$	$\pm 500$	mV
$t_{tr}$	Load transient recovery time			250	500	$\mu\text{s}$
$t_r$	Ramp-up time (from 10-90% of $V_{oi}$ )	100% of max $I_O$		5	10	ms
$t_s$	Start-up time (from $V_I$ connection to 90% of $V_{oi}$ )			8	15	ms
$t_{RC}$	RC start-up time (from $V_{RC}$ connection to 90% of $V_{oi}$ )	max $I_O$		2	5	ms
RC	Sink current	See operating information	10			mA
	Trigger level	Decreasing / Increasing RC-voltage		0.8/2.5		V
$I_O$	Output current		0		2	A
$I_{lim}$	Current limit threshold	$V_I = 24$ V, $T_{P1} < \text{max } T_{P1}$		3.25	4	A
$I_{sc}$	Short circuit current	$T_{P1} = 25^{\circ}\text{C}$ , see Note 1		1.02		A
$C_{out}$	Recommended Capacitive Load	$T_{P1} = 25^{\circ}\text{C}$	0		1200	$\mu\text{F}$
$V_{Oac}$	Output ripple & noise	See ripple & noise section, $V_{oi}$ , max $I_O$ , see Note 2		30	60	mVp-p
OVP	Over voltage protection	$T_{P1} = +25^{\circ}\text{C}$ , $V_I = 24$ V, 0-100% of max $I_O$		18		V

Note 1: Output Current (RMS), hiccup mode

Note 2: Measured with 0.1  $\mu\text{F}$  ceramic Cap. and 10  $\mu\text{F}$  tantalum (or EE) Cap. cross to output.

**PKE3000 series DC-DC Converters**  
 Input 9 - 36 V, Output up to 7 A / 30 W

28701- BMR7103000 Rev. L March 2022  
 © Flex

**Typical Characteristics**  
**15 V, 2 A / 30 W**

**PKE3315PI(P)**

**Efficiency**

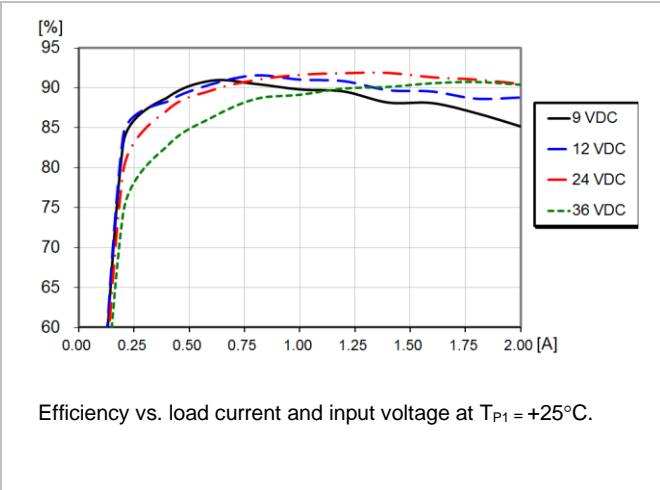

**Power Dissipation**

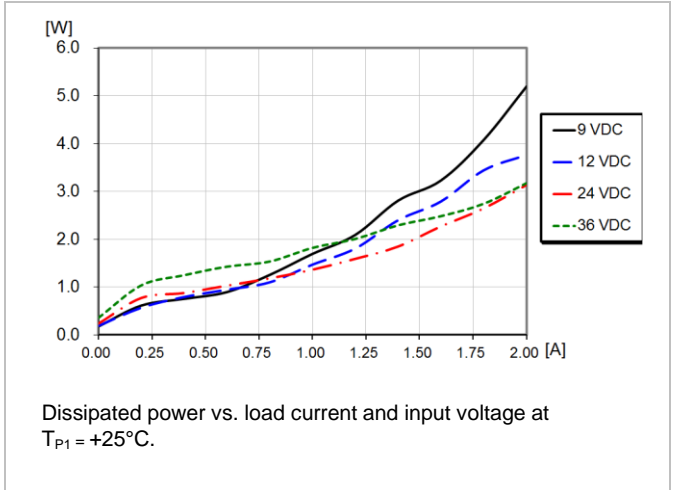

**Output Current Derating**

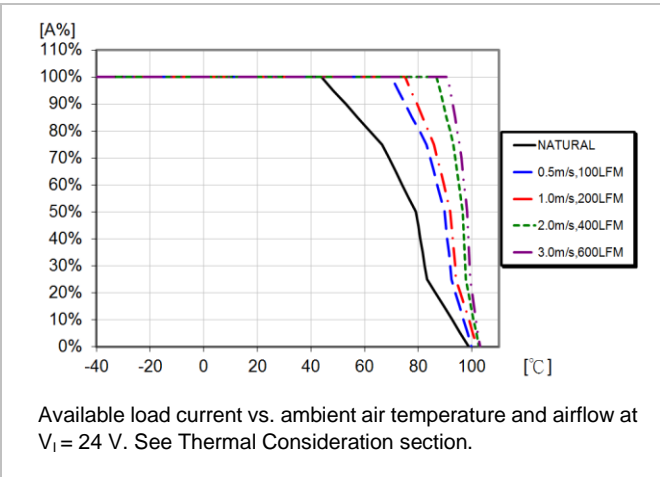

**Current Limit Characteristics**

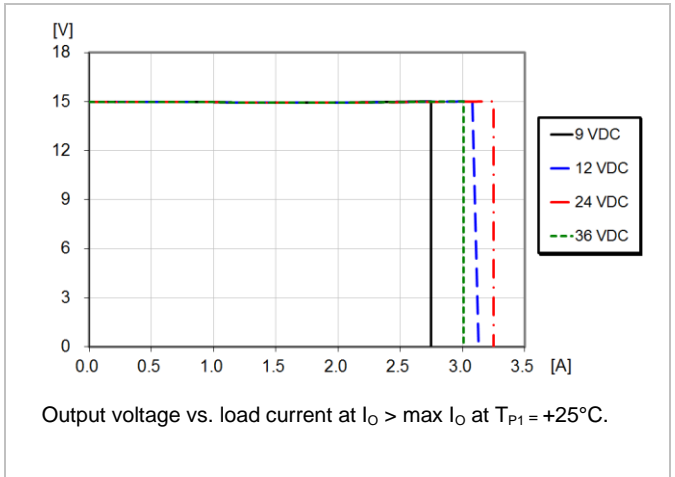

**PKE3000 series DC-DC Converters**  
 Input 9 - 36 V, Output up to 7 A / 30 W

28701- BMR7103000 Rev. L March 2022  
 © Flex

**Typical Characteristics**  
**15 V, 2 A / 30 W**

**PKE3315PI(P)**

**Start-up**

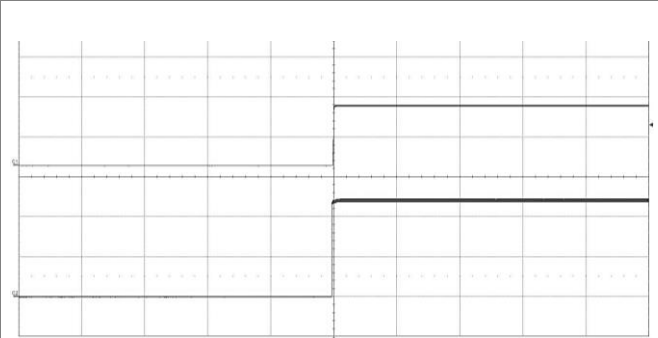

Start-up enabled by connecting  $V_I$  at:  
 $T_{P1} = +25^\circ\text{C}$ ,  $V_I = 24\text{ V}$ ,  
 $I_O = 2\text{ A}$  resistive load.  
 Top trace: output voltage (10 V/div.).  
 Bottom trace: input voltage (10 V/div.).  
 Time scale: (200 ms/div.).

**Shut-down**

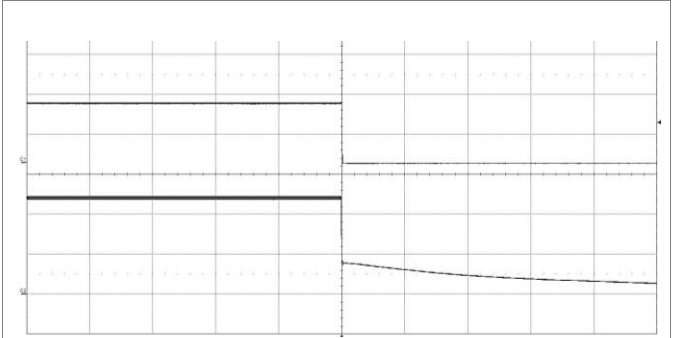

Output disabled by removing  $V_I$  at:  
 $T_{P1} = +25^\circ\text{C}$ ,  $V_I = 24\text{ V}$ ,  
 $I_O = 2\text{ A}$  resistive load.  
 Top trace: output voltage (10 V/div.).  
 Bottom trace: input voltage (10 V/div.).  
 Time scale: (200 ms/div.).

**Output Ripple & Noise**

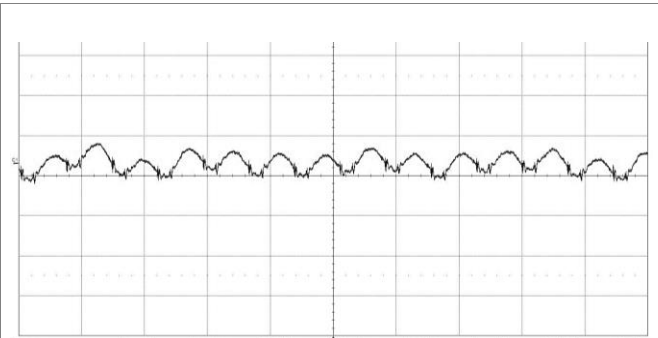

Output voltage ripple at:  
 $T_{P1} = +25^\circ\text{C}$ ,  $V_I = 24\text{ V}$ ,  
 $I_O = 2\text{ A}$  resistive load.  
 Trace: output voltage (20 mV/div.).  
 Time scale: (5 μs/div.).  
 20MHz bandwidth

**Output Load Transient Response**

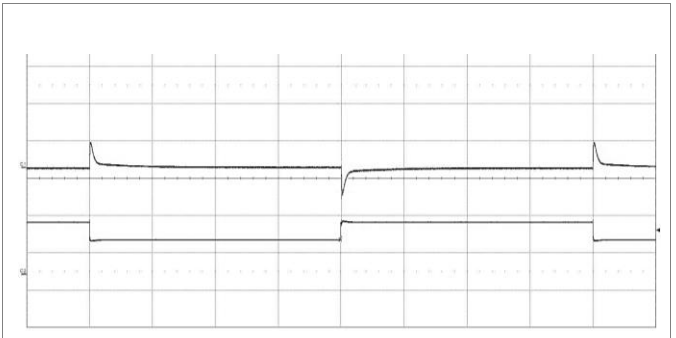

Output voltage response to load current step-change (1.0-1.5-1.0 A) at:  
 $T_{P1} = +25^\circ\text{C}$ ,  $V_I = 24\text{ V}$ .  
 Top trace: output voltage (500 mV/div.).  
 Bottom trace: load current (1 A/div.).  
 Time scale: (2 ms/div.).

**Output Voltage Adjust (TRIM UP/TRIM DOWN)**

**Output Voltage = 15 V**

The resistor value for an adjusted output voltage is calculated by using the following equations:

Output Voltage Adjust, Increase:

$$R_{\text{ADJ\_UP}} = \left( \frac{4.4993}{\Delta} - 30 \right) \text{ k}\Omega$$

Output Voltage Adjust, Decrease:

$$R_{\text{ADJ\_DOWN}} = \left( \frac{4.6}{\Delta} - 39.099 \right) \text{ k}\Omega$$

Example:

To trim up the 15 V model by 8% to 16.2V the required external resistor is:

$$R_{\text{ADJ\_UP}} = \left( \frac{4.4993}{0.08} - 30 \right) = 26.24 \text{ k}\Omega$$

Example:

To trim down the 15 V model by 7% to 13.95V the required external resistor is:

$$R_{\text{ADJ\_DOWN}} = \left( \frac{4.6}{0.07} - 39.099 \right) = 26.62 \text{ k}\Omega$$

## Technical Specification

**PKE3000 series DC-DC Converters**  
Input 9 - 36 V, Output up to 7 A / 30 W

28701- BMR7103000 Rev. L March 2022  
© Flex

**Electrical Specification**  
**24 V, 1.25 A / 30 W**

**PKE3316ZPI(P)**

$T_{P1} = -40$  to  $105^{\circ}\text{C}$ ,  $V_I = 9$  to  $36\text{V}$ , unless otherwise specified under Conditions.

Typical values given at:  $T_{P1} = +25^{\circ}\text{C}$ ,  $V_I = 24\text{V}$ , max  $I_O$ , unless otherwise specified under Conditions.

Additional  $C_{in} = 220\ \mu\text{F}$ ,  $C_{out} = 10\ \mu\text{F}$  ceramic Cap. +  $22\ \mu\text{F}$  E-Cap. See Operating Information section for selection of capacitor types.

Characteristics		Conditions	min	typ	max	Unit
$V_I$	Input voltage range		9		36	V
$V_{loff}$	Turn-off input voltage	Decreasing input voltage	7.0	7.5	8.0	V
$V_{lon}$	Turn-on input voltage	Increasing input voltage	8.0	8.5	9.0	V
$C_I$	Internal input capacitance			33		$\mu\text{F}$
$P_O$	Output power		0		30	W
$\eta$	Efficiency	50% of max $I_O$ , $V_I = 12\text{V}$		89		%
		max $I_O$ , $V_I = 12\text{V}$		89		
		50% of max $I_O$ , $V_I = 24\text{V}$		90		
		max $I_O$ , $V_I = 24\text{V}$		90		
$P_d$	Power Dissipation	max $I_O$		3.4	4	W
$P_{li}$	Input idling power	$I_O = 0\text{A}$ , $V_I = 24\text{V}$		0.2		W
$P_{RC}$	Input standby power	$V_I = 24\text{V}$ (turned off with RC)		0.1		W
$f_s$	Switching frequency	0-100 % of max $I_O$	238	280	322	kHz

$V_{O1}$	Output voltage initial setting and accuracy	$T_{P1} = +25^{\circ}\text{C}$ , $V_I = 24\text{V}$ , $I_O = 1.25\text{A}$	23.76	24	24.24	V
$V_O$	Output adjust range	See operating information	21.6	24	26.4	V
	Output voltage tolerance band	0-100% of max $I_O$	23.4		24.6	V
	Idling voltage	$I_O = 0\text{A}$	23.4		24.6	V
	Line regulation	max $I_O$		20	48	mV
	Load regulation	$V_I = 24\text{V}$ , 25-100% of max $I_O$		20	240	mV
$V_{tr}$	Load transient voltage deviation	$V_I = 24\text{V}$ , Load step 50-75-50% of max $I_O$ , $di/dt = 100\text{mA}/\mu\text{s}$		$\pm 275$	$\pm 500$	mV
$t_{tr}$	Load transient recovery time			250	500	$\mu\text{s}$
$t_r$	Ramp-up time (from 10-90% of $V_{O1}$ )	100% of max $I_O$		5	10	ms
$t_s$	Start-up time (from $V_I$ connection to 90% of $V_{O1}$ )			8	15	ms
$t_{RC}$	RC start-up time (from $V_{RC}$ connection to 90% of $V_{O1}$ )	max $I_O$		2	5	ms
RC	Sink current	See operating information	10			mA
	Trigger level	Decreasing / Increasing RC-voltage		0.8/2.5		V
$I_O$	Output current		0		1.25	A
$I_{lim}$	Current limit threshold	$V_I = 24\text{V}$ , $T_{P1} < \text{max } T_{P1}$		1.875	2.5	A
$I_{sc}$	Short circuit current	$T_{P1} = 25^{\circ}\text{C}$ , see Note 1		0.95		A
$C_{out}$	Recommended Capacitive Load	$T_{P1} = 25^{\circ}\text{C}$ , see Note 2	0		470	$\mu\text{F}$
$V_{Oac}$	Output ripple & noise	See ripple & noise section, $V_{O1}$ , Max $I_O$ , see Note 3		60	120	mVp-p
OVP	Over voltage protection	$T_{P1} = +25^{\circ}\text{C}$ , $V_I = 24\text{V}$ , 0-100% of max $I_O$		30		V

Note 1: Output Current (RMS), hiccup mode

Note 2: Test condition: Electronic Capacitor and full load

Note 3: Measured with  $0.1\ \mu\text{F}$  ceramic Cap. and  $10\ \mu\text{F}$  tantalum (or EE) Cap. cross to output.

**PKE3000 series DC-DC Converters**  
 Input 9 - 36 V, Output up to 7 A / 30 W

28701- BMR7103000 Rev. L March 2022  
 © Flex

**Typical Characteristics**  
**24 V, 1.25 A / 30 W**

**PKE3316ZPI(P)**

**Efficiency**

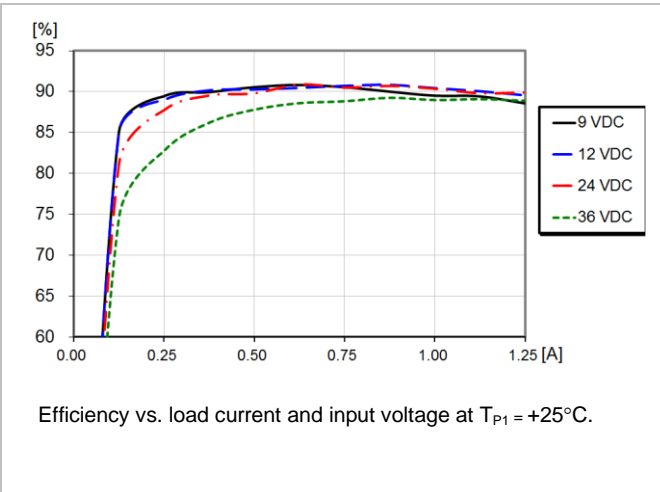

**Power Dissipation**

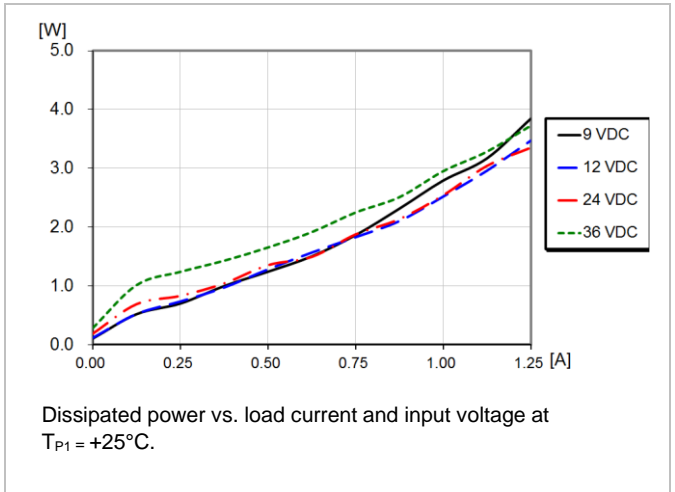

**Output Current Derating**

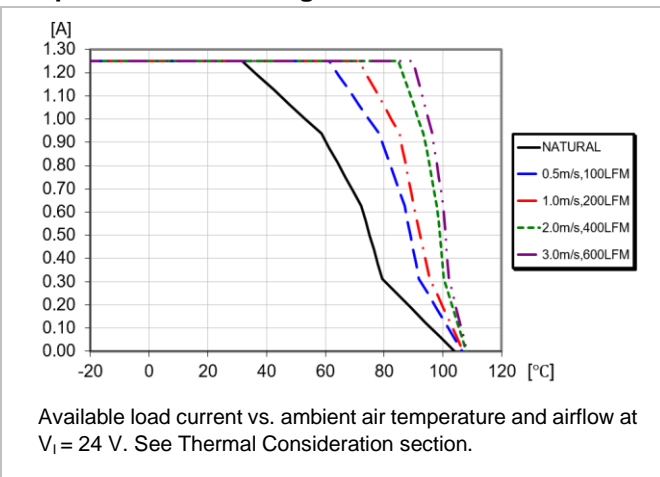

**Current Limit Characteristics**

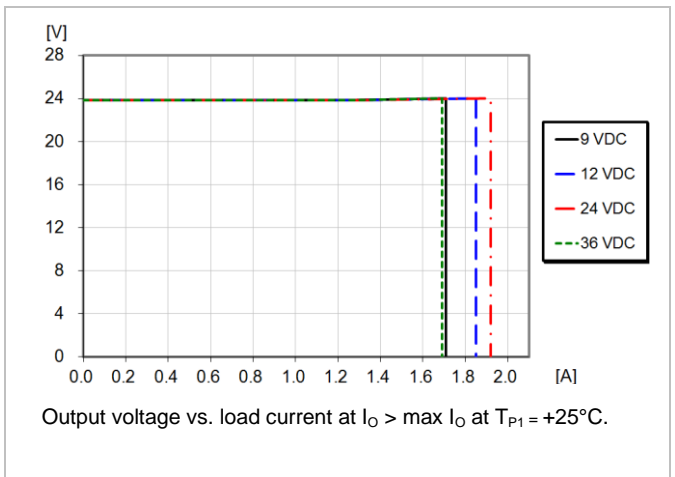

**PKE3000 series DC-DC Converters**  
 Input 9 - 36 V, Output up to 7 A / 30 W

28701- BMR7103000 Rev. L March 2022  
 © Flex

**Typical Characteristics**  
**24 V, 1.25 A / 30 W**

**PKE3316ZPI(P)**

**Start-up**

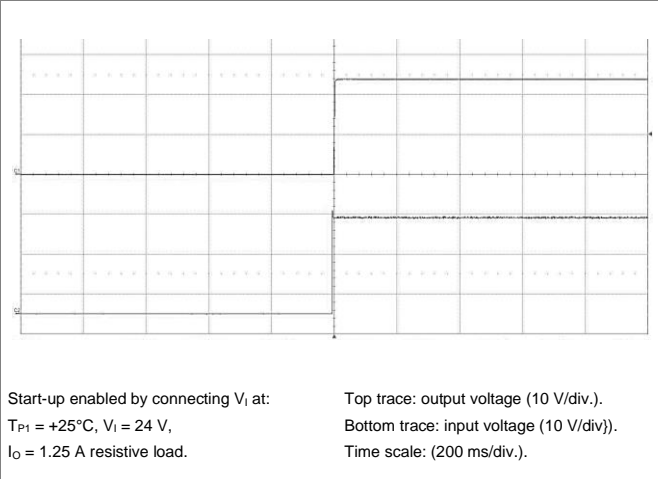

**Shut-down**

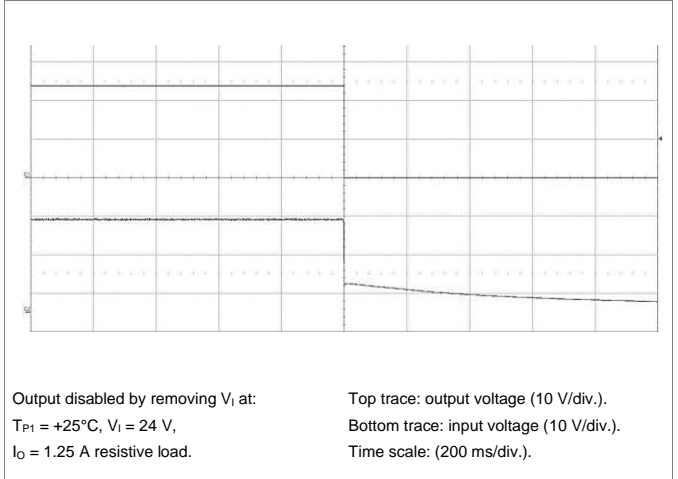

**Output Ripple & Noise**

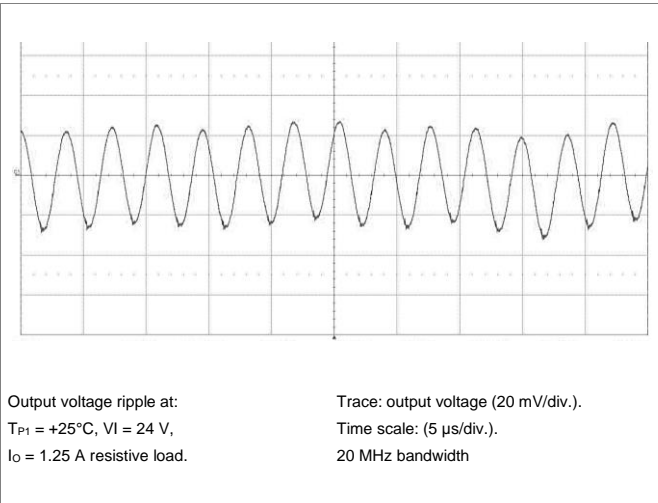

**Output Load Transient Response**

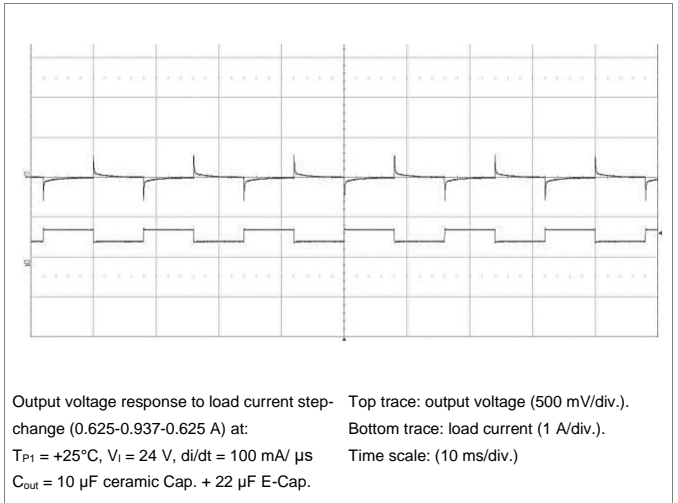

**Output Voltage Adjust (TRIM UP/TRIM DOWN)**

**Output Voltage = 24 V**

The resistor value for an adjusted output voltage is calculated by using the following equations:

Output Voltage Adjust, Increase:

$$R_{ADJ\_UP} = \left( \frac{7.1319}{\Delta} - 56 \right) \text{ k}\Omega$$

Output Voltage Adjust, Decrease:

$$R_{ADJ\_DOWN} = \left( \frac{8.6681}{\Delta} - 71.8 \right) \text{ k}\Omega$$

Example:

To trim up the 24V model by 8% to 25.92V the required external resistor is:

$$R_{ADJ\_UP} = \left( \frac{7.1319}{0.08} - 56 \right) = 33.15 \text{ k}\Omega$$

Example:

To trim down the 24V model by 7% to 22.32V the required external resistor is:

$$R_{ADJ\_DOWN} = \left( \frac{8.6681}{0.07} - 71.8 \right) = 52.03 \text{ k}\Omega$$

## Technical Specification

**PKE3000 series DC-DC Converters**  
Input 9 - 36 V, Output up to 7 A / 30 W

28701- BMR7103000 Rev. L March 2022  
© Flex

**Electrical Specification**  
**48 V, 0.625 A / 30 W**

**PKE3316JPI(P)**

$T_{P1} = -40$  to  $115^{\circ}\text{C}$ ,  $V_I = 9$  to  $36$  V, unless otherwise specified under Conditions.

Typical values given at:  $T_{P1} = +25^{\circ}\text{C}$ ,  $V_I = 24$  V, max  $I_O$ , unless otherwise specified under Conditions.

Additional  $C_{in} = 220$   $\mu\text{F}$ ,  $C_{out} = 0.1$   $\mu\text{F}$  ceramic Cap. +  $10$   $\mu\text{F}$  E-Cap. See Operating Information section for selection of capacitor types.

Characteristics		Conditions	min	typ	max	Unit
$V_I$	Input voltage range		9		36	V
$V_{loff}$	Turn-off input voltage	Decreasing input voltage	7.0	7.5	8.0	V
$V_{lon}$	Turn-on input voltage	Increasing input voltage	8.0	8.5	9.0	V
$C_I$	Internal input capacitance			33		$\mu\text{F}$
$P_O$	Output power		0		30	W
$\eta$	Efficiency	50% of max $I_O$ , $V_I = 12$ V		91		%
		max $I_O$ , $V_I = 12$ V		89		
		50% of max $I_O$ , $V_I = 24$ V		92		
		max $I_O$ , $V_I = 24$ V		90		
$P_d$	Power Dissipation	max $I_O$		3.2	4.5	W
$P_{li}$	Input idling power	$I_O = 0$ A, $V_I = 24$ V		0.2		W
$P_{RC}$	Input standby power	$V_I = 24$ V (turned off with RC)		0.1		W
$f_s$	Switching frequency	0-100 % of max $I_O$	238	280	322	kHz

$V_{oi}$	Output voltage initial setting and accuracy	$T_{P1} = +25^{\circ}\text{C}$ , $V_I = 24$ V, $I_O = 0.625$ A	47.52	48	48.48	V
$V_O$	Output adjust range	See operating information	43.2	48	52.8	V
	Output voltage tolerance band	0-100% of max $I_O$	47.56		49.44	V
	Idling voltage	$I_O = 0$ A	47.56		49.44	V
	Line regulation	max $I_O$		50	96	mV
	Load regulation	$V_I = 24$ V, 0-100% of max $I_O$		250	480	mV
$V_{tr}$	Load transient voltage deviation	$V_I = 24$ V, Load step 50-75-50% of max $I_O$ , $di/dt = 100$ mA/ $\mu\text{s}$		$\pm 275$	$\pm 500$	mV
$t_{tr}$	Load transient recovery time			250	500	$\mu\text{s}$
$t_r$	Ramp-up time (from 10-90% of $V_{oi}$ )	100% of max $I_O$		5	10	ms
$t_s$	Start-up time (from $V_I$ connection to 90% of $V_{oi}$ )			8	15	ms
$t_{RC}$	RC start-up time (from $V_{RC}$ connection to 90% of $V_{oi}$ )	max $I_O$		2	5	ms
RC	Sink current	See operating information	10			mA
	Trigger level	Decreasing / Increasing RC-voltage		0.8/2.5		V
$I_O$	Output current		0		0.625	A
$I_{lim}$	Current limit threshold	$V_I = 24$ V, $T_{P1} < \text{max } T_{P1}$		1.03	1.25	A
$I_{sc}$	Short circuit current	$T_{P1} = 25^{\circ}\text{C}$ , see Note 1		0.48		A
$C_{out}$	Recommended Capacitive Load	$T_{P1} = 25^{\circ}\text{C}$	0		150	$\mu\text{F}$
$V_{Oac}$	Output ripple & noise	See ripple & noise section, $V_{oi}$ , max $I_O$ , see Note 2		80	160	mVp-p
OVP	Over voltage protection	$T_{P1} = +25^{\circ}\text{C}$ , $V_I = 24$ V, 0-100% of max $I_O$		58		V

Note 1: Output Current (RMS), hiccup mode

Note 2: Measured with 0.1 $\mu\text{F}$  ceramic Cap. and 10  $\mu\text{F}$  tantalum (or EE) Cap. cross to output.



**PKE3000 series DC-DC Converters**  
 Input 9 - 36 V, Output up to 7 A / 30 W

28701- BMR7103000 Rev. L March 2022  
 © Flex

**Typical Characteristics**  
**48 V, 0.625 A / 30 W**

**PKE3316JPI(P)**

**Efficiency**

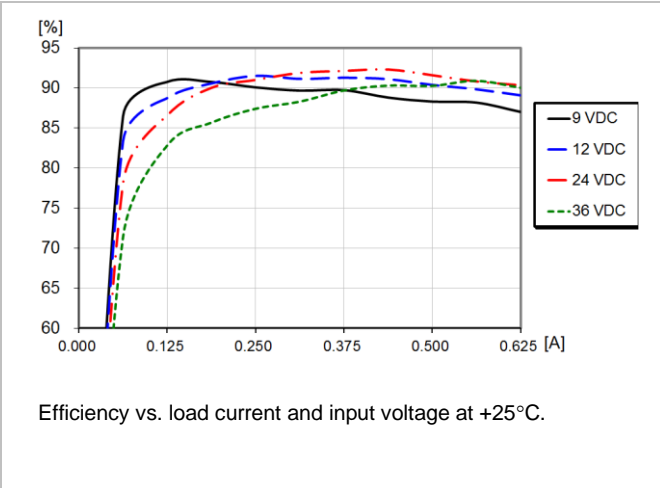

**Power Dissipation**

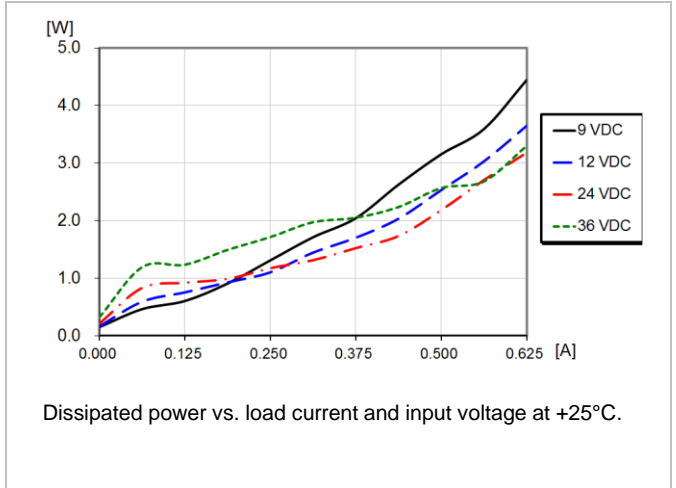

**Output Current Derating**

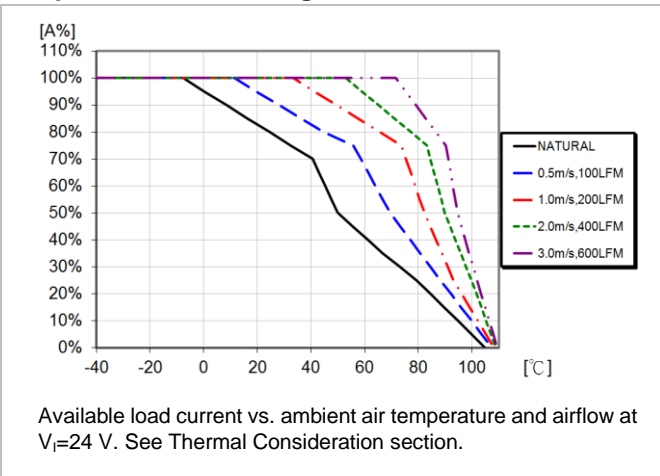

**Current Limit Characteristics**

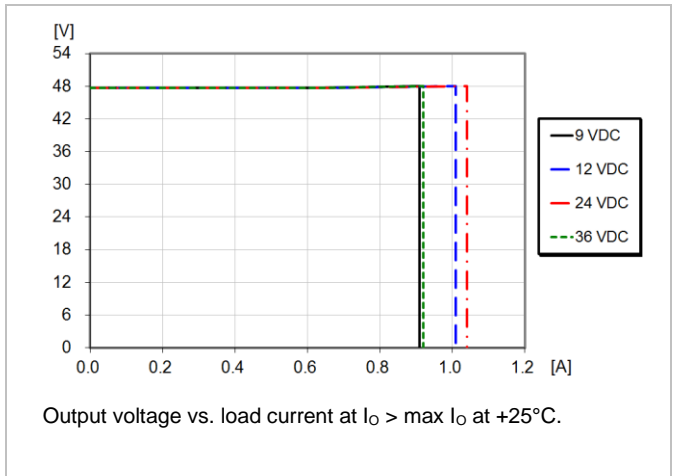

**THERMAL RESISTANCE ( $V_{IN} 24\text{ V}$ )**

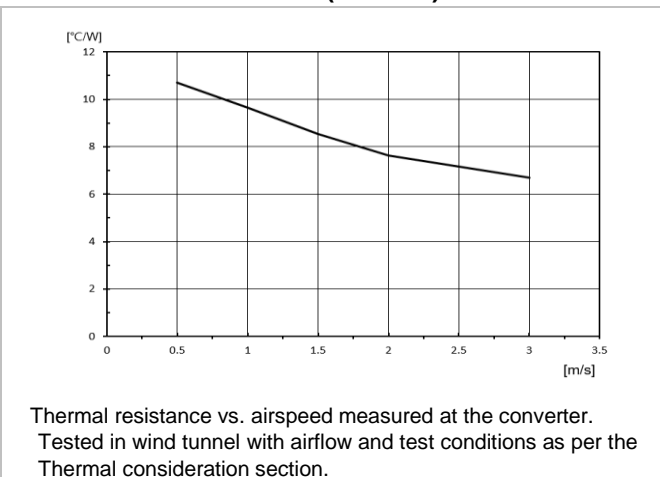

**PKE3000 series DC-DC Converters**  
 Input 9 - 36 V, Output up to 7 A / 30 W

28701- BMR7103000 Rev. L March 2022  
 © Flex

**Typical Characteristics**  
**48 V, 0.625 A / 30 W**

**PKE3316JPI(P)**

**Start-up**

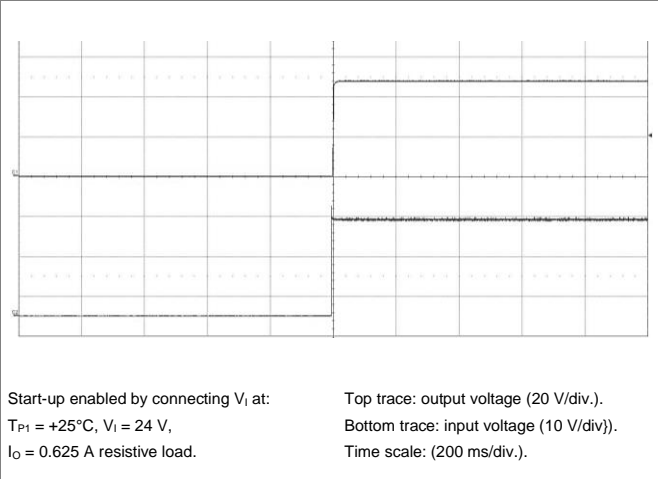

**Shut-down**

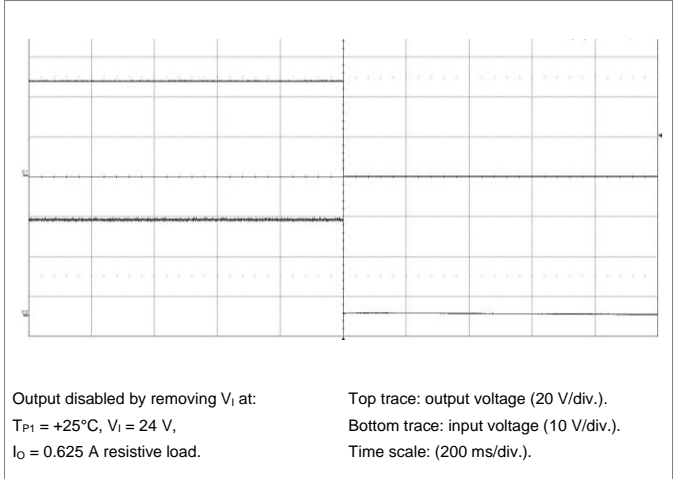

**Output Ripple & Noise**

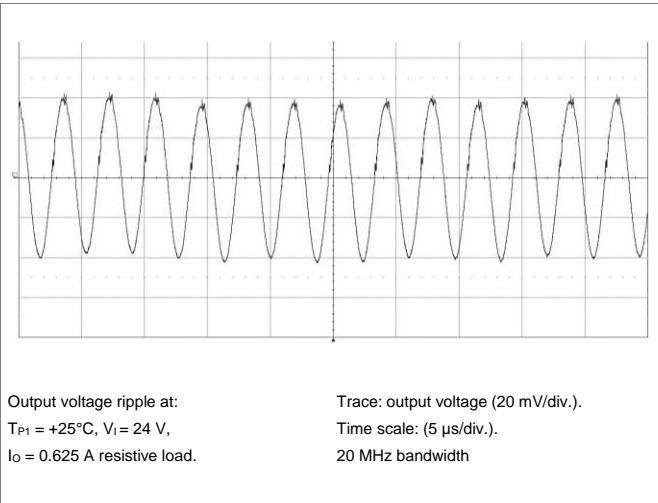

**Output Load Transient Response**

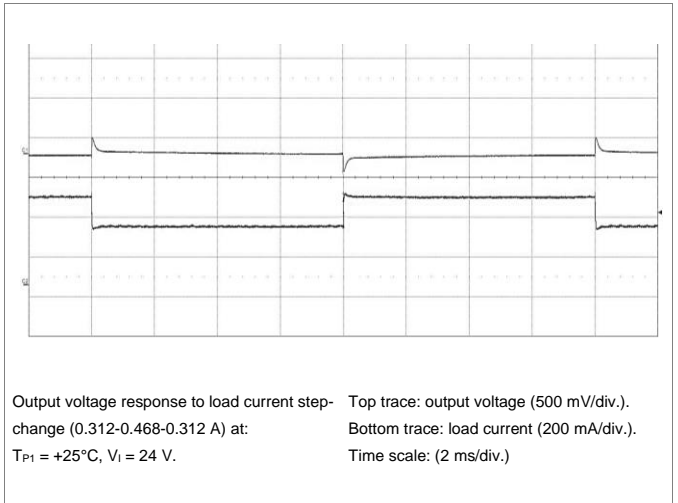

**Output Voltage Adjust (TRIM UP/TRIM DOWN)**

**Output Voltage = 48 V**

The resistor value for an adjusted output voltage is calculated by using the following equations:

Output Voltage Adjust, Increase:

$$R_{\text{ADJ\_UP}} = \left( \frac{14.3215}{\Delta} - 100 \right) \text{ k}\Omega$$

Output Voltage Adjust, Decrease:

$$R_{\text{ADJ\_DOWN}} = \left( \frac{13.8785}{\Delta} - 128.2 \right) \text{ k}\Omega$$

Example:

To trim up the 48 V model by 8% to 51.84V the required external resistor is:

$$R_{\text{ADJ\_UP}} = \left( \frac{14.3215}{0.08} - 100 \right) = 79.02 \text{ k}\Omega$$

Example:

To trim down the 48 V model by 7% to 44.64V the required external resistor is:

$$R_{\text{ADJ\_DOWN}} = \left( \frac{13.8785}{0.07} - 128.2 \right) = 70.06 \text{ k}\Omega$$

## Technical Specification

**PKE3000 series DC-DC Converters**  
Input 9 - 36 V, Output up to 7 A / 30 W

28701- BMR7103000 Rev. L March 2022  
© Flex

**Electrical Specification**  
**54 V, 0.463 A / 25 W**

**PKE3316HPI(P)**

$T_{P1} = -40$  to  $115^{\circ}\text{C}$ ,  $V_I = 9$  to  $36$  V, unless otherwise specified under Conditions.

Typical values given at:  $T_{P1} = +25^{\circ}\text{C}$ ,  $V_I = 24$  V, max  $I_O$ , unless otherwise specified under Conditions.

Additional  $C_{in} = 220$   $\mu\text{F}$ ,  $C_{out} = 0.1$   $\mu\text{F}$  ceramic Cap. +  $10$   $\mu\text{F}$  E-Cap. See Operating Information section for selection of capacitor types.

Characteristics		Conditions	min	typ	max	Unit
$V_I$	Input voltage range		9		36	V
$V_{loff}$	Turn-off input voltage	Decreasing input voltage	7.0	7.5	8.0	V
$V_{lon}$	Turn-on input voltage	Increasing input voltage	8.0	8.5	9.0	V
$C_I$	Internal input capacitance			33		$\mu\text{F}$
$P_O$	Output power		0		30	W
$\eta$	Efficiency	50% of max $I_O$ , $V_I = 12$ V		91		%
		max $I_O$ , $V_I = 12$ V		88		
		50% of max $I_O$ , $V_I = 24$ V		91		
		max $I_O$ , $V_I = 24$ V		90		
$P_d$	Power Dissipation	max $I_O$		3	3.8	W
$P_{li}$	Input idling power	$I_O = 0$ A, $V_I = 24$ V		0.2		W
$P_{RC}$	Input standby power	$V_I = 24$ V (turned off with RC)		0.1		W
$f_s$	Switching frequency	0-100 % of max $I_O$	238	280	322	kHz

$V_{oi}$	Output voltage initial setting and accuracy	$T_{P1} = +25^{\circ}\text{C}$ , $V_I = 24$ V, $I_O = 0.463$ A	53.46	54	54.54	V
$V_O$	Output adjust range	See operating information	48.6	54	59.4	V
	Output voltage tolerance band	0-100% of max $I_O$	52.38		55.62	V
	Idling voltage	$I_O = 0$ A	52.38		55.62	V
	Line regulation	max $I_O$		60	108	mV
	Load regulation	$V_I = 24$ V, 0-100% of max $I_O$		300	540	mV
$V_{tr}$	Load transient voltage deviation	$V_I = 24$ V, Load step 50-75-50% of max $I_O$ , $di/dt = 100$ mA/ $\mu\text{s}$		$\pm 275$	$\pm 500$	mV
$t_{tr}$	Load transient recovery time			250	500	$\mu\text{s}$
$t_r$	Ramp-up time (from 10-90% of $V_{oi}$ )	100% of max $I_O$		5	10	ms
$t_s$	Start-up time (from $V_I$ connection to 90% of $V_{oi}$ )			8	15	ms
$t_{RC}$	RC start-up time (from $V_{RC}$ connection to 90% of $V_{oi}$ )	max $I_O$		2	5	ms
RC	Sink current	See operating information	10			mA
	Trigger level	Decreasing / Increasing RC-voltage		0.8/2.5		V
$I_O$	Output current		0		0.463	A
$I_{lim}$	Current limit threshold	$V_I = 24$ V, $T_{P1} < \text{max } T_{P1}$		0.75	0.926	A
$I_{sc}$	Short circuit current	$T_{P1} = 25^{\circ}\text{C}$ , see Note 1		0.37		A
$C_{out}$	Recommended Capacitive Load	$T_{P1} = 25^{\circ}\text{C}$	0		100	$\mu\text{F}$
$V_{Oac}$	Output ripple & noise	See ripple & noise section, $V_{oi}$ , max $I_O$ , see Note 2		80	160	mVp-p
OVP	Over voltage protection	$T_{P1} = +25^{\circ}\text{C}$ , $V_I = 24$ V, 0-100% of max $I_O$		62		V

Note 1: Output Current (RMS), hiccup mode

Note 2: Measured with 0.1  $\mu\text{F}$  ceramic Cap. and 10  $\mu\text{F}$  tantalum (or EE) Cap. cross to output.

**PKE3000 series DC-DC Converters**  
 Input 9 - 36 V, Output up to 7 A / 30 W

28701- BMR7103000 Rev. L

March 2022

© Flex

**Typical Characteristics**  
**54 V, 0.463 A / 25 W**

**PKE3316HPI(P)**

**Efficiency**

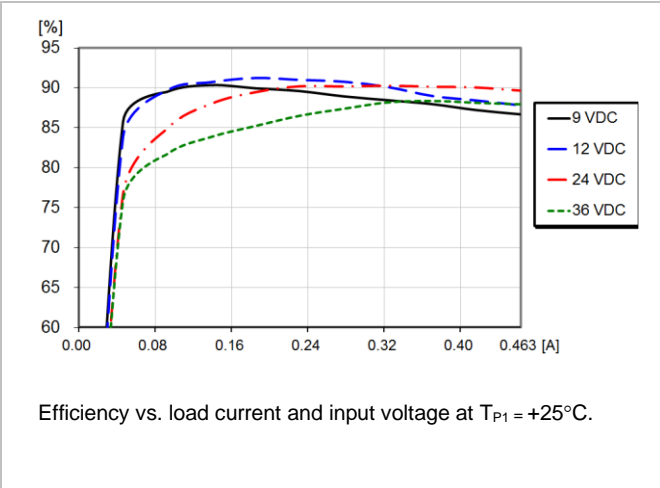

**Power Dissipation**

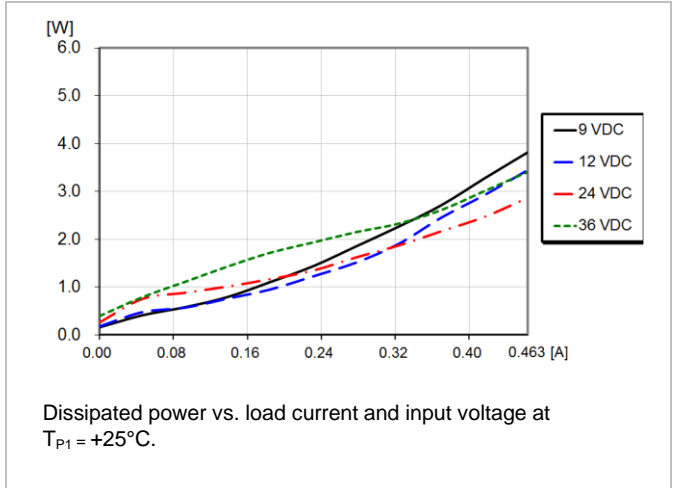

**Output Current Derating**

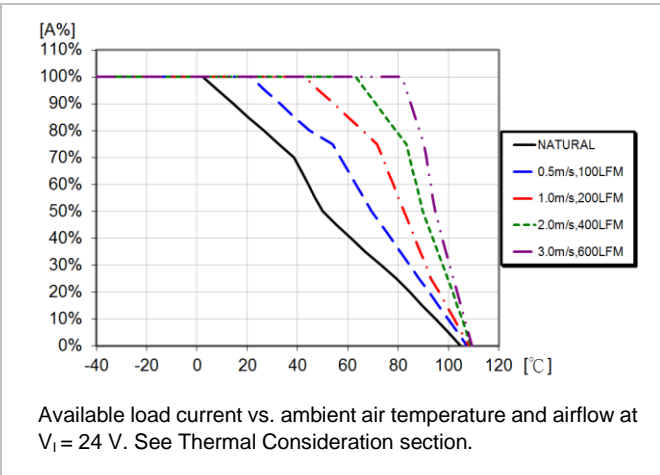

**Current Limit Characteristics**

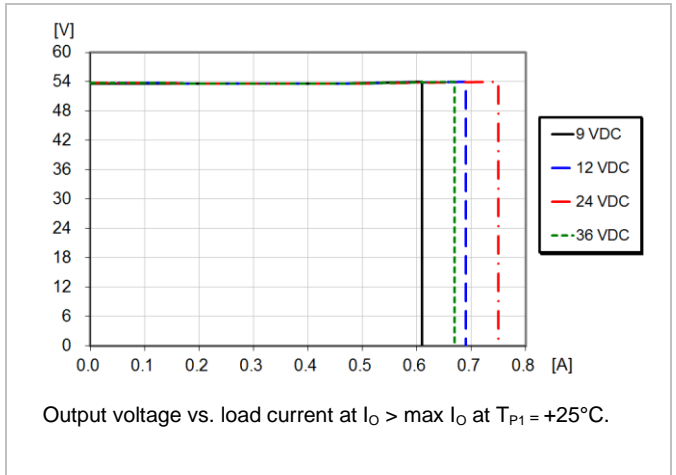

**PKE3000 series DC-DC Converters**  
 Input 9 - 36 V, Output up to 7 A / 30 W

28701- BMR7103000 Rev. L March 2022  
 © Flex

**Typical Characteristics**  
**54 V, 0.463 A / 25 W**

**PKE3316HPI(P)**

**Start-up**

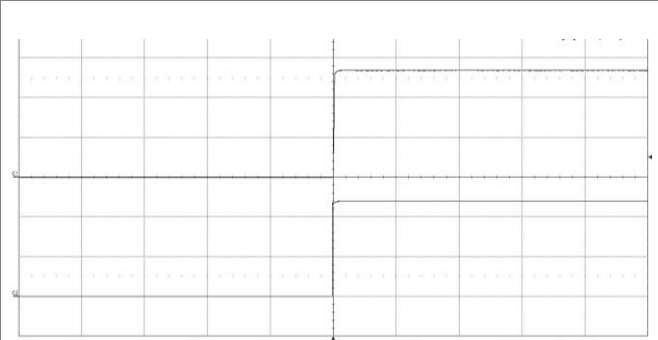

Start-up enabled by connecting  $V_I$  at:  
 $T_{P1} = +25^{\circ}\text{C}$ ,  $V_I = 24\text{ V}$ ,  
 $I_O = 0.463\text{ A}$  resistive load.  
 Top trace: output voltage (20 V/div).  
 Bottom trace: input voltage (10 V/div).  
 Time scale: (200 ms/div.).

**Shut-down**

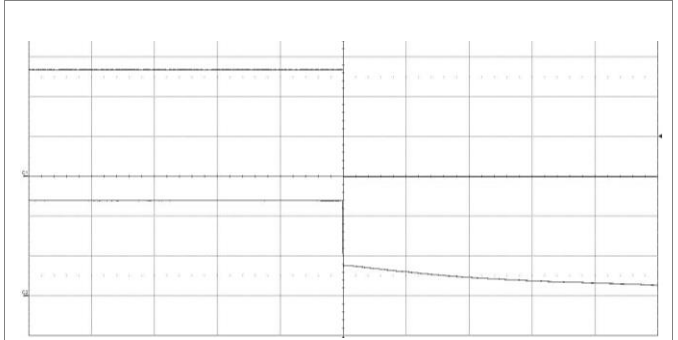

Output disabled by connecting  $V_I$  at:  
 $T_{P1} = +25^{\circ}\text{C}$ ,  $V_I = 24\text{ V}$ ,  
 $I_O = 0.463\text{ A}$  resistive load.  
 Top trace: output voltage (20 V/div.).  
 Bottom trace: input voltage (10 V/div.).  
 Time scale: (200 ms/div.).

**Output Ripple & Noise**

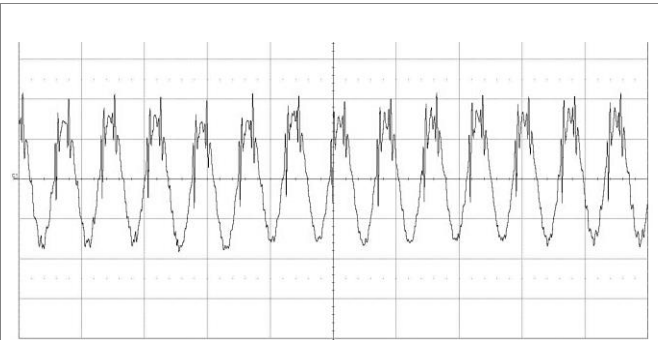

Output voltage ripple at:  
 $T_{P1} = +25^{\circ}\text{C}$ ,  $V_I = 24\text{ V}$ ,  
 $I_O = 0.463\text{ A}$  resistive load.  
 Trace: output voltage (20 mV/div.).  
 Time scale: (5 μs/div.).  
 20 MHz bandwidth

**Output Load Transient Response**

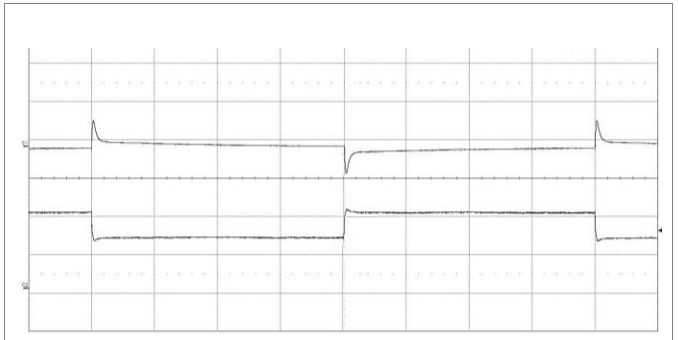

Output voltage response to load current step-change (0.231-0.347-0.231 A) at:  
 $T_{P1} = +25^{\circ}\text{C}$ ,  $V_I = 24\text{ V}$ .  
 Top trace: output voltage (500 mV/div.).  
 Bottom trace: load current (200 mA/div.).  
 Time scale: (2 ms/div.).

**Output Voltage Adjust (TRIM UP/TRIM DOWN)**

**Output Voltage = 54 V**

The resistor value for an adjusted output voltage is calculated by using the following equations:

Output Voltage Adjust, Increase:

$$R_{ADJ\_UP} = \left( \frac{16.2}{\Delta} - 110 \right) \text{ k}\Omega$$

Output Voltage Adjust, Decrease:

$$R_{ADJ\_DOWN} = \left( \frac{16.2}{\Delta} - 142.4 \right) \text{ k}\Omega$$

Example:

To trim up the 54 V model by 8% to 58.32 V the required external resistor is:

$$R_{ADJ\_UP} = \left( \frac{16.2}{0.08} - 110 \right) = 92.5 \text{ k}\Omega$$

Example:

To trim down the 54 V model by 7% to 50.22V the required external resistor is:

$$R_{ADJ\_DOWN} = \left( \frac{16.2}{0.07} - 142.4 \right) = 89.03 \text{ k}\Omega$$

Technical Specification

**PKE3000 series DC-DC Converters**  
 Input 9 - 36 V, Output up to 7 A / 30 W

28701- BMR7103000 Rev. L March 2022  
 © Flex

**EMC Specification**

Conducted EMI measured according to EN55032, CISPR 32 and FCC part 15J (see test set-up). See Design Note 029 for further information.

The fundamental switching frequency is 400 kHz for PKE3211PI at  $V_i = 24\text{ V}$  and max  $I_o$ .

**Conducted EMI Input terminal value (PKE3211PI typ.)**

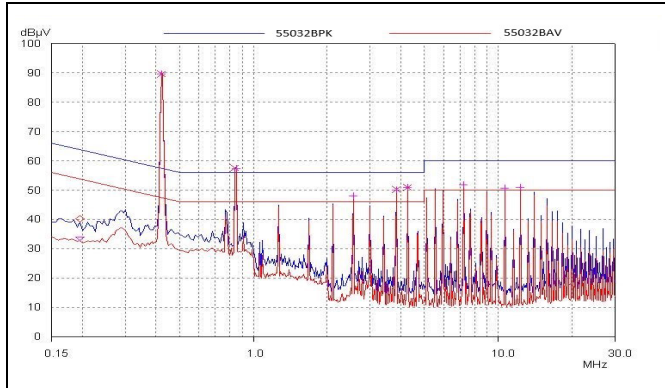

EMI without filter

**Optional external filter for class B**

Suggested external input filter in order to meet class B in EN 55032, CISPR 32 and FCC part 15J.

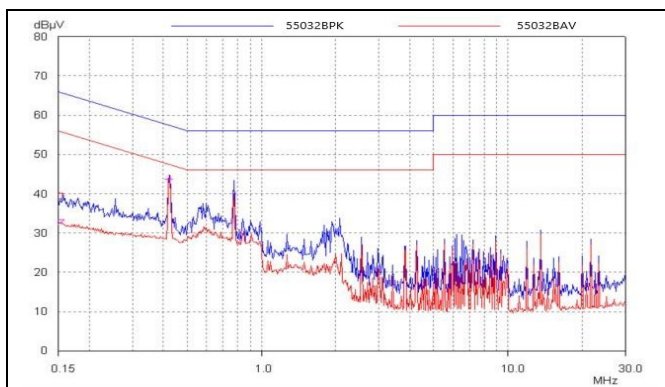
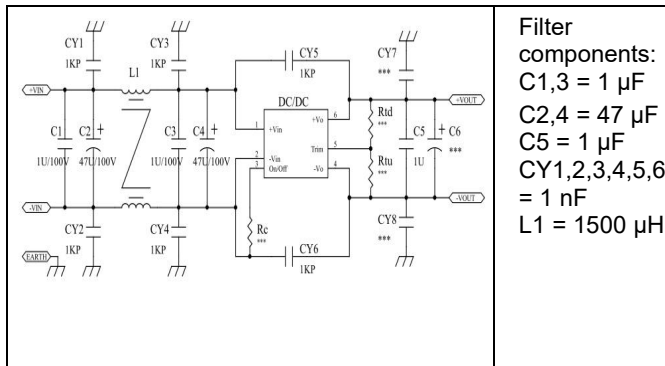

EMI with filter

The fundamental switching frequency is 280 kHz for PKE3316ZPI at  $V_i = 24\text{ V}$  and max  $I_o$ .

**Conducted EMI Input terminal value (PKE3316ZPI typ.)**

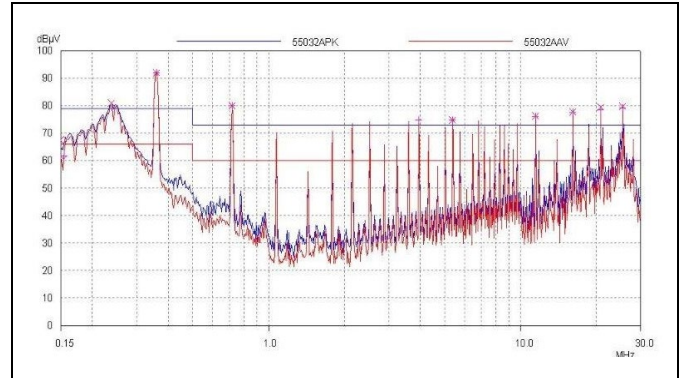

EMI without filter

**Optional external filter for class A**

Suggested external input filter in order to meet class A in EN 55032, CISPR 32 and FCC part 15J.

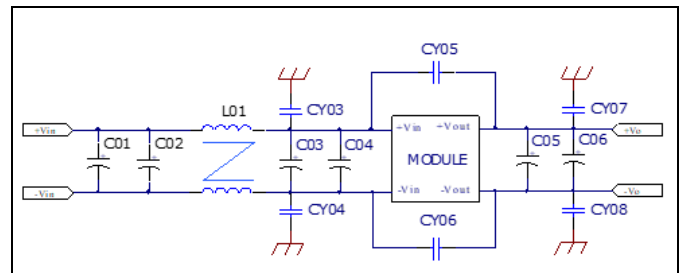

**Filter components:**  
 CY03, CY04: 680 pF (Y CAP.)+ bead core\*2 (RH type)  
 CY05: 2.2 nF (Y CAP.)+ bead core\*2  
 CY07: 100 pF (Y CAP.) + bead core\*2  
 C01, C02, C03, C04, C05, C06: 100 µF (AL-CAP.)  
 L01: 1.6 mH (CM CHOKE)  
 CY04, CY06, CY08 were not assembled in test

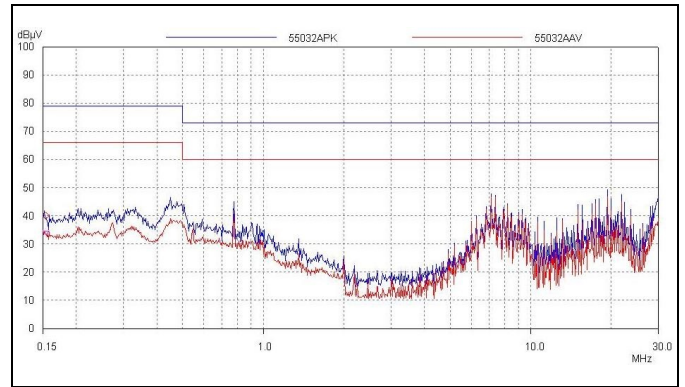

EMI with filter

Technical Specification

**PKE3000 series DC-DC Converters**  
 Input 9 - 36 V, Output up to 7 A / 30 W

28701- BMR7103000 Rev. L March 2022  
 © Flex

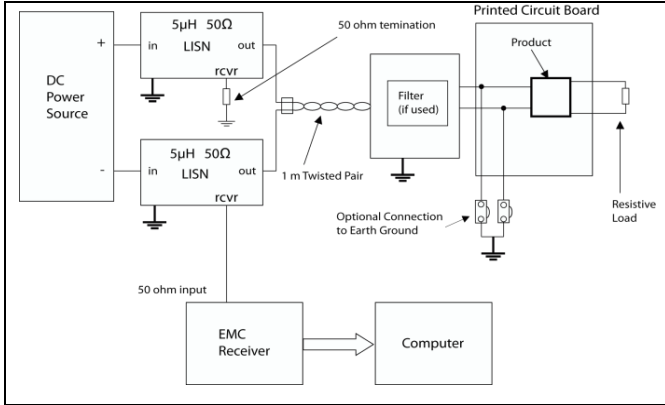

Test set-up

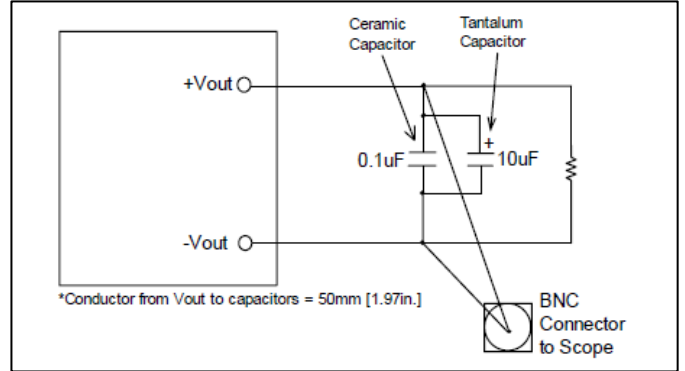

Output ripple and noise test setup for PKE33XXX variant

**Layout recommendations**

The radiated EMI performance of the product will depend on the PWB layout and ground layer design. It is also important to consider the stand-off of the product.

A ground layer will increase the stray capacitance in the PWB and improve the high frequency EMC performance.

**Output ripple and noise**

Output ripple and noise measured according to figure below. See Design Note 022 for detailed information.

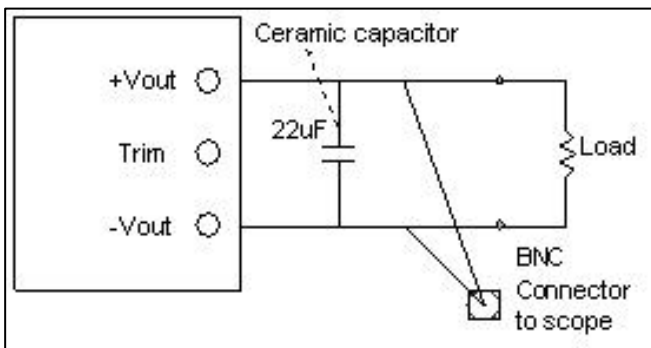

Output ripple and noise test setup for PKE32XX variant



## Technical Specification

**PKE3000 series DC-DC Converters**  
Input 9 - 36 V, Output up to 7 A / 30 W

28701- BMR7103000 Rev. L March 2022

© Flex

## Operating Information

### Input Voltage

The input voltage range is 9 to 36 Vdc.

At input voltages exceeding 36 V, the power loss will be higher than at normal input voltage and  $T_{P1}$  must be limited to absolute max +110°C for PKE32XX variants' products and +115°C for PKE33XXX variants' products. The absolute maximum continuous input voltage is 36 Vdc.

Short duration transient disturbances can occur on the DC distribution and input of the product when a short circuit fault occurs on the equipment side of a protective device (fuse or circuit breaker). The voltage level, duration and energy of the disturbance are dependant on the particular DC distribution network characteristics and can be sufficient to damage the product unless measures are taken to suppress or absorb this energy. The transient voltage can be limited by capacitors and other energy absorbing devices like zener diodes connected across the positive and negative input conductors at a number of strategic points in the distribution network. The end-user must secure that the transient voltage will not exceed the value stated in the Absolute maximum ratings. ETSI TR 100 283 examines the parameters of DC distribution networks and provides guidelines for controlling the transient and reduce its harmful effect.

### Turn-off Input Voltage

The products monitor the input voltage and will turn on and turn off at predetermined levels.

The minimum hysteresis between turn on and turn off input voltage is about 1 V.

### Remote Control (RC)

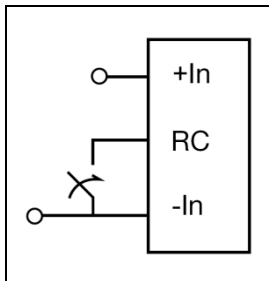

The products are fitted with a remote control function referenced to the primary negative input connection -In, with negative and positive logic options available. The RC function allows the product to be turned on/off by an external device like a semiconductor or mechanical switch. The RC pin has an internal pull up resistor to +In.

The external device must provide a minimum required sink current to guarantee a voltage not higher than maximum voltage on the RC pin (see Electrical characteristics table). When the RC pin is left open, the voltage generated on the RC pin is 3 – 6 V.

The standard product is provided with “negative logic” (Active Low) remote control. When the RC pin is left open, or connected to a voltage higher than 2.5V referenced to -In, the product will be off when the input voltage is applied. To turn on the product the RC pin should be connected to -In. In situations where it is desired to have the product to power up automatically without

the need for control signals or a switch, the RC pin must be wired directly to -In.

The second option is “positive logic” (Active High) remote control, which can be ordered by adding the suffix “P” to the end of the part number. In this case, when the RC pin is left open, the product starts up automatically when the input voltage is applied. Turn off is achieved by connecting the RC pin to the -In. The product will restart automatically when this connection is opened.

See Design Note 021 for detailed information.

### Input and Output Impedance

The impedance of both the input source and the load will interact with the impedance of the product. It is important that the input source has low characteristic impedance. The products are designed for stable operation without external capacitors connected to the input or output. The performance in some applications can be enhanced by addition of external capacitance as described under External Decoupling Capacitors.

If the input voltage source contains significant inductance, the addition of a 22 - 100  $\mu$ F capacitor across the input of the PKE 32XX (15W variant) product or a 220  $\mu$ F capacitor across the input of the PKE 33XXX (30W variant) product will ensure stable operation. The capacitor is not required when powering the product from an input source with an inductance below 10  $\mu$ H. The minimum required capacitance value depends on the output power and the input voltage. The higher output power the higher input capacitance is needed. Approximately doubled capacitance value is required for a 24 V input voltage source compared to a 48 V input voltage source.

### External Decoupling Capacitors

When powering loads with significant dynamic current requirements, the voltage regulation at the point of load can be improved by addition of decoupling capacitors at the load. The most effective technique is to locate low ESR ceramic and electrolytic capacitors as close to the load as possible, using several parallel capacitors to lower the effective ESR. The ceramic capacitors will handle high-frequency dynamic load changes while the electrolytic capacitors are used to handle low frequency dynamic load changes. It is equally important to use low resistance and low inductance PWB layouts and cabling.

External decoupling capacitors will become part of the product's control loop. The control loop is optimized for a wide range of external capacitance and the maximum recommended value that could be used without any additional analysis is found in the Electrical specification. The ESR of the capacitors is a very important parameter. Stable operation is guaranteed with a verified ESR value of  $>5$  m $\Omega$  across the output connections. For further information please contact your local Flex representative.



## Technical Specification

**PKE3000 series DC-DC Converters**  
Input 9 - 36 V, Output up to 7 A / 30 W

28701- BMR7103000 Rev. L March 2022

© Flex

### Output Voltage Adjust

The products have an Output Voltage Adjust pin (Trim). This pin can be used to adjust the output voltage above or below Output voltage initial setting.

When increasing the output voltage, the voltage at the output pins must be kept below the threshold of the over voltage protection, (OVP) to prevent the product from shutting down. At increased output voltages the maximum power rating of the product remains the same, and the max output current must be decreased correspondingly.

To increase the voltage the resistor should be connected between the  $T_{rim}$  pin and  $-O_{ut}$  pin. The resistor value of the Output voltage adjust function is according to information given under the Output section for the respective product. To decrease the output voltage, the resistor should be connected between the  $T_{rim}$  pin and  $+O_{ut}$  pin.

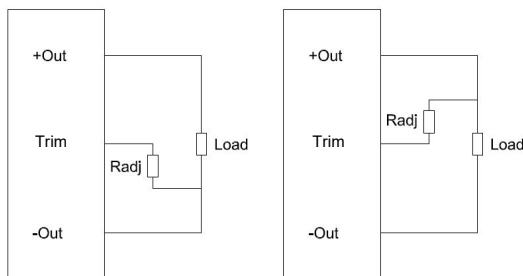

Increase

Decrease

### Over Temperature Protection (OTP)

The products are protected from thermal overload by an internal over temperature shutdown circuit. When  $T_{P1}$  as defined in thermal consideration section exceeds  $115^{\circ}\text{C}$  the product will shut down. The product will make continuous attempts to start up (non-latching mode) and resume normal operation automatically when the temperature has dropped  $>5^{\circ}\text{C}$  below the temperature threshold.

### Over Voltage Protection (OVP)

The converters have output over voltage protection that will prevent output voltage to exceed the specified value in technical specification.

The converter will limit the output voltage to the maximum level. Converters will resume normal operation automatically after removal of the over voltage condition.

### Over Current Protection (OCP)

The products include current limiting circuitry for protection at continuous overload. The output voltage will decrease towards zero for output currents in excess of max output current ( $\text{max } I_o$ ). The product will resume normal operation after removal of the overload. The load distribution should be designed for the maximum output short circuit current specified.

### Thermal Consideration

#### General

The products are designed to operate in different thermal environments and sufficient cooling must be provided to ensure reliable operation.

For products mounted on a PWB without a heat sink attached, cooling is achieved mainly by conduction, from the pins to the host board, and convection, which is dependant on the airflow across the product. Increased airflow enhances the cooling of the product. The Output Current Derating graph found in the Output section for each model provides the available output current vs. ambient air temperature and air velocity at  $V_i = 24 \text{ V}$ .

The product is tested on a  $107 \times 45 \text{ mm}$ ,  $70 \mu\text{m}$  (2 oz), 1-layer test board in a wind box with  $370 \times 220 \text{ mm}$ .

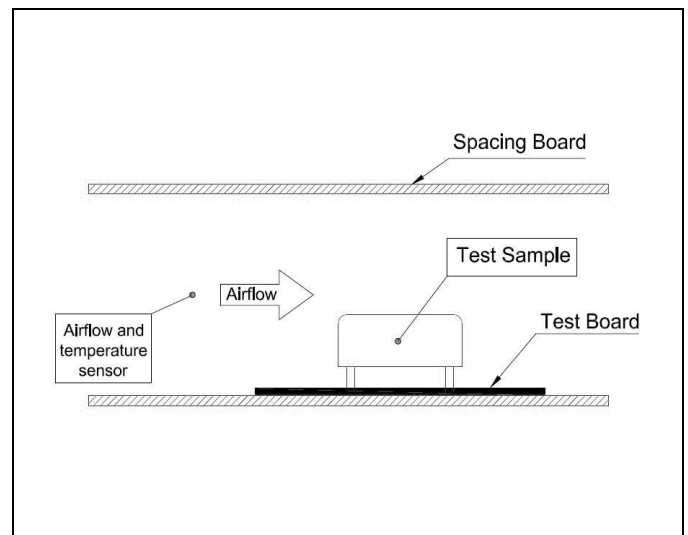

## Technical Specification

<b>PKE3000 series DC-DC Converters</b> Input 9 - 36 V, Output up to 7 A / 30 W	28701- BMR7103000 Rev. L	March 2022
	© Flex	

**Ambient Temperature Calculation**

For products with base plate/heatsink the maximum allowed ambient temperature can be calculated

By using the thermal resistance.

1. The power loss is calculated by using the formula

$$[(1/\eta) - 1] \times \text{output power} - \text{power losses (Pd)}$$

$\eta$  = efficiency of product. E.g. 89.9% = 0.899

2. Find the thermal resistance (Rth) in the Thermal Resistance graph found in the Output section for each model Calculate the temperature increase (AT).  $AT = Rth \times Pd$

3. Max allowed ambient temperature is.  
Max TP1 - AT.

E.g. PKE3316JPI at 2m/s: (Room temperature:25°C)

$$\eta = 0.879 \quad Rth = 7.64^\circ\text{C/W}$$

1.  $[(1/0.879) - 1] \times 30 \text{ W} = 4.12 \text{ W}$

2.  $4.12 \text{ W} \times 7.64^\circ\text{C/W} = 31.4^\circ\text{C}$

3.  $105^\circ\text{C} - 31.4^\circ\text{C} = \text{max ambient temperature is } 73.6^\circ\text{C}$

The actual temperature will be dependent on several factors such as the PB size,number of layers and direction of airflow.

Technical Specification

**PKE3000 series DC-DC Converters**  
 Input 9 - 36 V, Output up to 7 A / 30 W

28701- BMR7103000 Rev. L March 2022  
 © Flex

**Definition of product operating temperature**

The product operating temperatures is used to monitor the temperature of the product, and proper thermal conditions can be verified by measuring the temperature at positions P1. The temperature at this position ( $T_{P1}$ ) should not exceed the maximum temperatures in the table below. Temperature above maximum  $T_{P1}$ , measured at the reference point P1 are not allowed and may cause permanent damage.

Position	Description	Max Temp.
P1	Reference point (PKE32XX variant)	$T_{P1}=110^{\circ}\text{C}$

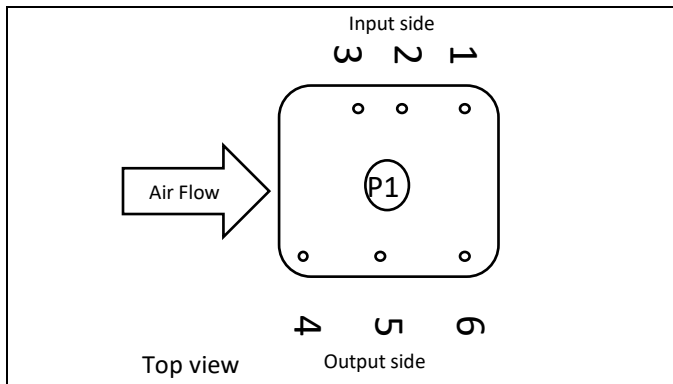

Reference point on PKE32XX variant

Position	Description	Max Temp.
P1	Reference point (PKE33XXX variant)	$T_{P1} = 115^{\circ}\text{C}$

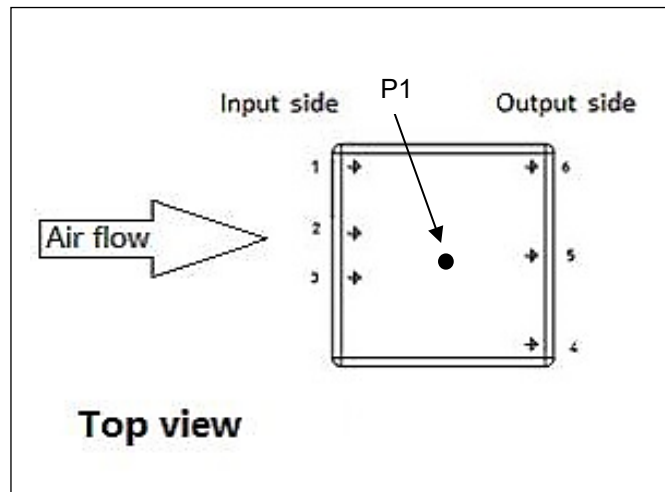

Reference point on PKE33XXX variant

**Connections**

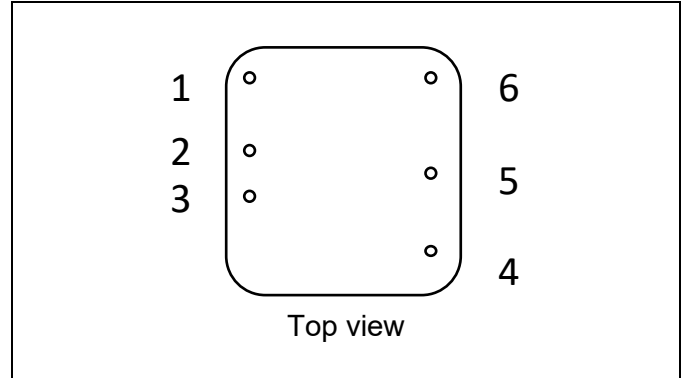

Pin	Designation	Function
1	On/Off Control	Remote control
2	-Input	Negative input
3	+Input	Positive input
4	+Out	Positive output
5	Trim	Output voltage adjust
6	-Out	Negative output

Technical Specification

**PKE3000 series** DC-DC Converters  
 Input 9 - 36 V, Output up to 7 A / 30 W

28701- BMR7103000 Rev. L

March 2022

© Flex

**Mechanical Information**

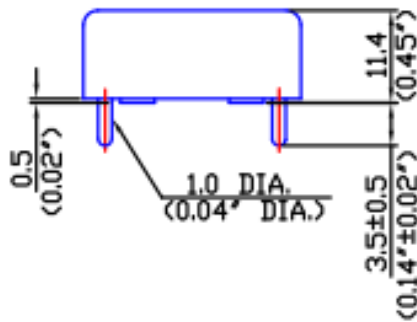
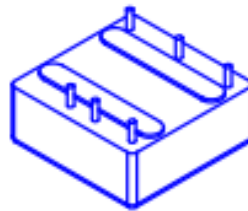
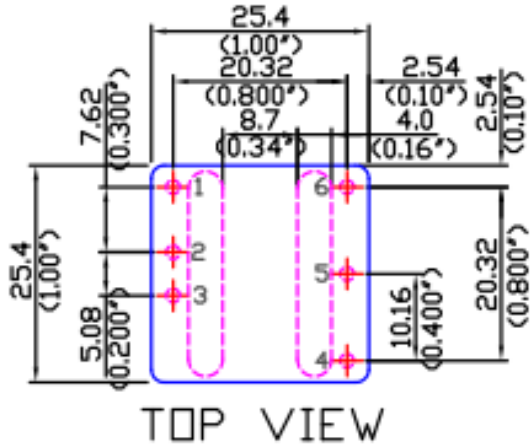

RECOMMENDED FOOTPRINT  
 TOP VIEW

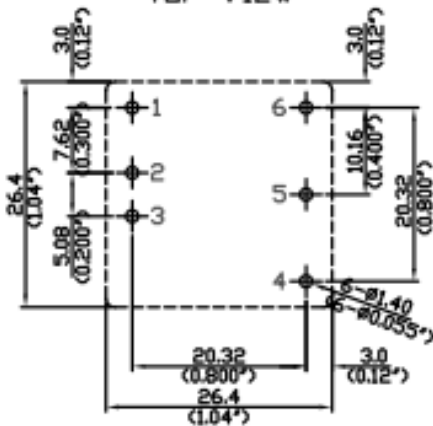

Notes:

1.Pins:  
 Material:Brass  
 Plating: Tin over Nickel

2.Case:  
 Material:Copper  
 Plating: Spray painting

Notes:

1. Weight: typical 16g
2. All dimensions in mm (inches)
3. Tolerance x.x mm = ±1.016mm(0.04 inches)  
 x.xx mm = ±0.254mm(0.010 inches)

Technical Specification

**PKE3000 series DC-DC Converters**  
 Input 9 - 36 V, Output up to 7 A / 30 W

28701- BMR7103000 Rev. L

March 2022

© Flex

**Soldering Information - Hole Mounting**

The hole mounted product is intended for plated through hole mounting by wave or manual soldering. The pin temperature is specified to maximum to 270°C for maximum 10 seconds.

A maximum preheat rate of 4°C/s and maximum preheat temperature of 150°C is suggested. When soldering by hand, care should be taken to avoid direct contact between the hot soldering iron tip and the pins for more than a few seconds in order to prevent overheating.

A no-clean flux is recommended to avoid entrapment of cleaning fluids in cavities inside the product or between the product and the host board. The cleaning residues may affect long time reliability and isolation voltage.

**Delivery Package Information**

The products are delivered in antistatic clamshell trays

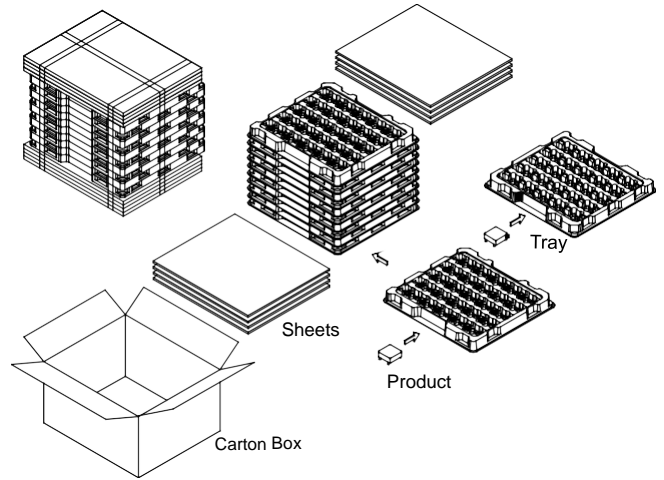

Tray Specifications

<b>Material</b>	Antistatic PS
<b>Surface resistance</b>	$10^5 < \text{Ohm/square} < 10^{11}$
<b>Bakability</b>	This tray is not bake-able
<b>Tray thickness</b>	23.1 mm [0.9094 inch]
<b>Box capacity</b>	250 products (10 full trays/box)
<b>Tray weight</b>	60 g empty, 510 g full tray

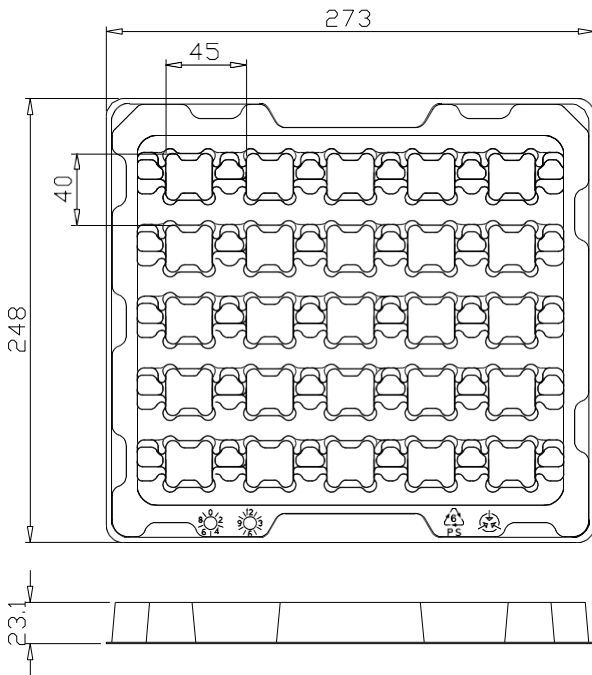

## Technical Specification

<b>PKE3000 series DC-DC Converters</b> Input 9 - 36 V, Output up to 7 A / 30 W	28701- BMR7103000 Rev. L	March 2022
	© Flex	

## Product Qualification Specification

Characteristics			
External visual inspection	IPC-E-610		
Change of temperature (Temperature cycling)	IEC 60068-2-14 Na	Temperature range Number of cycles Dwell/transfer time	-55 to 105°C 20 30 min/3 min
Cold (in operation)	IEC 60068-2-1	Temperature T <sub>A</sub> Duration	-45°C 72 h
Damp heat	IEC 60068-2-30	Temperature Humidity Duration	45°C 95 % RH 72 hours
Electrostatic discharge susceptibility	IEC 61340-3-1, JESD 22-A114	Human body model (HBM)	Class 2, 2000 V
Mechanical shock	IEC 60068-2-27 Ea	Peak acceleration Duration	200 g 6 ms
Operational life test	MIL-STD-202G, method 108A	Duration	1000 h
Resistance to soldering heat	IEC 60068-2-20 Tb, method 1A	Solder temperature Duration	270°C 10-13 s
Robustness of terminations	IEC 60068-2-21 Test Ua1	Through hole mount products	All leads
Solderability	IEC 60068-2-20 test Ta	Temperature, SnPb Eutectic Temperature, Pb-free	235°C 245°C
Vibration, broad band random	IEC 61373	Frequency RMS acceleration Duration	5 to 150 Hz 5 grms 5 hrs in each direction