



DESCRIPTION

MAX487ESA is an RS-485/RS-422 transceiver powered by +5.0V and equipped with $\pm 16\text{kV}$ ESD protection. The entire series has a hot swappable function, which can eliminate transient fault signals on the bus when powered on or hot plugged in.

The MAX487ESA has a low swing rate driver that can reduce EMI and reflections caused by improper terminal matching cables, achieving error free data transmission of up to 500kbps. MAX487ESA is used for half duplex communication.

The receiver of MAX487ESA has 1/8 unit load input impedance and can be connected to up to 256 transceivers on the bus.

MAX487ESA adopts 8-pin DIP and 8-pin SOP packaging.

ABSOLUTE MAXIMUM RATINGS

Supply Voltage (V_{CC}) 6V

Control Input Voltage -0.3V to 6V

Driver Input Voltage (DI) -0.3V to 6V

Driver Output Voltage (A, B) -7V to +12V

Receiver Input Voltage (A, B) -7V to +12V

Receiver Output Voltage (RO) -0.3V to ($V_{CC} + 0.3\text{V}$)

Continuous Power Dissipation ($T_A = +70^\circ\text{C}$)

8-Pin SO (derate 5.88mW/ $^\circ\text{C}$ above $+70^\circ\text{C}$)
500mW

Operating Temperature Ranges 0°C to $+70^\circ\text{C}$

Storage Temperature Range -65°C to $+150^\circ\text{C}$

Lead Temperature (soldering, 10sec) $+300^\circ\text{C}$

PIN CONFIGURATION

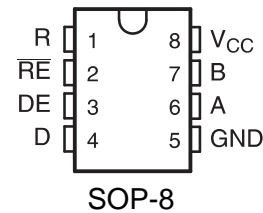

FEATURES

- Low power shutdown mode
- DE and $\overline{\text{RE}}$ adopt a hot swappable input structure
- Up to 256 transceivers with swing are allowed to be mounted on the bus
- Rate limiting function helps achieve error free data transmission
- I/O port adopts enhanced ESD protection ($\pm 16\text{kV}$ IEC 61000-4-2 model)

APPLICATIONS

- RS-422/RS-485 communication
- Digital electricity and water meters, industrial control
- Industrial embedded computers and peripherals, security monitoring systems
- Routers and switches, instruments and meters, level conversion
- EMI sensitive transceiver applications



DCELECTRICAL CHARACTERISTICS

($V_{CC} = 5V \pm 0.25$, $T_A = T_{MIN}$ to T_{MAX} , unless otherwise noted, $T_A = 25^\circ C$)

PARAMETER	SYMBOL	CONDITIONS	MIN	TYP	MAX	UNITS
No-Load Supply Current	I_{CC}	$\overline{RE} = 0V$ or V_{CC}		530		μA
		DE = V_{CC}				
		DE = 0V		475		
Supply Current in Shutdown	I_{SHDN}	DE = 0V, $\overline{RE} = V_{CC}$		0.5	10	μA
Driver Short-Circuit Current, $V_O = High$	I_{OSD1}	$-7V \leq V_O \leq 12V$			250	mA
Driver Short-Circuit Current, $V_O = Low$	I_{OSD2}	$-7V \leq V_O \leq 12V$	-250			mA
Receiver Short-Circuit Current	I_{OSR}	$0V \leq V_O \leq V_{CC}$	7		95	mA
ESD Protection		A, B, Y and Z pins, tested using Human Body Model		± 16		kV
Driver Input to Output	t_{PLH}	$R_{DIFF} = 54\Omega$, $C_{L1} = C_{L2} = 50pF$			1000	ns
	t_{PHL}				1000	
Driver Output Skew to Output	t_{SKEW}	$R_{DIFF} = 54\Omega$, $C_{L1} = C_{L2} = 50pF$			± 140	ns
Driver Rise or Fall Time	t_R , t_F	$R_{DIFF} = 54\Omega$, $C_{L1} = C_{L2} = 100pF$			900	ns
Driver Enable to Output High	t_{ZH}	$C_L = 100pF$, S3 closed			2500	ns
Driver Enable to Output Low	t_{ZL}	$C_L = 100pF$, S2 closed			2500	ns
Driver Disable Time from Low	t_{LZ}	$C_L = 15pF$, S2 closed			100	ns
Driver Disable Time from High	t_{HZ}	$C_L = 15pF$, S3 closed			100	ns
Receiver Input to Output	t_{PLH} , t_{PHL}	$R_{DIFF} = 54\Omega$, $C_{L1} = C_{L2} = 100pF$	20	60	200	ns
$ t_{PLH} - t_{PHL} $ Differential Receiver Skew	t_{SKD}	$R_{DIFF} = 54\Omega$, $C_{L1} = C_{L2} = 100pF$			± 30	ns
Receiver Enable to Output Low	t_{ZL}	$C_{RL} = 15pF$, S1 closed		20	50	ns
Receiver Enable to Output High	t_{ZH}	$C_{RL} = 15pF$, S2 closed		20	50	ns
Receiver Disable Time from Low	t_{LZ}	$C_{RL} = 15pF$, S1 closed		20	50	ns
Receiver Disable Time from High	t_{HZ}	$C_{RL} = 15pF$, S2 closed		20	50	ns
Maximum Data Rate	f_{MAX}			500		kbps
Time to Shutdown	t_{SHDN}	MAX481E (Note 5)	50		700	ns
Receiver Enable from Shutdown to Output High	$t_{ZH(SHDN)}$	$C_L = 15pF$, S2 closed			5500	ns
Receiver Enable from Shutdown to Output Low	$t_{ZL(SHDN)}$	$C_L = 15pF$, S1 closed			5500	ns



SWITCHING CHARACTERISTICS

(V_{CC} = 5.0V ±5%, T_A = 25°C)

PARAMETER	SYMBOL	CONDITIONS	MIN	TYP	MAX	UNITS
Driver Input to Output	t _{PLH}	R _{DIFF} = 54Ω, C _{L1} = C _{L2} = 50pF			1000	ns
	t _{PHL}				1000	
Driver Output Skew to Output	t _{SKEW}	R _{DIFF} = 54Ω, C _{L1} = C _{L2} = 50pF			±140	ns
Driver Rise or Fall Time	t _R , t _F	R _{DIFF} = 54Ω, C _{L1} = C _{L2} = 100pF			900	ns
Driver Enable to Output High	t _{ZH}	C _L = 100pF, S3 closed			2500	ns
Driver Enable to Output Low	t _{ZL}	C _L = 100pF, S2 closed			2500	ns
Driver Disable Time from Low	t _{LZ}	C _L = 15pF, S2 closed			100	ns
Driver Disable Time from High	t _{HZ}	C _L = 15pF, S3 closed			100	ns
Receiver Input to Output	t _{PLH} , t _{PHL}	R _{DIFF} = 54Ω, C _{L1} = C _{L2} = 100pF	20	60	200	ns
t _{PLH} - t _{PHL} Differential Receiver Skew	t _{SKD}	R _{DIFF} = 54Ω, C _{L1} = C _{L2} = 100pF			±30	ns
Receiver Enable to Output Low	t _{ZL}	C _R L = 15pF, S1 closed		20	50	ns
Receiver Enable to Output High	t _{ZH}	C _R L = 15pF, S2 closed		20	50	ns
Receiver Disable Time from Low	t _{LZ}	C _R L = 15pF, S1 closed		20	50	ns
Receiver Disable Time from High	t _{HZ}	C _R L = 15pF, S2 closed		20	50	ns
Maximum Data Rate	f _{MAX}			500		kbps
Time to Shutdown	t _{SHDN}	MAX481E (Note 5)	50		700	ns
Receiver Enable from Shutdown to Output High	t _{ZH} (SHDN)	C _L = 15pF, S2 closed			5500	ns
Receiver Enable from Shutdown to Output Low	t _{ZL} (SHDN)	C _L = 15pF, S1 closed			5500	ns

TABLE OF OPERATION

Transmission					Receipt			
Inputs			Outputs X		Inputs			Outputs
RE	DE	DI	A	B	RE	DE	A-B	RO
X	1	1	1	0	0	X	+0.2V	1
X	1	0	0	1	0	X	-0.2V	0
0	0	X	Z	Z	0	1	Inputs open	1
1	0	X	Z	Z	1	0	X	Z

X-Any level

Z-High resistance



TYPICAL CHARACTERISTICS

OUTPUT CURRENT vs.
RECEIVER OUTPUT LOW VOLTAGE

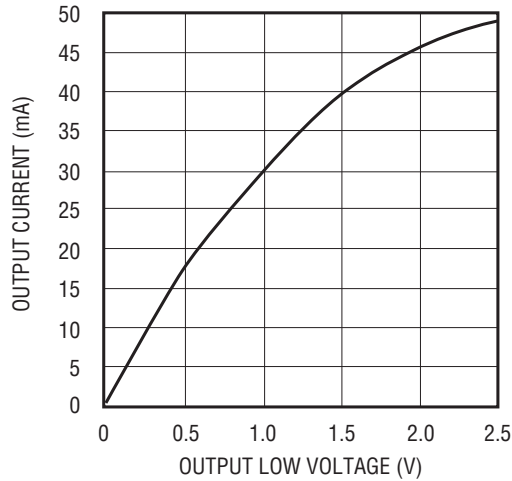

OUTPUT CURRENT vs.
RECEIVER OUTPUT HIGH VOLTAGE

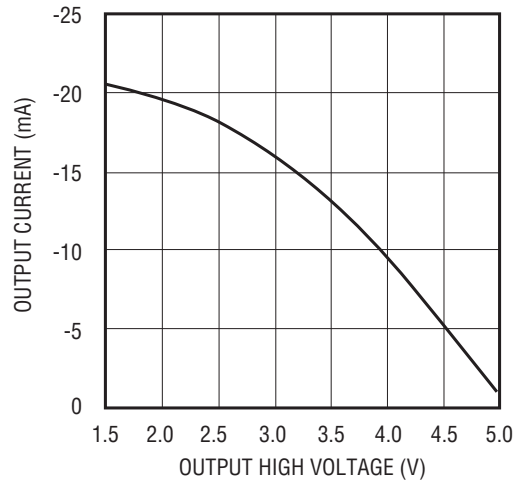

RECEIVER OUTPUT LOW VOLTAGE
vs. TEMPERATURE

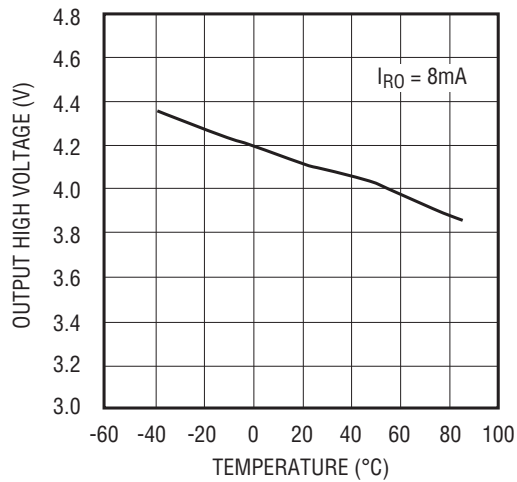

RECEIVER OUTPUT LOW VOLTAGE
vs. TEMPERATURE

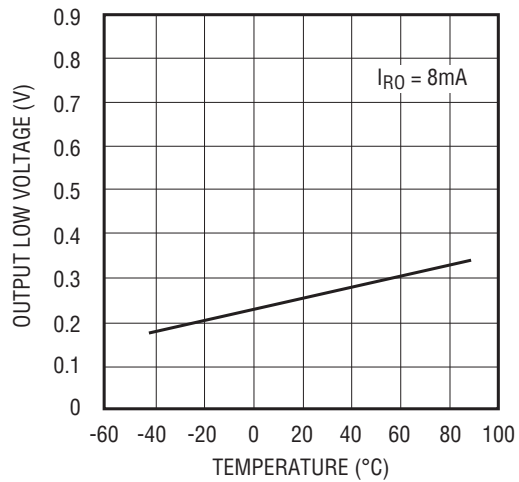

DRIVER OUTPUT CURRENT vs.
DIFFERENTIAL OUTPUT VOLTAGE

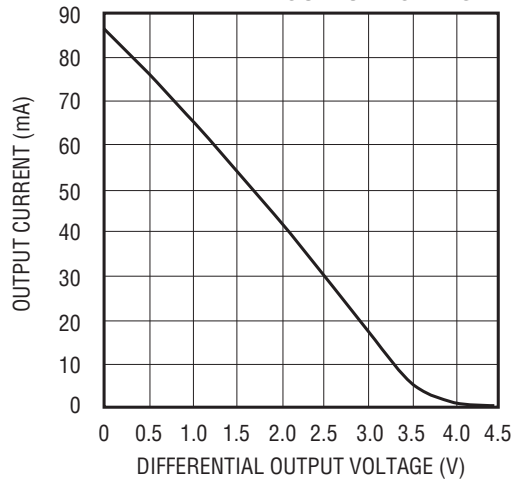

DRIVER DIFFERENTIAL OUTPUT
VOLTAGE vs. TEMPERATURE

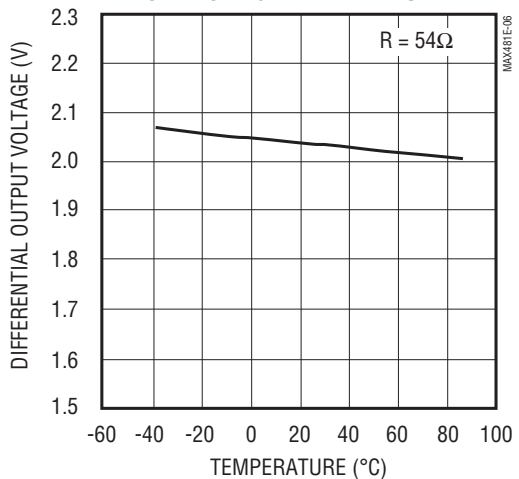



SHUTDOWN CURRENT
vs. TEMPERATURE

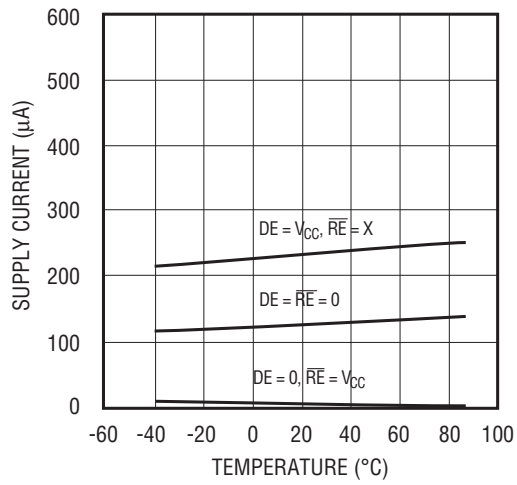

OUTPUT CURRENT vs.
DRIVER OUTPUT LOW VOLTAGE

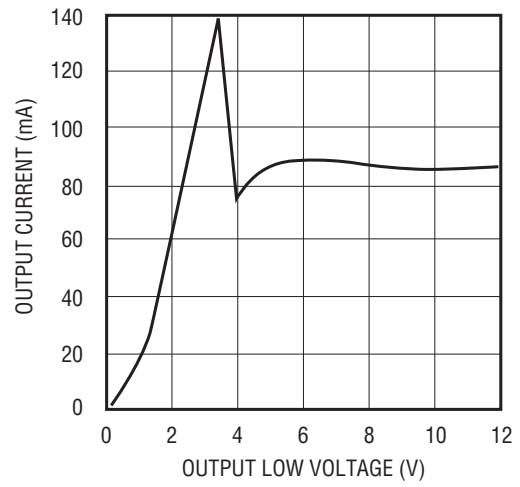

OUTPUT CURRENT vs.
DRIVER OUTPUT HIGH VOLTAGE

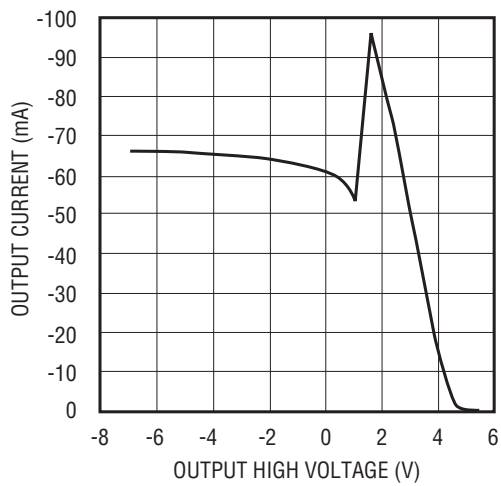



Typical Operating Circuit

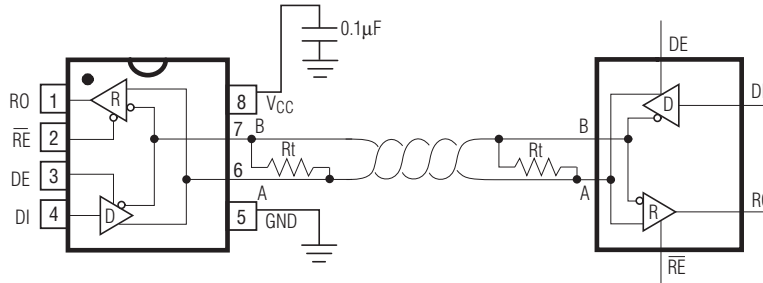

Applications Information

The MAX487ESA is low-power transceivers for RS-485 and RS-422 communications. These “E” versions of the MAX487ESA provide extra protection against ESD. These devices eliminate the need for transient suppressor diodes and the associated high capacitance loading.

The MAX487E is specified for data rates up to 250kbps. The MAX487ESA is half-duplex. In addition, driver-enable (DE) and receiver-enable (RE) pins are included on the MAX487ESA. When disabled, the driver and receiver outputs are high impedance.

±15kV ESD Protection

ESD-protection structures are incorporated on all pins to protect against electro-static discharges encountered during handling and assembly. The driver outputs and receiver inputs have extra protection against static electricity. Developed state-of-the-art structures to protect these pins against ESD of ±15kV without damage.

The ESD structures withstand high ESD in all states: normal operation, shutdown, and powered down. After an ESD event, MAX487ESA keep working without latchup. ESD protection can be tested in various ways; the transmitter outputs and receiver inputs of this product family are characterized for protection to ±15kV using the Human Body Model.

Other ESD test methodologies include IEC1000-4-2 contact discharge and IEC1000-4-2 air-gap discharge (formerly IEC801-2).

Human Body ESD Test Model

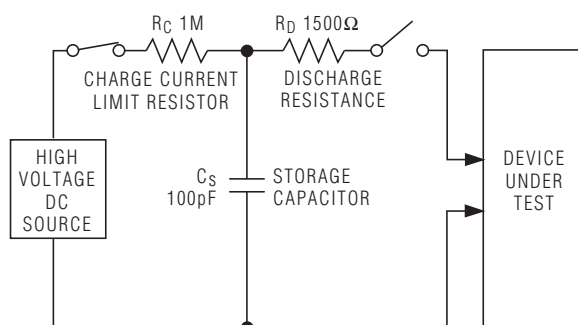

IEC1000-4-2 ESD Test Model

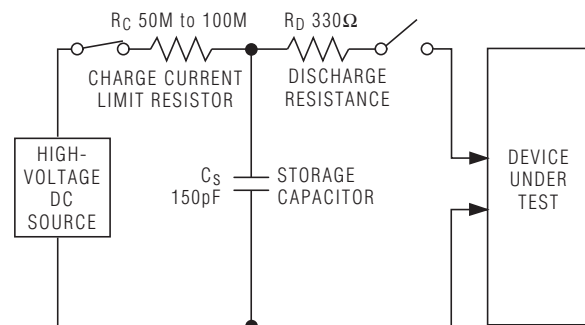



Reduced EMI and Reflections

The MAX487ESA is slew-rate limited, minimizing EMI and reducing reflections caused by improperly terminated cables.

Low-Power Shutdown Mode

A low-power shutdown mode is initiated by bringing both \overline{RE} high and DE low. The devices will not shut down unless both the driver and receiver are disabled. In shutdown, the devices typically draw only 0.5 μ A of supply current. \overline{RE} and DE may be driven simultaneously; the parts are guaranteed not to enter shutdown if \overline{RE} is high and DE is low for less than 50ns. If the inputs are in this state for at least 600ns, the parts are guaranteed to enter shutdown.

For the MAX487ESA, the tZH and tZL enable times assume the part was not in the low-power shutdown state. The tZH(SHDN) and tZL(SHDN) enable times assume the parts were shut down.

Typical Applications

The MAX487ESA transceivers are designed for bidirectional data communications on multipoint bus transmission lines. To minimize reflections, the line should be terminated at both ends in its characteristic impedance, and stub lengths off the main line should be kept as short as possible. The slew-rate-limited MAX487ESA are more tolerant of imperfect termination.

Typical Half-Duplex RS-485 Network

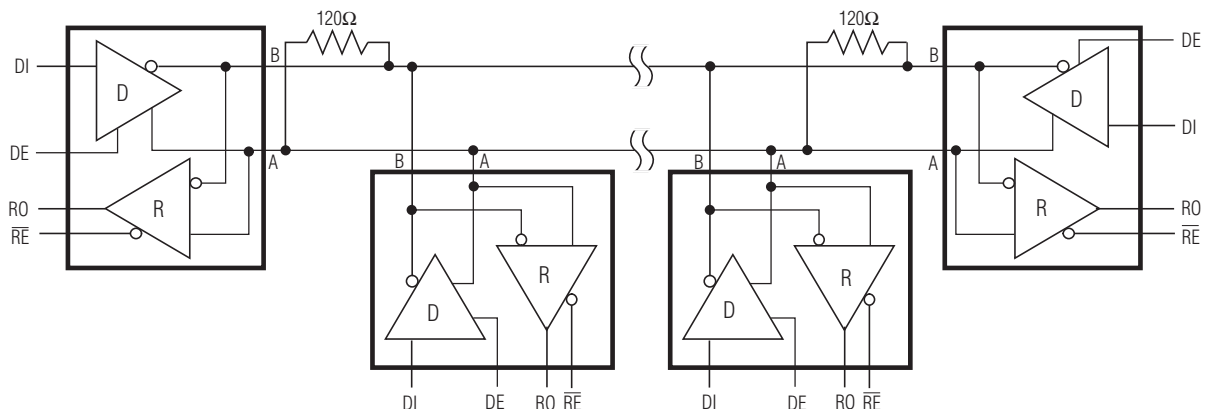



PACKAGE OUTLINE DIMENSIONS

SOP-8

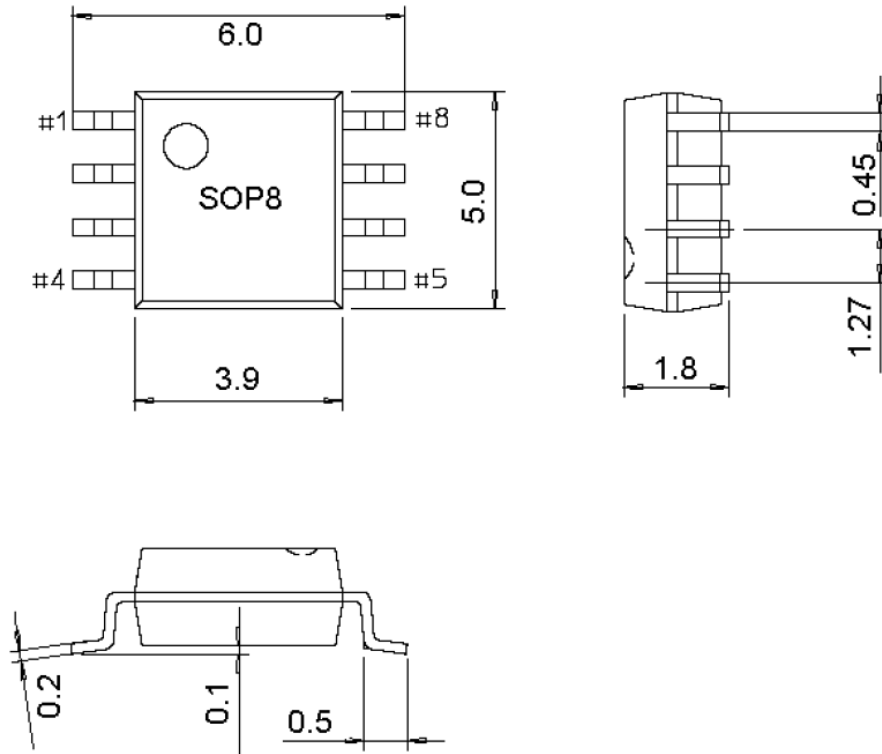



Attention

- Any and all HUA XUAN YANG ELECTRONICS products described or contained herein do not have specifications that can handle applications that require extremely high levels of reliability, such as life-support systems, aircraft's control systems, or other applications whose failure can be reasonably expected to result in serious physical and/or material damage. Consult with your HUA XUAN YANG ELECTRONICS representative nearest you before using any HUA XUAN YANG ELECTRONICS products described or contained herein in such applications.
- HUA XUAN YANG ELECTRONICS assumes no responsibility for equipment failures that result from using products at values that exceed, even momentarily, rated values (such as maximum ratings, operating condition ranges, or other parameters) listed in products specifications of any and all HUA XUAN YANG ELECTRONICS products described or contained herein.
- Specifications of any and all HUA XUAN YANG ELECTRONICS products described or contained herein stipulate the performance, characteristics, and functions of the described products in the independent state, and are not guarantees of the performance, characteristics, and functions of the described products as mounted in the customer's products or equipment. To verify symptoms and states that cannot be evaluated in an independent device, the customer should always evaluate and test devices mounted in the customer's products or equipment.
- HUA XUAN YANG ELECTRONICS CO.,LTD. strives to supply high-quality high-reliability products. However, any and all semiconductor products fail with some probability. It is possible that these probabilistic failures could give rise to accidents or events that could endanger human lives, that could give rise to smoke or fire, or that could cause damage to other property. When designing equipment, adopt safety measures so that these kinds of accidents or events cannot occur. Such measures include but are not limited to protective circuits and error prevention circuits for safe design, redundant design, and structural design.
- In the event that any or all HUA XUAN YANG ELECTRONICS products(including technical data, services) described or contained herein are controlled under any of applicable local export control laws and regulations, such products must not be exported without obtaining the export license from the authorities concerned in accordance with the above law.
- No part of this publication may be reproduced or transmitted in any form or by any means, electronic or mechanical, including photocopying and recording, or any information storage or retrieval system, or otherwise, without the prior written permission of HUA XUAN YANG ELECTRONICS CO.,LTD.
- Information (including circuit diagrams and circuit parameters) herein is for example only ; it is not guaranteed for volume production. HUA XUAN YANG ELECTRONICS believes information herein is accurate and reliable, but no guarantees are made or implied regarding its use or any infringements of intellectual property rights or other rights of third parties.
- Any and all information described or contained herein are subject to change without notice due to product/technology improvement, etc. When designing equipment, refer to the "Delivery Specification" for the HUA XUAN YANG ELECTRONICS product that you intend to use.