

REVISIONS

REV	DESCRIPTION	DATE	APPV
A	INITIAL RELEASE FROM X1	6-SEP-11	BPM
B	ADDED TAPE AND REEL P/N AND PAGE SHOWING DIMS	28-MAY-13	SAH

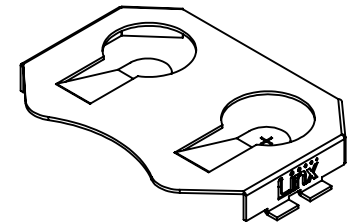
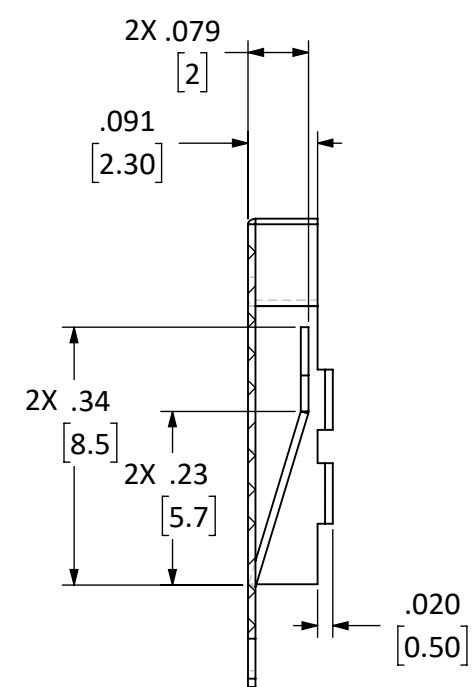
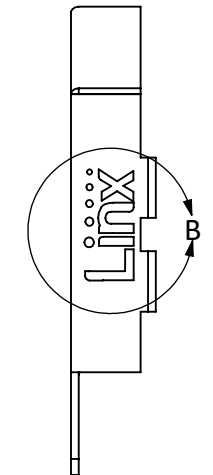
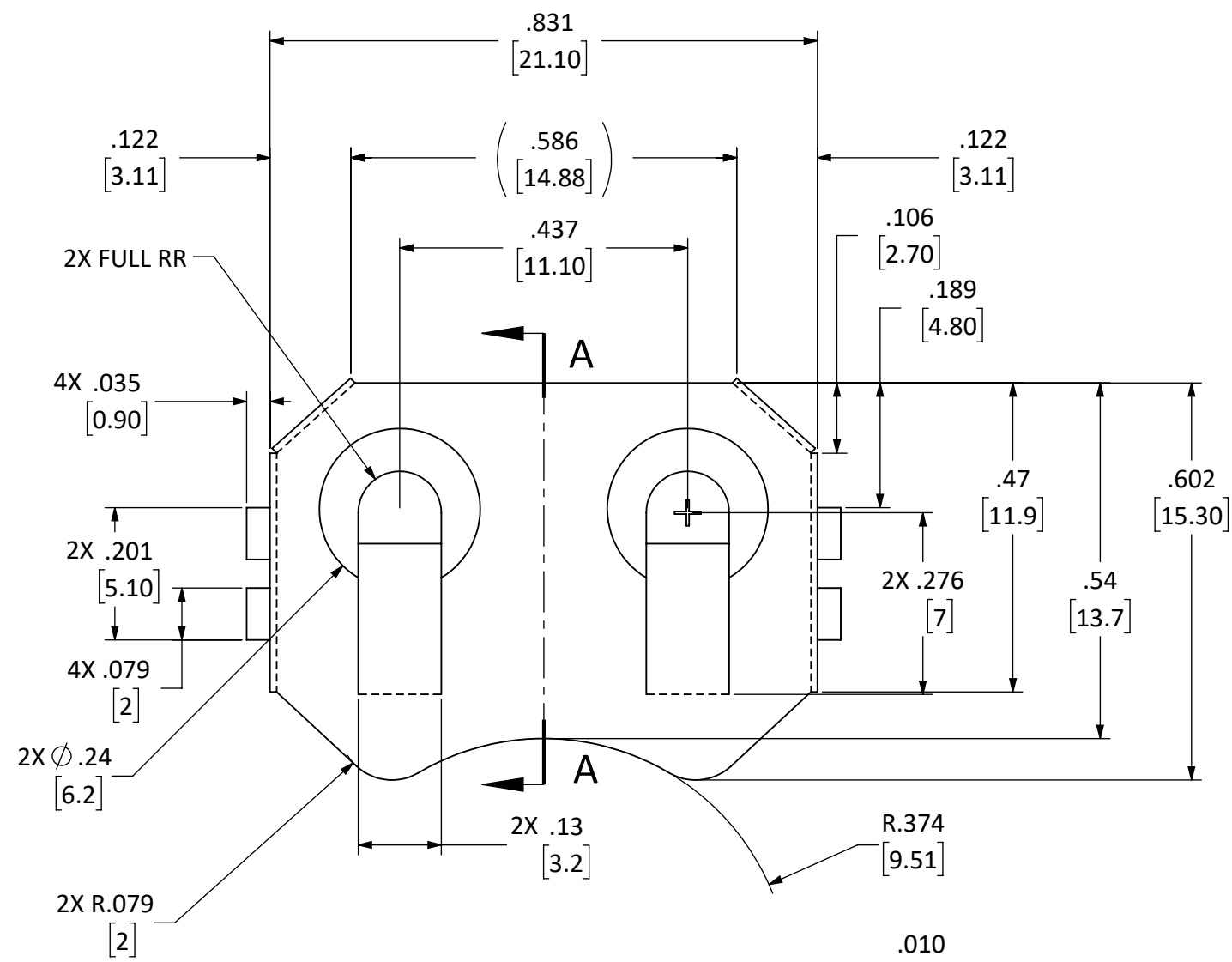

SECTION A-A

- NOTES: (UNLESS OTHERWISE SPECIFIED)
1. ALL DIMENSIONS ARE IN INCHES [mm].
 2. DIMENSIONS APPLY AFTER FINISHING.
 3. MANUFACTURE TO BE COMPLIANT WITH EU RoHS DIRECTIVE.
 4. SAFETY BREAK ALL SHARP CORNERS AND EDGES .02 MAXIMUM.
 5. MINIMUM INSIDE BEND RADII 0.00 [0.0].
 6. EMBOSS LINX LOGO AS SHOWN, MINIMUM 0.002 [0.05] DEEP, PER FILE *LINX LOGO BLACK TRUNCATED.AI*.

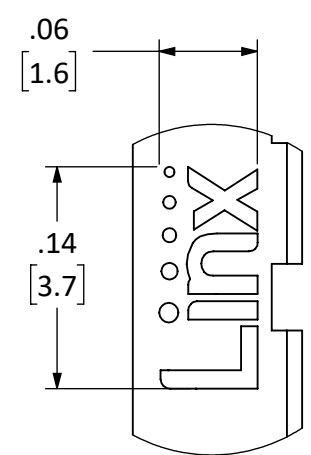
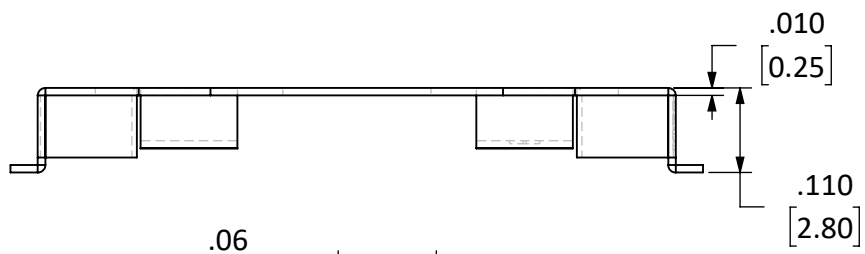

DETAIL B
SCALE 8 : 1

PART NUMBER	PACKAGING
BAT-HLD-002-SMT	BULK
BAT-HLD-002-SMT-TR	TAPE & REEL

WARNING: THIS DRAWING CONTAINS PROPRIETARY INFORMATION THAT IS THE SOLE PROPERTY OF LINX TECHNOLOGIES, AND SHALL BE TREATED AS SUCH. NO DISCLOSURE OR REPRODUCTION OF THIS DOCUMENT IS PERMITTED, IN WHOLE OR IN PART, WITHOUT THE EXPRESS WRITTEN PERMISSION OF LINX TECHNOLOGIES OR ITS DESIGNATED AGENTS.

STE 159 ORT LANE
connectivity MERLIN, OR 97532

MATERIAL: PHOSPHOR BRONZE #C-5191	INTERPRET DIMENSIONS AND TOLERANCES PER ASME Y14.5. .X ±2.0 .XX ±1.0 .XXX ±.500	ANGLES: ±1° SURFACE:	PROJECTION: 	TITLE: BATTERY HOLDER CR2016, SURFACE MOUNT
WEIGHT:	FINISH: NICKEL PLATE	DRAWN: B.MURPHY ENGR: S.HOGAN	DT: 22-MAY-13 DT: 28-MAY-13	SIZE DWG. NO. B C-BAT-HLD-002-SMT-xx
SCALE: 4:1		DO NOT SCALE DRAWING		REV A
				SHEET 1 OF 2

8 7 6 5 4 3 2 1

8 7 6 5 4 3 2 1 LDCDFB_B

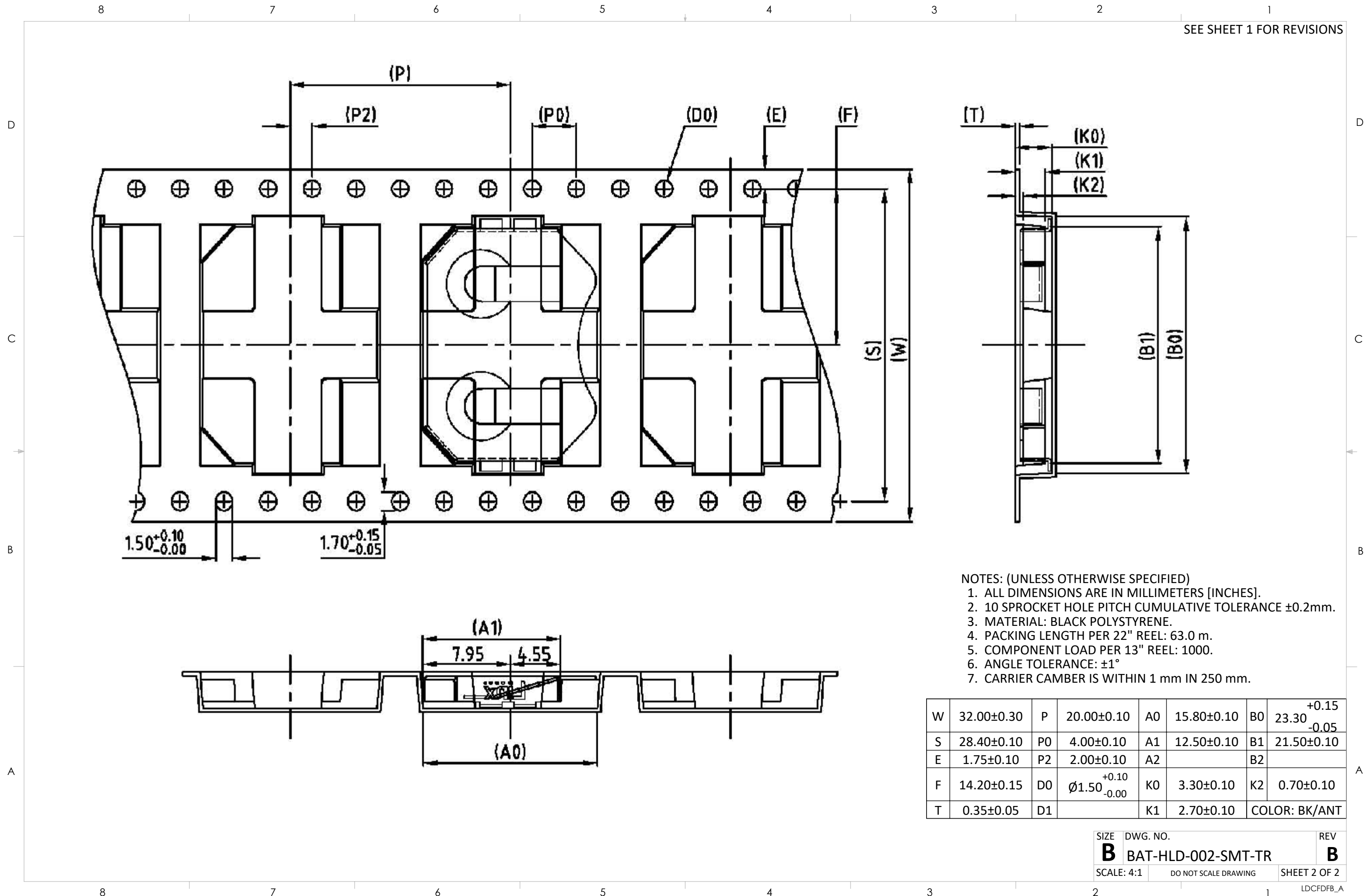

- NOTES: (UNLESS OTHERWISE SPECIFIED)
1. ALL DIMENSIONS ARE IN MILLIMETERS [INCHES].
 2. 10 SPROCKET HOLE PITCH CUMULATIVE TOLERANCE $\pm 0.2\text{mm}$.
 3. MATERIAL: BLACK POLYSTYRENE.
 4. PACKING LENGTH PER 22" REEL: 63.0 m.
 5. COMPONENT LOAD PER 13" REEL: 1000.
 6. ANGLE TOLERANCE: $\pm 1^\circ$
 7. CARRIER CAMBER IS WITHIN 1 mm IN 250 mm.

W	32.00 ± 0.30	P	20.00 ± 0.10	A0	15.80 ± 0.10	B0	23.30 ^{+0.15} _{-0.05}
S	28.40 ± 0.10	P0	4.00 ± 0.10	A1	12.50 ± 0.10	B1	21.50 ± 0.10
E	1.75 ± 0.10	P2	2.00 ± 0.10	A2		B2	
F	14.20 ± 0.15	D0	$\varnothing 1.50$ ^{+0.10} _{-0.00}	K0	3.30 ± 0.10	K2	0.70 ± 0.10
T	0.35 ± 0.05	D1		K1	2.70 ± 0.10	COLOR: BK/ANT	

SIZE	DWG. NO.	REV
B	BAT-HLD-002-SMT-TR	B
SCALE: 4:1	DO NOT SCALE DRAWING	SHEET 2 OF 2