



# TAOGLAS®



# Datasheet

**Part No:**  
SWLP.2450.12.4.B.02

**Description**  
12\*12\*4mm 2.4GHz Wi-Fi SMD Patch Antenna

**Features:**  
2.4 - 2.5GHz Wi-Fi Patch Antenna  
For Wi-Fi/WLAN/ISM/Zigbee Industrial Applications  
High Gain 2dBi  
RoHS & Reach Compliant

<b>1.</b>	<b>Introduction</b>	<b>3</b>
<b>2.</b>	<b>Specification</b>	<b>4</b>
<b>3.</b>	<b>Antenna Characteristics</b>	<b>5</b>
<b>4.</b>	<b>Radiation Patterns</b>	<b>9</b>
<b>5.</b>	<b>Mechanical Drawing</b>	<b>13</b>
<b>6.</b>	<b>Antenna Integration Guide</b>	<b>14</b>
<b>7.</b>	<b>Solder Reflow Profile</b>	<b>20</b>
<b>8.</b>	<b>Packaging</b>	<b>21</b>
<hr/>		
	Changelog	22

Taoglas makes no warranties based on the accuracy or completeness of the contents of this document and reserves the right to make changes to specifications and product descriptions at any time without notice. Taoglas reserves all rights to this document and the information contained herein. Reproduction, use or disclosure to third parties without express permission is strictly prohibited.



# 1. Introduction

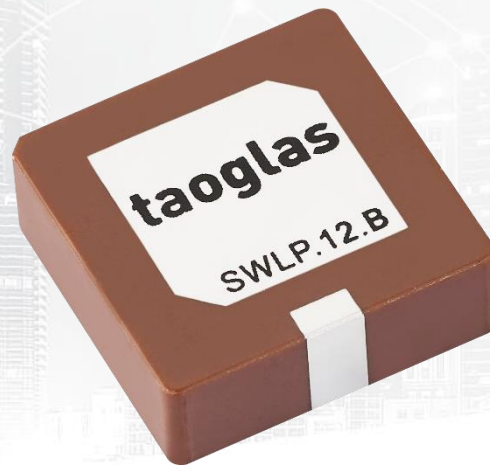

This 12x12x4mm high gain 2.4GHz patch antenna is ideally suited for high performance industrial applications in the 2.4GHz Wi-Fi, ISM, and Zigbee bands. This product has highest gain at broadside, most suitable for fixed wireless applications where transmission and reception is focused to one hemisphere of the device, for example a wireless meter on a reinforced concrete wall. It can also be placed anywhere on the device ground-plane, unlike most chip or loop antennas which need to be edge mounted.

Many module manufacturers specify peak gain limits for any antennas that are to be connected to that module. Those peak gain limits are based on free-space conditions. In practice, the peak gain of an antenna tested in free space can degrade by at least 1 or 2dBi when put inside a device. So ideally you should go for a slightly higher peak gain antenna than mentioned on the module specification to compensate for this effect, giving you better performance.

Upon testing of any of our antennas with your device and a selection of appropriate layout, integration technique, or cable, Taoglas can make sure any of our antennas' peak gain will be below the peak gain limits. Taoglas can then issue a specification and/or report for the selected antenna in your device that will clearly show it complying with the peak gain limits, so you can be assured you are meeting regulatory requirements for that module.

For example, a module manufacturer may state that the antenna must have less than 2dBi peak gain, but you don't need to select an embedded antenna that has a peak gain of less than 2dBi in free space. This will give you a less optimized solution. It is better to go for a slightly higher free-space peak gain of 3dBi or more if available. Once that antenna gets integrated into your device, performance will degrade below this 2dBi peak gain due to the effects of GND plane, surrounding components, and device housing. If you want to be absolutely sure, contact Taoglas and we will test. Choosing a Taoglas antenna with a higher peak gain than what is specified by the module manufacturer and enlisting our help will ensure you are getting the best performance possible without exceeding the peak gain limits.

## 2. Specification

### Wi-Fi Electrical

Band	Frequency (MHz)	Efficiency (%)	Average Gain (dB)	Peak Gain (dBi)	Impedance	Polarization	Radiation Pattern	Max. input power
Wi-Fi 2.4GHz	2400-2500	79.4	-1.00	5.11	50 $\Omega$	RHCP	Omni	2W

### Mechanical

Dimensions	12*12*4mm
Weight	4g

### Environmental

Operating Temperature	-40°C to +85°C
Storage Temperature	-40°C to +85°C
Termination	Ag (Environmentally Friendly Pb Free)
Moisture Sensitivity Level (MSL)	3 (168 Hours)

### 3. Antenna Characteristics

#### 3.1 Return Loss

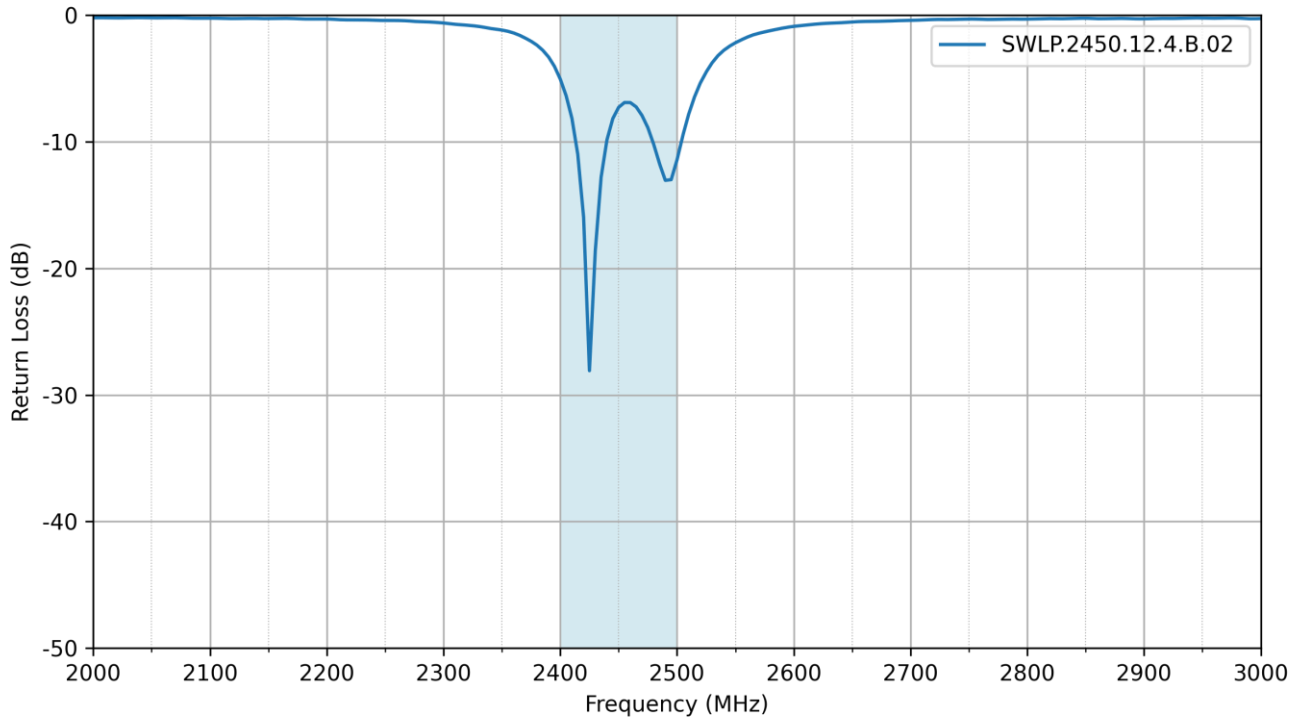

#### 3.2 VSWR

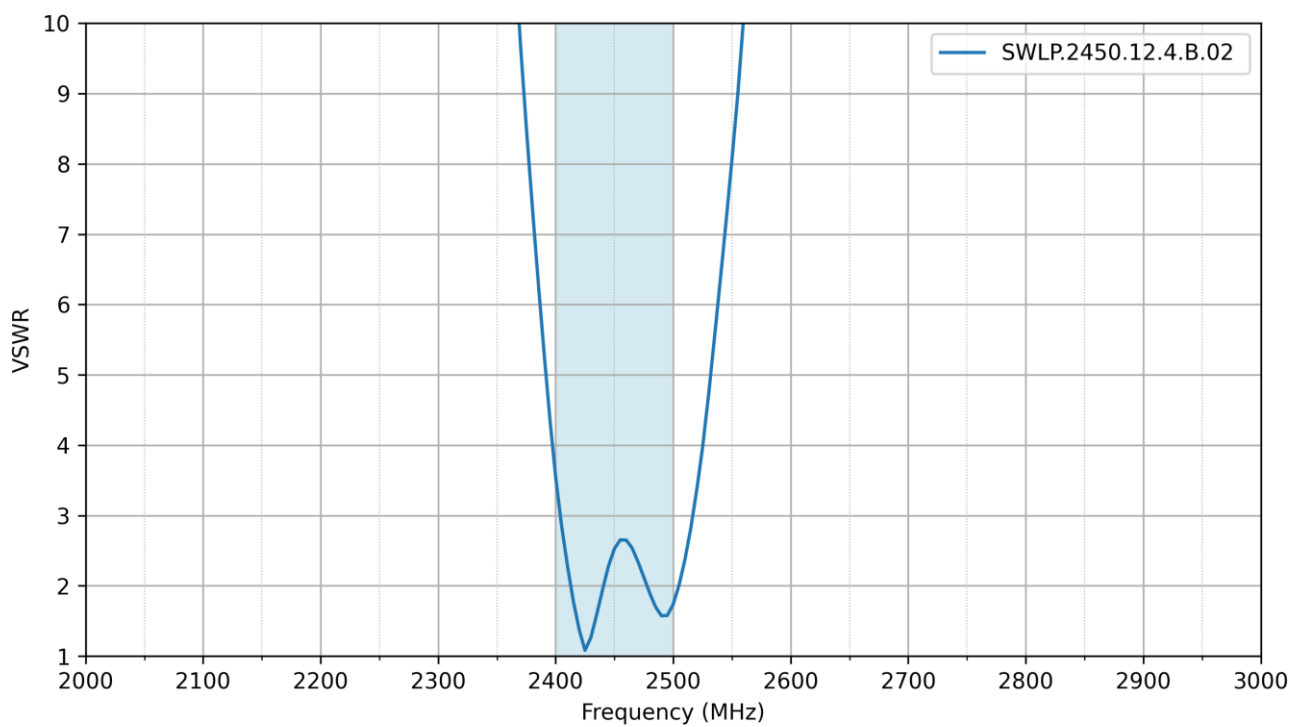

### 3.3 Efficiency

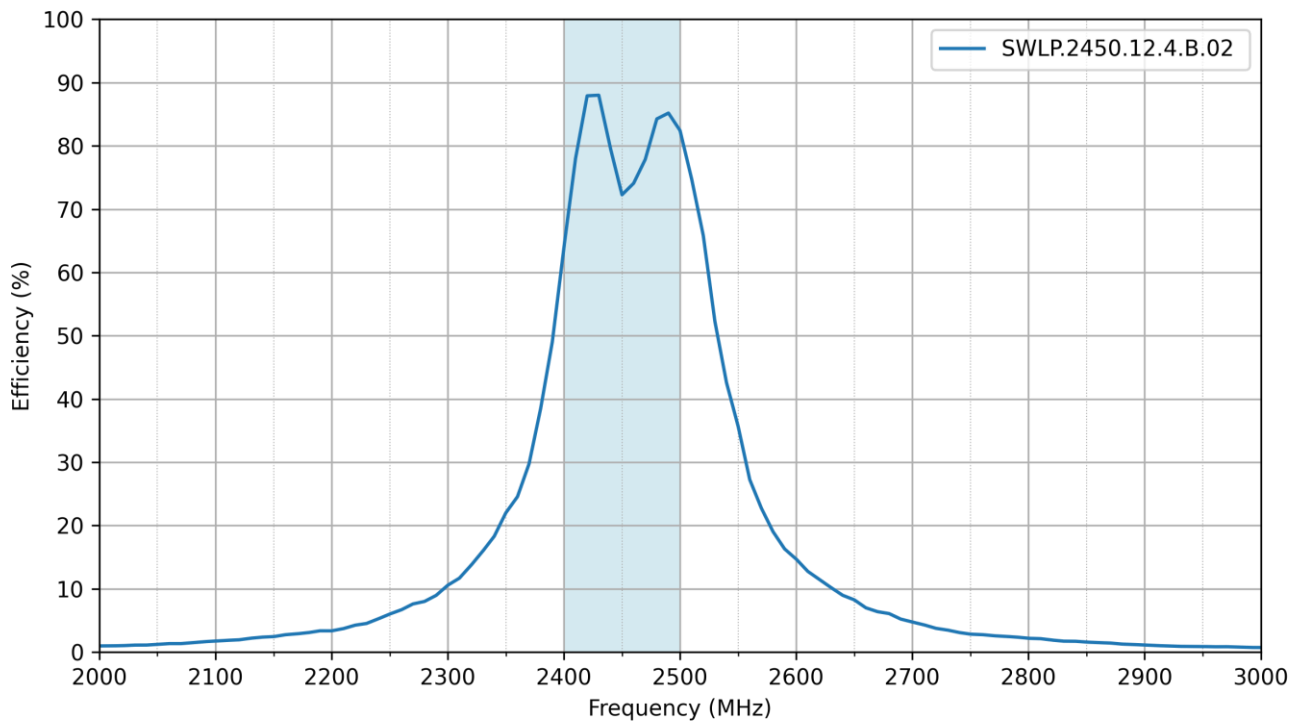

### 3.4 Average Gain

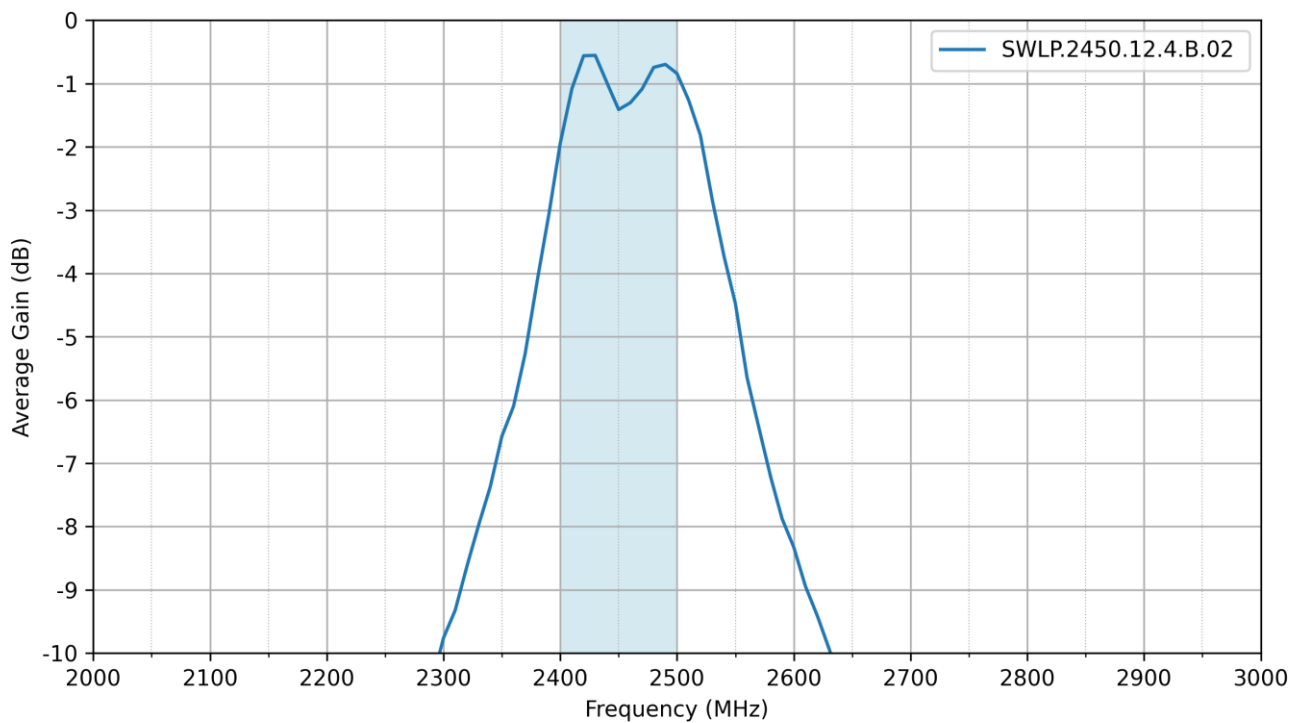

### 3.5 Peak Gain

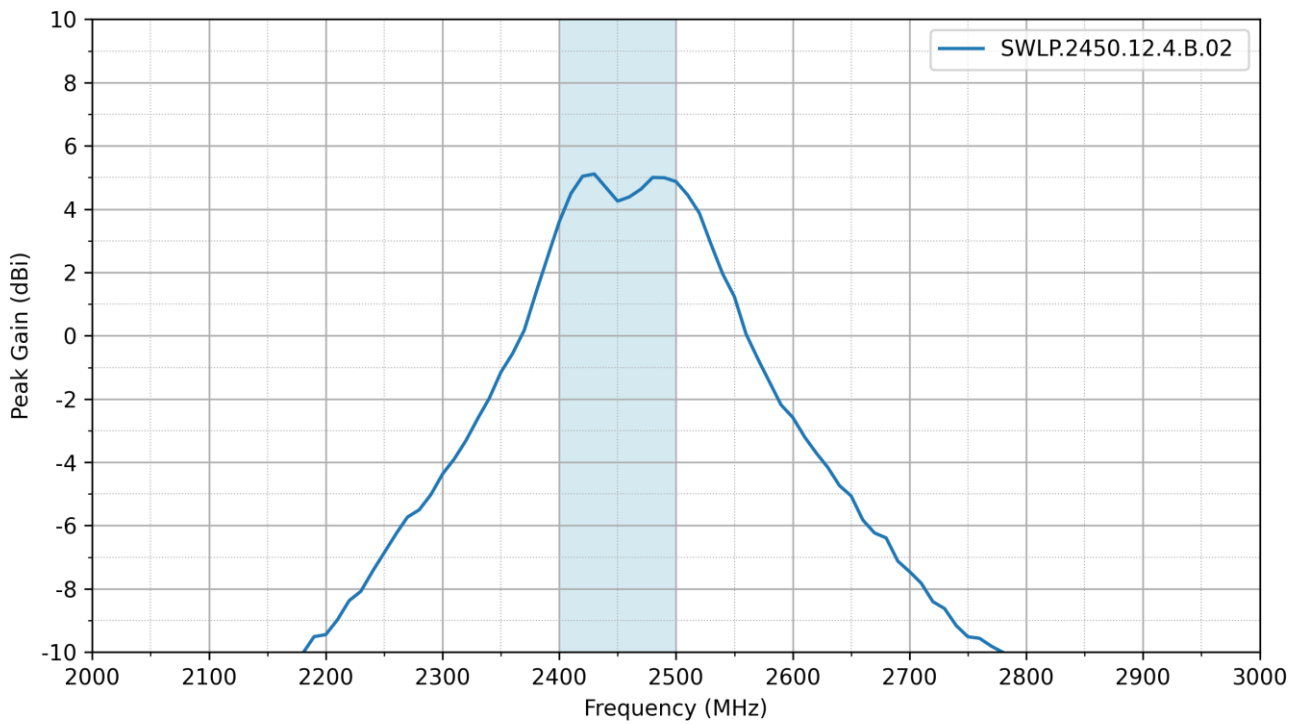

### 3.6 Axial Ratio

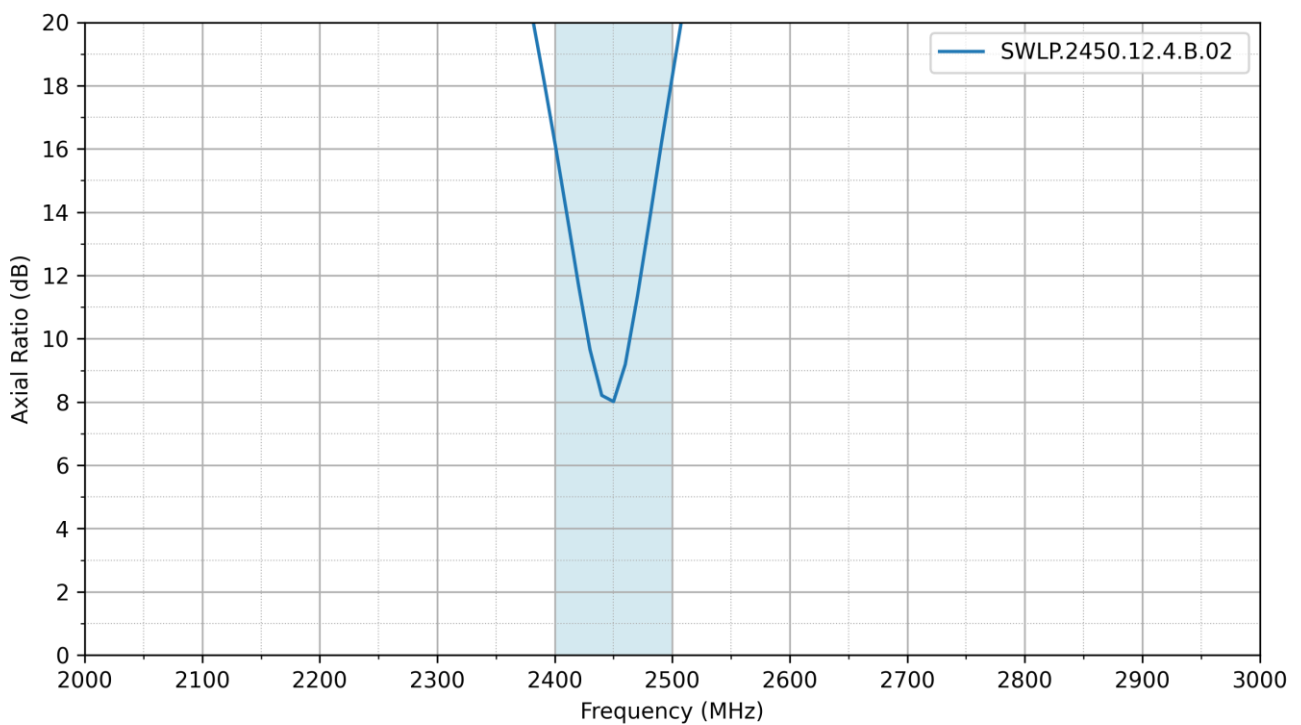

### 3.7 Axial Ratio vs Angle for Phi=0

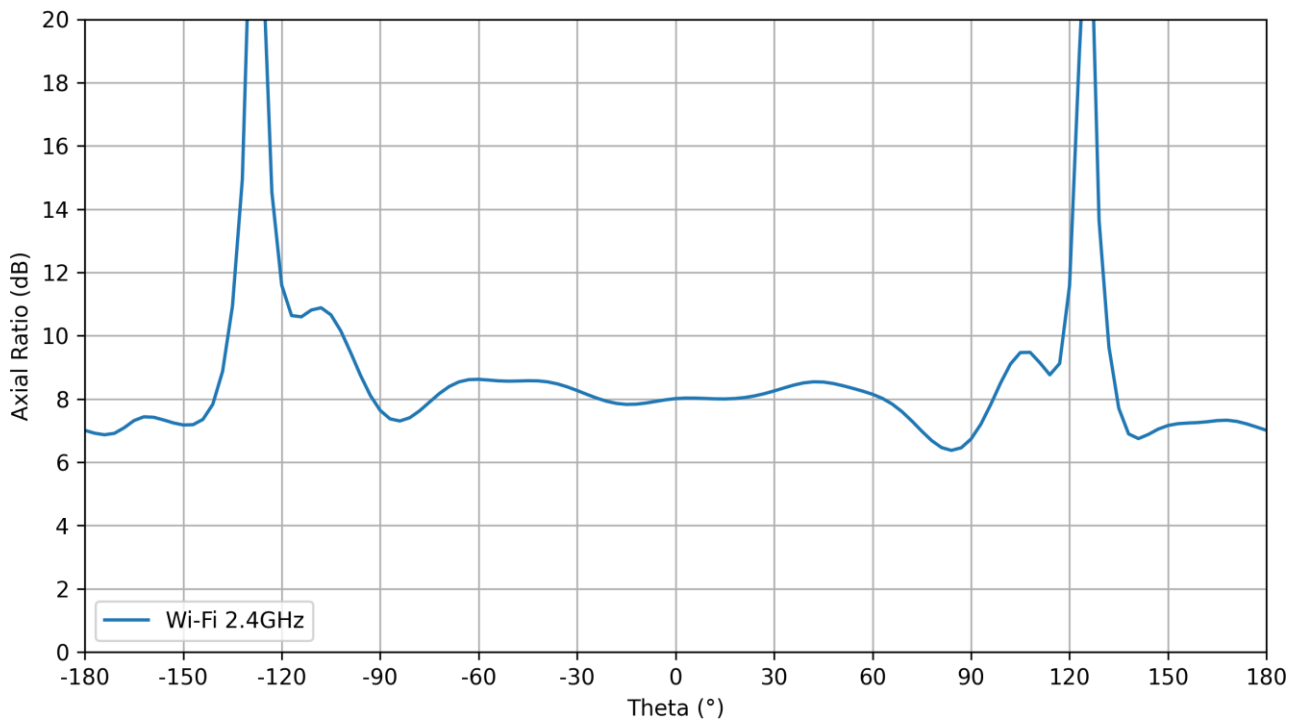

### 3.8 Axial Ratio vs Angle for Phi=90

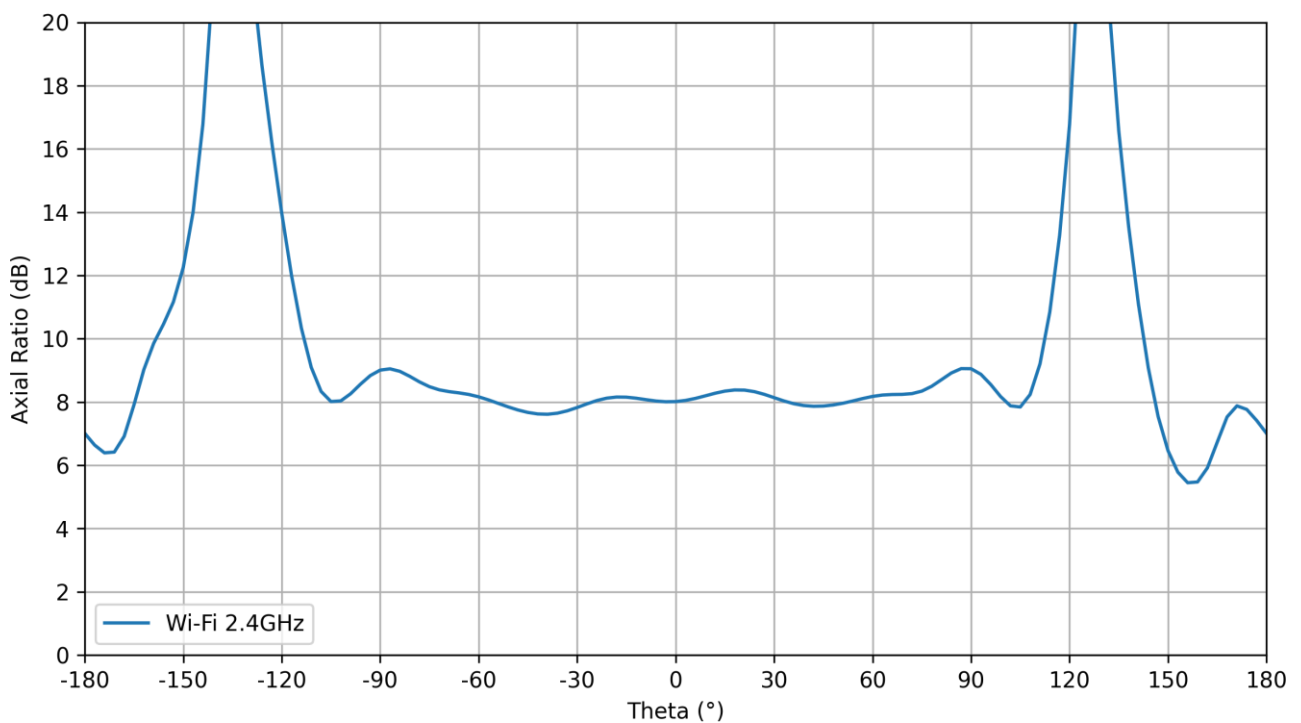



## 4. Radiation Patterns

### 4.1 Test Setup

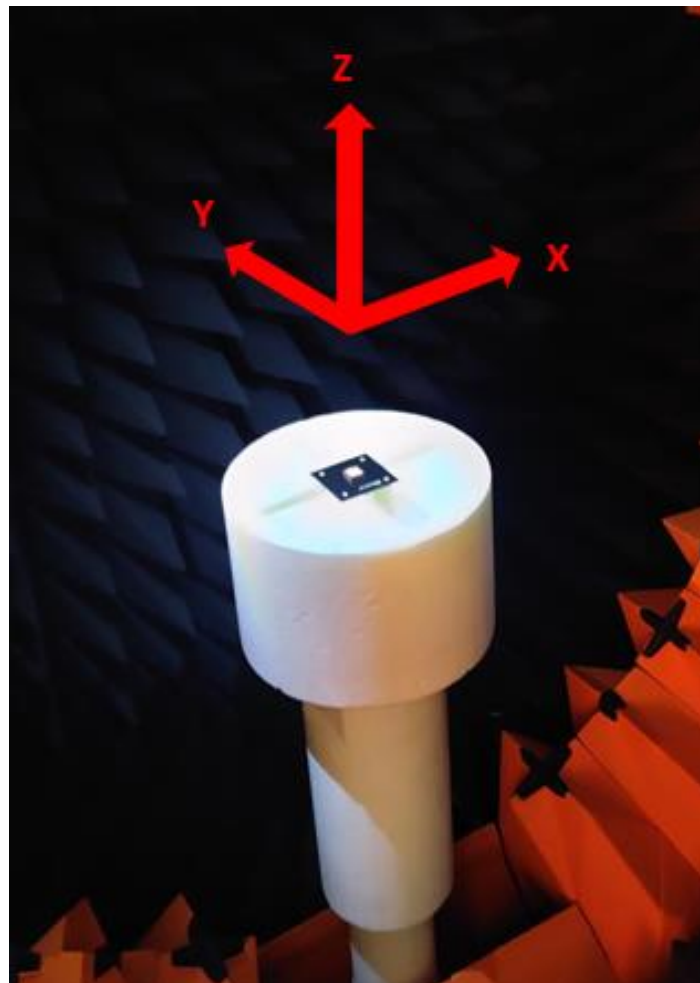
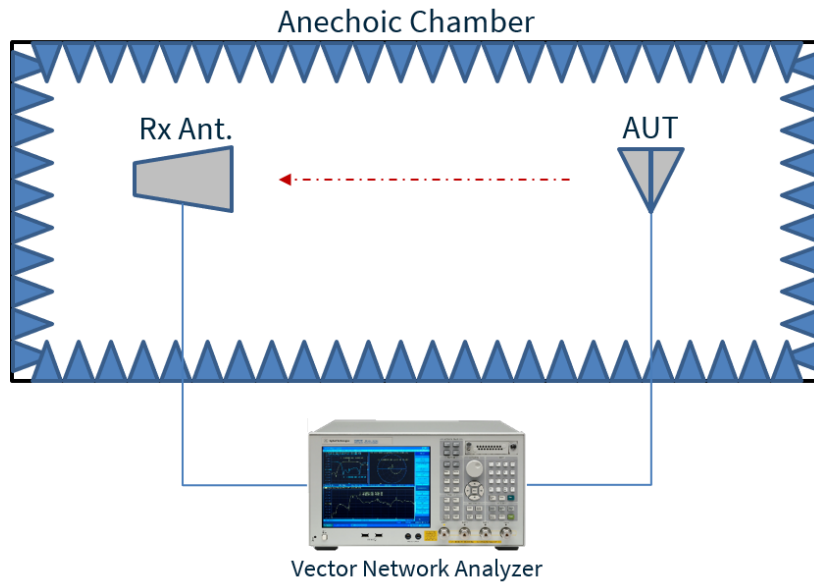

4.2 Patterns at 2400 MHz

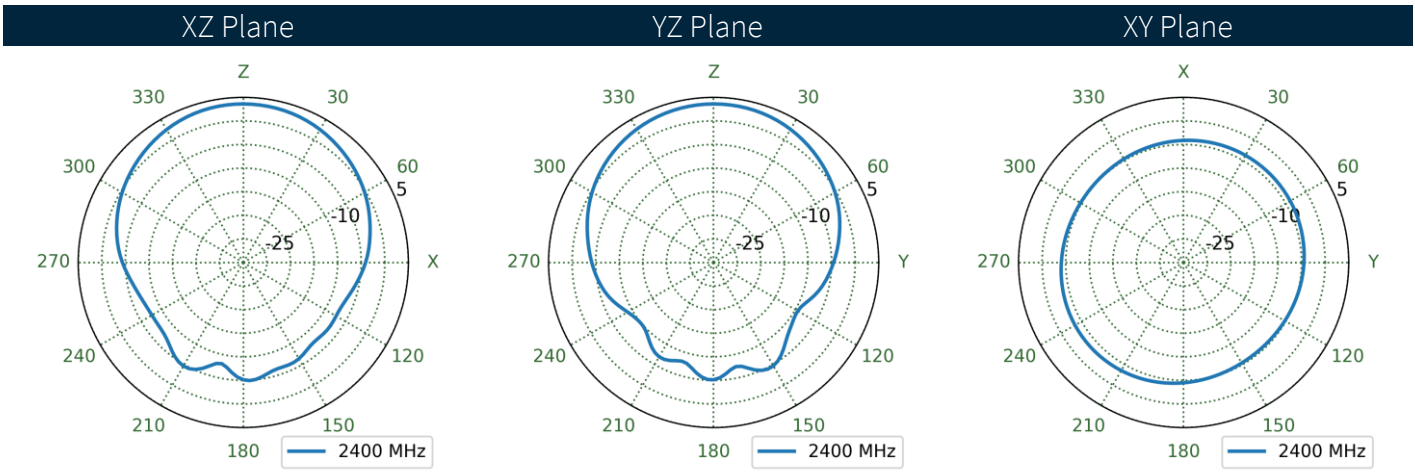
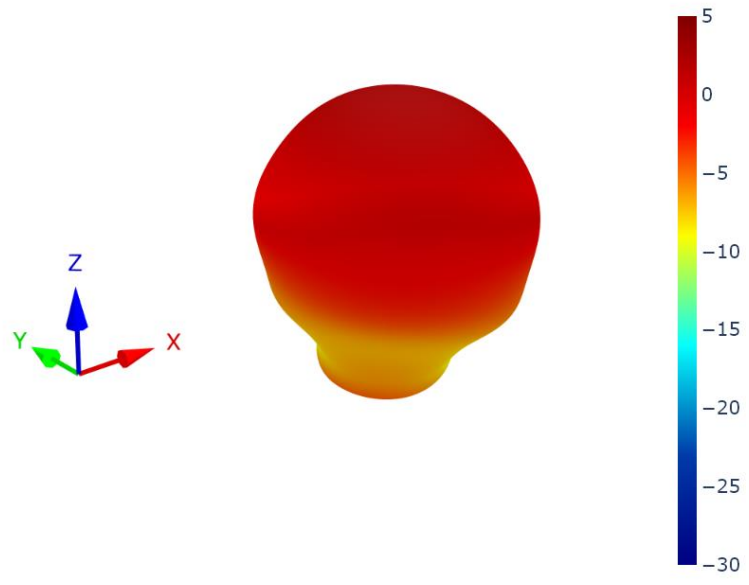

4.3 Patterns at 2450 MHz

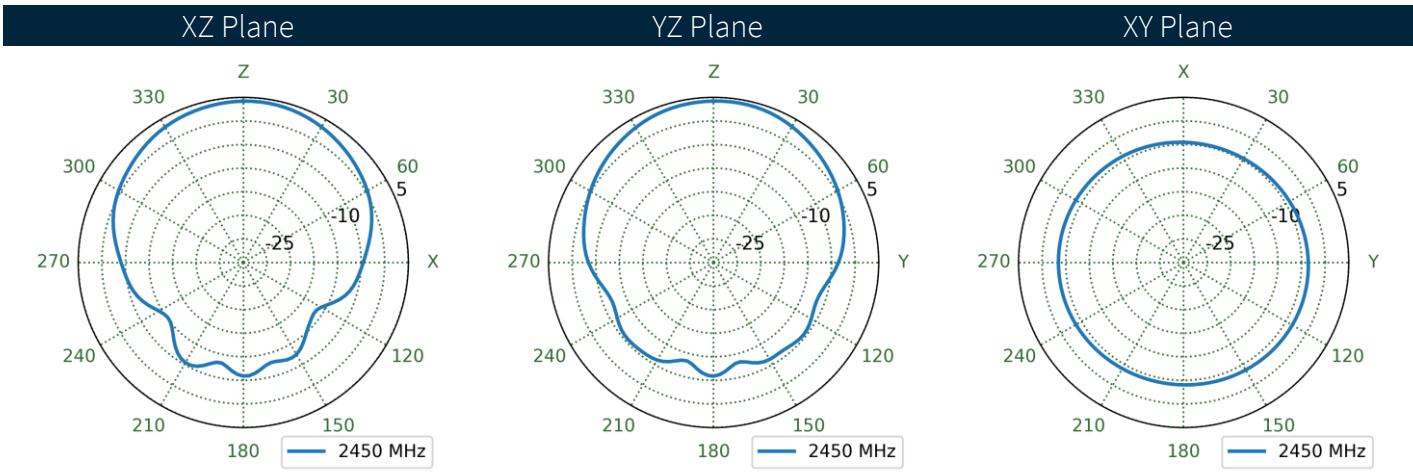
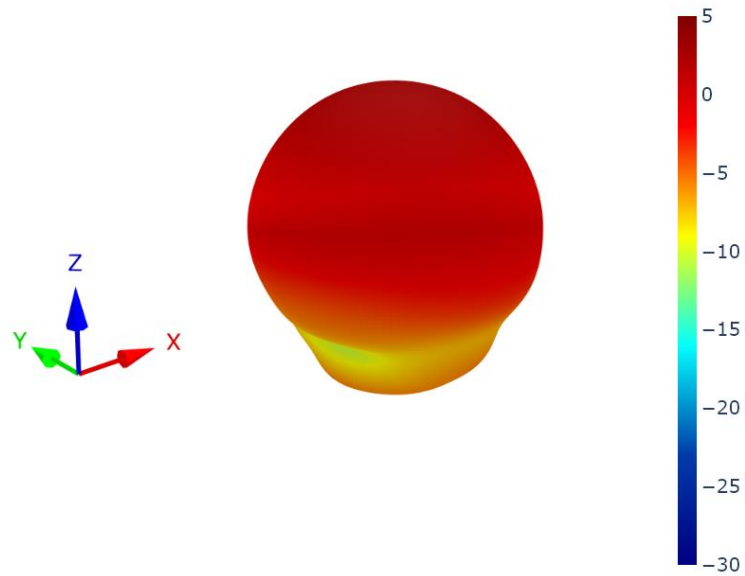

4.4 Patterns at 2500 MHz

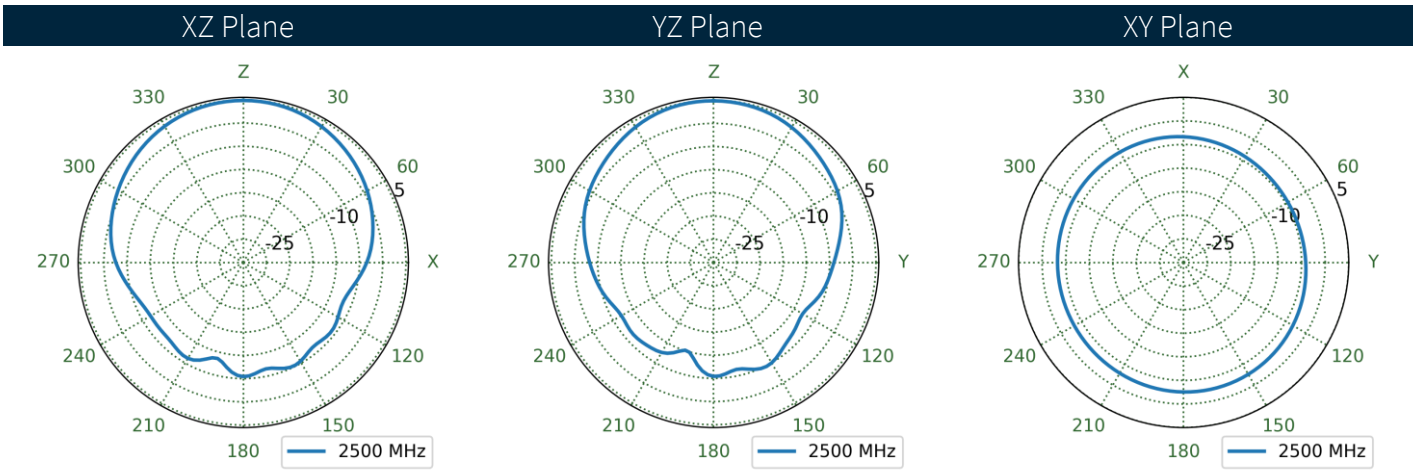
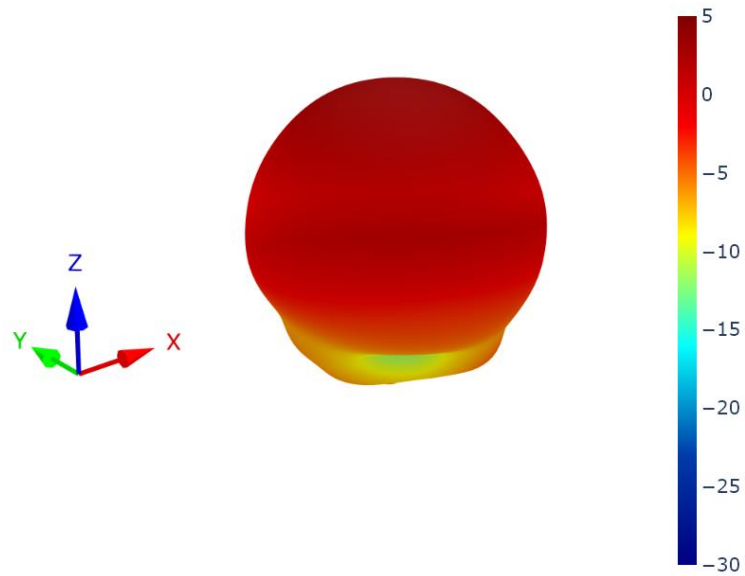

# 5. Mechanical Drawing

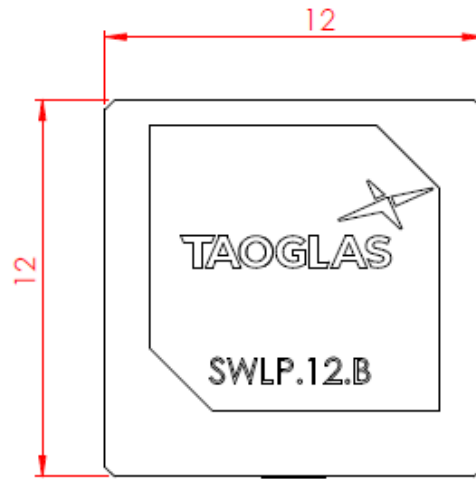

TOP VIEW

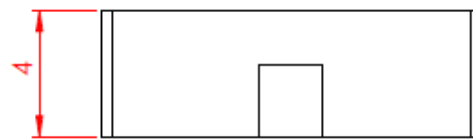

FRONT VIEW

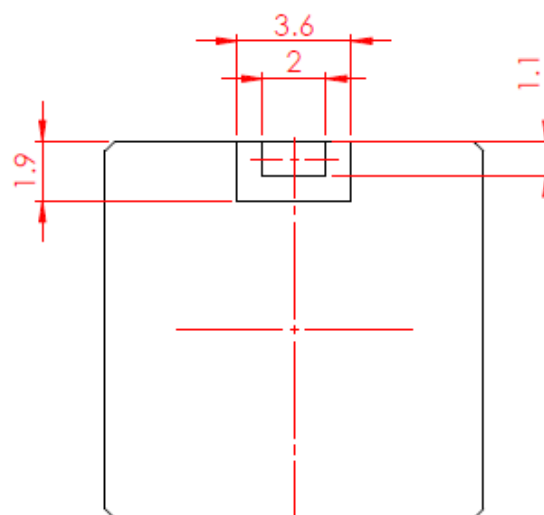

BOTTOM VIEW

## 6. Antenna Integration Guide

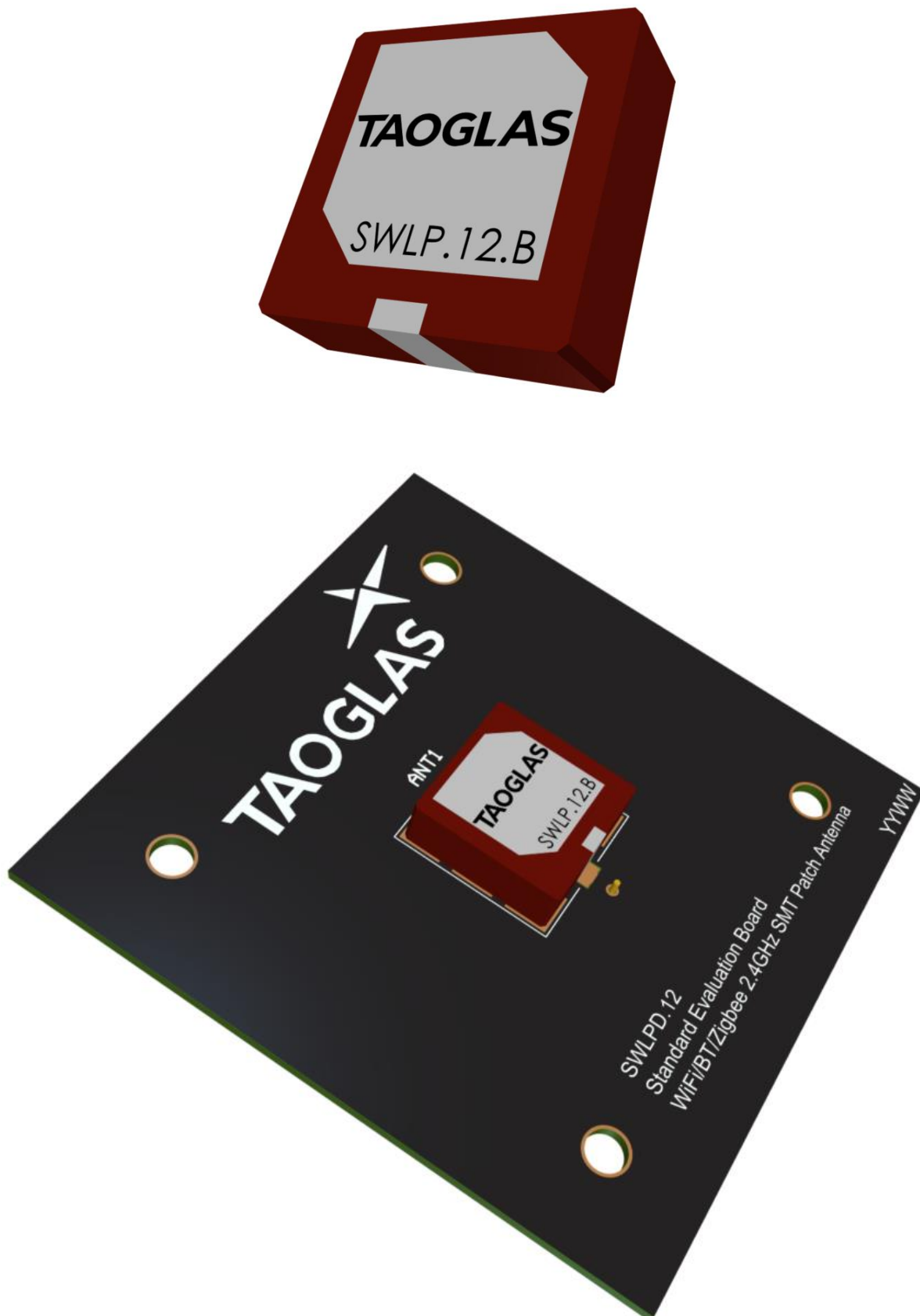

## 6.1 Schematic and Symbol Definition

The circuit symbol for the antenna is shown below. The antenna has 9 pins as indicated below.

Pin	Description
1	RF Feed
2, 3, 4, 5, 6, 7, 8, 9	GND

TAOGLAS\_SWLP.2450.12.4.B.02  
ANT1

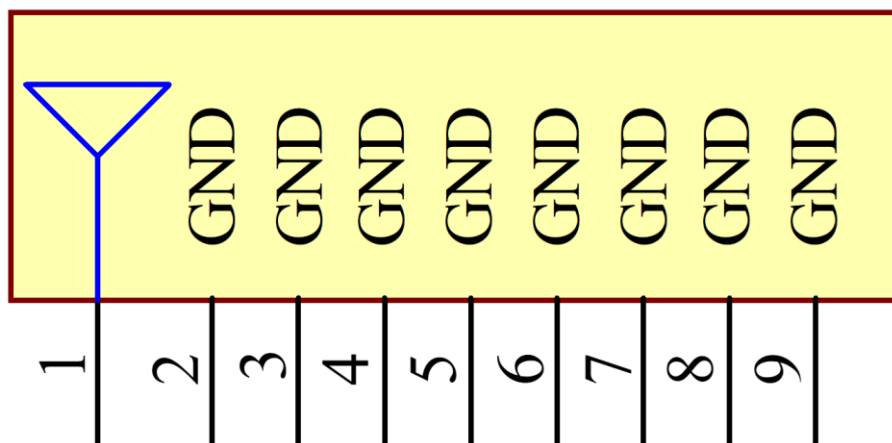

## 6.2 Antenna Integration

The antenna should be placed at the center of the ground plane with a length and width of 50mm. Maintaining a square symmetric ground plane shape and symmetric environment around the antenna is critical to maintaining the excellent axial ratio and phase center performance shown in this datasheet.

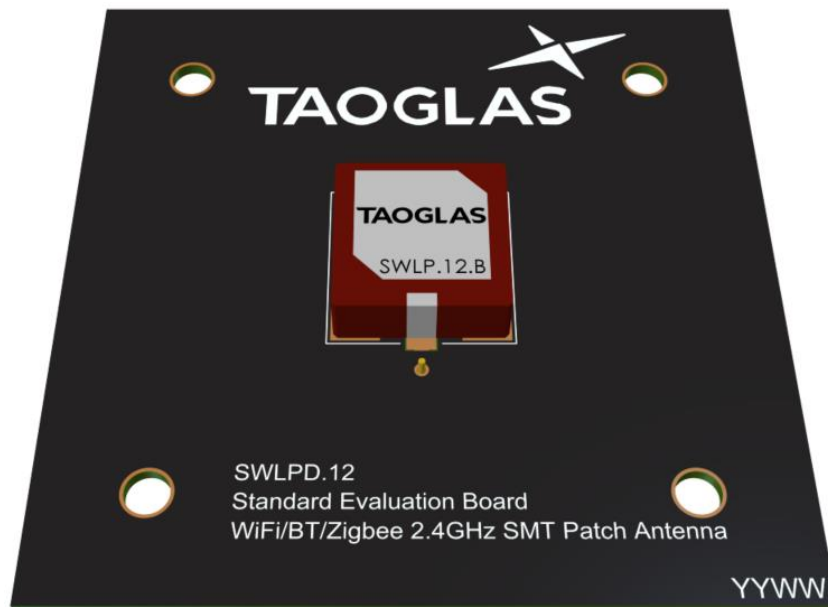

Top Side with Solder Mask

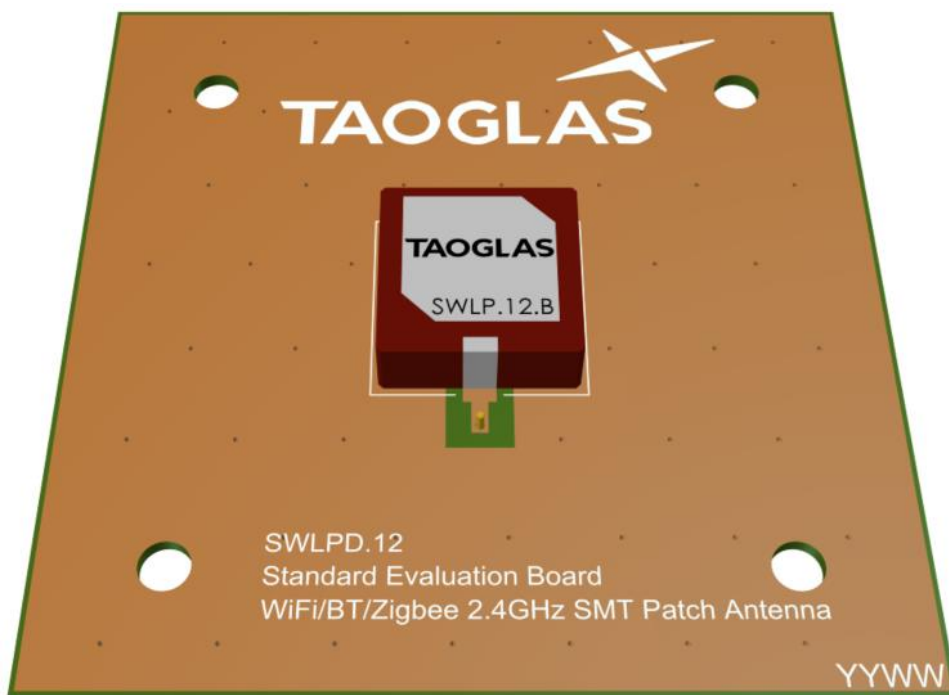

Top Side without Solder Mask



## 6.3 PCB Layout

The footprint and clearance on the PCB must comply with the antenna specification. The PCB layout shown in the diagram below demonstrates the antenna footprint.

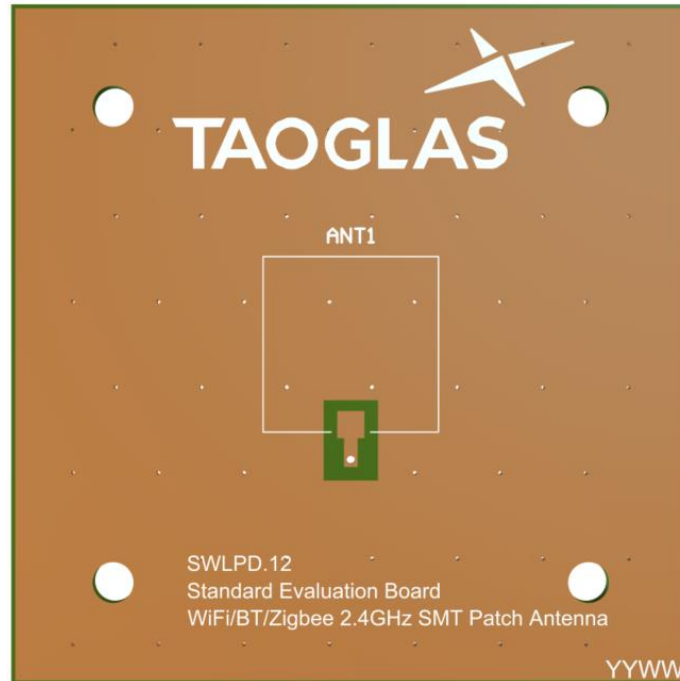

Top Side

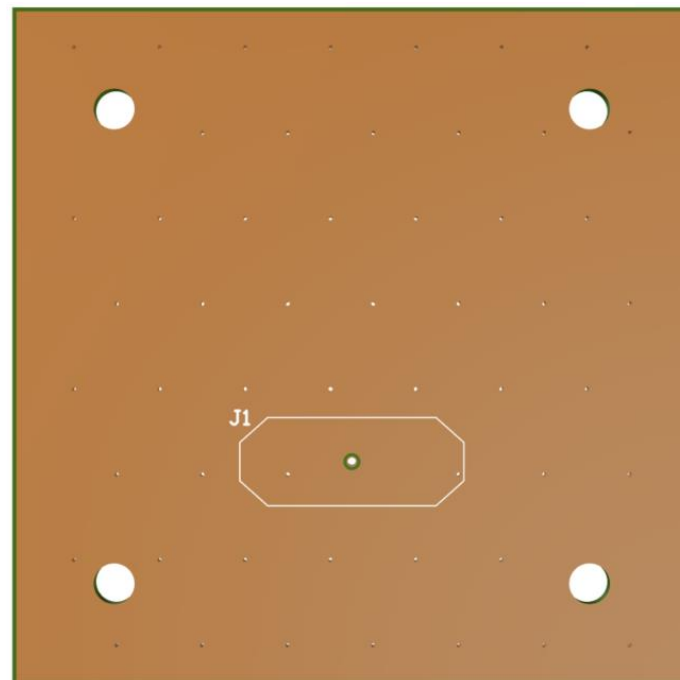

Bottom Side

## 6.4 Evaluation Board

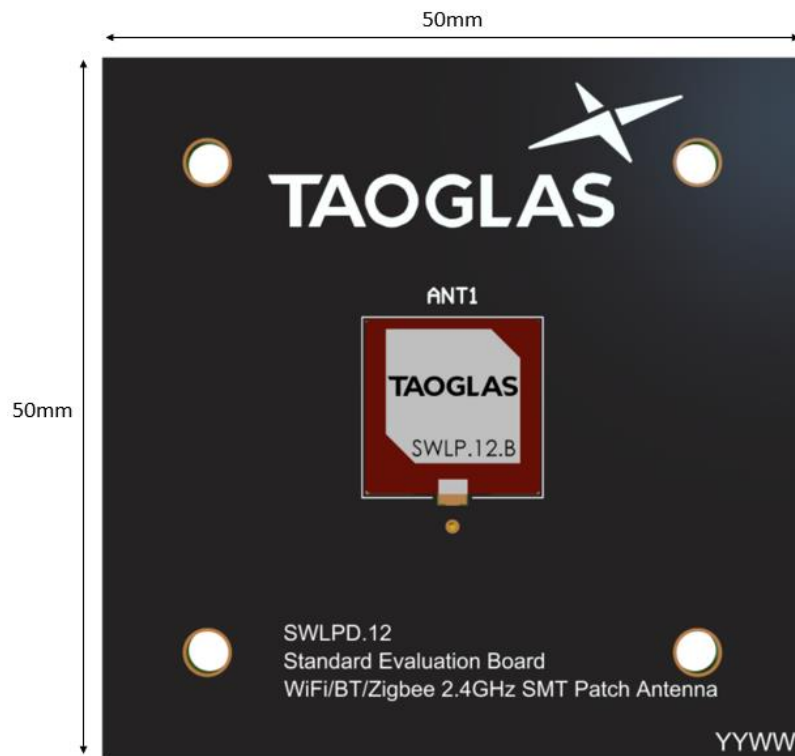

Top Side

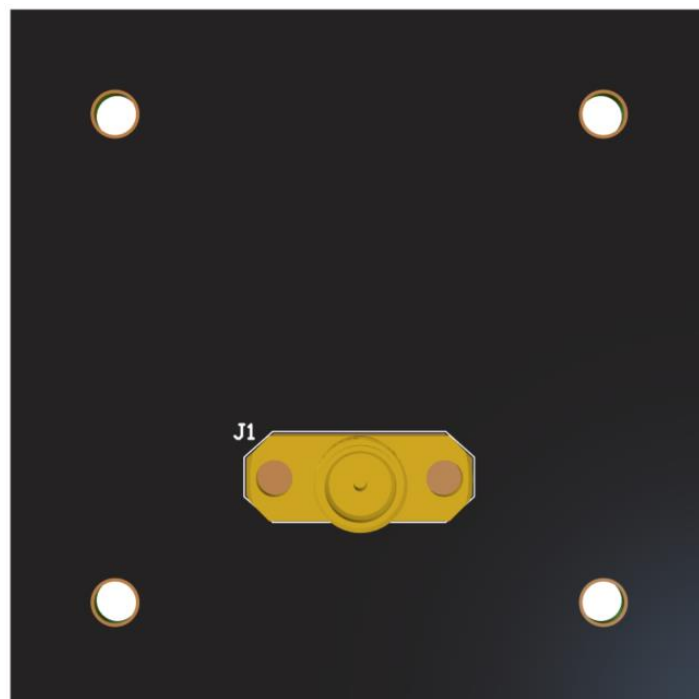

Bottom Side

## 6.5 Footprint

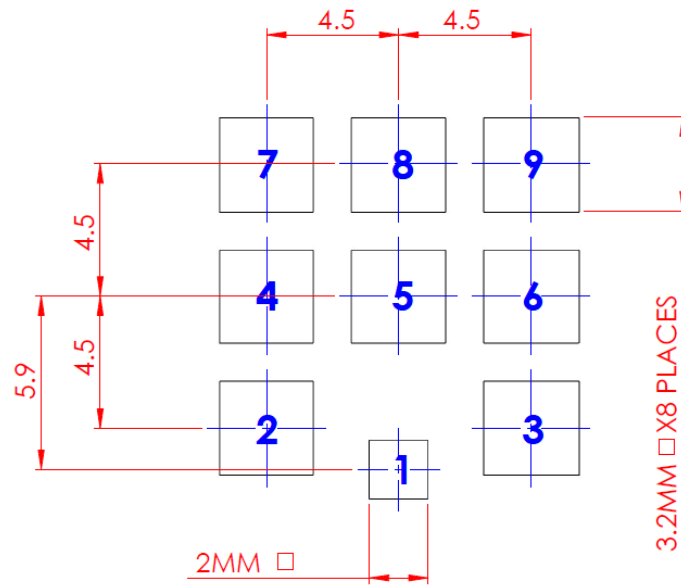

PCB FOOTPRINT

## 6.6 Solder Paste

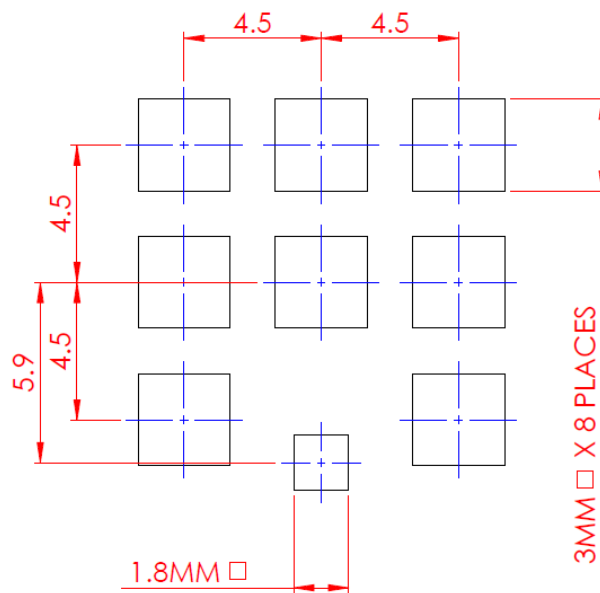

Solder Paste

## 7. Solder Reflow Profile

The SWLP.2450.12.4.B.02 can be assembled by following the recommended soldering temperatures are as follows:

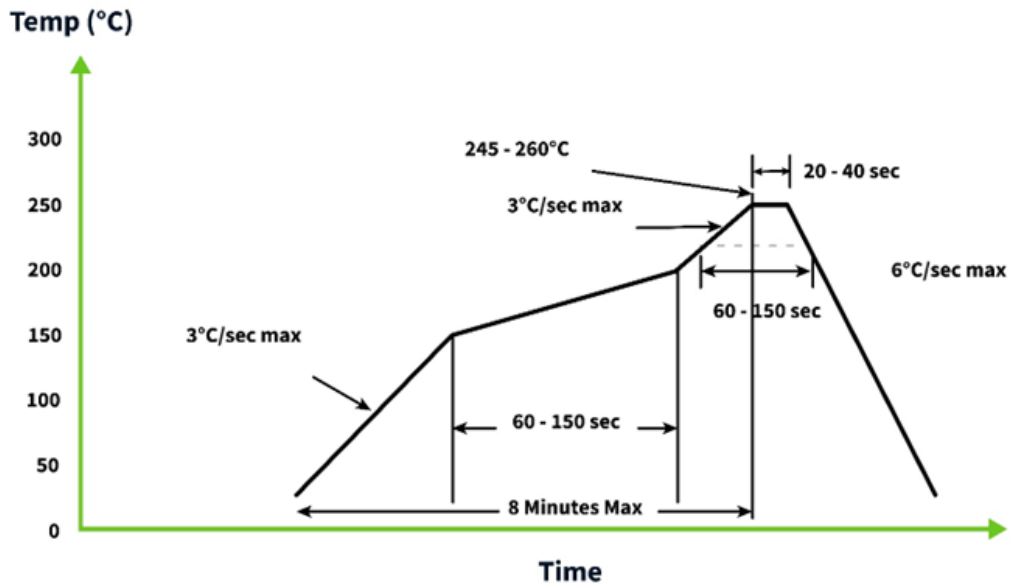

\*Temperatures listed within a tolerance of +/- 10° C

Smaller components are typically mounted on the first pass, however, we do advise mounting the SWLP.2450.12.4.B.02 when placing larger components on the board during subsequent reflows.

## 8. Packaging

500pcs SWLP.2450.12.4.B.02 per Tape & Reel  
 Dimensions - Ø330\*37.4mm

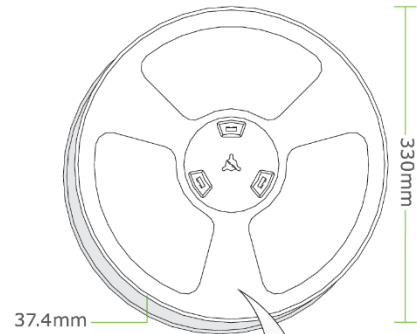

1 Tape and Reel per Small Carton  
 Carton Dimensions - 340\*350\*67mm

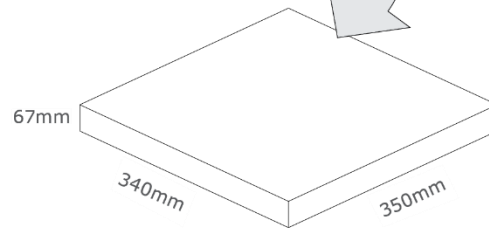

2000pcs per Large Carton  
 Carton Dimensions - 370\*370\*300mm

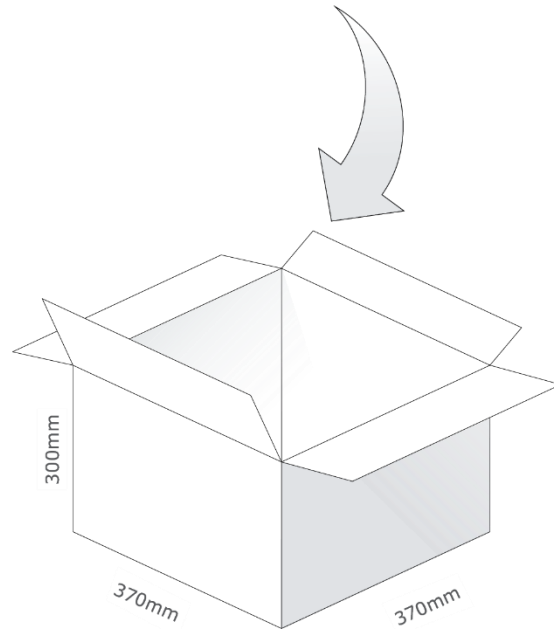

Changelog for the datasheet

**SPE-13-8-007 – SWLP.2450.12.4.B.02**

<b>Revision: M (Current Version)</b>	
Date:	2023-10-13
Changes:	Full datasheet Update
Changes Made by:	Gary West

**Previous Revisions**

<b>Revision: L</b>	
Date:	2023-03-16
Changes:	Antenna Integration Guide
Changes Made by:	Cesar Sousa

<b>Revision: G</b>	
Date:	2017-03-24
Changes:	Updated as per PCN-17-8-005
Changes Made by:	Andy Mahoney

<b>Revision: K</b>	
Date:	2022-02-28
Changes:	Updated Specifications
Changes Made by:	Paul Doyle

<b>Revision: F</b>	
Date:	2016-01-18
Changes:	Amended drawing
Changes Made by:	Aine Doyle

<b>Revision: J</b>	
Date:	2019-11-25
Changes:	Updated graphs with new data
Changes Made by:	Jack Conroy

<b>Revision: E</b>	
Date:	2015-01-15
Changes:	Added note on gain
Changes Made by:	Aine Doyle

<b>Revision: I</b>	
Date:	2019-02-26
Changes:	
Changes Made by:	Jack Conroy

<b>Revision: D</b>	
Date:	2014-10-17
Changes:	Updated drawings
Changes Made by:	Aine Doyle

<b>Revision: H</b>	
Date:	2017-07-05
Changes:	Updated as per PCN 054
Changes Made by:	Andy Mahoney

<b>Revision: C</b>	
Date:	2014-09-22
Changes:	Updated footprint
Changes Made by:	Aine Doyle

<b>Revision: B</b>	
Date:	2014-03-27
Changes:	Amended Eval Board drawing
Changes Made by:	Aine Doyle

<b>Revision: A (First Release)</b>	
Date:	2013-01-13
Changes:	
Changes Made by:	Author

