

# EXLA1V07

## Automotive high current molded inductor



### Product features

- High current carrying capacity
- AEC-Q200 qualified
- Low DCR, high efficiency
- Magnetically shielded, low EMI
- Soft saturation
- Inductance range from 1  $\mu$ H to 10  $\mu$ H
- Current range from 5.0 A to 31.8 A
- EXLA1V0703: 8.7 mm x 8.3 mm footprint surface mount package in a 3.1 mm height
- EXLA1V0705: 8.7 mm x 8.3 mm footprint surface mount package in a 5.0 mm height
- EXLA1V0707: 8.7 mm x 8.3 mm footprint surface mount package in a 7.0 mm height
- Alloy powder core material
- Moisture Sensitivity Level (MSL) 1

### Applications

- LED lighting
- Advanced driver assistance systems (ADAS)
- Adaptive cruise control (ACC)
- Collision avoidance
- Infotainment and cluster electronics
- Battery management systems (BMS)
- Electric pumps, motor control and auxiliaries
- Powertrain control module (PCU)/Engine control module (ECM)
- Electronic Control Units (ECU)

### Environmental compliance and general specifications

- Operating temperature range: -55 °C to +155 °C (ambient plus self-temperature rise)
- Storage temperature range (component): -55 °C to +155 °C
- Solder reflow temperature: J-STD-020 (latest revision) compliant



**Product specifications**

Part number <sup>4</sup>	OCL <sup>1</sup> ( $\mu$ H) $\pm$ 20%	I <sub>rms</sub> <sup>2</sup> (A)	I <sub>sat</sub> <sup>3</sup> (A)	DCR (m $\Omega$ ) typical @ +25 °C	DCR (m $\Omega$ ) maximum @ +25 °C	D (mm) $\pm$ 0.3
<b>EXLA1V0703</b>						
EXLA1V0703-1R0-R	1.0	21.8	28	4.55	5.0	6.6
EXLA1V0703-1R5-R	1.5	15.3	23.5	7.5	8.25	6.6
EXLA1V0703-2R2-R	2.2	13	17	12.4	13.7	6.2
EXLA1V0703-2R7-R	2.7	11.4	13.5	14	15.4	6.2
EXLA1V0703-3R3-R	3.3	10	13	16.3	18	6.2
EXLA1V0703-4R7-R	4.7	9.0	12.2	24.2	26.7	6.2
EXLA1V0703-5R6-R	5.6	7.3	11.5	30.1	33.2	6.2
EXLA1V0703-6R8-R	6.8	6.8	11	38.6	42.5	6.2
EXLA1V0703-8R2-R	8.2	5.9	9.0	44.3	48.73	6.2
EXLA1V0703-100-R	10	5.0	7.0	51	56.1	6.2
<b>EXLA1V0705</b>						
EXLA1V0705-2R2-R	2.2	14	17	5.8	6.4	
EXLA1V0705-3R3-R	3.3	13	14	10.4	11.44	
EXLA1V0705-4R7-R	4.7	11	13	14	15.4	
EXLA1V0705-5R6-R	5.6	10	11	15.6	17.2	
<b>EXLA1V0707</b>						
EXLA1V0707-1R0-R	1.0	25	31.8	2.55	2.81	6.7
EXLA1V0707-1R5-R	1.5	22	25.8	3.75	4.13	6.7
EXLA1V0707-1R8-R	1.8	21	23	4.05	4.46	6.7
EXLA1V0707-2R2-R	2.2	17.8	17.6	5.73	6.33	6.7
EXLA1V0707-3R3-R	3.3	15.1	15.1	8.56	9.42	6.7
EXLA1V0707-4R7-R	4.7	13.6	14	12.2	13.5	6.7
EXLA1V0707-5R6-R	5.6	11.4	12	13.67	15.03	6.5
EXLA1V0707-6R8-R	6.8	9.5	11	17.8	19.6	6.5
EXLA1V0707-100-R	10	7.0	9.0	24	26.4	6.5

1. Open circuit inductance (OCL) test parameters: 100 kHz, 0.1 V<sub>ac</sub>, 0.0 Adc, +25 °C

2. I<sub>rms</sub>: Heat rated current (I<sub>rms</sub>) will cause the part temperature rise approximately  $\Delta$ T of 40 °C. Circuit design, component, PCB trace size and thickness, airflow and other cooling provisions all affect the part temperature. Part temperature should be verified in the end application. The part temperature (ambient + temp rise) should not exceed +155 °C under worst case operating conditions.

3. I<sub>sat</sub>: Peak current for approximately 30% rolloff @ +25 °C

4. Part number definition: EXLA1V0703-xxx-R

EXLA1V0703 = Product code and size

xxx= inductance value in  $\mu$ H, R= decimal point,

If no R is present then third digit equals the number of zeros

-R suffix = RoHS compliant

Note: Rated operating voltage (across inductor) 40 V ref.

**Mechanical parameters, schematic, pad layout (mm)**

**EXLA1V0703**

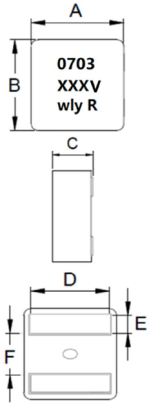

**EXLA1V0705**

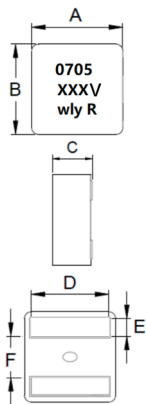

**EXLA1V0707**

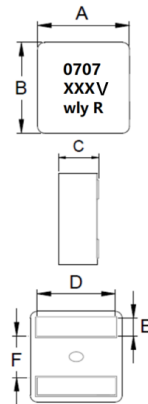

**Recommended pad layout**

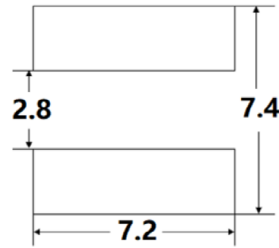

**Schematic**

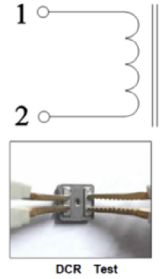

Part number	A	B	C	D	E	F
EXLA1V0703-xxx-R	8.4 ± 0.30	8.0 ± 0.30	2.9 ± 0.20	See spec table	1.75 ± 0.20	3.15 ± 0.25
EXLA1V0705-xxx-R	8.4 ± 0.30	8.0 ± 0.30	4.8 ± 0.20	6.2 ± 0.30	1.75 ± 0.20	3.15 ± 0.25
EXLA1V0707-xxx-R	8.4 ± 0.30	8.0 ± 0.30	6.7 ± 0.30	See spec table	1.75 ± 0.20	3.15 ± 0.25

Part marking: 0703 or 0705 or 0707

xxx= Inductance value in  $\mu\text{H}$  (R= decimal point, if no R is present last digit equals number of zeros, V= vehicle, wly R= lot code)

All soldering surfaces to be coplanar within 0.1 millimeters

Tolerances are  $\pm 0.3$  millimeters unless stated otherwise

Dimensions of recommended PCB layout are reference only.

Pad layout tolerances are  $\pm 0.1$  millimeters unless stated otherwise

Traces or vias underneath the inductor is not recommended.

**Packaging information (mm)**

Supplied in tape and reel packaging

EXLA1V0703: 1500 parts per 13" diameter reel (EIA-481 compliant)

EXLA1V0705: 800 parts per 13" diameter reel (EIA-481 compliant)

EXLA1V0707: 750 parts per 13" diameter reel (EIA-481 compliant)

Drawing not to scale

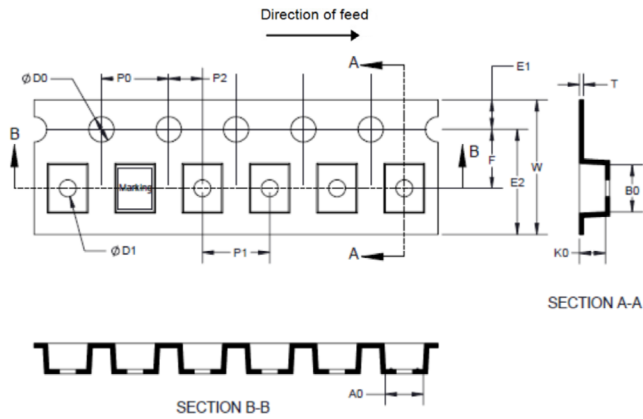

	EXLA1V0703	EXLA1V0705	EXLA1V0707
$W \pm 0.30$	16.00	16.00	16.00
$F \pm 0.10$	7.50	7.50	7.50
$E1 \pm 0.10$	1.75	1.75	1.75
E2	14.25	14.25	14.25
$P0 \pm 0.10$	4.00	4.00	4.00
$P1 \pm 0.10$	12.00	12.00	12.00
$P2 \pm 0.10$	2.00	2.00	2.00
$D0 + 0.10/-0$	1.50	1.50	1.50
$D1 + 0.10/-0$	1.50	1.50	1.50
$A0 \pm 0.10$	8.80	8.80	8.80
$B0 \pm 0.10$	8.40	8.40	8.40
$K0 \pm 0.10$	3.30	5.30	7.30
$T \pm 0.05$	0.35	0.40	0.50
$P0 \times 10 \pm 0.20$	40.0	40.0	40.0

**Inductance and temperature rise vs. current**  
**EXLA1V0703**

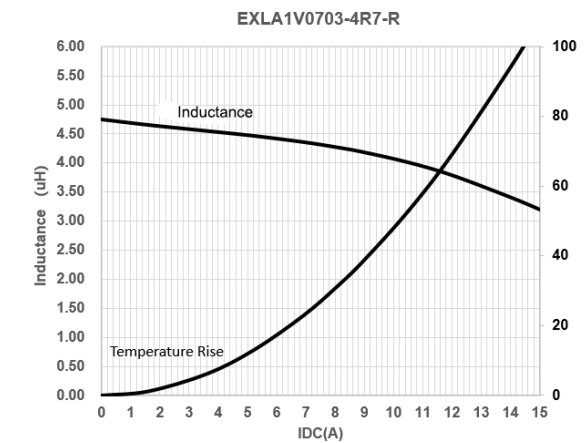
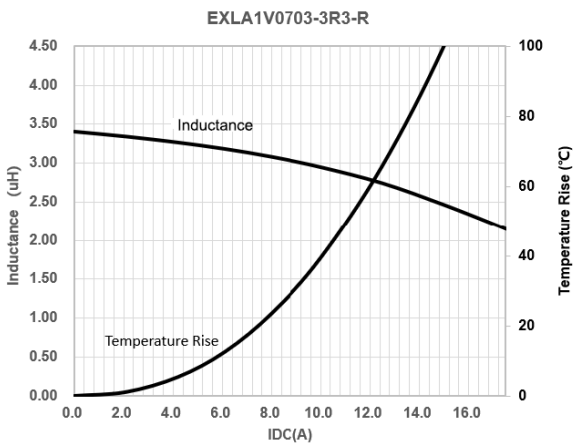
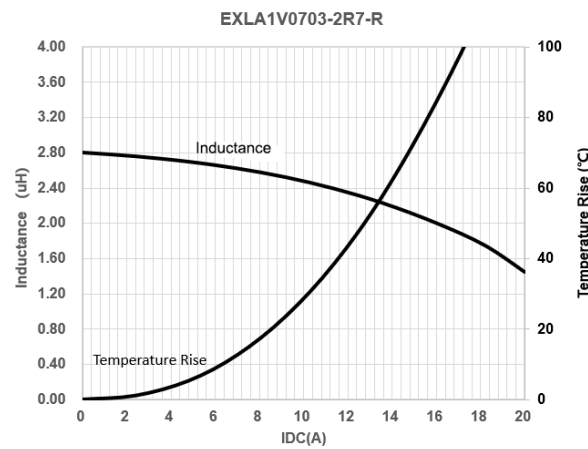
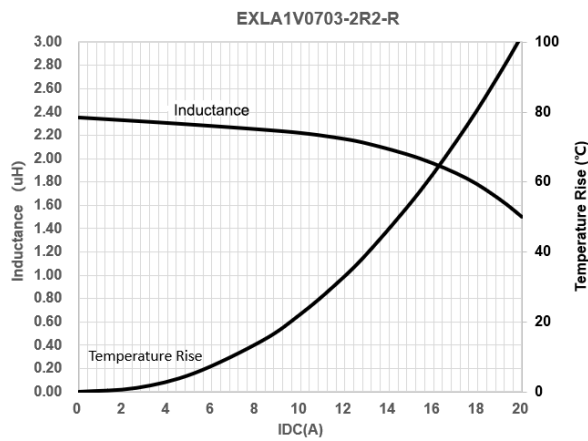
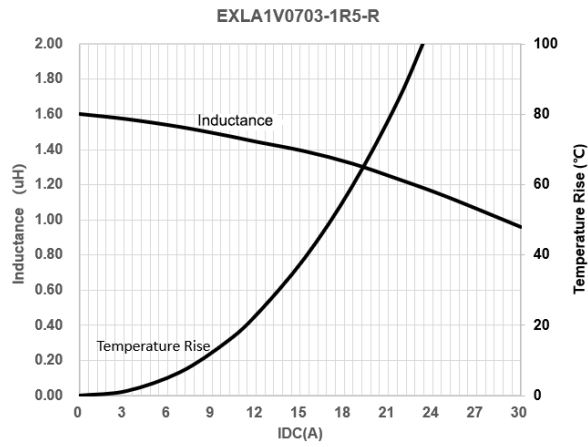
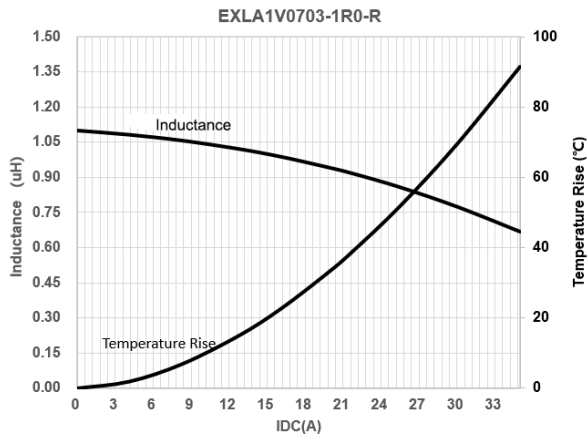

**Inductance and temperature rise vs. current, continued**  
**EXLA1V0703**

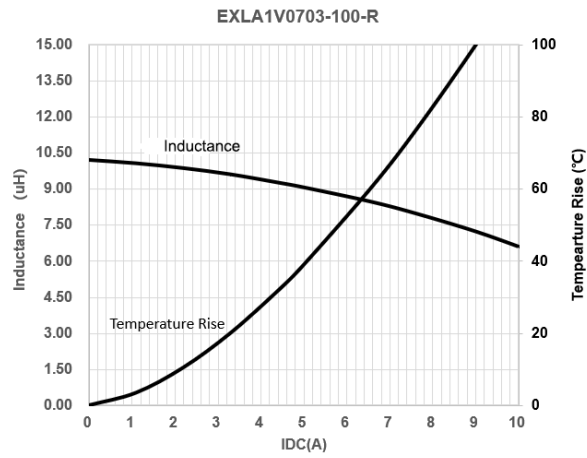
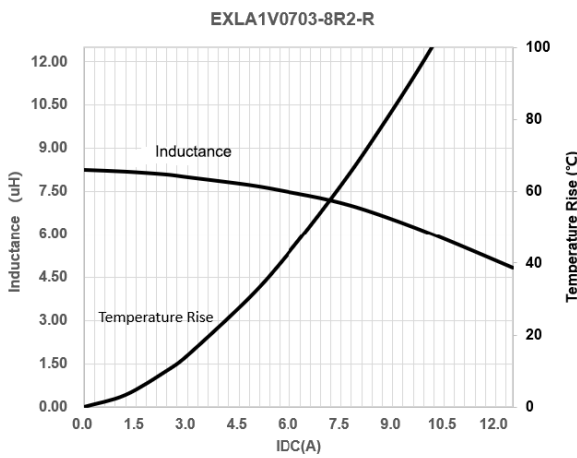
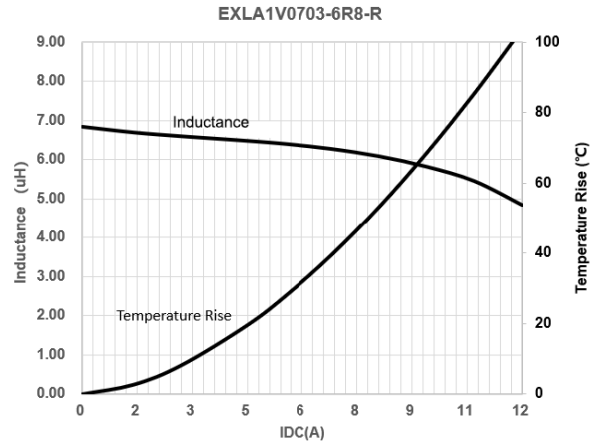
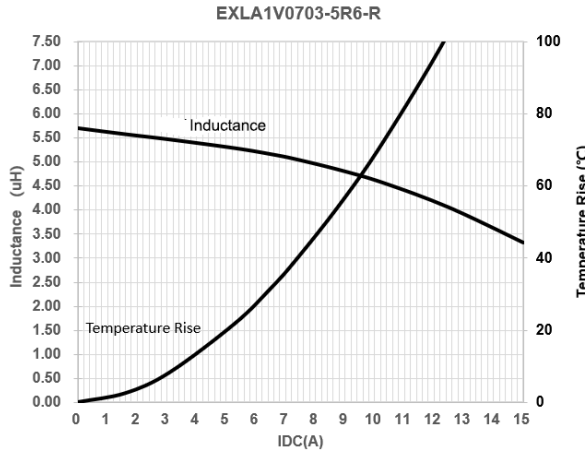

**Inductance and temperature rise vs. current**  
**EXLA1V0705**

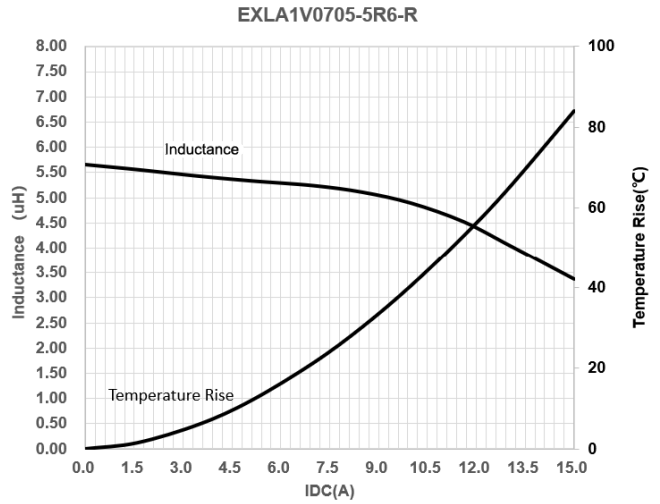
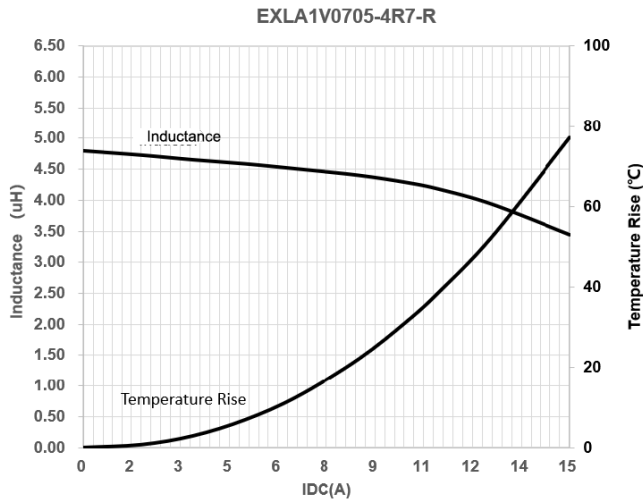
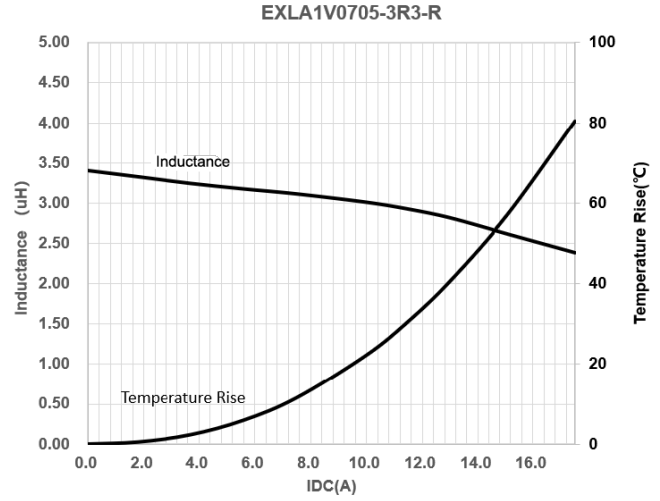
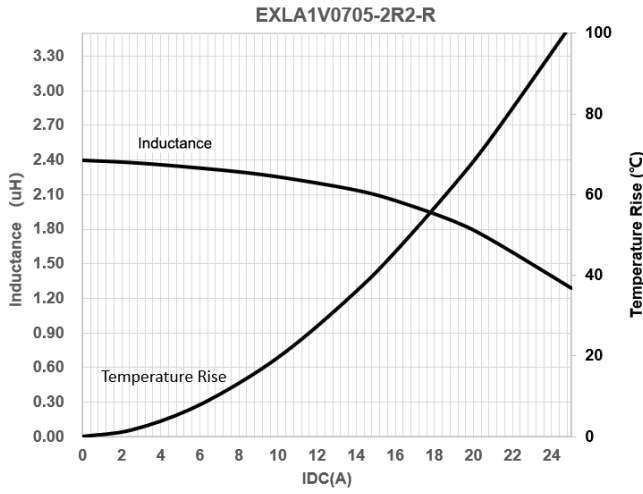

**Inductance and temperature rise vs. current**  
**EXLA1V0707**

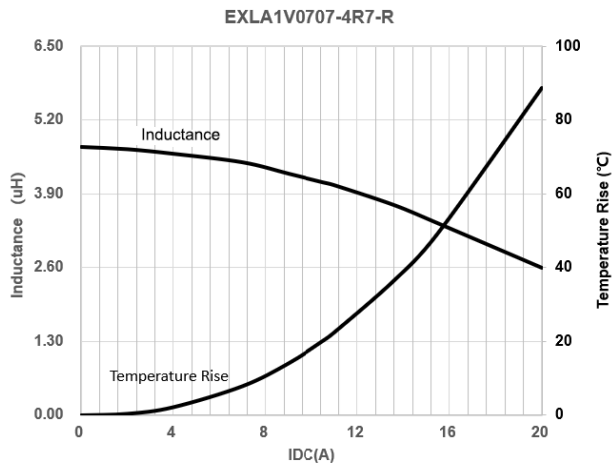
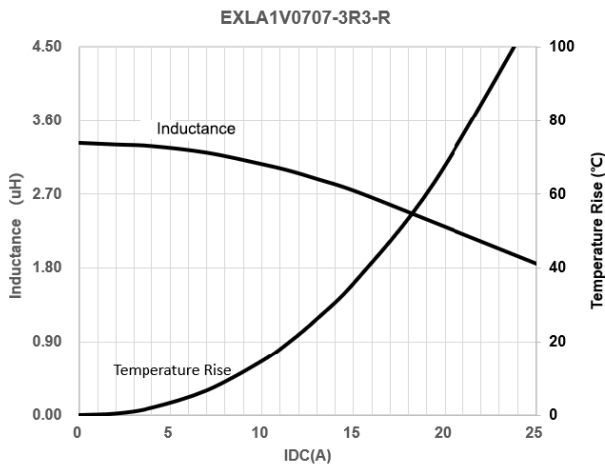
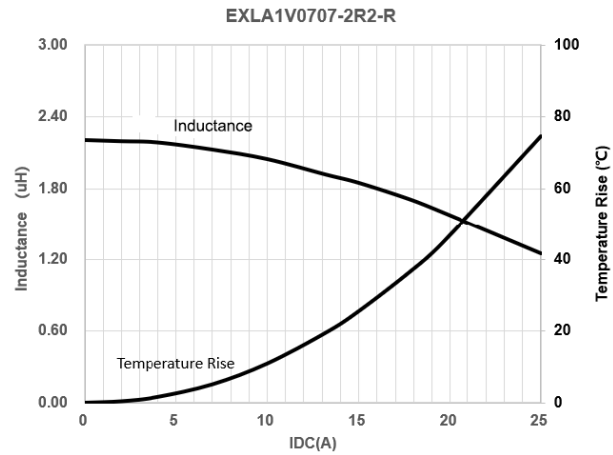
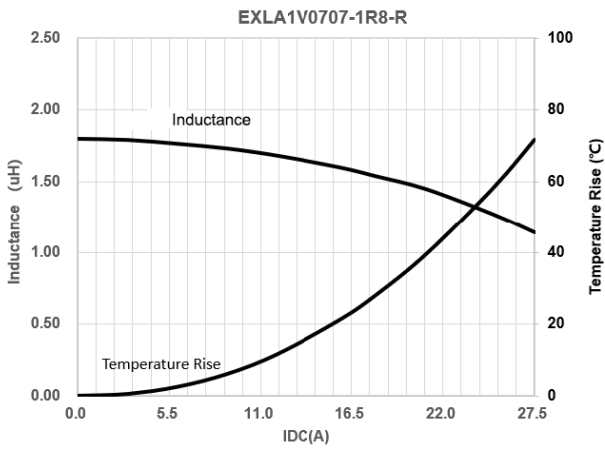
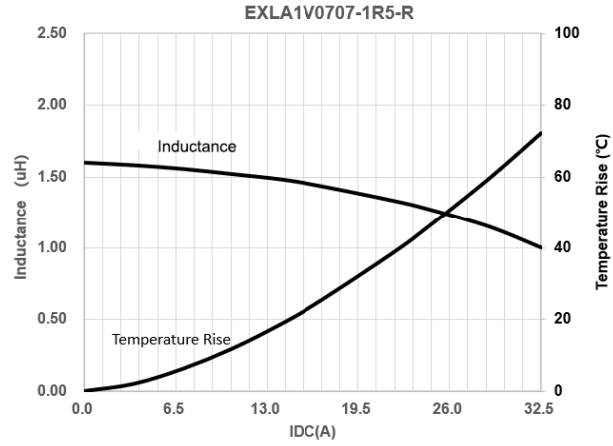
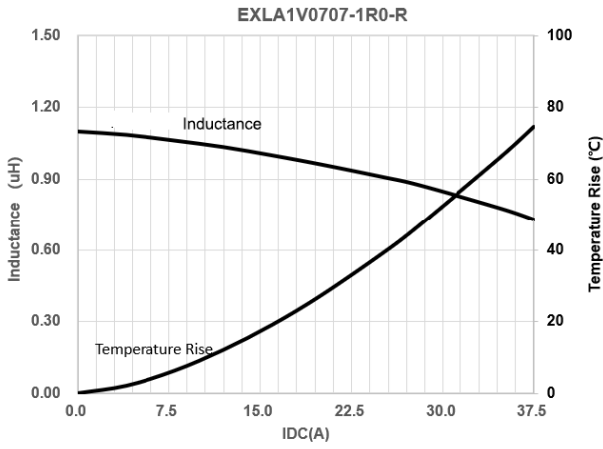



Inductance and temperature rise vs. current, continued  
EXLA1V0707

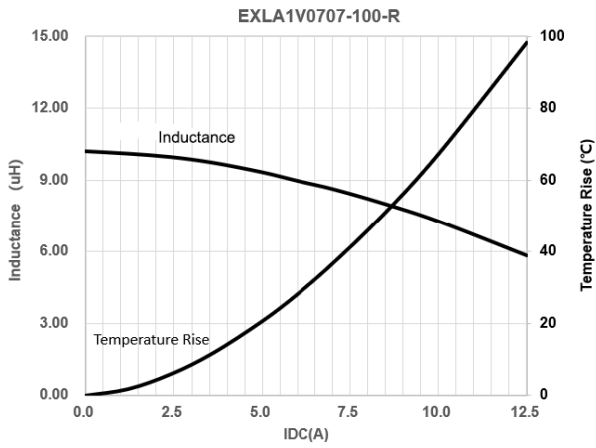
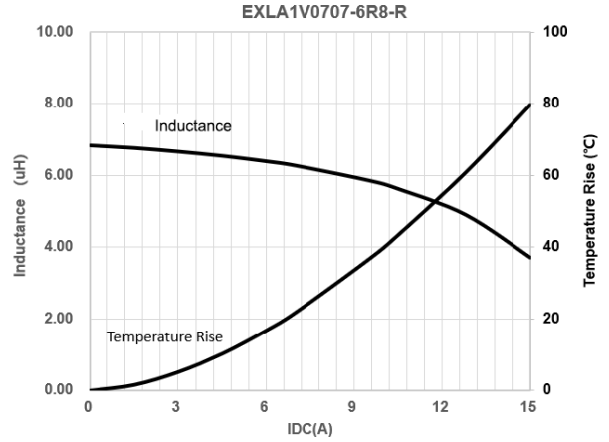
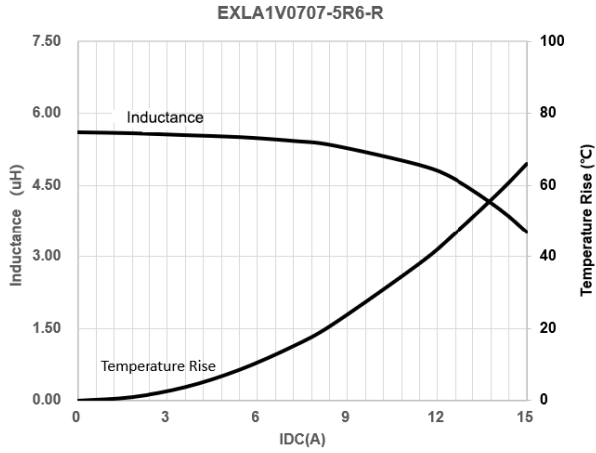

**Inductance and impedance vs frequency curve**  
**EXLA1V0703**

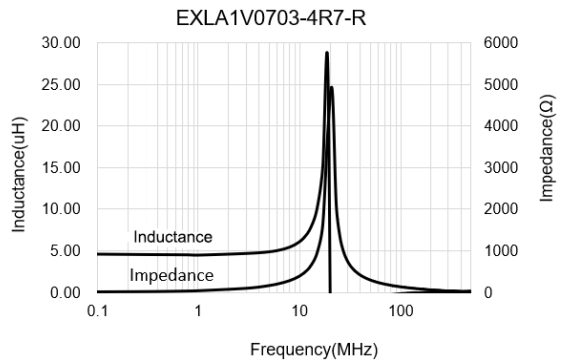
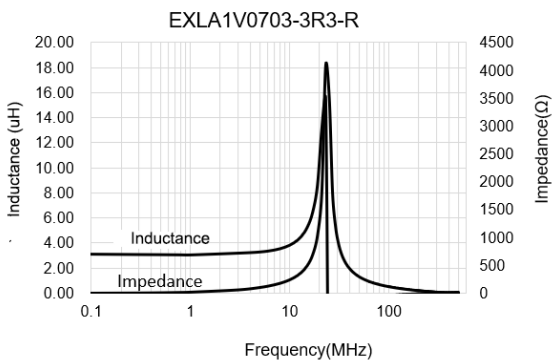
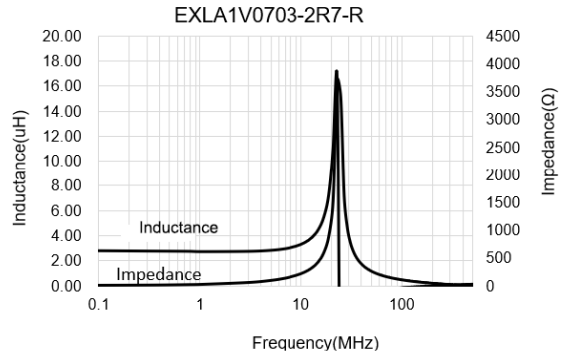
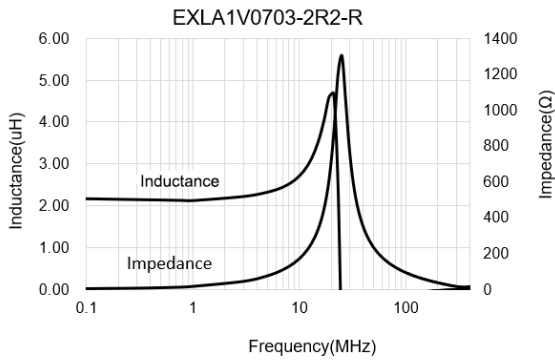
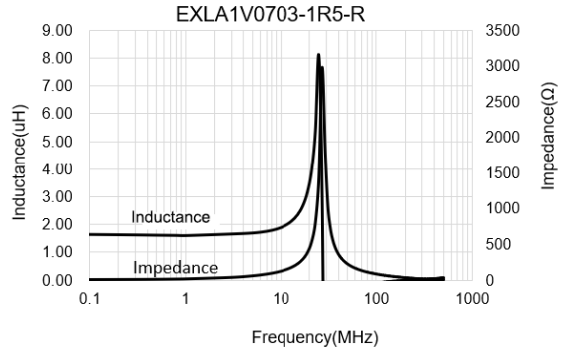
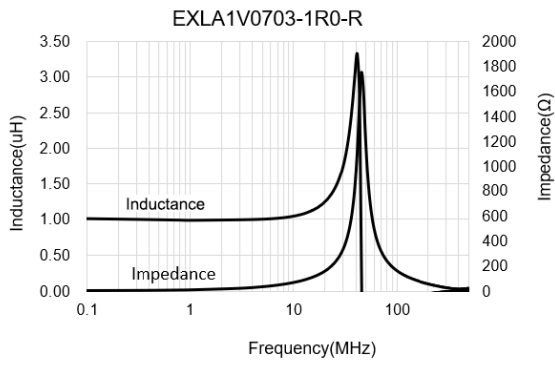

Inductance and impedance vs frequency curve, continued  
EXLA1V0703

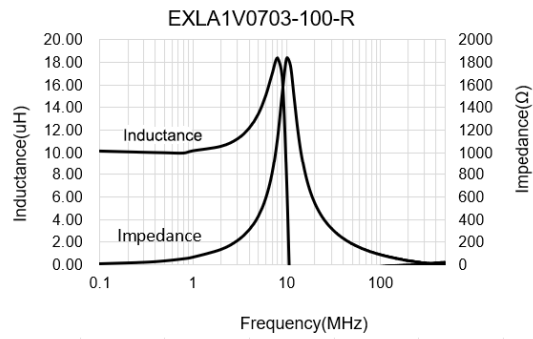
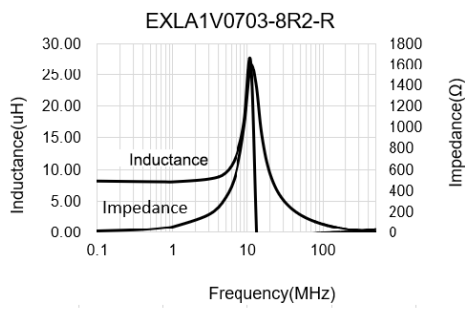
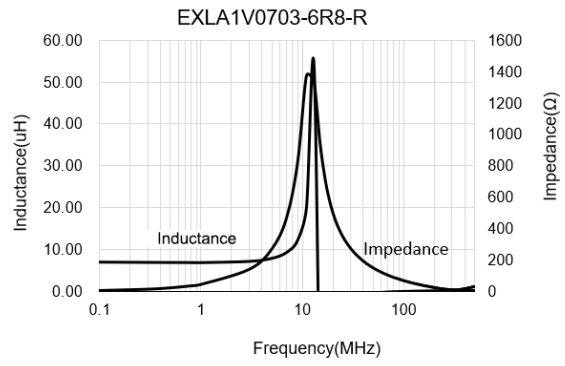
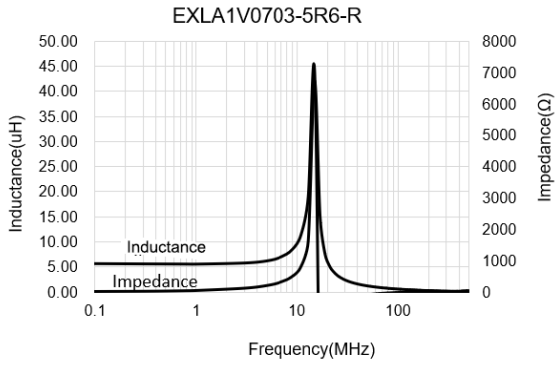

Inductance and impedance vs frequency curve

EXLA1V0705

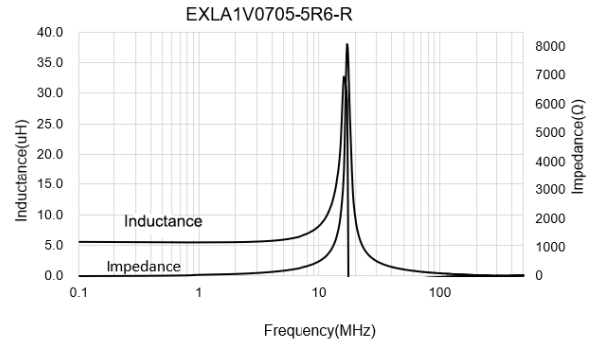
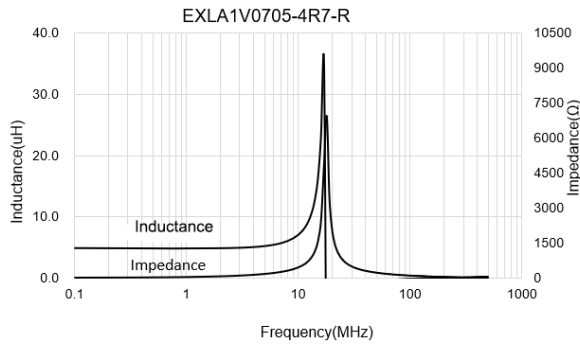
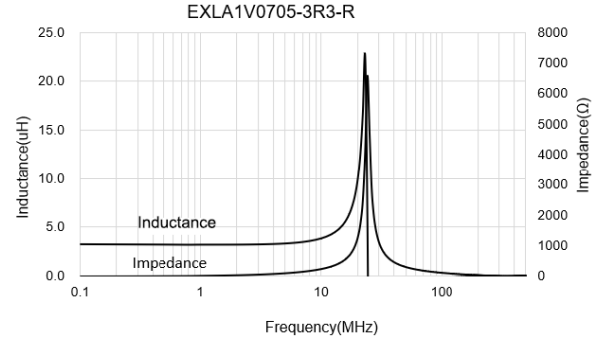
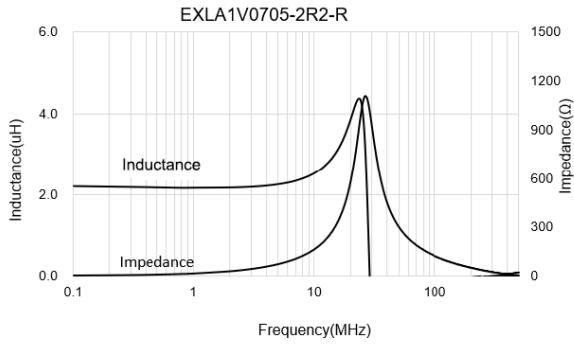

Inductance and impedance vs frequency curve

EXLA1V0707

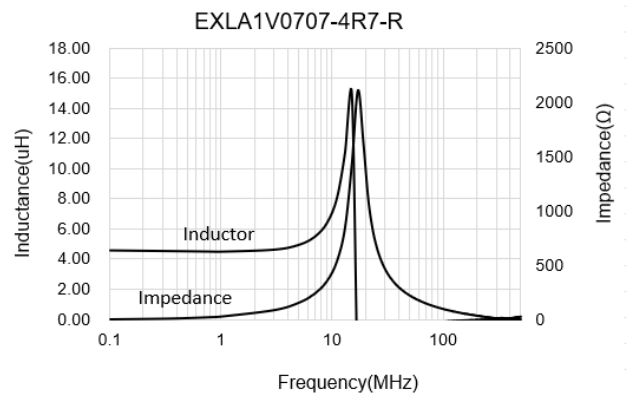
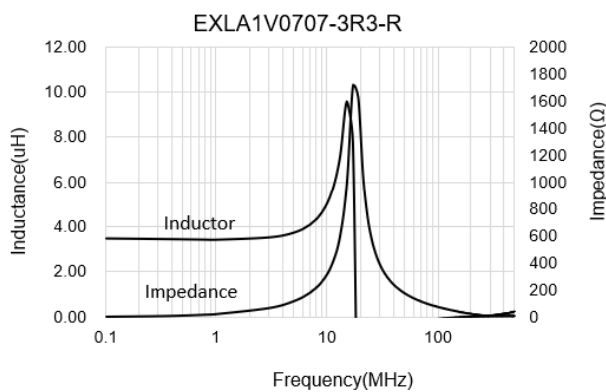
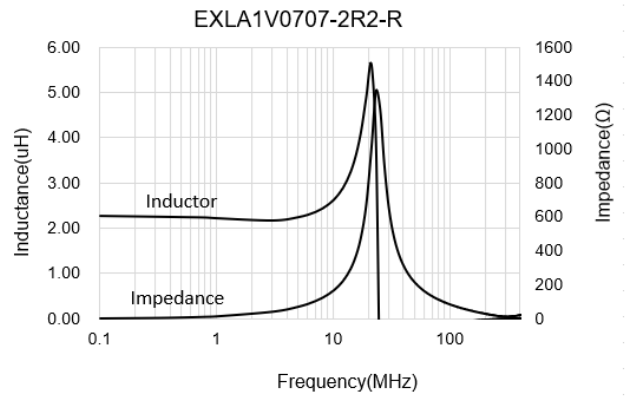
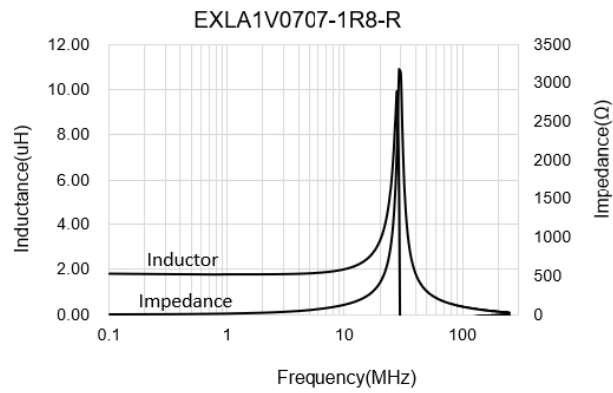
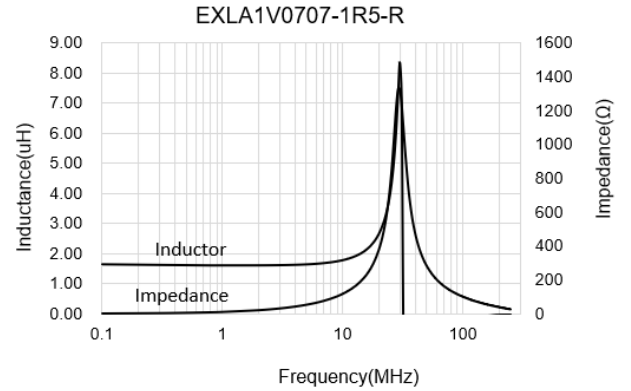
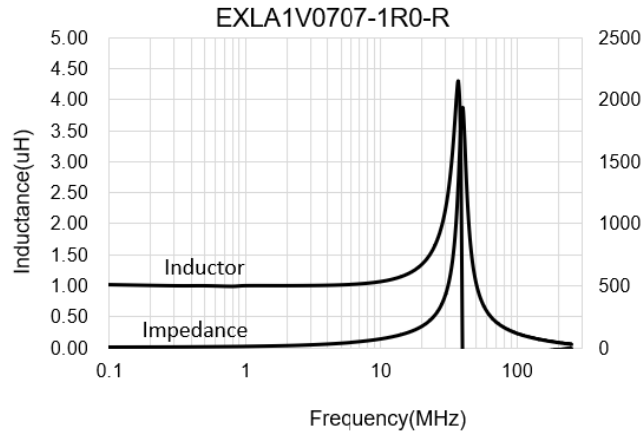

**Inductance and impedance vs frequency curve**

**EXLA1V0707**

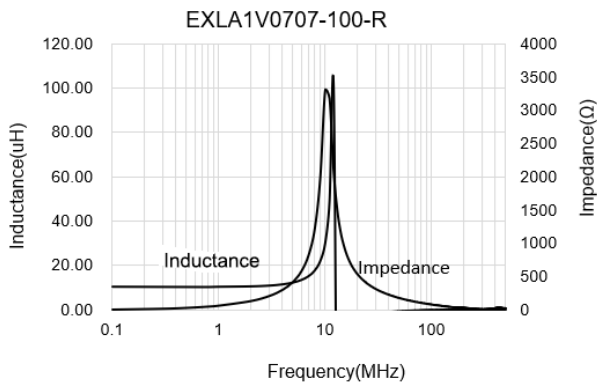
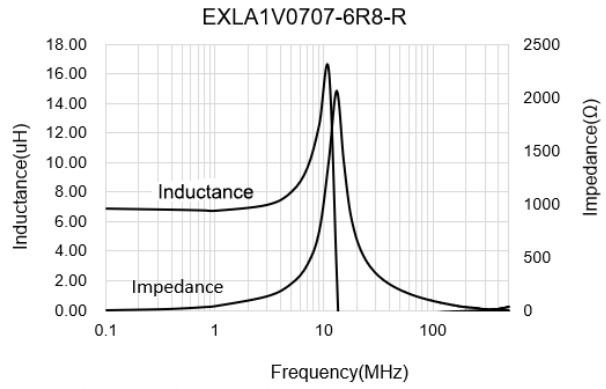
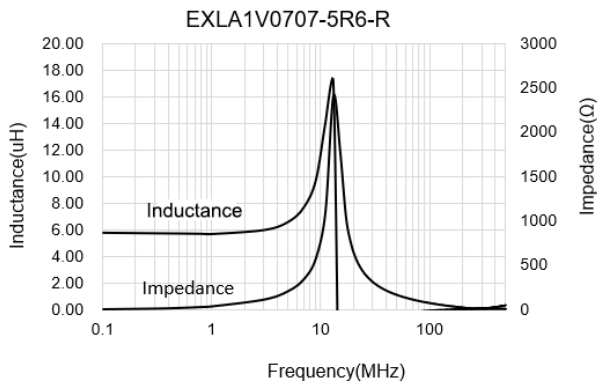

Solder reflow profile

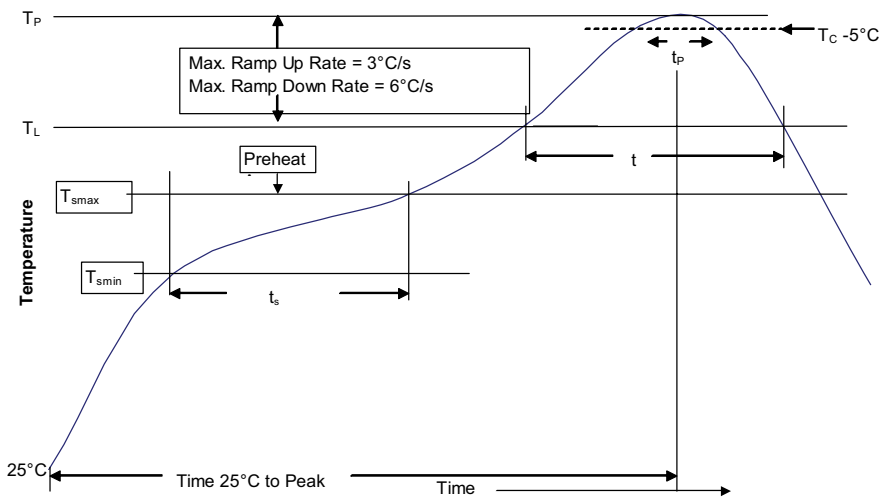

Table 1 - Standard SnPb solder (T<sub>C</sub>)

Package thickness	Volume mm <sup>3</sup> <350	Volume mm <sup>3</sup> ≥350
<2.5 mm	235 °C	220 °C
≥2.5 mm	220 °C	220 °C

Table 2 - Lead (Pb) free solder (T<sub>C</sub>)

Package thickness	Volume mm <sup>3</sup> <350	Volume mm <sup>3</sup> 350 - 2000	Volume mm <sup>3</sup> >2000
<1.6 mm	260 °C	260 °C	260 °C
1.6 – 2.5 mm	260 °C	250 °C	245 °C
>2.5 mm	250 °C	245 °C	245 °C

Reference J-STD-020

Profile feature	Standard SnPb solder	Lead (Pb) free solder
Preheat and soak		
• Temperature min. (T <sub>smin</sub> )	100 °C	150 °C
• Temperature max. (T <sub>smax</sub> )	150 °C	200 °C
• Time (T <sub>smin</sub> to T <sub>smax</sub> ) (t <sub>s</sub> )	60-120 seconds	60-120 seconds
Ramp up rate T <sub>L</sub> to T <sub>p</sub>	3 °C/ second max.	3 °C/ second max.
Liquidous temperature (T <sub>L</sub> )	183 °C	217 °C
Time (t <sub>L</sub> ) maintained above T <sub>L</sub>	60-150 seconds	60-150 seconds
Peak package body temperature (T <sub>p</sub> )*	Table 1	Table 2
Time (t <sub>p</sub> )* within 5 °C of the specified classification temperature (T <sub>C</sub> )	20 seconds*	30 seconds*
Ramp-down rate (T <sub>p</sub> to T <sub>L</sub> )	6 °C/ second max.	6 °C/ second max.
Time 25 °C to peak temperature	6 minutes max.	8 minutes max.

\* Tolerance for peak profile temperature (T<sub>p</sub>) is defined as a supplier minimum and a user maximum.

Life Support Policy: Eaton does not authorize the use of any of its products for use in life support devices or systems without the express written approval of an officer of the Company. Life support systems are devices which support or sustain life, and whose failure to perform, when properly used in accordance with instructions for use provided in the labeling, can be reasonably expected to result in significant injury to the user.

Eaton reserves the right, without notice, to change design or construction of any products and to discontinue or limit distribution of any products. Eaton also reserves the right to change or update, without notice, any technical information contained in this bulletin.

**Eaton**  
Electronics Division  
1000 Eaton Boulevard  
Cleveland, OH 44122  
United States  
Eaton.com/electronics

© 2022 Eaton  
All Rights Reserved  
Printed in USA  
Publication No. ELX1222 BU-ELX22082  
July 2022

Eaton is a registered trademark.

All other trademarks are property of their respective owners.

Follow us on social media to get the latest product and support information.

