

Product Summary

$V_{(BR)DSS}$	$R_{DS(on)TYP}$	I_D
150V	3mΩ@10V	260A

Feature

- Fast Switching
- Low Gate Charge and Rds(on)
- 100% Single Pulse avalanche energy Test

Applications

- Power switching application
- DC-DC Converter
- Power Management

Package

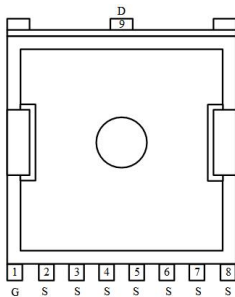

Toll

Circuit diagram

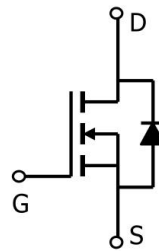

Marking

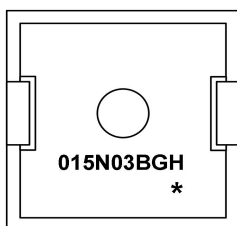

015N03BGH : Product code
* : Month code

Absolute maximum ratings (Ta=25°C, unless otherwise noted)

Parameter	Symbol	Rating	Unit
Drain source voltage	V_{DS}	150	V
Gate source voltage	V_{GS}	± 20	V
Continuous drain current(Tc=25°C)	I_D	260	A
Pulsed drain current	I_{DM}	1040	A
Power dissipation(Tc=25°C)	P_D	320	W
Single pulsed avalanche energy ¹⁾	E_{AS}	1863	mJ
Thermal resistance, junction-case	$R_{\theta JC}$	0.39	°C/W
Operation and storage temperature	T_{stg}, T_j	-55 to 150	°C

Electrical characteristics (Ta=25°C, unless otherwise noted)

Characteristics	Symbol	Test Condition	Min	Typ	Max	Unit
Static Characteristics						
Drain-Source Breakdown Voltage	BV_{DSS}	$I_D = 250\mu A, V_{GS} = 0V$	150	-	-	V
Drain Cut-Off Current	I_{DSS}	$V_{DS} = 120V, V_{GS} = 0V$	-	-	1	μA
Gate Leakage Current	I_{GSS}	$V_{GS} = \pm 20V, V_{DS} = 0V$	-	-	± 0.1	
Gate Threshold Voltage	$V_{GS(th)}$	$V_{DS} = V_{GS}, I_D = 250\mu A$	2.5	3.0	3.5	V
Drain-Source ON Resistance	$R_{DS(ON)}$	$V_{GS} = 10V, I_D = 20A$	-	3	3.8	m Ω
Dynamic Characteristics						
Input Capacitance	C_{iss}	$V_{DS} = 75V, V_{GS} = 0V, f = 1.0MHz$	-	10560	-	pF
Output Capacitance	C_{oss}		-	1306	-	
Reverse Transfer Capacitance	C_{rss}		-	48	-	
Switching Characteristics						
Total Gate Charge	Q_g	$V_{DS} = 75V, V_{GS} = 10V, I_D = 70A$	-	160	-	nC
Gate-Source Charge	Q_{gs}		-	66	-	
Gate-Drain Charge	Q_{gd}		-	42	-	
Turn-On Delay Time	$t_{d(on)}$	$V_{GS} = 10V, V_{DS} = 75V, R_L = 3\Omega, R_G = 4.7\Omega$	-	34	-	ns
Rise Time	t_r		-	27	-	
Turn-Off Delay Time	$t_{d(off)}$		-	78	-	
Fall Time	t_f		-	30	-	
Drain-Source Body Diode Characteristics						
Source-Drain Diode Forward Voltage	V_{SD}	$I_S = 1A, V_{GS} = 0V$	-	-	1.2	V

Note:

- E_{AS} is tested at starting $T_j = 25^\circ C, V_{DD} = 75V, V_{GS} = 10V, L = 0.5mH, R_g = 25\Omega$;

Typical Characteristics

Typical Electrical and Thermal Characteristics

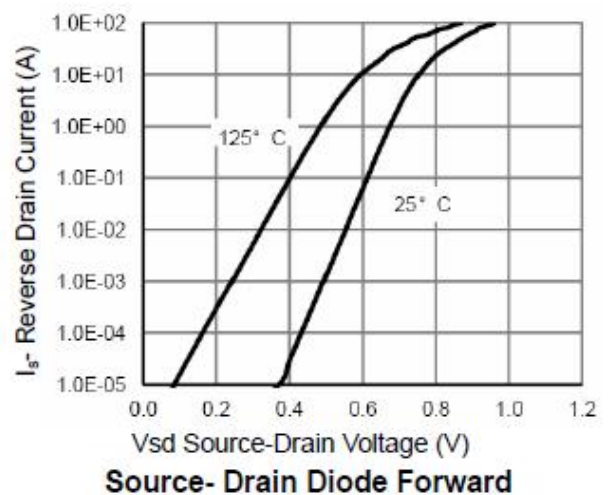
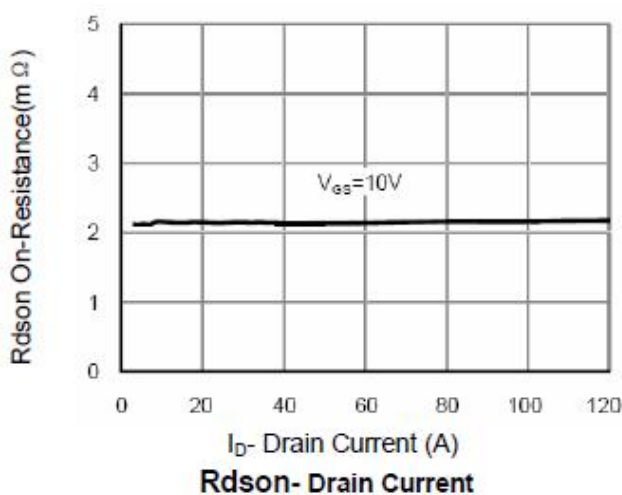
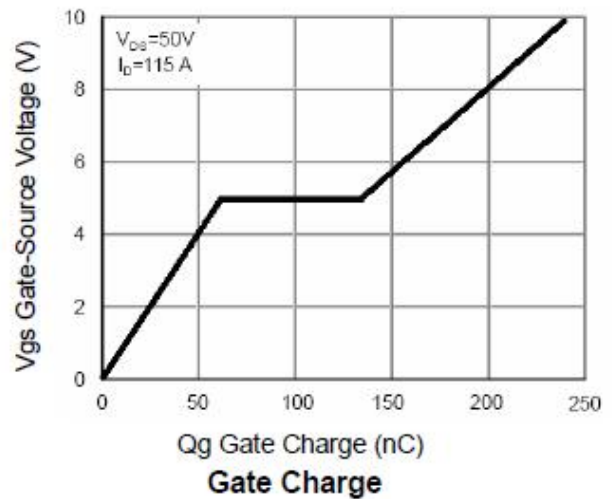
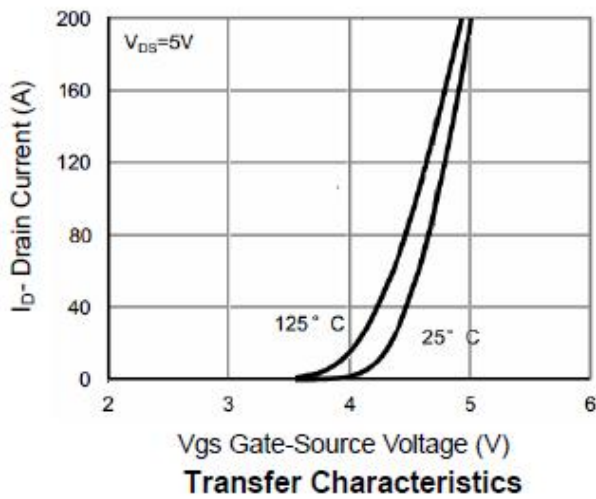
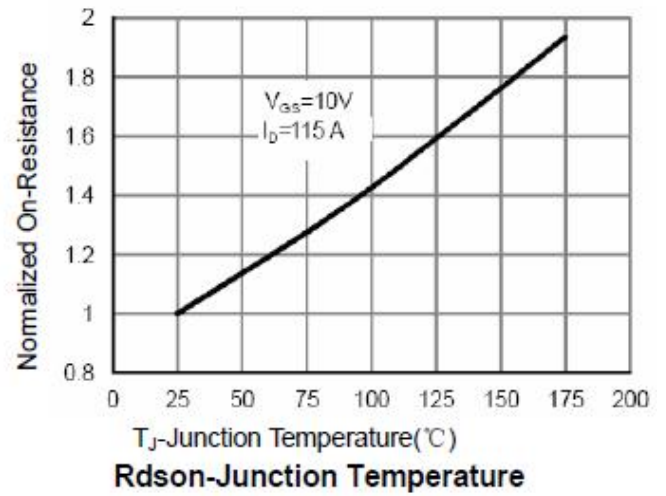
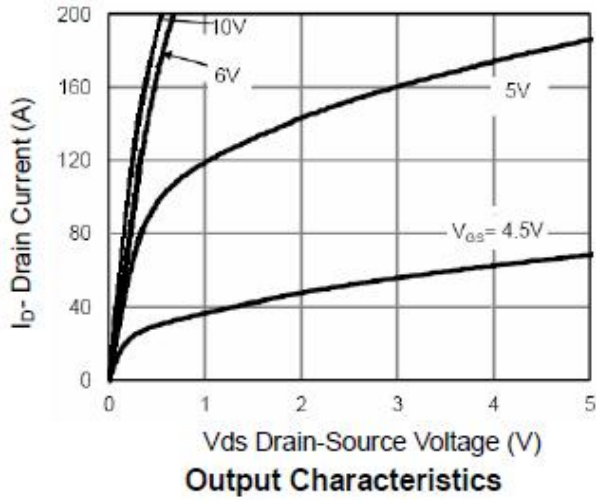

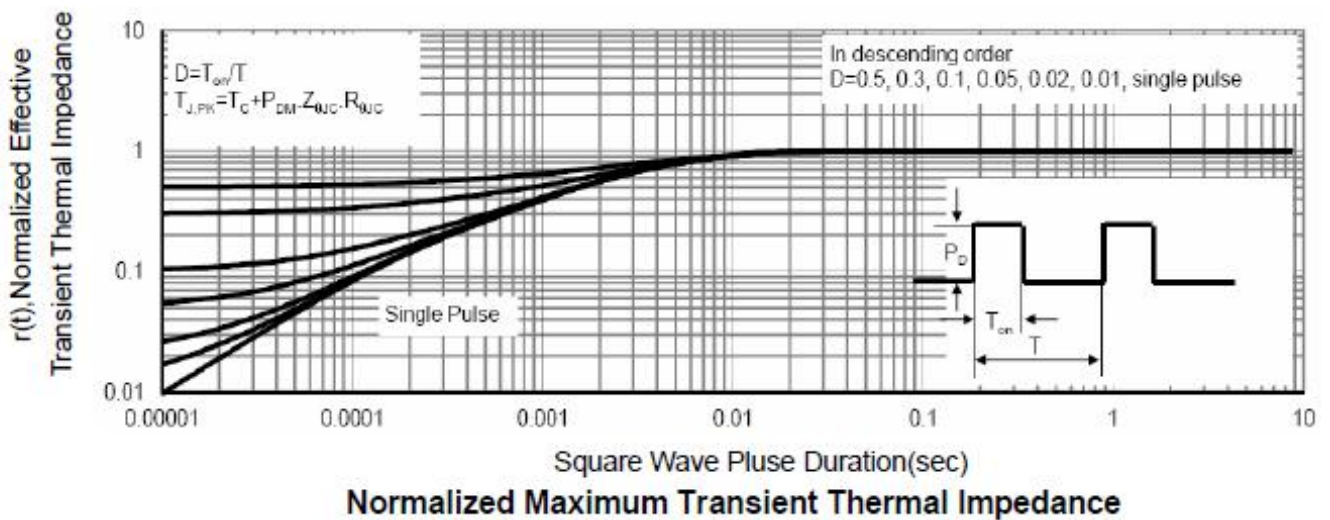
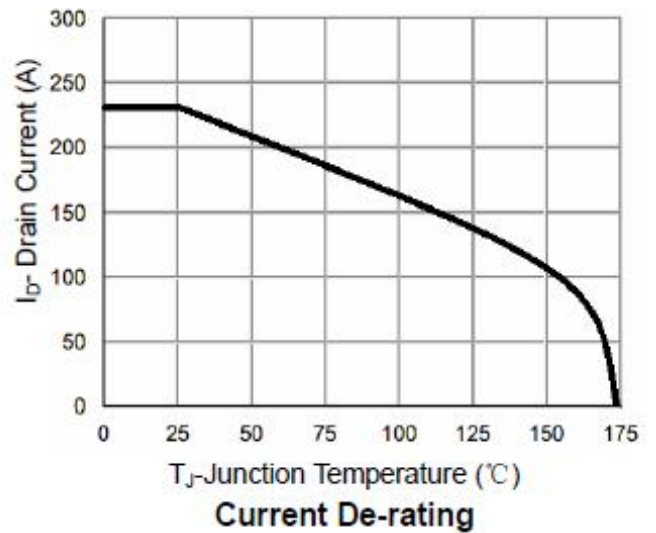
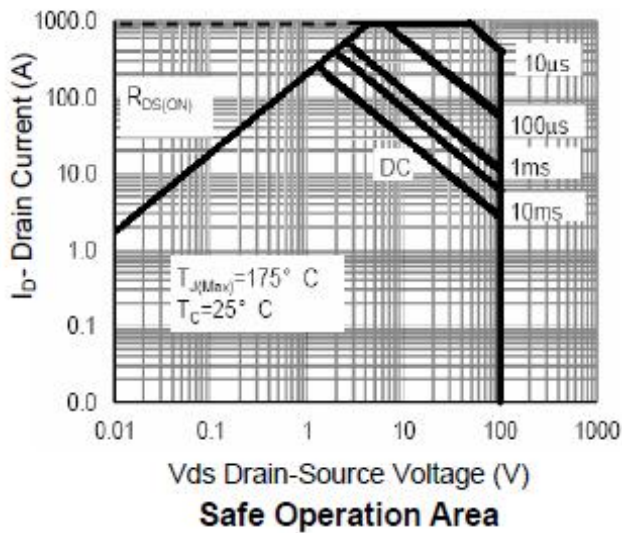
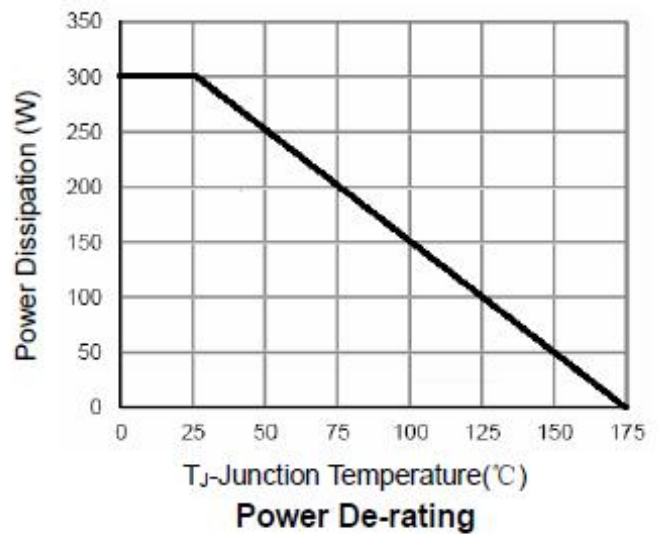
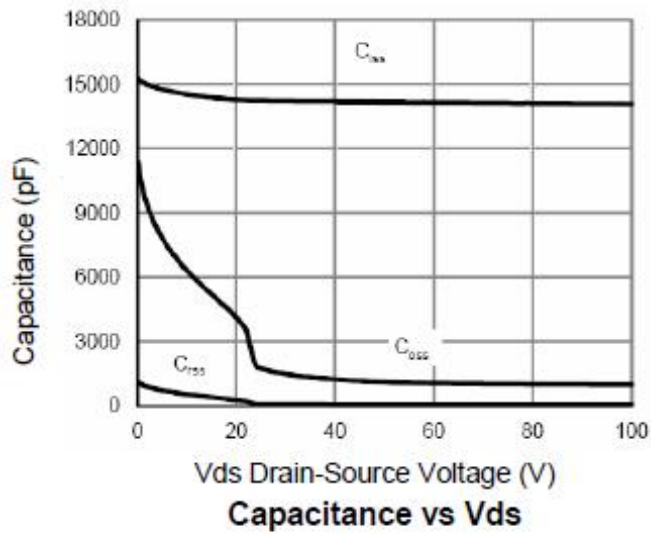

TOLL Package Information

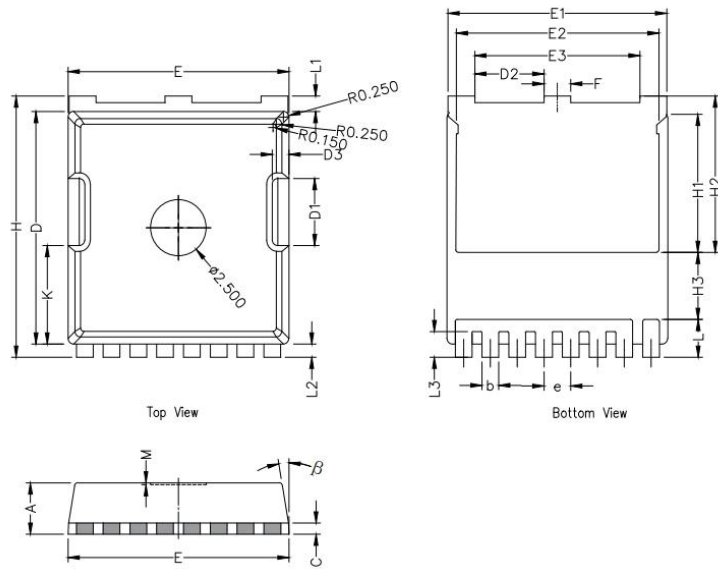

Symbol	Dimensions In Millimeters		
	Min.	Nom.	Max.
A	2.20	2.30	2.40
b	0.65	0.75	0.85
C	0.508 REF		
D	10.25	10.40	10.55
D1	2.85	3.00	3.15
E	9.75	9.90	10.05
E1	9.65	9.80	9.95
E2	8.95	9.10	9.25
E3	7.25	7.40	7.55
e	1.20 BSC		
F	1.05	1.20	1.35
H	11.55	11.70	11.85
H1	6.03	6.18	6.33
H2	6.85	7.00	7.15
H3	3.00 BSC		
L	1.55	1.70	1.85
L1	0.55	0.7	0.85
L2	0.45	0.6	0.75
M	0.08 REF.		
β	8°	10°	12°
K	4.25	4.40	4.55