

Output Voltage (V)	Output Current (A)	Input Voltage (V)
12	50	36-75

FEATURES

- DOSA Compliant Digital Quarter-Brick with PMBus interface
- 36-75Vin Range
- 96% Typical Efficiency
- Delivers up to 50A (600W)
- Low Output Ripple & Noise
- Wide Operating Temperature Range -40°C to +85°C
- Optional Droop Load Sharing of two or more modules
- Baseplate included for improved thermal performance
- Output Over Current/Voltage Protection
- Over Temperature Protection
- Negative & Positive Logic (Negative Logic standard configuration)
- Optional Reflow process compatible
- Three pin/function configurations available:
 - Full PMBus with Sense & Trim Pins
 - No PMBus with Sense & Trim Pins
 - 5 Pin Bus converter, No Sense & Trim Pins
- Certified to UL 62368-1, CAN/CSA-C22.2 No.62368-1-14, 2nd Ed, 2014-12-01; IEC62368-1:2014 (Second Edition); standards
- Basic I/O insulation now available. Refer to Note [3] on following page for applicable model information

Applications

- Distributed Power Architectures
- Intermediate Bus Voltage Applications
- Networking Equipment including POE applications
- Servers & Storage Applications
- Fan Tray assemblies along with other applications requiring a regulated Voltage source

PRODUCT OVERVIEW

Murata Power Solutions is introducing the first in a series of DOSA compliant, digitally controlled DC-DC converters that are based on a 32-bit ARM processor. The DSQ series provides a fully regulated, digitally controlled DC output in a ¼-brick format that will support the DOSA industry standard footprint for isolated board mounted power modules. The DSQ series supports advances in power conversion technology including a digital interface supporting the PMBus protocol for communications to power modules. The DSQ0150V2 is an isolated, regulated, 600W-12Vout quarter brick that supports the TNV (Telecommunications Network Voltage) input voltage range of 36V–75V with a typical efficiency of 96%. The DSQ series

also incorporates a “droop” load sharing option that allows connecting two or more units together in parallel for demanding power-hungry applications or to provide redundancy in high reliability applications. The converter also offers high input to output of 2250 VDC as required for Power over Ethernet (PoE) applications. The DSQ series is suitable for applications covering MicroTCA, servers and storage applications, networking equipment, Telecommunications equipment, Power over Ethernet (PoE), fan trays, wireless networks, wireless pre-amplifiers, and industrial and test equipment, along with other applications requiring a regulated 12V.

DSQ

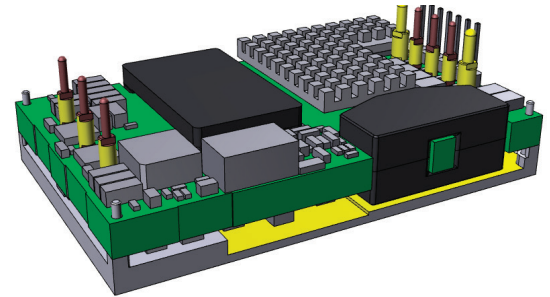

DAQ

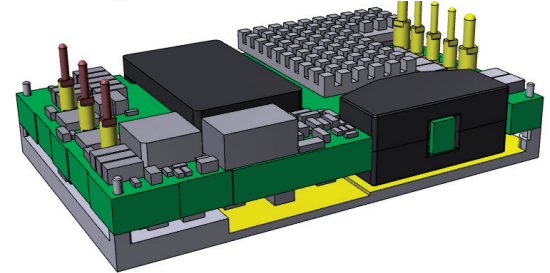

DCQ

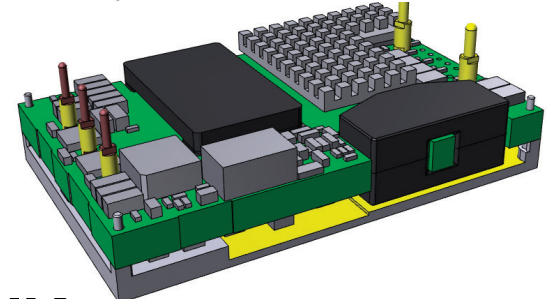

PERFORMANCE SPECIFICATIONS SUMMARY AND ORDERING GUIDE [1]

Root Model	Output						Input			Efficiency
	V _{OUT} (V)	I _{OUT} (A, max.)	Total Power (W)	Ripple & Noise (mVp-p)	Regulation (Typ.)		V _{IN} (V, Nom.)	Range (V)	I _{IN} , full load@V _{INmin} (A)	Typ.
					Line (mV)	Load (mV)				
DSQ0150V2	12	50	600	120	75	45	48	36-75	17.5	96.00%
DAQ0150V2	12	50	600	120	75	45	48	36-75	17.5	96.00%
DCQ0150V2	12	50	600	120	75	45	48	36-75	17.5	96.00%

Notes:

[1] Typical at TA = +25°C under nominal line voltage and full-load conditions. All models are specified with an external 1µF multi-layer ceramic and 10µF capacitors across their output pins.

Part Number Structure*

Product Family[1]	D	S																			DS = DOSA Standard Digital Quarter Brick W/Sense & Trim, 1 W/PMbus DA = DOSA Analog Quarter Brick W/Sense & Trim, No PMbus DC = DOSA Analog Quarter Brick (5 pin IBC)
Form Factor			Q																		Q = Quarter Brick
Vout				01																	01 = 12Vout , 02 = 5Vout , 03 = 3.3Vout
Output Current					50																Max Iout in Amps
Vin Range						V2															V2 = 36-75Vin
Logic							N														N = Negative Logic, P = Positive Logic
Pin Length[2]								X													1 = 0.110"(2.79 mm), 2 = 0.145"(3.68mm), Omit for standard pin length(shown in the mechanical drawings)
Mechanical Configuration									B												B = Baseplate
Load Sharing										S											S = Load Sharing, Omit for standard
Reflow Compliant[2]											R										R = MSL-3 Compliant Packaging, Omit for Standard through hole processing
Specific Customer Configuration												X	X	X							Customer Code, Omit for Standard
RoHS 6/6																					C RoHS 6/6 Compliant

*See www.murata.com/power/products for model-specific availability.

Example Part Number DSQ0150V2N2BRSC DOSA Digital Quarter Brick, 12Vout@50A, Negative logic, 0.145" pin length, Baseplate, Reflow/MSL-3 compliant, Load Sharing, RoHS 6/6.

[1] Load Sharing on DSQ (with PMbus) will not include Sense & Trim pins. Loading Sharing is not available on DAQ.

[2] Minimum order quantity is required. Samples available with standard pin length only.

[3] Basic I/O insulation available on DSQ0150V2NBSCAPD (PMBus 1/4tr brick, 12Vout @ 50A, 36-75Vin, Negative Logic, Baseplate, Load Share, RoHS, Basic I/O insulation)

FUNCTIONAL SPECIFICATIONS

ABSOLUTE MAXIMUM RATINGS	Conditions [1]	Minimum	Typical/Nominal	Maximum	Units
Input Voltage, Continuous		0		75	Vdc
Input Voltage, Transient	100 ms max. duration			100	Vdc
Voltage	Input to output			2250	Vdc
On/Off Remote Control	Power on, referred to -Vin	0		13.5	Vdc
Output Power		0		612	W
Output Current	Current-limited, no damage, short-circuit protected	0		50	A
Storage Temperature Range	Vin = Zero (no power)	-55		125	°C
Absolute maximums are stress ratings. Exposure of devices to greater than any of these conditions may adversely affect long-term reliability. Proper operation under conditions other than those listed in the Performance/Functional Specifications Table is not implied nor recommended.					
General Conditions for Device under Test unless otherwise specified: Typical at ambient temperature +25°C, nominal line voltage and nominal load conditions; All models are specified with an external 220µF input capacitor and 1µF & 10µF capacitors across their output pins.					
INPUT					
Operating voltage range (V2)		36	48	75	Vdc
Start-up threshold	(Default, configurable via PMBus)	32	34	36	Vdc
Undervoltage shutdown	(Default, configurable via PMBus)	30	32	34	Vdc
Internal Filter Type			Pi		
External Input fuse			30		A
Input current					
Full Load Conditions	Vin = nominal		13.00	13.50	A
Low Line input current	Vin = minimum		17.50	18.00	A
Inrush Transient	Vin = 48V.		0.7	1	A ² -Sec.
Short Circuit input current			0.1	0.2	A
No Load input current	Vin = 48V, Iout = 0, unit=ON		80	110	mA
Shut-Down input current (Off, UV, OT)				30	mA
Back Ripple Current	no filtering		1.5		Ap-p
GENERAL AND SAFETY					
Efficiency	Vin=48V, full load	94.5	96		%
Voltage	Input to output			2250	Vdc
	Input to Baseplate			1500	Vdc
	Output to Baseplate			1500	Vdc
Insulation Safety Rating	Contact the factory for Basic Insulation		Functional		
Resistance			10		MΩ
Capacitance			1500		pF
Safety	Certified to UL62368-1, CAN/CSA-C22.2 No.62368-1-14, 2nd Ed, 2014-12-01; IEC62368-1:2014 (Second Edition)		Yes		
Calculated MTBF	Per Telcordia SR-332, Issue 3, Method 1, Case 1, Ground Fixed		5000		Hours x 10 ³
DYNAMIC CHARACTERISTICS					
Switching Frequency (Configurable via PMBus)					
Fixed Frequency Control			180		kHz
Variable Frequency Control (Default)			NA		kHz
Turn On Time (Configurable via PMBus)					
Vin On to within 10% Vout steady state			80	90	ms
Remote On to within 10% Vout steady state				5	ms
Vout Rise Time (Default, Configurable via PMBus)					
From 10%~90%				30	ms
Dynamic Load Response	50-75-50%, 0.1A/us, within 1% of Vout (Vin=Vinnom, tested with a 1.0 µF ceramic, 10 µF tantalum and 330µF low ESR polymer capacitor across the load.)		200	300	µSec
Dynamic Load Peak Deviation			±250	±350	mV
Dynamic Load Response	50-75-50%, 1A/us, within 1% of Vout (Vin=Vinnom, tested with a 1.0 µF ceramic, 10 µF tantalum and 330µF low ESR polymer capacitor across the load.)		300	750	µSec
Dynamic Load Peak Deviation			±500	±750	mV

FEATURES AND OPTIONS	Conditions	Minimum	Typical/Nominal	Maximum	Units
Remote On/Off Control Click link for additional information in technical notes section					
Primary On/Off control (suitable for driving open collector logic; voltages referenced to -Vin)					
"P" Suffix:					
Positive Logic, ON state	ON = pin open or external voltage	3.5		13.5	V
Positive Logic, OFF state	OFF = ground pin or external voltage	0		0.8	V
Control Current	open collector/drain		0.1	0.2	mA
"N" suffix:					
Negative Logic, ON state	ON = ground pin or external voltage	-0.1		0.8	V
Negative Logic, OFF state	OFF = pin open or external voltage	3.5		13.5	V
Control Current	open collector/drain		0.1	0.2	mA
Remote Sense Compliance	Sense pins connected externally to respective Vout pins			10	%
OUTPUT					
Total Output Power		0	600	612	W
Voltage					
Initial Output Voltage	VIN = 48V Iout = 0A temp = 25C, both with/without "S" suffix	11.98		12.02	Vdc
Output Voltage(without"S" suffix)	" VOUT_DROOP = 0mohm All conditions"	11.76	12	12.24	Vdc
Output Voltage(with"S" suffix)	" VOUT_DROOP = 7mohm All conditions"	(12.000-Iout*0.007)*0.98	12.000-Iout*0.007	(12.000-Iout*0.007)*1.02	Vdc
Output Adjust Range(without"S" suffix)	Hardware TRIM	9.6		13.2	Vdc
Trim Down: Trim (pin #6) to -Vout Sense (pin #5)	Rt down (kΩ) = 5.11/((Vnom-Vo)/Vnom)-10.22	-20			%
Trim Up: Trim (pin #6) to +Vout Sense (pin #7)	"Rt up(kΩ)= 5.11*Vnom*(1+Δ)/(1.225*Δ)-5.11/Δ-10.22 Δ=(Vnom-Vo)/Vnom"			+10	%
Overvoltage Protection	Configurable via PMBus	13.8	14.4	15.6	Vdc
Voltage Droop	Default, configurable via PMBus		0		mΩ
Voltage Droop, for S suffix	Default, configurable via PMBus		7		mΩ
Current					
Output Current Range		0	50	50	A
Minimum Load			No minimum load		
Current Limit Inception	90% of Vnom., after warm-up, Configurable via PMBus(Need check the OCP Inception of Vout is whether reasonable)	56	60	65	A
Short Circuit					
Short Circuit Current	Hiccup technique, autorecovery within 1% of Vout		0.4	1	A
Short Circuit Duration (remove short for recovery)	Output shorted to ground, no damage		Continuous		
Short circuit protection method	Hiccup current limiting		Non-latching		
Regulation					
Line Regulation	Vin = 36-75, Vout = nom., full load			75	mV
Load Regulation(without " S "suffix)	"Iout = min. to max., Vin = nom. Vout@min_load-Vout@max_load "			45	mV
Load Regulation(with" S "suffix)	"Iout = min to max Vin = nom. @cold condition Vout@min_load-Vout@max_load-Iout*VOUT_DROOP "			120	mV
Ripple and Noise	"(Vin=Vinnom and Io=lomin to Iomax, tested with a 1.0 μF ceramic, 10 μF tantalum and 330μF low ESR polymer capacitor across the load.)"		120	150	mV pk-pk
Temperature Coefficient	At all outputs		0.01	0.02	% of Vnom./°C
Maximum Output Capacitance	Low ESR	330		10,000	μF
PMBUS MONITORING ACCURACY					
VIN_READ		-3		3	%
VOUT_READ		-2		2	%
IOUT_READ		-2		2	A
TEMP_READ		-5		5	°C

MECHANICAL	Conditions	Minimum	Typical/Nominal	Maximum	Units
Outline Dimensions			2.3 x 1.45 x 0.52		Inches
			58.4 x 36.80 x 13.21		mm
Weight			2.35		Ounces
			66.8		Grams
Through Hole Pin Diameter			0.04 & 0.062		Inches
			1.016 & 1.575		mm
Digital Interface Pin Diameter			0.02		
Through Hole Pin Material			0.5		
TH Pin Plating Metal and Thickness	Nickel subplate		Copper alloy		
	Gold overplate		98.4-299		μ-inches
			4.7-19.6		μ-inches
ENVIRONMENTAL					
Operating Ambient Temperature Range	with derating	-40		85	°C
Operating Baseplate Temperature		-40		110	°C
Storage Temperature	Vin = Zero (no power)	-55		125	°C
Thermal Protection/Shutdown (with "B" Suffix, default value, Configurable via PMBUS)	Configurable Via PMBus		128		°C
Electromagnetic Interference Conducted, EN55022/CISPR22	External filter required; see emissions performance test.		B		Class
Notes: [1] Typical at TA=+25°C under nominal line voltage and full-load conditions. All models are specified with an external 1μF Multi-layer ceramic and 10μF capacitors across their output pins.					

PERFORMANCE DATA

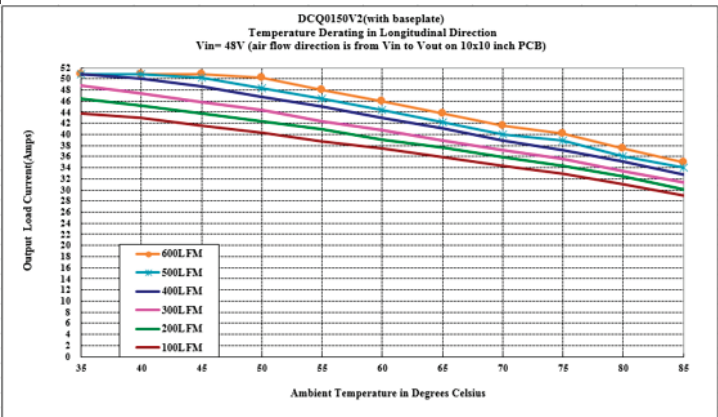
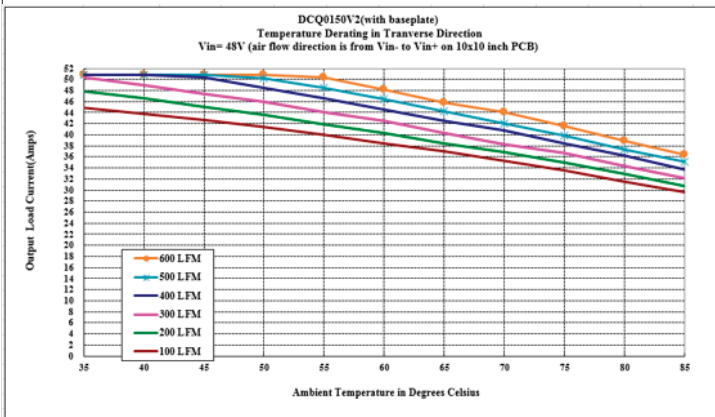
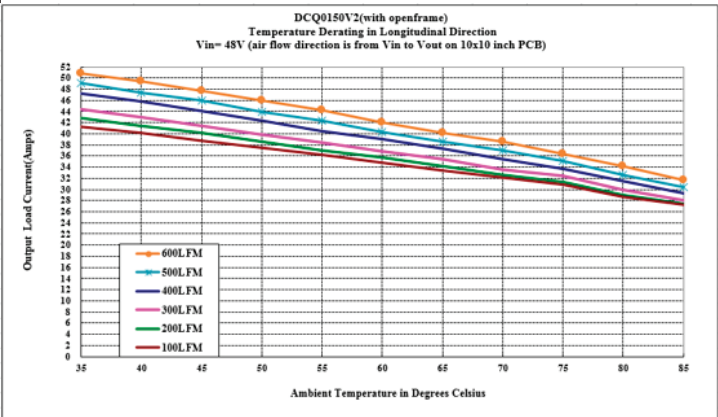
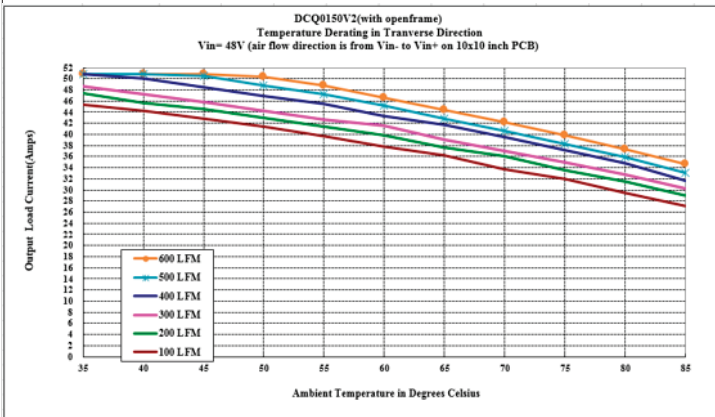
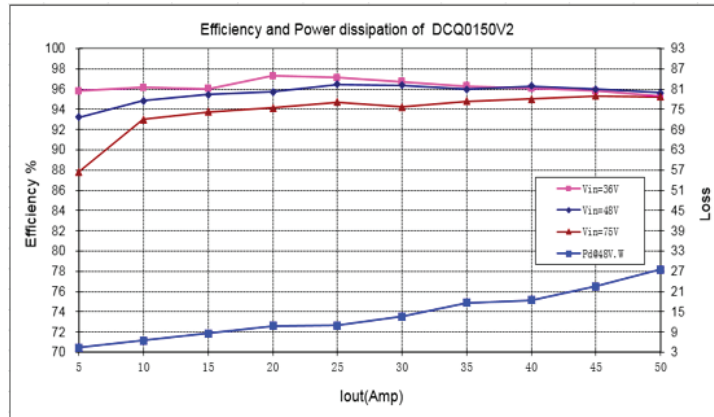

PERFORMANCE DATA

Figure 7. Ripple/Noise @+25°C
(Vin=48V, Iout=0A, Cload=330µF, ScopeBW=20MHz, 2µS/div, 50mV/div)

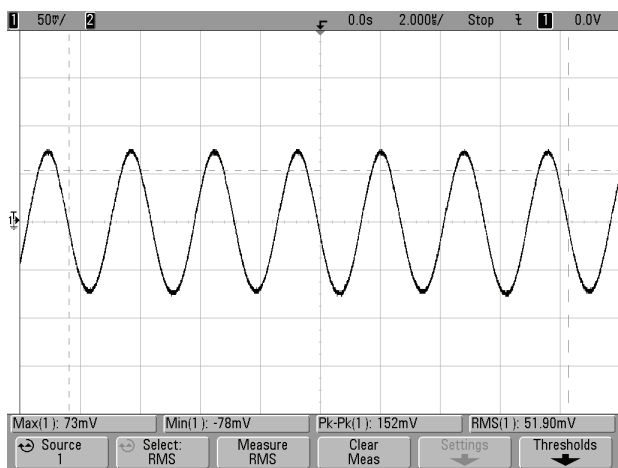

Figure 8. Ripple/Noise @+25°C
(Vin=48V, Iout=50A, Cload=330µF, ScopeBW=20MHz, 2µS/div, 50mV/div)

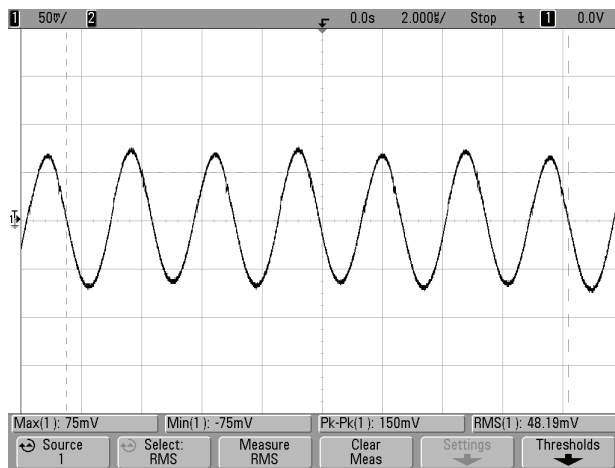

Figure 9. Enable Start-up Delay (CH2: Vout, CH4: On/Off)
(Vin=48V, Iout=0A, Cload=330µF, Ta=+25°C, 5ms/div)

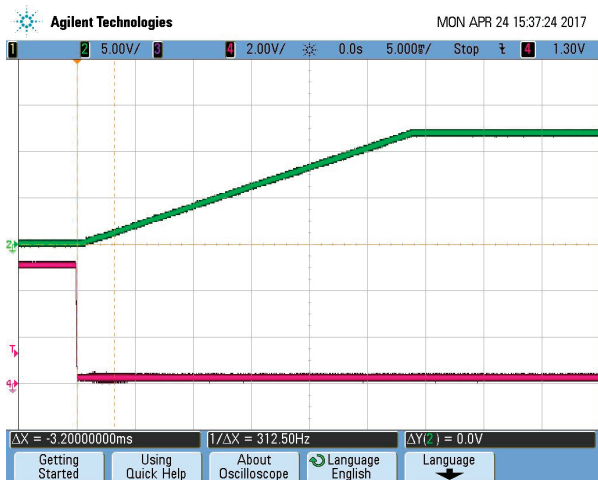

Figure 10. Enable Start-up Delay (CH2: Vout, CH4: On/Off)
(Vin=48V, Iout=50A, Cload=330µF, Ta=+25°C, 5ms/div)

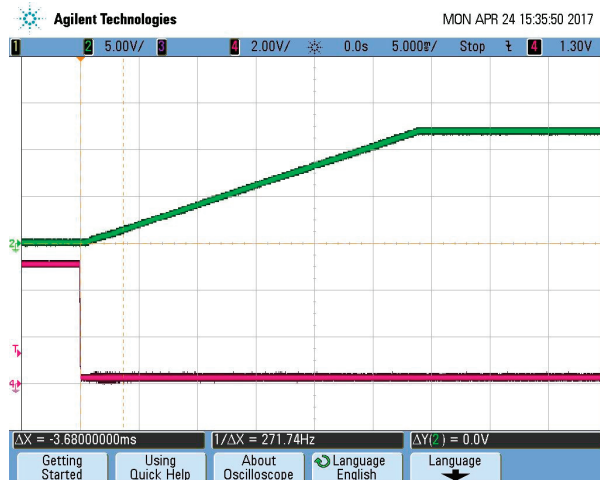

Figure 11. Vin Start-up Delay (CH2: Vout, CH1: Vin)
(Vin=48V, Iout=0A, Cload=330µF, Ta=+25°C, 20ms/div)

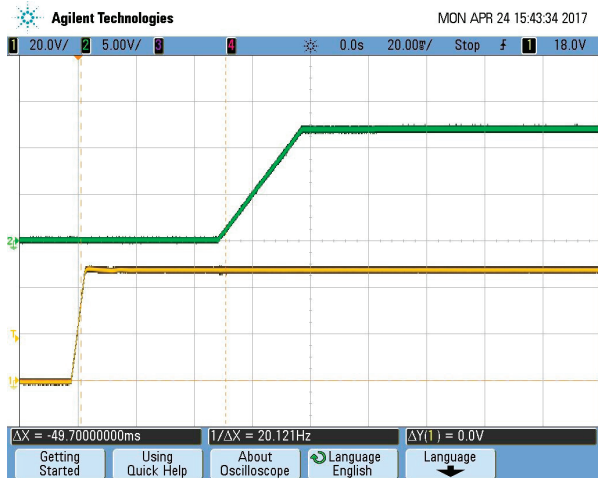
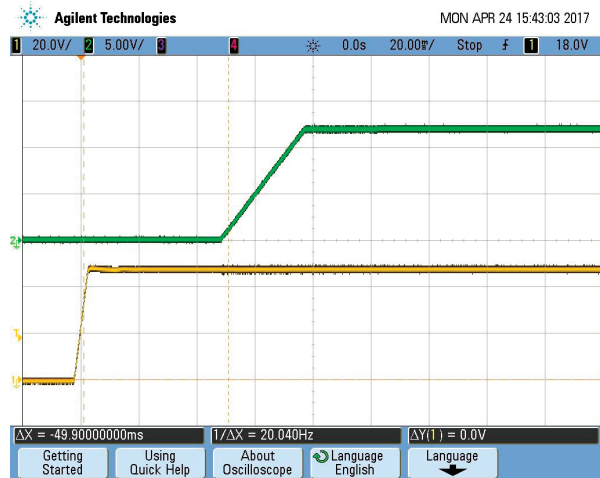
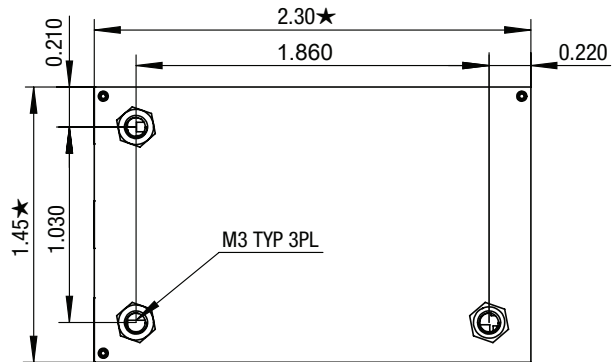

Figure 12. Vin Start-up Delay (CH2: Vout, CH1: Vin)
(Vin=48V, Iout=50A, Cload=330µF, Ta=+25°C, 20ms/div)



MECHANICAL SPECIFICATIONS

TOP VIEW



SIDE VIEW

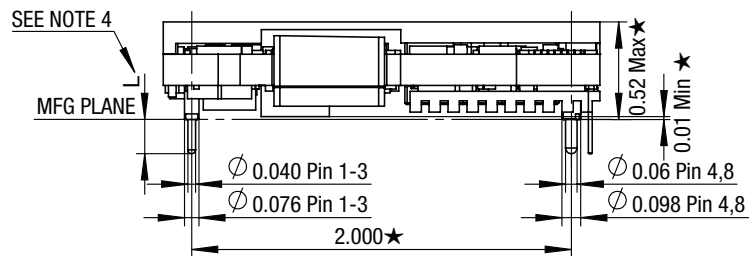

BOTTOM VIEW

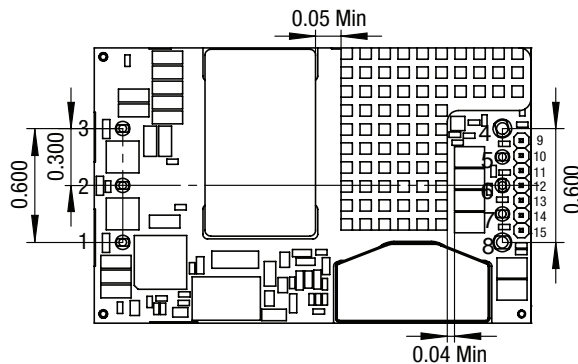

Material:
Dia 0.040 PINS: COPPER ALLOY
FINISH: (ALL PINS)
GOLD (5µ"MIN), OVER NICKEL (100µ"MIN)

NOTES:

UNLESS OTHERWISE SPECIFIED

- [1] M3 SCREW USED TO BOLT UNIT'S BASEPLATE TO OTHER SURFACES (SUCH AS HEATSINK) MUST NOT EXCEED 0.110" (2.8mm) DEPTH BELOW THE SURFACE OF BASEPLATE.
- [2] APPLIED TORQUE PER SCREW SHOULD NOT EXCEED 5.3In-lb (0.6Nm).
- [3] ALL DIMENSION ARE IN INCHES (MILLIMETER).
- [4] STANDARD PIN LENGTH: 0.180Inch.
- [5] FOR L2 PIN LENGTH OPTION IN MODEL NAME., USE STANDARD L2 PIN WITH PIN LENGTH TO 0.145Inch.
- [6] ALL TOLERANCES:
x.xx in, ±0.02 in (x.xmm, ±0.5mm)
x.xxx in, ±0.01 in (x.xmm, ±0.25mm).
- [7] COMPONENTS WILL VARY BETWEEN MODELS.

Please refer to the part number structure for alternate pin lengths.

RECOMMENDED FOOTPRINT

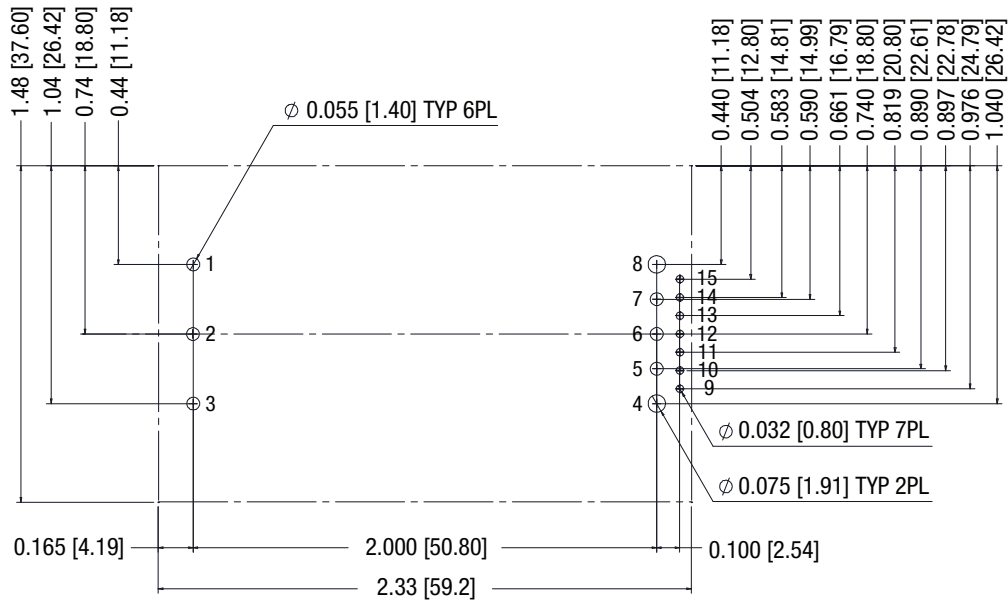

INPUT/OUTPUT CONNECTIONS				DSQ		DAQ	DCQ
PIN	Name	Input/Output	Function	Without "S" Option	With "S" option		
				1	Vin+		
2	On/Off	Input	Remote on/off control, Refer to technical notes section " Remote On/Off Control " for details	•	•	•	•
3	Vin-	Output	Input Voltage negative connection	•	•	•	•
4	Vout-	Output	Converter's main output voltage return connection	•	•	•	•
5	Sense-	Input	Sense inputs to compensate output voltage inaccuracy delivered at the load, refer to technical notes section " Remote Sense Input " for detail description	•		•	
6	Trim	Input	Output voltage can be trimmed up or down by external connection of a resistor between Trim pin and either Sense pin. Refer to technical notes section " TRIM " for details	•		•	
7	Sense+	Input	Sense inputs to compensate output voltage inaccuracy delivered at the load, Refer to technical notes section " Remote Sense Input " for details	•		•	
8	Vout+	Output	Converter's main output voltage + connection	•	•	•	•
9	PGood	Output	Power good function; refer to technical notes section " Power Good " TTL level: Output Low < 0.4V; Output High > 2.4V; Output sinking/sourcing current max: 4mA	•	•		
10	Sig_Gnd	Output	Return ground for PMBUS and PGood. It is recommend to design independent signal ground separate from the power ground to minimize noise interference	•	•		
11	Data	Input/Output	Refer to section " PMBus " for details; Internal pull up: 10k	•	•		
12	SMBALERT#	Output		•	•		
13	Clock	Input/Output		•	•		
14	Addr1	Input		•	•		
15	Addr0	Input		Connect resistor to GND to configure PMBUS address per " PMBus Addressing " details in the PMBus Section	•	•	

SHIPPING TRAYS AND BOXES, THROUGH-HOLE MOUNT

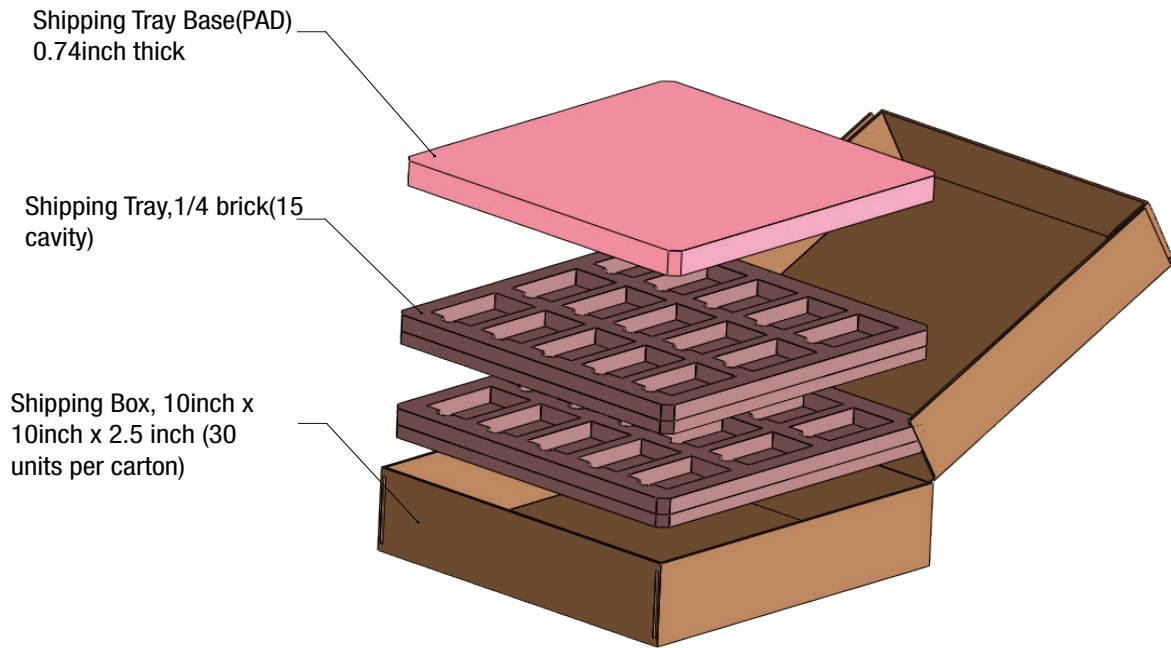

SHIPPING TRAY DIMENSIONS

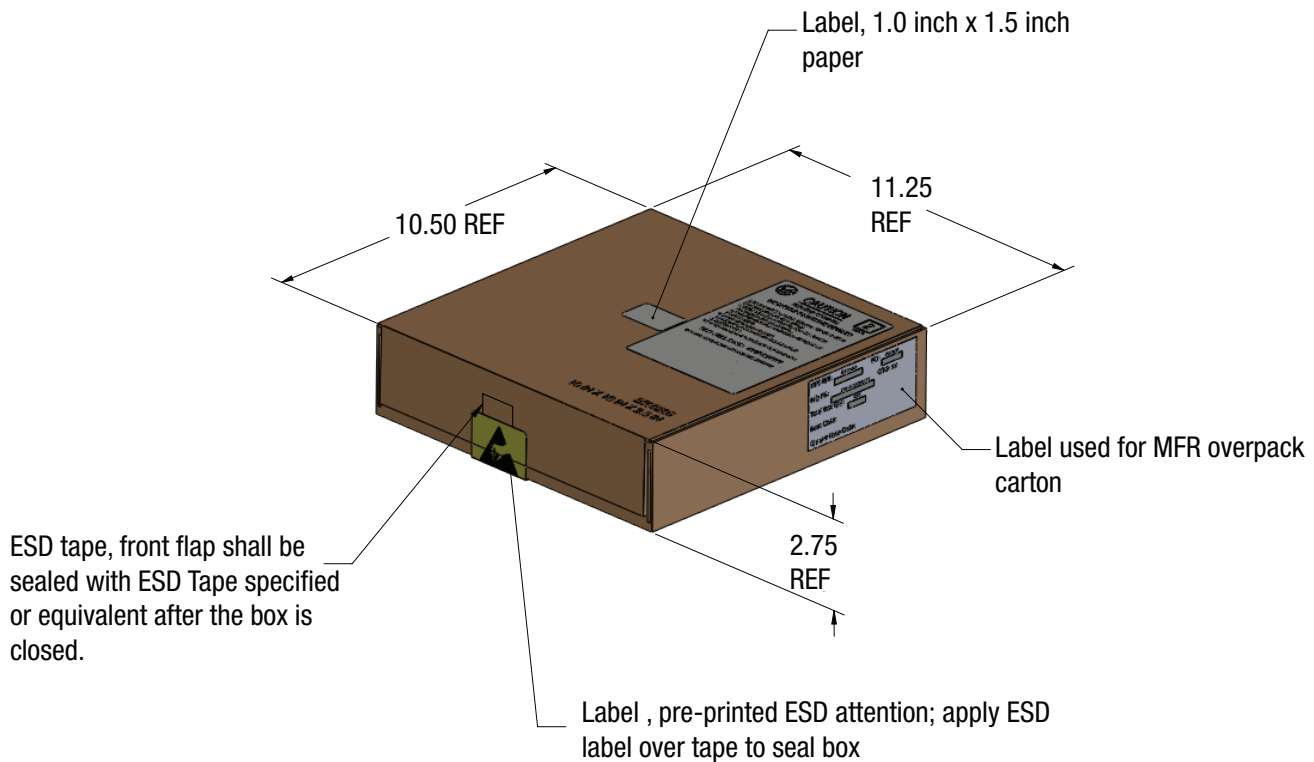

CLOSED CARTON

SHIPPING TRAYS DIMENSIONS

Material: LOW DENSITY CLOSED CELL POLYETHYLENE STATIC DISSIPATIVE FOAM

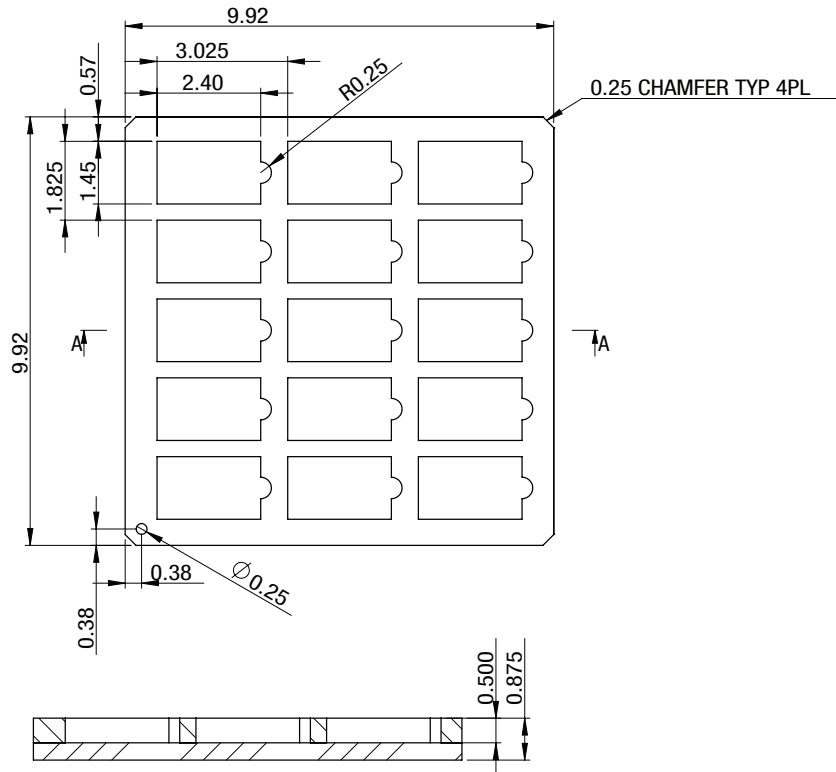

SECTION A-A
SCALE 1 : 3

Dimensions are in inches shown for ref. only.

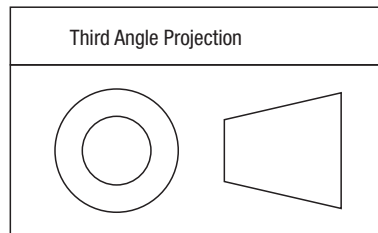

Tolerances (unless otherwise specified):

.XX ± 0.02

.XXX ± 0.010

Angles ± 1°

SHIPPING TRAYS AND BOXES FOR R-OPTION

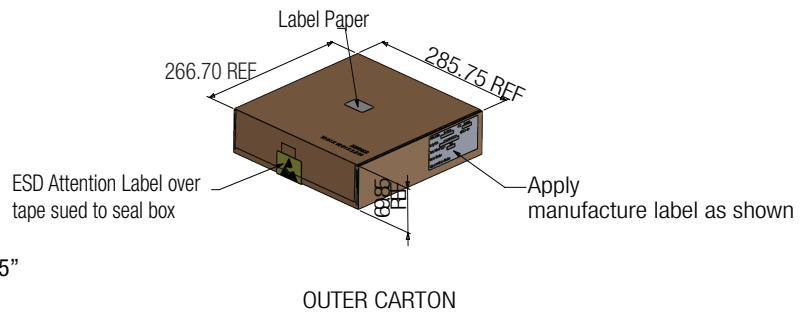
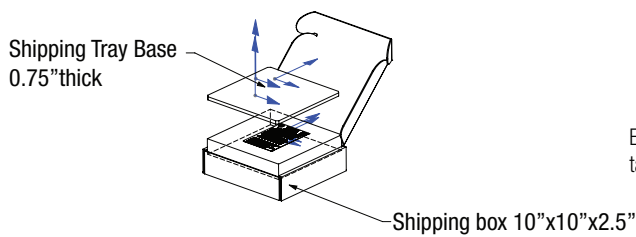
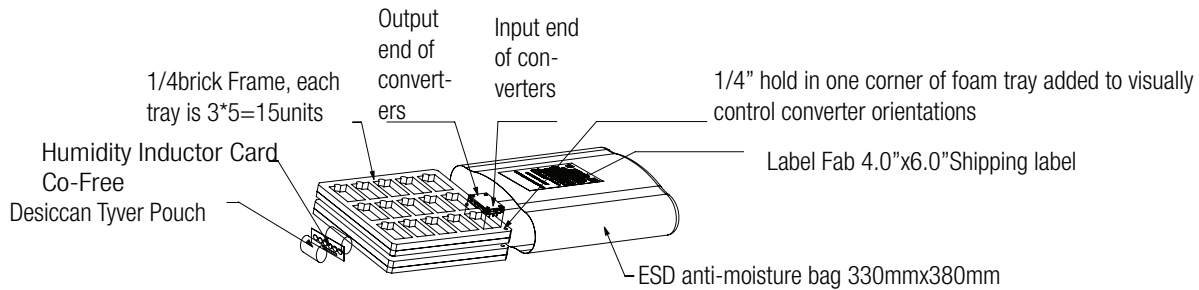

SHIPPING TRAYS DIMENSIONS For R-OPTION

Material: LOW DENSITY CLOSED CELL POLYETHYLENE STATIC DISSIPATIVE FOAM

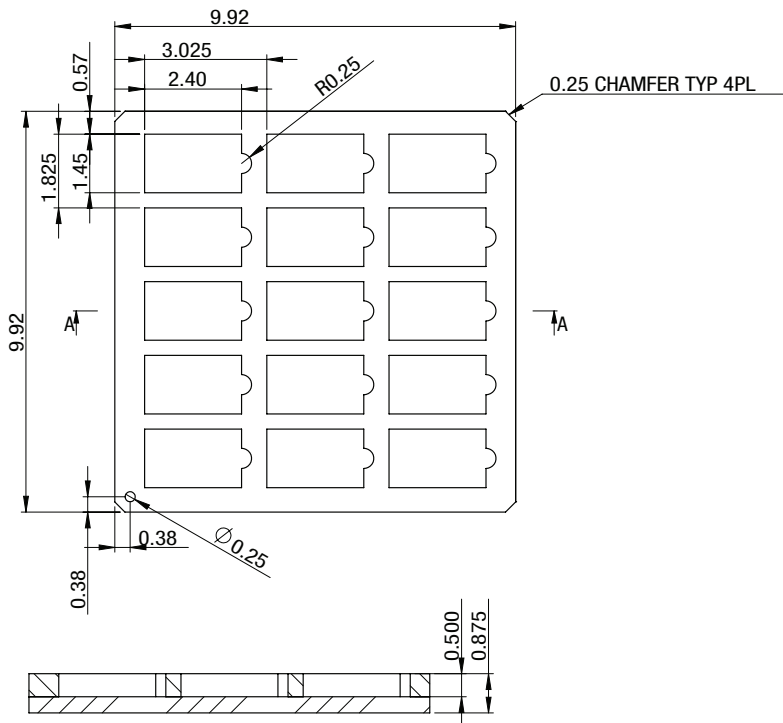

SECTION A-A
SCALE 1 : 3

Dimensions are in inches shown for ref. only.

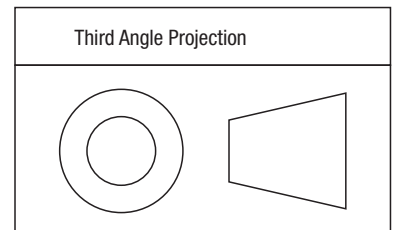

Tolerances (unless otherwise specified):
.XX ± 0.02
.XXX ± 0.010
Angles ± 1°

TECHNICAL & APPLICATIONS OVERVIEW

Power Management Overview and PMBus Interface (Applicable Models)

A wide range of parameters can be read and configured by the system/host by using PMBus™ digital communications.

Each module is provided pre-configured for a wide range operation. Refer to the [PMBus™ Interface](#) section for details.

SMBALERT# Hardware Signal (Applicable Models)

[SMBALERT#](#) signal offers an alternate method for system/host notification that a fault or Warning has been detected (mirrors the STATUS_X fault/warn register bits) within the module and is useful in applications requiring real time fault notification independent or in addition to reading PMBus™ STATUS_X register fault bits which may not be read by system/host frequently enough to detect that a fault/warning bit flag was set.

Internally driven low <0.4Vdc indicates a Vout, Iout, Vin, Temperature, or Power Good fault/warning has been detected and remains low until the fault/warning stimulus has been removed and the system/host clears the individual bit flag or issues "CLEAR_FAULTS" command.

Drive high, >2.4Vdc to indicate no fault conditions within power module are detected.

Soft-start Power Up

The default rise time of the ramp up is 30ms. When starting by applying input voltage the control circuit boot-up time adds an additional 10ms delay. The soft-start power up of the module can be reconfigured using the PMBus interface.

Output Over Voltage Protection (OVP)

Both OVP limit and response can be configured via PMBus command (See PMBus Command 40h VOUT_OV_FAULT_LIMIT [for details](#)). The default output OVP limit is set to 20% above nominal output voltage and responds by immediately shutdown of main output and restarts when the fault condition no longer exists.

Over Current Protection (OCP, Current limit)

The module includes current limiting circuitry for protection at continuous over load. The default setting for the product is hiccup mode. The current limit can be configured by PMBus command 0x46, IOUT_OC_FAULT_LIMIT, to be greater than the IOUT_OC_WARN_LIMIT (PMBus Command 0x4A). The maximum value that the current limit could be set is 50A.

Power Good

The module provides [Power Good](#) (PG) flag in the STATUS_WORD register that indicates the output voltage is within a specified tolerance of its target level and no fault condition exists. The Power Good pin default logic is negative and it can be configured by MFR_PGOOD_POLARITY.

Parallel Load Sharing (S Option, Droop Load Sharing)

Two or more converters may be connected in parallel at both the input and output terminals to support higher output current or to improve reliability due to the reduced stress that result when the modules are operating below their rated limits. For applications requiring current share, followed the guidelines below. The products have a pre-configured voltage droop. The stated output voltage set point

is at no load. The output voltage will decrease when the load current is increased. The voltage will drop 0.35V while load reaches max load. Our goal is to have each converter contribute nearly identical current into the output load under all input, environmental and load conditions.

CAUTION: This converter is not internally fused. To avoid danger to persons or equipment and to retain safety certification, the user must connect an external fast-blow input fuse as listed in the specifications. Be sure that the PC board pad area and etch size are adequate to provide enough current so that the fuse will blow with an overload.

Using Parallel Connections – Redundancy (N+1)

The redundancy connections require external user supplied "OR"ing diodes or "OR"ing MOSFETs for reliability purposes. The diodes allow for an uninterrupted power system operation in case of a catastrophic failure (shorted output) by one of the converters.

The diodes should be identical part numbers to enhance balance between the converters. The default factory nominal voltage should be sufficiently matched between converters. The OR'ing diode system is the responsibility of the user. Be aware of the power levels applied to the diodes and possible heat sink requirements.

Schottky power diodes with approximately 0.3V drops or "OR"ing MOSFETs may be suitable in the loop whereas 0.7 V silicon power diodes may not be advisable. In the event of an internal device fault or failure of the mains power modules on the primary side, the other devices automatically take over the entire supply of the loads. In the basic N+1 power system, the "N" equals the number of modules required to fully power the system and "+1" equals one back-up module that will take over for a failed module. If the system consists of two power modules, each providing 50% of the total load power under normal operation and one module fails, another one delivers full power to the load. This means you can use smaller and less expensive power converters as the redundant elements, while achieving the goal of increased availability.

Start Up Considerations

When power is first applied to the DC-DC converter, there is some risk of startup difficulties if you do not have both low AC and DC impedance and adequate regulation of the input source. Make sure that your source supply does not allow the instantaneous input voltage to go below the minimum voltage at all times. Use a moderate size capacitor very close to the input terminals. You may need two or more parallel capacitors. A larger electrolytic or ceramic cap supplies the surge current and a smaller parallel low-ESR ceramic cap gives low AC impedance.

Remember that the input current is carried both by the wiring and the ground plane return. Make sure the ground plane uses adequate thickness copper. Run additional bus wire if necessary.

Input Fusing

Certain applications and/or safety agencies may require fuses at the inputs of power conversion components. Fuses should also be used when there is the possibility of sustained input voltage reversal which is not current-limited. For greatest safety, we recommend a fast blow fuse installed in the ungrounded input supply line.

Input Under-Voltage Shutdown and Start-Up Threshold

Converters will not begin to fully regulate until the rising input voltage exceeds and remains at the Start-Up Threshold Voltage (see Specifications). Once operating, converters will not turn off until the input voltage drops below the Under-Voltage Shutdown Limit. Subsequent restart will not occur until the input voltage rises again above the Start-Up Threshold. This built-in hysteresis prevents any unstable on/off operation at a single input voltage. The over/under-voltage fault level and fault response and hysteresis can be configured via the PMBus interface. See commands 0x55 (VIN_OV_FAULT_LIMIT) and 0x59 (VIN_UV_FAULT_LIMIT) in the PMBus command list for additional details

Start-Up Time

Turn-on time (see Specifications) is the time interval between the point when the rising input voltage crosses the Start-Up Threshold and the output voltage rises to within 10% of regulation point.

These converters include a soft start circuit to control Vout ramp time, thereby limiting the input inrush current.

The On/Off Remote Control interval from On command to Vout (final ±10%) assumes that the converter already has its input voltage stabilized above the Start-Up Threshold before the On command. The interval is measured from the On command until the output enters and remains within its specified accuracy band. See PMBus command 0x60 (TON_DELAY) for additional configuration [details](#)

Recommended Input Filtering

The user must assure that the input source has low AC impedance to provide dynamic stability and that the input supply has little or no inductive content, including long distributed wiring to a remote power supply. The converter will operate with no additional external capacitance if these conditions are met.

For best performance, we recommend installing a low-ESR capacitor immediately adjacent to the converter's input terminals. The capacitor should be a ceramic type such as the Murata GRM32 series or a polymer type. More input bulk capacitance may be added in parallel (either electrolytic or tantalum) if needed.

Recommended Output Filtering

This series achieves it's rated output ripple and noise without additional external capacitance. However, the user may install external output capacitance to further improve ripple or for improved dynamic response, however low-ESR ceramic (Murata GRM32 series) or polymer capacitors must be used and mounted close to the converter using only as much capacitance as required to achieve your ripple and noise objectives. Excessive capacitance may make step load recovery sluggish and/or introduce instability. Never exceed the maximum rated output capacitance listed in the specifications.

Input Ripple Current and Output Noise

All models in this converter series are tested and specified for input reflected ripple current and output noise using designated external input/output components, circuits and layout as shown in the figures below. The Cbus and Lbus components simulate a typical DC voltage bus.

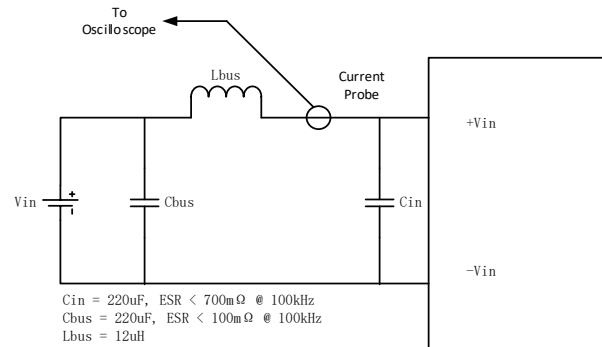

Figure 14. Measuring Input Ripple Current

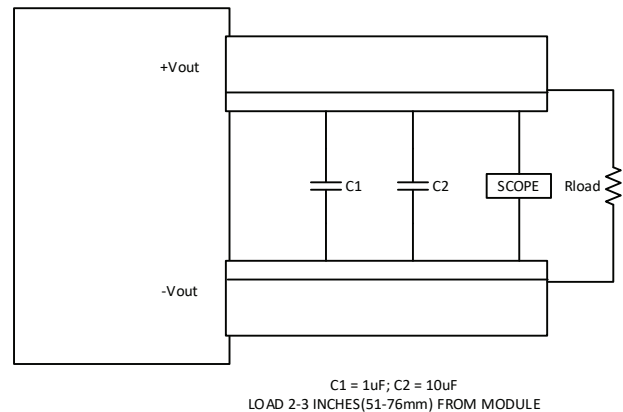

Figure 15. Measuring Output Ripple and Noise (PARD)

Minimum Output Loading Requirements

All models regulate within specification and are stable under no load to full load conditions.

Thermal Shutdown (OTP)

This series includes thermal sense and shutdown circuitry that protects itself from overtemperature conditions. Upon detection of overtemperature condition defined by PMBus command 0x4F "OT_FAULT_LIMIT", the module enters OTP and shuts down. Once the temperature falls below restart threshold, as defined in PMBus command list, (OT_FAULT_LIMIT, 0x4F and MFR_OT_FAULT_HYS, 0xEA), the module automatically restarts. OTP fault limit and recovery hysteresis are configurable via [PMBus](#).

CAUTION: If you operate too close to the thermal limits, the converter may shut down suddenly without warning. Be sure to thoroughly test your application to avoid unplanned thermal shutdown.

Temperature Derating Curves

The graphs in this data sheet illustrate typical operation under a variety of conditions. The Derating curves show the maximum continuous ambient air temperature and decreasing maximum output current which is acceptable under increasing

forced airflow measured in Linear Feet per Minute (“LFM”). Note that these are AVERAGE measurements. The converter will accept brief increases in current or reduced airflow as long as the average is not exceeded.

Note that the temperatures are of the ambient airflow, not the converter itself which is obviously running at higher temperature than the outside air. Also note that “natural convection” is defined as very low flow rates which are not using fan-forced airflow. Depending on the application, “natural convection” is usually about 30-65 LFM but is not equal to still air (0 LFM).

Murata Power Solutions makes Characterization measurements in a closed cycle wind tunnel with calibrated airflow. We use both thermocouples and an infrared camera system to observe thermal performance. As a practical matter, it is quite difficult to insert an anemometer to precisely measure airflow in most applications. Sometimes it is possible to estimate the effective airflow if you thoroughly understand the enclosure geometry, entry/exit orifice areas and the fan flow rate specifications.

CAUTION: If you exceed these Derating guidelines, the converter may have an unplanned Over Temperature shut down. Also, these graphs are all collected near Sea Level altitude. Be sure to reduce the derating for higher altitude.

Output Short Circuit Condition

The short circuit condition is an extension of the “Current Limiting” condition. When the monitored peak current signal reaches a certain range, the PWM controller’s outputs are shut off thereby turning the converter “off.” This is followed by an extended time out period. This period can vary depending on other conditions such as the input voltage level. Following this time out period, the PWM controller will attempt to re-start the converter by initiating a “normal start cycle” which includes soft start. If the “fault condition” persists, another “hiccup” cycle is initiated. This “cycle” can and will continue indefinitely until such time as the “fault condition” is removed, at which time the converter will resume “normal operation.” Operating in the “hiccup” mode during a fault condition is advantageous in that average input and output power levels are held low preventing excessive internal increases in temperature.

Remote On/Off Control

The DSQ series modules are equipped with an [On/Off control pin](#) (internal pull up, TTL open-collector and/or CMOS open-drain compatible) and is configurable via PMBus interface. Output is enabled when the On/Off is grounded or brought to within a low voltage (see specifications) with respect to –Vin. The device is off (disabled) when the On/Off is left open or is pulled high to +13.5Vdc with respect to –Vin. The On/Off function allows the module to be turned on/off by an external device switch.

The restart delay for this module to turn On/Off by the On/Off control pin is 200ms.

On/Off can be configured by PMBus command [0xDD](#) (MFR_PRIMARY_ON_OFF_CONFIG); default configuration does not ignore the control pin and therefore requires the On/Off control pin to be asserted to start the unit.

On/Off status is dependent on On/Off control and OPERATION (PMBus command) status; both must be ON to turn DSQ on; if one of them is OFF, unit will be turned off.

Output Capacitive Load

These converters do not require external capacitance added to achieve rated specifications. Users should only consider adding capacitance to reduce switching noise and/or to handle spike current load steps. Install only enough capacitance to achieve noise objectives. Excess external capacitance may cause degraded transient response and possible oscillation or instability.

Remote Sense Input

Use the [Sense inputs](#) with caution. Sense is normally connected at the load. Sense inputs compensate for output voltage inaccuracy delivered at the load. This is done by correcting IR voltage drops along the output wiring and the current carrying capacity of PC board etches. This output drop (the difference between Sense and Vout when measured at the converter) should not exceed 0.5V. Consider using heavier wire if this drop is excessive. Sense inputs also improve the stability of the converter and load system by optimizing the control loop phase margin.

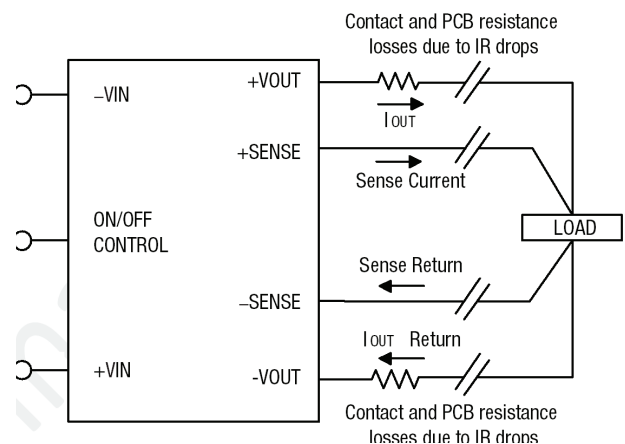

Figure 16. Remote Sense Circuit Configuration

Note: The Sense input and power Vout lines are internally connected through low value resistors to their respective polarities so that the converter can operate without external connection to the Sense. Nevertheless, if the Sense function is not used for remote regulation, the user should connect +Sense to +Vout and –Sense to –Vout at the converter pins.

The remote Sense lines carry very little current. They are also capacitively coupled to the output lines and therefore are in the feedback control loop to regulate and stabilize the output. As such, they are not low impedance inputs and must be treated with care in PC board layouts. Sense lines on the PCB should run adjacent to DC signals, preferably Ground. In cables and discrete wiring, use twisted pair, shielded tubing or similar techniques.

Any long, distributed wiring and/or significant inductance introduced into the Sense control loop can adversely affect overall system stability. If in doubt, test your applications by observing the converter’s output transient response during step loads. There should not be any appreciable ringing or oscillation. You may also adjust the output trim slightly to compensate for voltage loss in any external filter elements. Do not exceed maximum power ratings.

Please observe Sense inputs tolerance to avoid improper operation:

$$[Vout(+)-Vout(-)] - [Sense(+)-Sense(-)] \leq 5\% \text{ of } Vout$$

Output overvoltage protection is monitored at the output voltage pin, not the Sense pin. Therefore excessive voltage differences between Vout and Sense together with trim adjustment of the output can cause the overvoltage protection circuit to activate and shut down the output.

Power derating of the converter is based on the combination of maximum output current and the highest output voltage. Therefore the designer must ensure:

$$(V_{out} \text{ at pins}) \times (I_{out}) \leq (\text{Max. rated output power})$$

Soldering Guidelines

Murata Power Solutions recommends the specifications below when installing these converters. These specifications vary depending on the solder type. Exceeding these specifications may cause damage to the product. Be cautious when there is high atmospheric humidity. We strongly recommend a mild pre-bake (100° C for 30 minutes). Your production environment may differ; therefore please thoroughly review these guidelines with your process engineers.

Wave Solder Operation for Through-Hole Mounted Products (THMT)	
For Sn/Ag/Cu based solders:	
Maximum Preheat Temperature	115
Maximum Pot Temperature	270
Maximum Solder Dwell Time	7 seconds
For Sn/Pb based solders:	
Maximum Preheat Temperature	105
Maximum Pot Temperature	250
Maximum Solder Dwell Time	6 seconds

PIH Soldering Profile

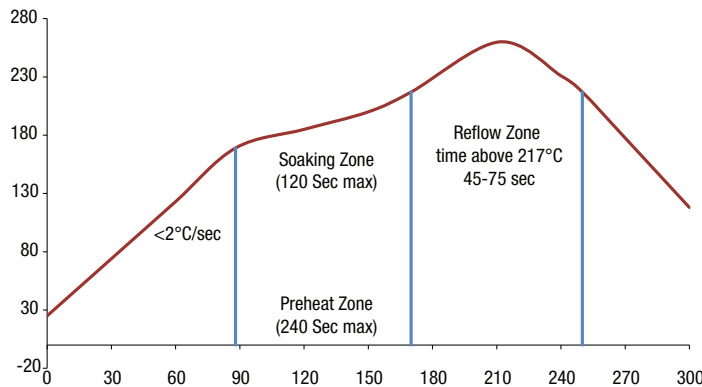

Figure 18. PIH Soldering Profile

Trimming the Output Voltage (See Specification Note 7)

The Trim input pin is used to adjust the output voltage over the rated trim range (please refer to the Specifications). As illustrated in the trim equations and circuit diagrams below, trim adjustments use a single fixed resistor connected between the Trim input and either Vout Sense pin. Trimming resistors should have a low temperature coefficient (± 100 ppm/deg.C or less) and be mounted close to the converter keeping leads short. If the trim function is not used, leave the trim unconnected, the converter will default to its specified output voltage accuracy.

CAUTION:

1. Avoid activating shutdown protection (OVP, OCP, OTP) by ensuring the output voltage or output power is not exceeded when setting the output voltage trim.
2. Keep the trim external connections as short as possible to avoid excessive noise that may otherwise cause instability or oscillation using shielding if needed.

Trim Equations (based on 12V models¹)

$$R_{adj_up} \text{ (in } k\Omega) = 5.11 \times \left[\frac{12V \times (1 + \Delta)}{1.225 \times \Delta} - \frac{1}{\Delta} - 2 \right]$$

where $\Delta = \frac{V_{out} - 12V}{12V}$

$$R_{adj_down} \text{ (in } k\Omega) = 5.11 \times \left[\frac{1}{\Delta} - 2 \right]$$

where $\Delta = \frac{12V - V_{out}}{12V}$

Where Vout = Desired output voltage. Adjustment accuracy is subject to resistor tolerances and factory-adjusted output accuracy. Mount trim resistor close to converter. Use short leads. Note that "Δ" is given as a small fraction, not a percentage.

¹ "12V": substitute the appropriate output voltage for the specific model being used: 2V, 3.3V, or 5V.

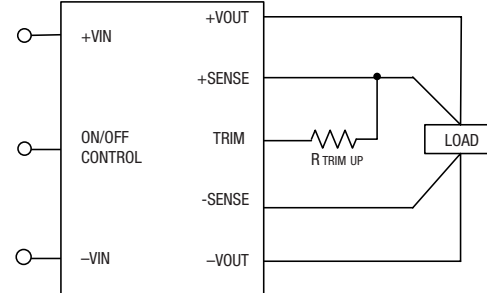
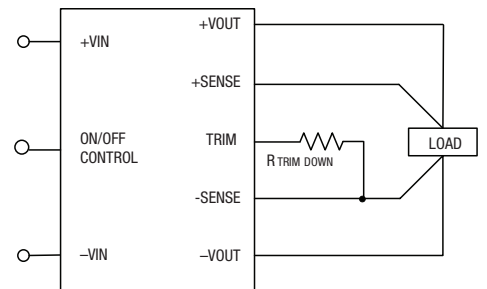

Emissions Performance

Murata Power Solutions measures its products for conducted emissions against the EN 55022 and CISPR 22 standards. Passive resistance loads are employed and the output is set to the maximum voltage. If you set up your own emissions testing, make sure the output load is rated at continuous power while doing the tests.

The recommended external input and output capacitors (if required) are included. Please refer to the fundamental switching frequency. All of this information is listed in the Product Specifications. An external discrete filter is installed and the circuit diagram is shown below.

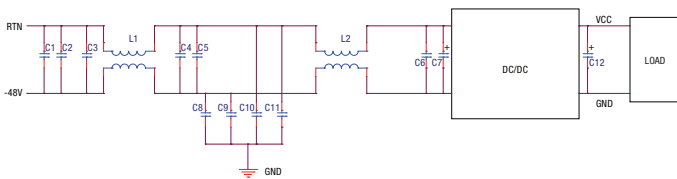

[1] Conducted Emissions Parts List

Reference	Part Number	Description	Vendor
C1, C2, C3, C4, C5	GRM32ER72A105KA01L	SMD CERAMIC-100V-1000nF-X7R-1210	Murata
C6	GRM319R72A104KA01D	SMD CERAMIC100V-100nF-±10%-X7R-1206	Murata
L1, L2	PG0060T	COMMON MODE-473uH-±25%-14A	Pulse
C8, C9, C10, C11	GRM55DR72J224KW01L	SMD CERAMIC630V-0.22uF-±10%-X7R-2220	Murata
C7	UHE2A221MHD	Aluminum100V-220Uf-±10%-long lead	Nichicon
C12	NA		

[2] Conducted Emissions Test Equipment Used

- Hewlett Packard HP8594L Spectrum Analyzer – S/N 3827A00153
- 2 Line V-networks LS1-15V 50Ω/50Uh Line Impedance Stabilization Network

[3] Conducted Emissions Test Results

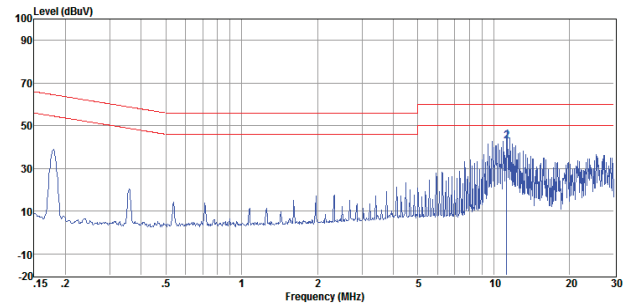

Graph 1. Conducted emissions performance, Positive Line, CISPR 22, Class B, full load

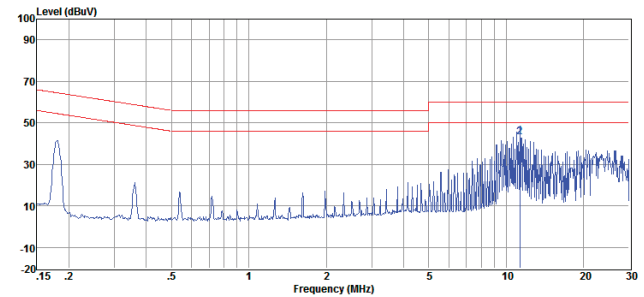

Graph 2. Conducted emissions performance, Negative Line, CISPR 22, Class B, full load

[4] Layout Recommendations

Most applications can use the filtering which is already installed inside the converter or with the addition of the recommended external capacitors. For greater emissions suppression, consider additional filter components and/or shielding. Emissions performance will depend on the user's PC board layout, the chassis shielding environment and choice of external components.

Since many factors affect both the amplitude and spectra of emissions, we recommend using an engineer who is experienced at emissions suppression.

PMBus™ Digital Communications Protocol

This module offers a PMBus digital interface that enables the user to configure many characteristics of the device operation as well as to monitor the input and output voltages, output current and device temperature. The module can be used with any standard two-wire I²C or SMBus host device.

A system controller (host device) can monitor a wide variety of parameters through the PMBus interface and detect fault conditions by monitoring the SMBALERT# pin, which will be asserted when any number of pre-configured fault or warning conditions occurs. The system controller can also continuously monitor any number of power conversion parameters including but not limited to the following:

- [1] Input voltage
- [2] Output voltage
- [3] Output current
- [4] Module temperature

Software Tools for Design and Production

For these modules, Murata-PS provides software for configuring and monitoring via the PMBus interface. For more information please contact your local Murata-PS representative.

Standard PMBus™ characteristics

- Complies with “Power Systems Management Protocol Specification Part 1 General Requirements Transport and Electrical requirements revision 1.2” & “Power Systems Management Protocol Specification Part 2 Command Language revision 1.2”
- Linear data format is used for all supported parameters unless noted
- Up to 400kHz I²C communications bus speed is supported
- SMBALERT## is supported
- PEC is supported
- Clock stretching is supported

PMBus SIGNAL LOGIC				
Logic Level	Minimum	Nominal	Maximum	Units
Bus Speed			400	kHz
Logic high (input)	2.0		3.3	Vdc
Logic Low (Input)	0		0.8	Vdc
Logic High (output)	2.4			Vdc
Logic Low (output)			0.4	Vdc

PMBus Addressing

This power module series offers three address configurations to support a wide range of applications. The address is set by externally connecting two resistors from each of the two [address pins](#) “Addr1” and “Addr0” to signal ground “Sig_Gnd” and forms two octal (0 to 7) digits, each pin setting one digit. The resistor value for each digit is defined according to the desired configuration.

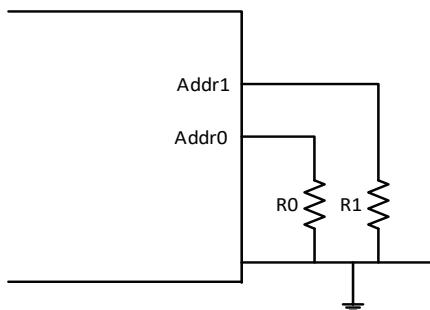

PMBus™ Addressing Continued

Configuration Options:

The address configurations can be set or changed via PMBus™ Command [0xF5](#). The default address configuration from factory is “Configuration 0” described below.

Configuration 0 (default):

If the calculated PMBus address is 0~12D, 40D, 44D, 45D or 55D, SA0 or SA1 is left open, address 127D is assigned by default.

Digit	Resistor Value R_{SA0}/R_{SA1} [kΩ]
0	10
1	15.4
2	23.7
3	36.5
4	54.9
5	84.5
6	130
7	200
Calculation: $PMBus_Address = 8x (SA1 \text{ index}) + (SA0 \text{ index})$	

Configuration 1:

If the calculated PMBus address is 0d, 11d or 12d, SA0 or SA1 is left open, address 119d is assigned by default.

Digit	Resistor Value R_{SA0}/R_{SA1} [kΩ]
0	10
1	22
2	33
3	47
4	68
5	100
6	150
7	220
Calculation: $PMBus_Address = 8 \times (SA0 \text{ value}) + (SA1 \text{ value})$	

Configuration 2:

If the calculated PMBus address is 0~12D, 40D, 44D, 45D or 55D, SA0 or SA1 is left open, address 88D is assigned by default.

Digit	Resistor Value R_{SA0}/R_{SA1} [kΩ]
0	24.9
1	49.9
2	75
3	100
4	124
5	150
6	174
7	200
Calculation: $PMBus_Address = 16 \times Addr1 + Addr0$	

Follow these steps to change the power module address configuration:

- 1) Select the desired address configuration via PMBus command [0xF5](#).
- 2) Save configuration to non-volatile user store memory by writing command [0x15](#) “STORE_USER_ALL”.
- 3) Recycle input power

Supported PMBus™ Command List (default values, based on 12V models)

CMD	Command Name	Transaction Type "Write"	Transaction Type "Read"	QTY Data Bytes	Default Value	Lower Limit	Upper Limit	Unit	Note
01h	OPERATION	Write Byte	Read Byte	1	0x80				Only support 0x80 and 0x00
03h	CLEAR_FAULTS	Send byte	N/A	0	N/A				
10h	WRITE_PROTECT	Write Byte	Read Byte	1	0x00				
11h	STORE_DEFAULT_ALL	Send byte	N/A	0	N/A				
12h	RESTORE_DEFAULT_ALL	Send byte	N/A	0	N/A				
15h	STORE_USER_ALL	Send byte	N/A	0	N/A				
16h	RESTORE_USER_ALL	Send byte	N/A	0	N/A				
19h	CAPABILITY	N/A	Read Byte	1	0xB0				
20h	VOUT_MODE	N/A	Read Byte	1	0x17				
21h	VOUT_COMMAND	Write Word	Read Word	2	12.000	9.600	14.000	V	
22h	VOUT_TRIM	Write Word	Read Word	2	0	0	0	V	Effective after turn off then to turn back on
28h	VOUT_DROOP	Write Word	Read Word	2	0/7	0	100	mΩ	Locked to 7mΩ in DROOP CURRENT SHARE mode; VOUT_DROOP is not used in CURRENT SHARE DISABLED mode
40h	VOUT_OV_FAULT_LIMIT	Write Word	Read Word	2	14	9.600	15.600	V	
41h	VOUT_OV_FAULT_RESPONSE	Write Byte	Read Byte	1	0xB8				7:6: All support 5:3: Only support latch or continuous hiccup 2:0: Set turn off delay when 7:6=01B, unit is 130ms
42h	VOUT_OV_WARN_LIMIT	Write Word	Read Word	2	13.500	9.600	15.600	V	
46h	IOUT_OC_FAULT_LIMIT	Write Word	Read Word	2	62.00	0.00	65.00	A	
47h	IOUT_OC_FAULT_RESPONSE	Write Byte	Read Byte	1	0xF8				7:6: 00B is continues operation without interruption, 01B/10B is not supported, 11B is supported. 5:3: Only support latch or continuous hiccup 2:0: Not supported
4Ah	IOUT_OC_WARN_LIMIT	Write Word	Read Word	2	60.00	0.00	65.00	A	
4Fh	OT_FAULT_LIMIT	Write Word	Read Word	2	122/128	30	130	°C	Default value of without "B" suffix: 122°C Default value of with "B" suffix: 128°C
50h	OT_FAULT_RESPONSE	Write Byte	Read Byte	1	0xB8				7:6: 00B is continues operation without interruption, 01B is not supported (same behavior as 00B), 10B/11B are supported. 5:3: Only support latch or continuous hiccup 2:0: Not supported
51h	OT_WARN_LIMIT	Write Word	Read Word	2	113	30	130	°C	
55h	VIN_OV_FAULT_LIMIT	Write Word	Read Word	2	110.00	32.00	110.00	V	
57h	VIN_OV_WARN_LIMIT	Write Word	Read Word	2	100.00	32.00	110.00	V	
58h	VIN_UV_WARN_LIMIT	Write Word	Read Word	2	32.50	30.00	75.00	V	
59h	VIN_UV_FAULT_LIMIT	Write Word	Read Word	2	31.25	30.00	75.00	V	
5Eh	POWER_GOOD_ON	Write Word	Read Word	2	10.199	1.000	13.200	V	
5Fh	POWER_GOOD_OFF	Write Word	Read Word	2	8.400	1.000	13.200	V	
61h	TON_RISE	Write Word	Read Word	2	30	20	100	ms	Write available in supervisor mode when droop current share on, available in both mode when droop current share off
78h	STATUS_BYTE	Write Byte	Read Byte	1	N/A				

CMD	Command Name	Transaction Type "Write"	Transaction Type "Read"	QTY Data Bytes	Default Value	Lower Limit	Upper Limit	Unit	Note
79h	STATUS_WORD	Write Word	Read Word	2	N/A				
7Ah	STATUS_VOUT	Write Byte	Read Byte	1	N/A				
7Bh	STATUS_IOUT	Write Byte	Read Byte	1	N/A				
7Ch	STATUS_INPUT	Write Byte	Read Byte	1	N/A				
7Dh	STATUS_TEMPERATURE	Write Byte	Read Byte	1	N/A				
7Eh	STATUS_CML	Write Byte	Read Byte	1	N/A				
88h	READ_VIN	N/A	Read Word	2	N/A			V	
8Bh	READ_VOUT	N/A	Read Word	2	N/A			V	
8Ch	READ_IOUT	N/A	Read Word	2	N/A			A	
8Dh	READ_TEMPERATURE_1	N/A	Read Word	2	N/A			°C	
94h	READ_DUTY_CYCLE	N/A	Read Word	2	N/A			%	
95h	READ_FREQUENCY	N/A	Read Word	2	N/A			KHZ	
96h	READ_POUT	N/A	Read Word	2	N/A			W	
98h	PMBUS_REVISION	N/A	Read Byte	1	0x42				
99h	MFR_ID	N/A	Block Read	22	"Murata Power Solutions"				
9Ah	MFR_MODEL	Block Write*	Block Read	<=20	N/A				
9Bh	MFR_REVISION	Block Write*	Block Read	<=10	N/A				
9Dh	MFR_DATE	Block Write*	Block Read	<=10	N/A				
9Eh	MFR_SERIAL	Block Write*	Block Read	<=20	N/A				
A0h	MFR_VIN_MIN	N/A	Read Word	2	36.00			V	
A1h	MFR_VIN_MAX	N/A	Read Word	2	75.00			V	
A2h	MFR_IIN_MAX	N/A	Read Word	2	19			A	
A3h	MFR_PIN_MAX	N/A	Read Word	2	625			W	
A4h	MFR_VOUT_MIN	N/A	Read Word	2	9.600			V	
A5h	MFR_VOUT_MAX	N/A	Read Word	2	13.199			V	
A6h	MFR_IOUT_MAX	N/A	Read Word	2	50.00			A	
A7h	MFR_POUT_MAX	N/A	Read Word	2	600			W	
A8h	MFR_TAMBIENT_MAX	N/A	Read Word	2	85			°C	
A9h	MFR_TAMBIENT_MIN	N/A	Read Word	2	-40			°C	

CMD	Command Name	Transaction Type "Write"	Transaction Type "Read"	QTY Data Bytes	Default Value	Lower Limit	Upper Limit	Unit	Note
C0h	MFR_MAX_TEMP_1	N/A	Read Word	2	130			°C	
DBh	MFR_CURRENT_SHARE_CONFIG	Write Byte*	Read Byte	1	0x00/0x01				Default value of DROOP CURRENT SHARE ENABLED mode: 0x01 Default value of DROOP CURRENT SHARE DISABLED mode: 0x00
DDh	MFR_PRIMARY_ON_OFF_CONFIG	Write Byte	Read Byte	1	0x04/0x06				Default value of negative logic: 0x04 Default value of positive logic: 0x06
DEh	MFR_PGOOD_POLARITY	Write Byte	Read Byte	1	0x00				
E8h	MFR_VIN_OV_FAULT_HYS	Write Word	Read Word	2	2.50	1.00	20.00	V	
E9h	MFR_VIN_UV_FAULT_HYS	Write Word	Read Word	2	2.50	1.00	20.00	V	
EAh	MFR_OT_FAULT_HYS	Write Word	Read Word	2	10	5	50	°C	
F5h	MFR_PMBUS_ADDRESSING	Write Byte	Read Byte	1	0x00				
F6h	MFR_CALIBRATION_STATUS	N/A	Read Byte*	1	0xC7				
F9h	MFR_VIN_SENSE_CALIBRATION	Write byte*	N/A	1	N/A				
FAh	MFR_IOUT_SENSE_CALIBRATION	Write Word*	N/A	2	N/A				
FBh	MFR_VOUT_SET_POINT_CALIBRATION	Write Word*	N/A	2	N/A				
FCh	MFR_SUPERVISOR_PASSWORD	Block Write	N/A	N/A	N/A				

Additional Command Language and Configuration Details:

Commands 01-CFh:

Refer to PMBUS 1.2 SPEC

Command DBh “MFR_CURRENT_SHARE_CONFIG”:

BITS	PURPOSE	VALUE	MEANING	CTRL/CS PIN	VOUT_DROOP	TON_DELAY	TOFF_DELAY	TON_RISE	TOFF_FALL
7:1		0000000	Reserved	--	--	--	--	--	--
0	Current share control	0	Current share disabled	CTRL	configurable	configurable	configurable	configurable	configurable
		1	Droop current share mode enabled	CTRL	locked to 0x000A	locked to 0x0001	locked to 0x0000	locked to 0x0000	locked to 0x0000

Command DDh “MFR_PRIMARY_ON_OFF_CONFIG”:

BITS	PURPOSE	VALUE	MEANING
7:3		00000	Reserved
2	Controls how the unit responds to the CONTROL pin	0	Unit ignores the primary ON/OFF pin
		1	Unit requires the primary ON/OFF pin to be asserted to start the unit.
1	Polarity of primary ON/OFF logic	0	Active low (Pull pin low to start the unit)
		1	Active high (Pull high or open to start the unit)
0		0	Reserved

Command DEh “MFR_PGOOD_POLARITY”:

BITS	PURPOSE	VALUE	MEANING
7:1		0000000	Reserved
0	Power good polarity of pin 12	0	Negative logic, output low if Vout rises to specific value
		1	Positive logic, output high if Vout rises to specific value

Command E8h “MFR_VIN_OV_FAULT_HYS”:

Hysteresis of VIN_OV_FAULT recover, Linear data format

Command E9h “MFR_VIN_UV_FAULT_HYS”:

Hysteresis of VIN_UV_FAULT recover, Linear data format

Command EAh “MFR_OT_FAULT_HYS”:

Hysteresis of OT_FAULT recover, Linear data format

Command F5h “MFR_PMBUS_ADDRESSING”

0x00: Addressing configuration 0 (Default)
0x01: Addressing configuration 1
0x02: Addressing configuration 2
0x03~0xFF: Rsvd

Command F6h “MFR_CALIBRATION_STATUS”:

Refer to calibration procedure file

Command F9h “MFR_VIN_SENSE_CALIBRATION”:

Refer to calibration procedure file

Command FAh “MFR_IOUT_SENSE_CALIBRATION”:

Refer to calibration procedure file

Additional Command Language and Configuration Details Continued:

Command FBh “MFR_VOUT_SET_POINT_CALIBRATION”

Refer to calibration procedure file

Command FCh “MFR_SUPERVISOR_PASSWORD”

Set unit to supervisor mode or ROM mode, Refer to password table

Status_Register Bit Names

GREEN = supported

STATUS_VOUT
7 VOUT_OV_FAULT
6 VOUT_OV_WARNING
5 VOUT_UV_WARNING
4 VOUT_UV_FAULT
3 VOUT_MAX Warning
2 TON_MAX_FAULT
1 TOFF_MAX_WARNING
0 VOUT Tracking Error

STATUS_IOUT
7 IOUT_OC_FAULT
6 IOUT_OC_LV_FAULT
5 IOUT_OC_WARNING
4 IOUT_UC_FAULT
3 Current Share Fault
2 In Power Limiting Mode
1 POUT_OP_FAULT
0 POUT_OP_WARNING

STATUS_TEMPERATURE
7 OT_FAULT
6 OT_WARNING
5 UT_WARNING
4 UT_FAULT
3 Reserved
2 Reserved
1 Reserved
0 Reserved

STATUS_CML
7 Invalid/Unsupported Command
6 Invalid/Unsupported Data
5 Packet Error Check Failed
4 Memory Fault Detected
3 Processor Fault Detected
2 Reserved
1 Other Communication Fault
0 Other Memory Or Logic Fault

STATUS_WORD
7 VOUT
6 IOUT/POUT
5 INPUT
4 MFR_SPECIFIC
3 POWER_GOOD#
2 FANS
1 OTHER
0 UNKNOWN
7 BUSY
6 OFF
5 VOUT_OV_FAULT
4 IOUT_OC_FAULT
3 VIN_UV_FAULT
2 TEMPERATURE
1 CML
0 NONE OF THE ABOVE

STATUS_OTHER
7 Reserved
6 Reserved
5 Input A Fuse/Breaker Fault
4 Input B Fuse/Breaker Fault
3 Input A OR-ing Device Fault
2 Input B OR-ing Device Fault
1 Output OR-ing Device Fault
0 Reserved

STATUS_INPUT
7 VIN_OV_FAULT
6 VIN_OV_WARNING
5 VIN_UV_WARNING
4 VIN_UV_FAULT
3 Unit Off For Low Input Voltage
2 IIN_OC_FAULT
1 IIN_OC_WARNING
0 PIN_OP_WARNING

STATUS_MFR_SPECIFIC
Manufacturer Defined
Manufacturer Defined
Manufacturer Defined
Manufacturer Defined
Manufacturer Defined
Manufacturer Defined
Manufacturer Defined
Manufacturer Defined

STATUS_FANS_1_2
7 Fan 1 Fault
6 Fan 2 Fault
5 Fan 1 Warning
4 Fan 2 Warning
3 Fan 1 Speed Override
2 Fan 2 Speed Override
1 Air Flow Fault
0 Air Flow Warning

STATUS_FANS_3_4
7 Fan 3 Fault
6 Fan 4 Fault
5 Fan 3 Warning
4 Fan 4 Warning
3 Fan 3 Speed Override
2 Fan 4 Speed Override
1 Reserved
0 Reserved

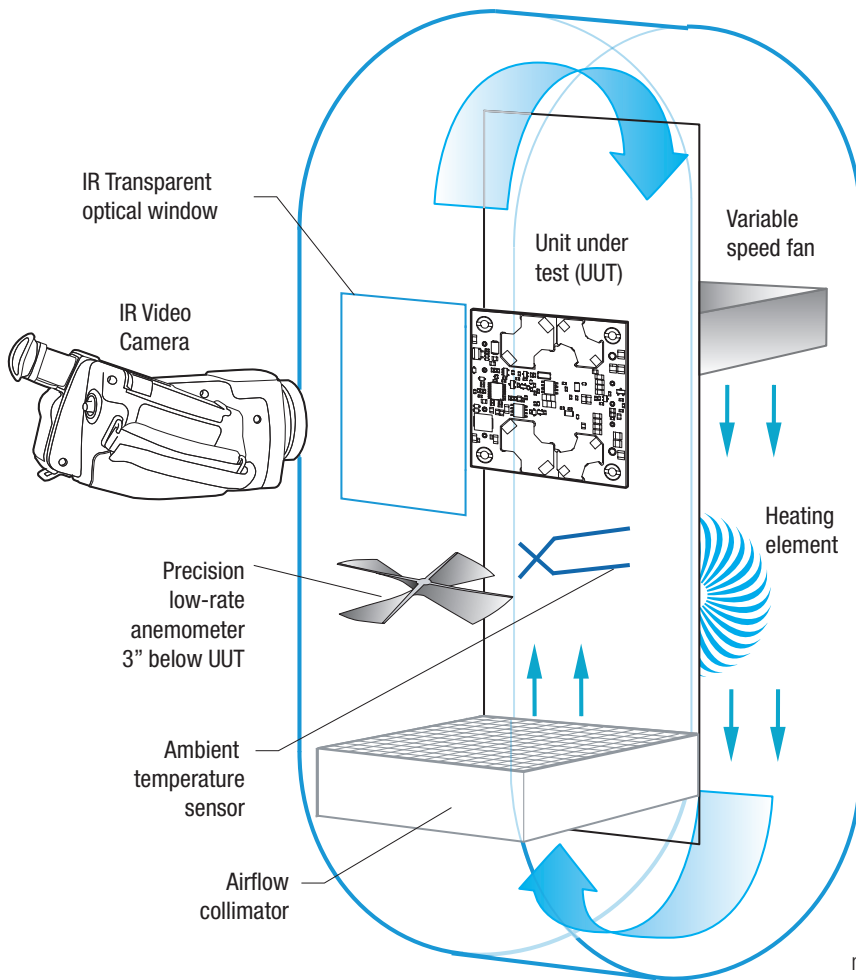

Figure 16. Vertical Wind Tunnel

Vertical Wind Tunnel

Murata Power Solutions employs a computer controlled custom-designed closed loop vertical wind tunnel, infrared video camera system, and test instrumentation for accurate airflow and heat dissipation analysis of power products. The system includes a precision low flow-rate anemometer, variable speed fan, power supply input and load controls, temperature gauges, and adjustable heating element.

The IR camera monitors the thermal performance of the Unit Under Test (UUT) under static steady-state conditions. A special optical port is used which is transparent to infrared wavelengths.

Both through-hole and surface mount converters are soldered down to a 10" x 10" host carrier board for realistic heat absorption and spreading. Both longitudinal and transverse airflow studies are possible by rotation of this carrier board since there are often significant differences in the heat dissipation in the two airflow directions. The combination of adjustable airflow, adjustable ambient heat, and adjustable Input/Output currents and voltages mean that a very wide range of measurement conditions can be studied.

The collimator reduces the amount of turbulence adjacent to the UUT by minimizing airflow turbulence. Such turbulence influences the effective heat transfer characteristics and gives false readings. Excess turbulence removes more heat from some surfaces and less heat from others, possibly causing uneven overheating.

Both sides of the UUT are studied since there are different thermal gradients on each side. The adjustable heating element and fan, built-in temperature gauges, and no-contact IR camera mean that power supplies are tested in real-world conditions.

