

# REL-PR3-110DC/3X21 - Single relay



2908893

<https://www.phoenixcontact.com/us/products/2908893>

Please be informed that the data shown in this PDF document is generated from our online catalog. Please find the complete data in the user documentation. Our general terms of use for downloads are valid.

Plug-in high-power relay with power contacts, 3 N/O contacts, coil voltage: 110 V DC



## Commercial data

Item number	2908893
Packing unit	1 pc
Minimum order quantity	1 pc
Sales key	C460
Product key	CK6193
Catalog page	Page 312 (C-5-2019)
GTIN	4055626353913
Weight per piece (including packing)	87.4 g
Weight per piece (excluding packing)	87.4 g
Customs tariff number	85364900
Country of origin	PL

# REL-PR3-110DC/3X21 - Single relay



2908893

<https://www.phoenixcontact.com/us/products/2908893>

## Technical data

### Notes

General	The outputs are not suitable for switching different outer conductors.
General	Do not use to separate SELV / PELV circuits from other circuits, because safe isolation is not guaranteed.

### Product properties

Product type	Single relay
Operating mode	100% operating factor
Mechanical service life	approx. $10^7$ cycles

### Insulation characteristics

Insulation	Basic insulation
------------	------------------

### Insulation characteristics

Insulation	Basic insulation
Overvoltage category	III
Pollution degree	3

### Electrical properties

Service life electrical	see diagram
Maximum power dissipation for nominal condition	1.5 W
Test voltage (Winding/contact)	2.5 kV <sub>rms</sub> (50 Hz, 1 min., winding/contact)
Test voltage (Changeover contact/changeover contact)	2.5 kV <sub>rms</sub> (50 Hz, 1 min., changeover contact/changeover contact)
Rated insulation voltage	250 V AC
Rated surge voltage	4 kV

### Input data

#### Coil side

Nominal input voltage $U_N$	110 V DC
Input voltage range	93.5 V DC ... 121 V DC (20 °C)
Drive and function	monostable
Drive (polarity)	non-polarized
Typical input current at $U_N$	12 mA
Input power dissipation for $U_N$	1.32 W
Typical response time	20 ms
Typical release time	15 ms
Coil resistance	9200 $\Omega$ $\pm$ 10 %

### Output data

#### Switching

# REL-PR3-110DC/3X21 - Single relay



2908893

<https://www.phoenixcontact.com/us/products/2908893>

Contact switching type	3 changeover contacts
Type of switch contact	Single contact
Contact material	AgNi
Maximum switching voltage	440 V AC 250 V DC
Minimum switching voltage	10 V (At 24 mA)
Limiting continuous current	16 A
Maximum inrush current	50 A (20 ms, N/O contacts)
Min. switching current	10 mA (at 24 V)
Interrupting rating (ohmic load) max.	384 W (at 24 V DC) 124 W (at 48 V DC) 108 W (at 60 V DC) 52 W (at 110 V DC) 70 W (at 220 V DC) 4000 VA (for 250 V AC) 4000 VA (at 440 V AC)
3-phase motor load	1500 W (at 400 V, AC3)
Motor load according to UL 508	1/3 HP, 120 V AC (single-phase AC motor) 1/2 HP, 240 V AC (single-phase AC motor) 1/2 HP, 240 V AC (three-phase induction motor)

## Connection data

Connection method	Plug-in connection
-------------------	--------------------

## Dimensions

Width	38.6 mm
Height	36.1 mm
Depth	45.5 mm

## Environmental and real-life conditions

### Ambient conditions

Degree of protection	RT I
Degree of protection (Installation location)	≥ IP54 (Installation location)
Ambient temperature (operation)	-40 °C ... 70 °C
Ambient temperature (storage/transport)	-40 °C ... 85 °C
Altitude	≤ 2000 m

## Approvals

### Corrosive gas test

Identification	ISA-S71.04. G3 Harsh Group EN 60068-2-60
----------------	---

## Standards and regulations

Standards/regulations	IEC 60664
-----------------------	-----------

# REL-PR3-110DC/3X21 - Single relay



2908893

<https://www.phoenixcontact.com/us/products/2908893>

	IEC 61810
--	-----------

## Mounting

Mounting position	any
-------------------	-----

## Drawings

Diagram

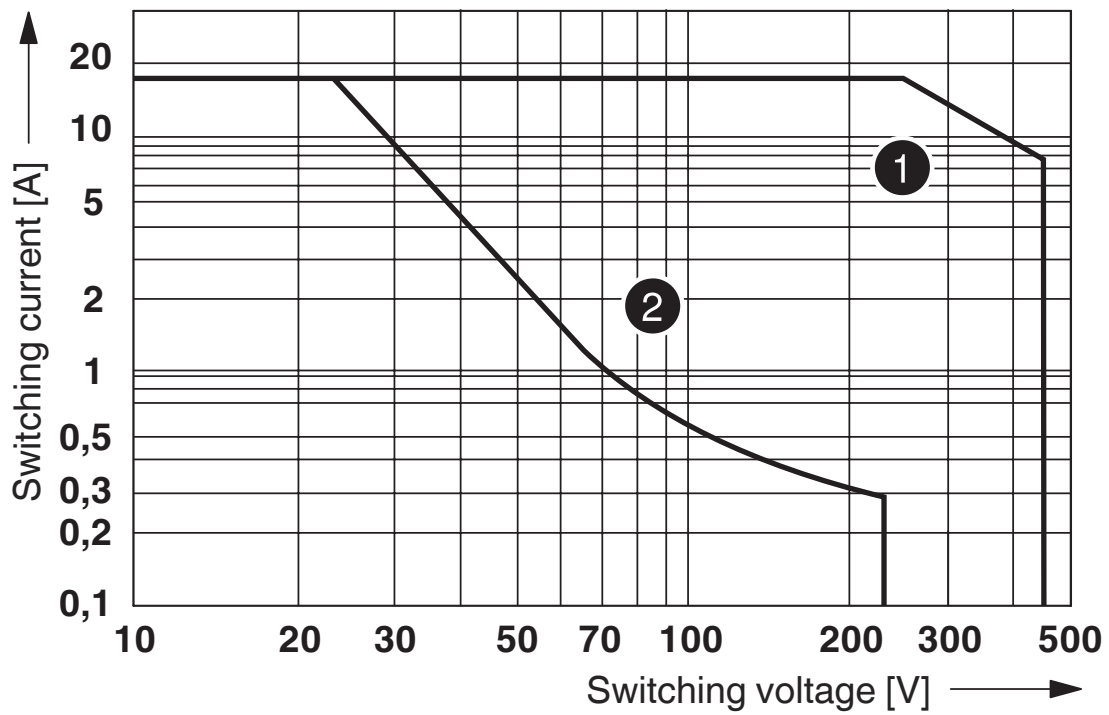

① AC, ohmic load

② DC, ohmic load

Interrupting rating

Diagram

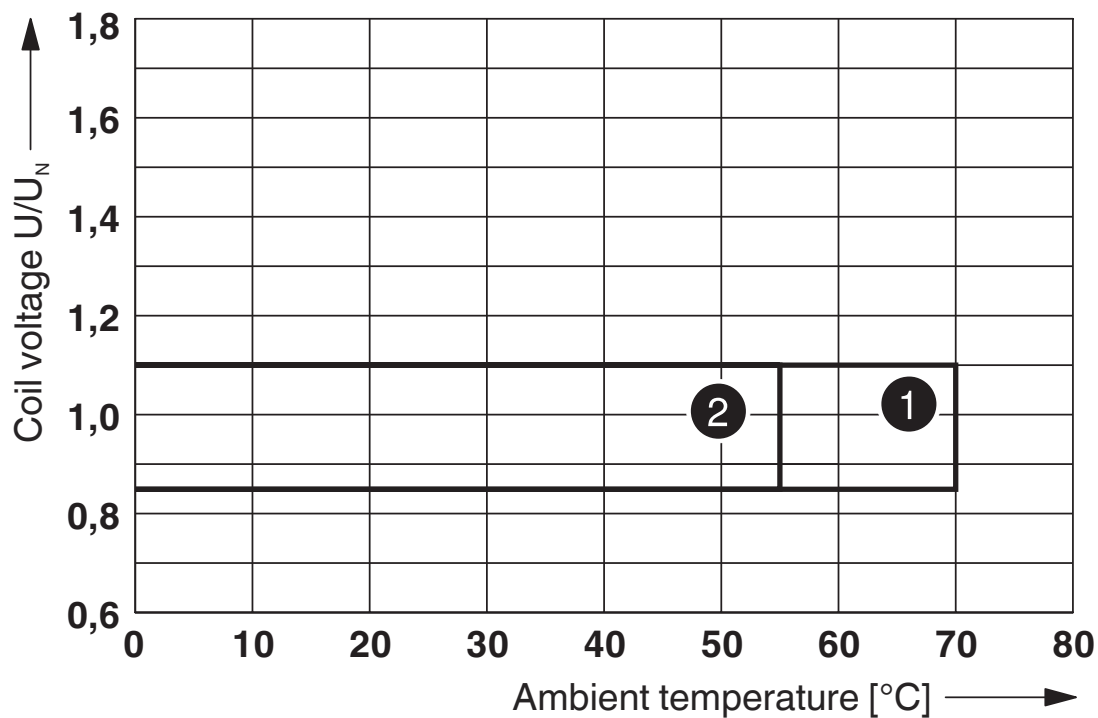

- ① DC coils
- ② AC coils

Operating voltage range

Circuit diagram

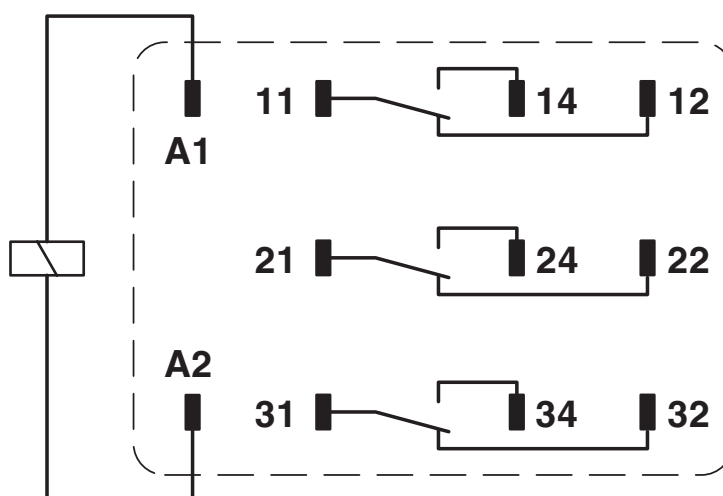

Diagram

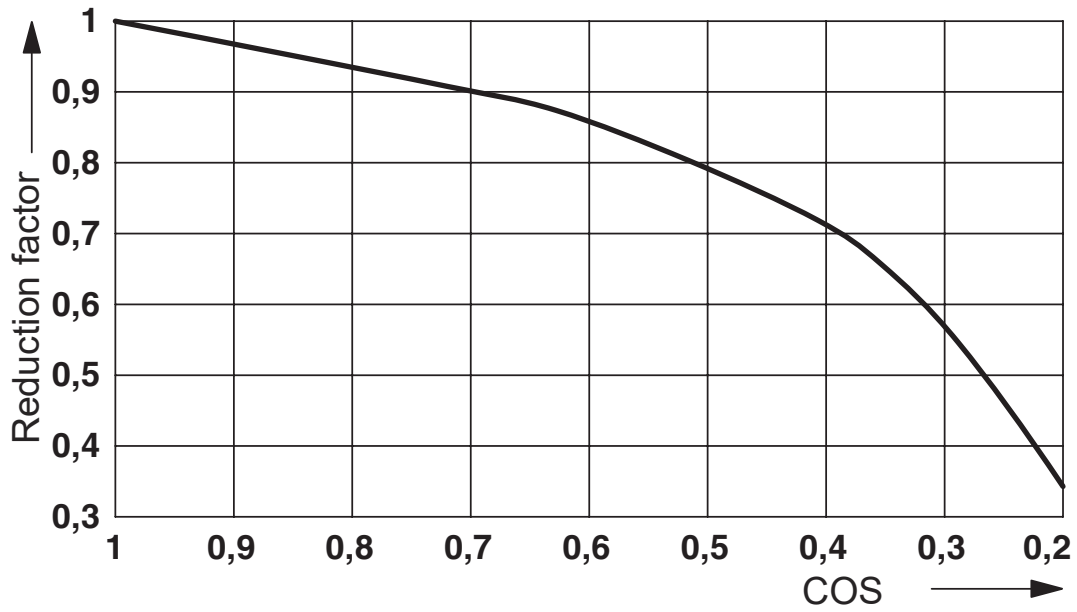

Service life reduction factor

# REL-PR3-110DC/3X21 - Single relay



2908893

<https://www.phoenixcontact.com/us/products/2908893>

Diagram

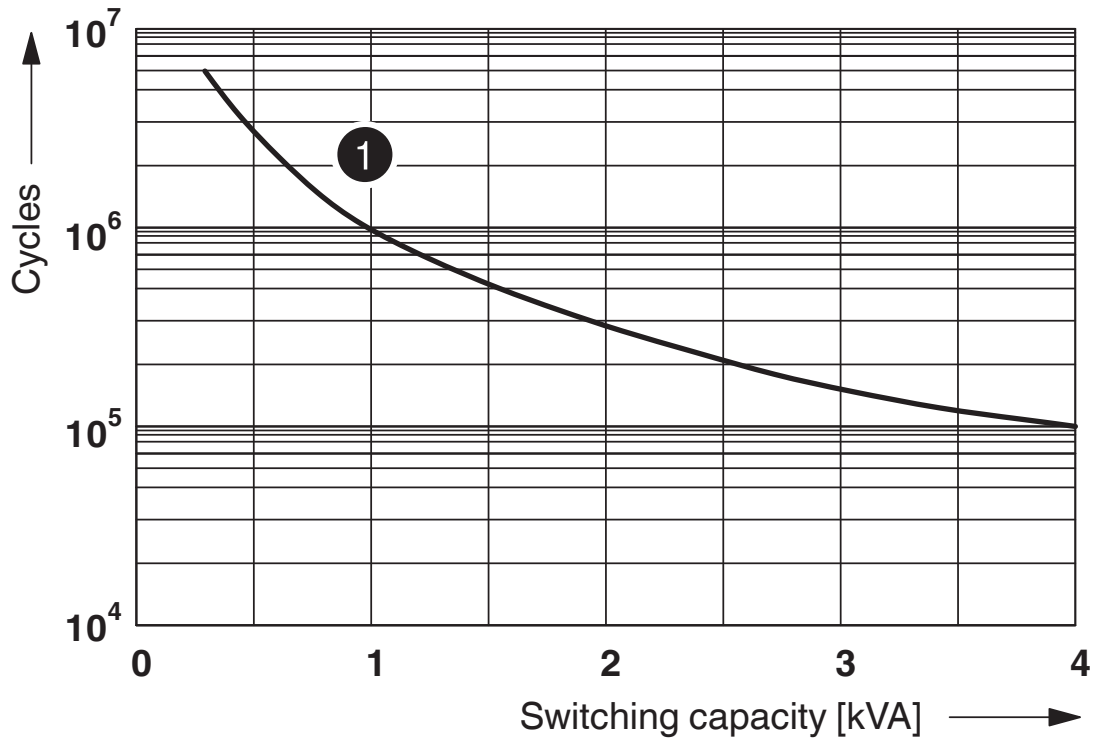

① 250 V AC, Ohmic load

Electrical service life



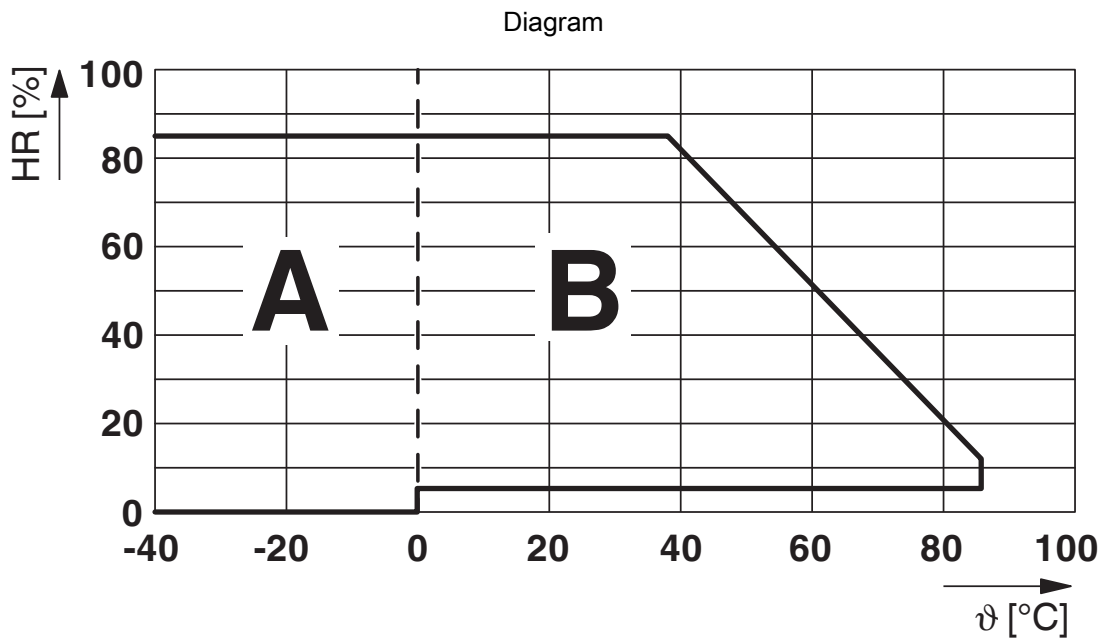

Permissible humidity for operation and storage.

The maximum permissible ambient temperature as specified in the data sheet must be observed.

Area A: Ice buildup at ambient temperatures  $\leq 0^\circ\text{C}$  must be prevented

Area B: Condensation at ambient temperatures  $> 0^\circ\text{C}$  must be prevented

On 30 full days that are naturally distributed across an entire year, a humidity level of 95% is permissible at an ambient temperature  $\leq 25^\circ\text{C}$ .

# REL-PR3-110DC/3X21 - Single relay



2908893

<https://www.phoenixcontact.com/us/products/2908893>

## Approvals

To download certificates, visit the product detail page: <https://www.phoenixcontact.com/us/products/2908893>



**CSA**

Approval ID: 256725



**cUL Recognized**

Approval ID: FILE E 172140



**UL Recognized**

Approval ID: FILE E 172140



**EAC**

Approval ID: TR\_TS\_D\_00573\_c



**EAC**

Approval ID: RU\*C-DE.\*08.B.00010

**cULus Recognized**

# REL-PR3-110DC/3X21 - Single relay



2908893

<https://www.phoenixcontact.com/us/products/2908893>

## Classifications

### ECLASS

ECLASS-11.0	27371601
ECLASS-12.0	27371601
ECLASS-13.0	27371601

### ETIM

ETIM 9.0	EC001437
----------	----------

### UNSPSC

UNSPSC 21.0	39122300
-------------	----------

# REL-PR3-110DC/3X21 - Single relay



2908893

<https://www.phoenixcontact.com/us/products/2908893>

## Environmental product compliance

China RoHS	Environmentally friendly use period: unlimited = EFUP-e
	No hazardous substances above threshold values

# REL-PR3-110DC/3X21 - Single relay



2908893

<https://www.phoenixcontact.com/us/products/2908893>

## Mandatory accessories

### RIF-4-BPT/3X21 - Relay base

2900961

<https://www.phoenixcontact.com/us/products/2900961>

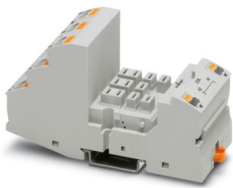

Relay base RIF-4..., for high-power relay with 2 or 3 changeover contacts or 3 N/O contacts, Push-in connection, plug-in option for input/interference suppression modules, for mounting on NS 35/7,5

### RIF-4-BSC/3X21 - Relay base

2900960

<https://www.phoenixcontact.com/us/products/2900960>

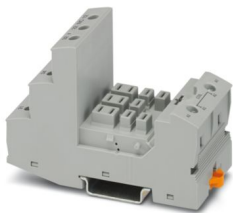

RIF-4... relay base, for high-power relay with 2 or 3 changeover contacts or 3 N/O contacts, screw connection, plug-in option for input/interference suppression modules, for mounting on NS 35/7,5

Phoenix Contact 2024 © - all rights reserved

<https://www.phoenixcontact.com>

Phoenix Contact USA

586 Fulling Mill Road

Middletown, PA 17057, United States

(+717) 944-1300

[info@phoenixcon.com](mailto:info@phoenixcon.com)