



SIRIUS soft starter 200-480 V 47 A, 110-250 V AC Screw terminals Analog output













product brand name	SIRIUS
product category	Hybrid switching devices
product designation	Soft starter
product type designation	3RW52
manufacturer's article number	<ul style="list-style-type: none"> • of standard HMI module usable 3RW5980-0HS00 • of high feature HMI module usable 3RW5980-0HF00 • of communication module PROFINET standard usable 3RW5980-0CS00 • of communication module PROFIBUS usable 3RW5980-0CP00 • of communication module Modbus TCP usable 3RW5980-0CT00 • of communication module Modbus RTU usable 3RW5980-0CR00 • of communication module Ethernet/IP 3RW5980-0CE00 • of circuit breaker usable at 400 V 3RV2032-4JA10: Type of coordination 1, Iq = 65 kA, CLASS 10 • of circuit breaker usable at 500 V 3RV2032-4JA10: Type of coordination 1, Iq = 10 kA, CLASS 10 • of circuit breaker usable at 400 V at inside-delta circuit 3RV2032-4RA10: Type of coordination 1, Iq = 65 kA, CLASS 10 • of circuit breaker usable at 500 V at inside-delta circuit 3RV2032-4RA10: Type of coordination 1, Iq = 10 kA, CLASS 10 • of the gG fuse usable up to 690 V 3NA3824-6: Type of coordination 1, Iq = 65 kA • of the gG fuse usable at inside-delta circuit up to 500 V 3NA3824-6: Type of coordination 1, Iq = 65 kA • of full range R fuse link for semiconductor protection usable up to 690 V 3NE1021-2: Type of coordination 2, Iq = 65 kA • of back-up R fuse link for semiconductor protection usable up to 690 V 3NE8024-1: Type of coordination 2, Iq = 65 kA
General technical data	
starting voltage [%]	30 ... 100 %
stopping voltage [%]	50 %; non-adjustable
start-up ramp time of soft starter	0 ... 20 s
current limiting value [%] adjustable	130 ... 700 %
certificate of suitability	<ul style="list-style-type: none"> • CE marking Yes • UL approval Yes • CSA approval Yes
product component	<ul style="list-style-type: none"> • HMI-High Feature No • is supported HMI-Standard Yes • is supported HMI-High Feature Yes
product feature integrated bypass contact system	Yes
number of controlled phases	3

trip class	CLASS 10A (default) / 10E / 20E; acc. to IEC 60947-4-2
buffering time in the event of power failure	
• for main current circuit	100 ms
• for control circuit	100 ms
insulation voltage rated value	600 V
degree of pollution	3, acc. to IEC 60947-4-2
impulse voltage rated value	6 kV
blocking voltage of the thyristor maximum	1 400 V
service factor	1
surge voltage resistance rated value	6 kV
maximum permissible voltage for safe isolation	
• between main and auxiliary circuit	600 V
shock resistance	15 g / 11 ms, from 12 g / 11 ms with potential contact lifting
vibration resistance	15 mm to 6 Hz; 2g to 500 Hz
utilization category according to IEC 60947-4-2	AC 53a
reference code according to IEC 81346-2	Q
Substance Prohibitance (Date)	02/15/2018
product function	
• ramp-up (soft starting)	Yes
• ramp-down (soft stop)	Yes
• Soft Torque	Yes
• adjustable current limitation	Yes
• pump ramp down	Yes
• intrinsic device protection	Yes
• motor overload protection	Yes; Electronic motor overload protection
• evaluation of thermistor motor protection	No
• inside-delta circuit	Yes
• auto-RESET	Yes
• manual RESET	Yes
• remote reset	Yes; By turning off the control supply voltage
• communication function	Yes
• operating measured value display	Yes; Only in conjunction with special accessories
• error logbook	Yes; Only in conjunction with special accessories
• via software parameterizable	No
• via software configurable	Yes
• PROFenergy	Yes; in connection with the PROFINET Standard communication module
• firmware update	Yes
• removable terminal for control circuit	Yes
• torque control	No
• analog output	Yes; 4 ... 20 mA (default) / 0 ... 10 V (parameterizable with High Feature HMI)
Power Electronics	
operational current	
• at 40 °C rated value	47 A
• at 50 °C rated value	42 A
• at 60 °C rated value	36 A
operational current at inside-delta circuit	
• at 40 °C rated value	81.4 A
• at 50 °C rated value	72 A
• at 60 °C rated value	62.7 A
operating voltage	
• rated value	200 ... 480 V
• at inside-delta circuit rated value	200 ... 480 V
relative negative tolerance of the operating voltage	-15 %
relative positive tolerance of the operating voltage	10 %
relative negative tolerance of the operating voltage at inside-delta circuit	-15 %
relative positive tolerance of the operating voltage at inside-delta circuit	10 %
operating power for 3-phase motors	

<ul style="list-style-type: none"> • at 230 V at 40 °C rated value 	11 kW
<ul style="list-style-type: none"> • at 230 V at inside-delta circuit at 40 °C rated value 	22 kW
<ul style="list-style-type: none"> • at 400 V at 40 °C rated value 	22 kW
<ul style="list-style-type: none"> • at 400 V at inside-delta circuit at 40 °C rated value 	45 kW
Operating frequency 1 rated value	50 Hz
Operating frequency 2 rated value	60 Hz
relative negative tolerance of the operating frequency	-10 %
relative positive tolerance of the operating frequency	10 %
adjustable motor current	
<ul style="list-style-type: none"> • at rotary coding switch on switch position 1 	20 A
<ul style="list-style-type: none"> • at rotary coding switch on switch position 2 	21.8 A
<ul style="list-style-type: none"> • at rotary coding switch on switch position 3 	23.6 A
<ul style="list-style-type: none"> • at rotary coding switch on switch position 4 	25.4 A
<ul style="list-style-type: none"> • at rotary coding switch on switch position 5 	27.2 A
<ul style="list-style-type: none"> • at rotary coding switch on switch position 6 	29 A
<ul style="list-style-type: none"> • at rotary coding switch on switch position 7 	30.8 A
<ul style="list-style-type: none"> • at rotary coding switch on switch position 8 	32.6 A
<ul style="list-style-type: none"> • at rotary coding switch on switch position 9 	34.4 A
<ul style="list-style-type: none"> • at rotary coding switch on switch position 10 	36.2 A
<ul style="list-style-type: none"> • at rotary coding switch on switch position 11 	38 A
<ul style="list-style-type: none"> • at rotary coding switch on switch position 12 	39.8 A
<ul style="list-style-type: none"> • at rotary coding switch on switch position 13 	41.6 A
<ul style="list-style-type: none"> • at rotary coding switch on switch position 14 	43.4 A
<ul style="list-style-type: none"> • at rotary coding switch on switch position 15 	45.2 A
<ul style="list-style-type: none"> • at rotary coding switch on switch position 16 	47 A
<ul style="list-style-type: none"> • minimum 	20 A
adjustable motor current	
<ul style="list-style-type: none"> • for inside-delta circuit at rotary coding switch on switch position 1 	34.6 A
<ul style="list-style-type: none"> • for inside-delta circuit at rotary coding switch on switch position 2 	37.8 A
<ul style="list-style-type: none"> • for inside-delta circuit at rotary coding switch on switch position 3 	40.9 A
<ul style="list-style-type: none"> • for inside-delta circuit at rotary coding switch on switch position 4 	44 A
<ul style="list-style-type: none"> • for inside-delta circuit at rotary coding switch on switch position 5 	47.1 A
<ul style="list-style-type: none"> • for inside-delta circuit at rotary coding switch on switch position 6 	50.2 A
<ul style="list-style-type: none"> • for inside-delta circuit at rotary coding switch on switch position 7 	53.3 A
<ul style="list-style-type: none"> • for inside-delta circuit at rotary coding switch on switch position 8 	56.5 A
<ul style="list-style-type: none"> • for inside-delta circuit at rotary coding switch on switch position 9 	59.6 A
<ul style="list-style-type: none"> • for inside-delta circuit at rotary coding switch on switch position 10 	62.7 A
<ul style="list-style-type: none"> • for inside-delta circuit at rotary coding switch on switch position 11 	65.8 A
<ul style="list-style-type: none"> • for inside-delta circuit at rotary coding switch on switch position 12 	68.9 A
<ul style="list-style-type: none"> • for inside-delta circuit at rotary coding switch on switch position 13 	72.1 A
<ul style="list-style-type: none"> • for inside-delta circuit at rotary coding switch on switch position 14 	75.2 A
<ul style="list-style-type: none"> • for inside-delta circuit at rotary coding switch on switch position 15 	78.3 A
<ul style="list-style-type: none"> • for inside-delta circuit at rotary coding switch on switch position 16 	81.4 A
<ul style="list-style-type: none"> • at inside-delta circuit minimum 	34.6 A
minimum load [%]	15 %; Relative to smallest settable le
power loss [W] for rated value of the current at AC	
<ul style="list-style-type: none"> • at 40 °C after startup 	26 W
<ul style="list-style-type: none"> • at 50 °C after startup 	24 W

<ul style="list-style-type: none"> at 60 °C after startup 	23 W
power loss [W] at AC at current limitation 350 %	
<ul style="list-style-type: none"> at 40 °C during startup 	606 W
<ul style="list-style-type: none"> at 50 °C during startup 	522 W
<ul style="list-style-type: none"> at 60 °C during startup 	438 W
Control circuit/ Control	
type of voltage of the control supply voltage	AC
control supply voltage at AC	
<ul style="list-style-type: none"> at 50 Hz 	110 ... 250 V
<ul style="list-style-type: none"> at 60 Hz 	110 ... 250 V
relative negative tolerance of the control supply voltage at AC at 50 Hz	-15 %
relative positive tolerance of the control supply voltage at AC at 50 Hz	10 %
relative negative tolerance of the control supply voltage at AC at 60 Hz	-15 %
relative positive tolerance of the control supply voltage at AC at 60 Hz	10 %
control supply voltage frequency	50 ... 60 Hz
relative negative tolerance of the control supply voltage frequency	-10 %
relative positive tolerance of the control supply voltage frequency	10 %
control supply current in standby mode rated value	30 mA
holding current in bypass operation rated value	75 mA
locked-rotor current at close of bypass contact maximum	2.5 A
inrush current peak at application of control supply voltage maximum	12.2 A
duration of inrush current peak at application of control supply voltage	2.2 ms
design of the overvoltage protection	Varistor
design of short-circuit protection for control circuit	4 A gG fuse (I _{cu} =1 kA), 6 A quick-acting fuse (I _{cu} =1 kA), C1 miniature circuit breaker (I _{cu} = 600 A), C6 miniature circuit breaker (I _{cu} = 300 A); Is not part of scope of supply
Inputs/ Outputs	
number of digital inputs	1
number of digital outputs	3
<ul style="list-style-type: none"> not parameterizable 	2
digital output version	2 normally-open contacts (NO) / 1 changeover contact (CO)
number of analog outputs	1
switching capacity current of the relay outputs	
<ul style="list-style-type: none"> at AC-15 at 250 V rated value 	3 A
<ul style="list-style-type: none"> at DC-13 at 24 V rated value 	1 A
Installation/ mounting/ dimensions	
mounting position	+/- 10° rotation possible and can be tilted forward or backward on vertical mounting surface
fastening method	screw fixing
height	306 mm
width	185 mm
depth	203 mm
required spacing with side-by-side mounting	
<ul style="list-style-type: none"> forwards 	10 mm
<ul style="list-style-type: none"> backwards 	0 mm
<ul style="list-style-type: none"> upwards 	100 mm
<ul style="list-style-type: none"> downwards 	75 mm
<ul style="list-style-type: none"> at the side 	5 mm
weight without packaging	5.2 kg
Connections/ Terminals	
type of electrical connection	
<ul style="list-style-type: none"> for main current circuit 	box terminal
<ul style="list-style-type: none"> for control circuit 	screw-type terminals

width of connection bar maximum	25 mm
type of connectable conductor cross-sections	
<ul style="list-style-type: none"> • for main contacts for box terminal using the front clamping point solid 	1x (2.5 ... 16 mm ²)
<ul style="list-style-type: none"> • for main contacts for box terminal using the front clamping point finely stranded with core end processing 	1x (2.5 ... 50 mm ²)
<ul style="list-style-type: none"> • for main contacts for box terminal using the front clamping point stranded 	1x (10 ... 70 mm ²)
<ul style="list-style-type: none"> • at AWG cables for main contacts for box terminal using the front clamping point 	1x (10 ... 2/0)
<ul style="list-style-type: none"> • for main contacts for box terminal using the back clamping point solid 	1x (2.5 ... 16 mm ²)
<ul style="list-style-type: none"> • at AWG cables for main contacts for box terminal using the back clamping point 	1x (10 ... 2/0)
<ul style="list-style-type: none"> • for main contacts for box terminal using both clamping points solid 	2x (2.5 ... 16 mm ²)
<ul style="list-style-type: none"> • for main contacts for box terminal using both clamping points finely stranded with core end processing 	2x (2.5 ... 35 mm ²)
<ul style="list-style-type: none"> • for main contacts for box terminal using both clamping points stranded 	2x (6 ... 16 mm ²), 2x (10 ... 50 mm ²)
<ul style="list-style-type: none"> • for main contacts for box terminal using the back clamping point finely stranded with core end processing 	1x (2.5 ... 50 mm ²)
<ul style="list-style-type: none"> • for main contacts for box terminal using the back clamping point stranded 	1x (10 ... 70 mm ²)
type of connectable conductor cross-sections	
<ul style="list-style-type: none"> • for control circuit solid 	1x (0.5 ... 4.0 mm ²), 2x (0.5 ... 2.5 mm ²)
<ul style="list-style-type: none"> • for control circuit finely stranded with core end processing 	1x (0.5 ... 2.5 mm ²), 2x (0.5 ... 1.5 mm ²)
<ul style="list-style-type: none"> • at AWG cables for control circuit solid 	1x (20 ... 12), 2x (20 ... 14)
wire length	
<ul style="list-style-type: none"> • between soft starter and motor maximum 	800 m
<ul style="list-style-type: none"> • at the digital inputs at AC maximum 	100 m
tightening torque	
<ul style="list-style-type: none"> • for main contacts with screw-type terminals 	4.5 ... 6 N·m
<ul style="list-style-type: none"> • for auxiliary and control contacts with screw-type terminals 	0.8 ... 1.2 N·m
tightening torque [lbf·in]	
<ul style="list-style-type: none"> • for main contacts with screw-type terminals 	40 ... 53 lbf·in
<ul style="list-style-type: none"> • for auxiliary and control contacts with screw-type terminals 	7 ... 10.3 lbf·in
Ambient conditions	
installation altitude at height above sea level maximum	5 000 m; Derating as of 1000 m, see catalog
ambient temperature	
<ul style="list-style-type: none"> • during operation 	-25 ... +60 °C; Please observe derating at temperatures of 40 °C or above
<ul style="list-style-type: none"> • during storage and transport 	-40 ... +80 °C
environmental category	
<ul style="list-style-type: none"> • during operation according to IEC 60721 	3K6 (no ice formation, only occasional condensation), 3C3 (no salt mist), 3S2 (sand must not get into the devices), 3M6
<ul style="list-style-type: none"> • during storage according to IEC 60721 	1K6 (only occasional condensation), 1C2 (no salt mist), 1S2 (sand must not get inside the devices), 1M4
<ul style="list-style-type: none"> • during transport according to IEC 60721 	2K2, 2C1, 2S1, 2M2 (max. fall height 0.3 m)
EMC emitted interference	acc. to IEC 60947-4-2: Class A
Communication/ Protocol	
communication module is supported	
<ul style="list-style-type: none"> • PROFINET standard 	Yes
<ul style="list-style-type: none"> • EtherNet/IP 	Yes
<ul style="list-style-type: none"> • Modbus RTU 	Yes
<ul style="list-style-type: none"> • Modbus TCP 	Yes
<ul style="list-style-type: none"> • PROFIBUS 	Yes
UL/CSA ratings	

manufacturer's article number <ul style="list-style-type: none"> ● of circuit breaker <ul style="list-style-type: none"> — usable for Standard Faults at 460/480 V according to UL — usable for High Faults at 460/480 V according to UL — usable for Standard Faults at 460/480 V at inside-delta circuit according to UL — usable for High Faults at 460/480 V at inside-delta circuit according to UL — usable for Standard Faults at 575/600 V according to UL — usable for Standard Faults at 575/600 V at inside-delta circuit according to UL ● of the fuse <ul style="list-style-type: none"> — usable for Standard Faults up to 575/600 V according to UL — usable for High Faults up to 575/600 V according to UL — usable for Standard Faults at inside-delta circuit up to 575/600 V according to UL — usable for High Faults at inside-delta circuit up to 575/600 V according to UL 	Siemens type: 3RV2742, max. 70 A or 3VA51, max. 90 A; Iq = 5 kA Siemens type: 3VA51, max. 60 A; Iq max = 65 kA Siemens type: 3VA51, max. 90 A; Iq = 5 kA Siemens type: 3VA51, max. 60 A; Iq max = 65 kA Siemens type: 3RV2742, max. 70 A or 3VA51, max. 90 A; Iq = 5 kA Siemens type: 3VA51, max. 90 A; Iq = 5 kA Type: Class RK5 / K5, max. 175 A; Iq = 5 kA Type: Class J / L, max. 175 A; Iq = 100 kA Type: Class RK5 / K5, max. 175 A; Iq = 5 kA Type: Class J / L, max. 175 A; Iq = 100 kA	
operating power [hp] for 3-phase motors <ul style="list-style-type: none"> ● at 200/208 V at 50 °C rated value ● at 220/230 V at 50 °C rated value ● at 460/480 V at 50 °C rated value ● at 200/208 V at inside-delta circuit at 50 °C rated value ● at 220/230 V at inside-delta circuit at 50 °C rated value ● at 460/480 V at inside-delta circuit at 50 °C rated value 	10 hp 10 hp 30 hp 20 hp 25 hp 50 hp	
contact rating of auxiliary contacts according to UL	R300-B300	
Safety related data		
protection class IP on the front according to IEC 60529	IP00; IP20 with cover	
touch protection on the front according to IEC 60529	finger-safe, for vertical contact from the front with cover	
electromagnetic compatibility	in accordance with IEC 60947-4-2	
Certificates/ approvals		
General Product Approval	EMC	
  Confirmation   		
Declaration of Conformity	Test Certificates	Marine / Shipping
 	Type Test Certificates/Test Report	  
Marine / Shipping	other	
  Confirmation		

Further information

Information- and Downloadcenter (Catalogs, Brochures,...)

<https://www.siemens.com/ic10>

Industry Mall (Online ordering system)

<https://mall.industry.siemens.com/mall/en/en/Catalog/product?mlfb=3RW5224-1AC14>

Cax online generator

<http://support.automation.siemens.com/WW/CAXorder/default.aspx?lang=en&mlfb=3RW5224-1AC14>

Service&Support (Manuals, Certificates, Characteristics, FAQs,...)

<https://support.industry.siemens.com/cs/ww/en/ps/3RW5224-1AC14>

Image database (product images, 2D dimension drawings, 3D models, device circuit diagrams, EPLAN macros, ...)

http://www.automation.siemens.com/bilddb/cax_de.aspx?mlfb=3RW5224-1AC14&lang=en

Characteristic: Tripping characteristics, I^t, Let-through current

<https://support.industry.siemens.com/cs/ww/en/ps/3RW5224-1AC14/char>

Characteristic: Installation altitude

<http://www.automation.siemens.com/bilddb/index.aspx?view=Search&mlfb=3RW5224-1AC14&objecttype=14&gridview=view1>

Simulation Tool for Soft Starters (STS)

<https://support.industry.siemens.com/cs/ww/en/view/101494917>

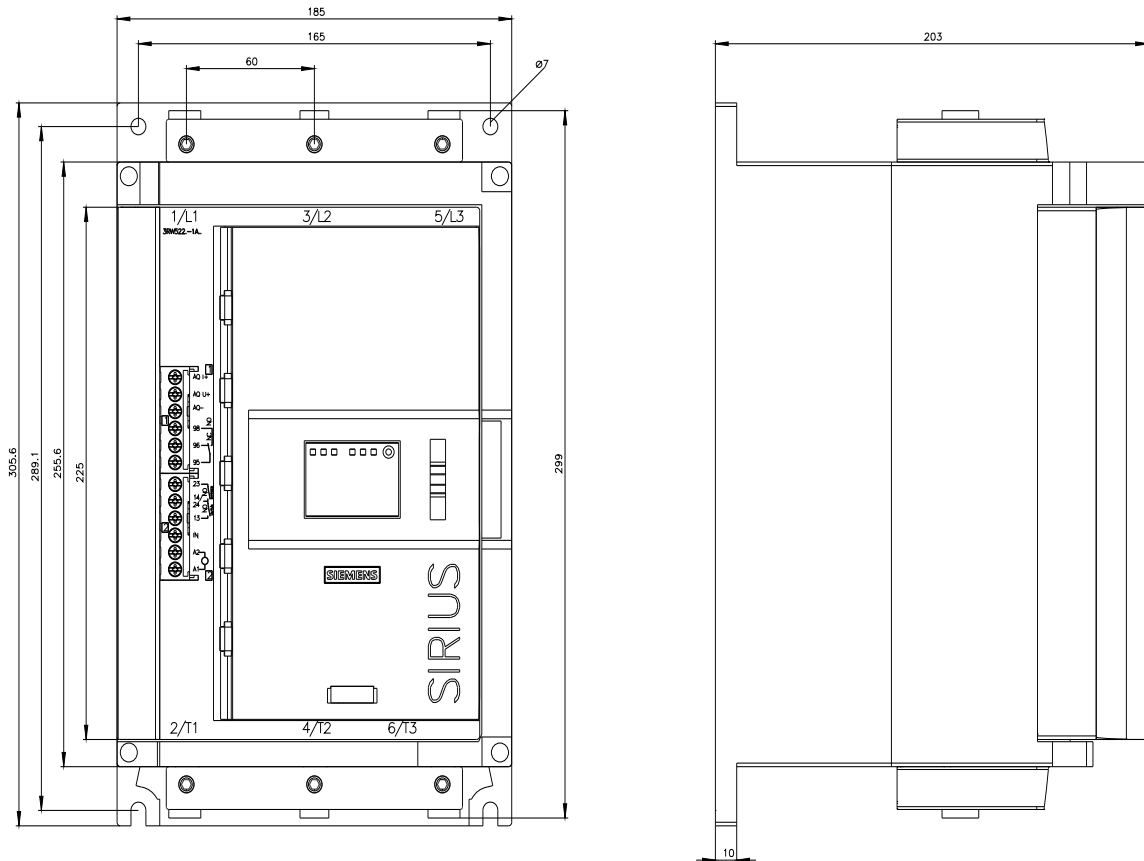

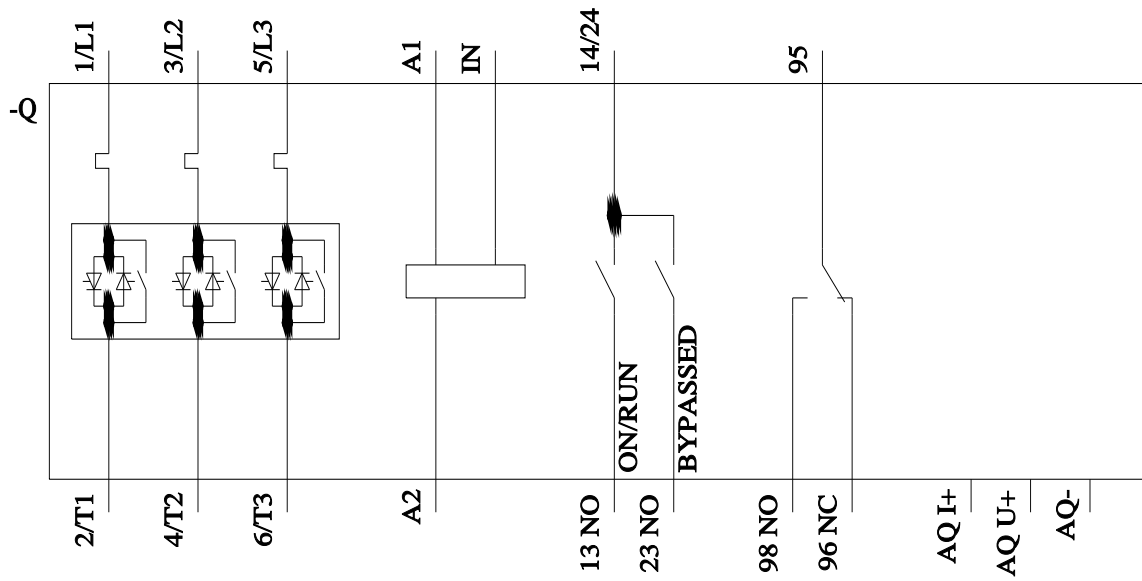

last modified:

4/10/2022 

