

PLC-RPT- 24UC/21-21AU/MS - Relay Module



2910526

<https://www.phoenixcontact.com/pc/products/2910526>

Please be informed that the data shown in this PDF document is generated from our online catalog. Please find the complete data in the user documentation. Our general terms of use for downloads are valid.



PLC-INTERFACE, consisting of a relay base and pluggable multilayer gold contact relay with manual operation, integrated status LED, Push-in connection, 2 changeover contacts, Bridge rectifier, Input voltage: 24 V AC/DC

Commercial data

| | |
|--------------------------------------|--------------------------------|
| Item number | 2910526 |
| Packing unit | 10 pc |
| Minimum order quantity | 1 pc |
| Note | Made to order (non-returnable) |
| Product key | CK623D |
| Catalog page | Page 369 (C-5-2019) |
| GTIN | 4055626486772 |
| Weight per piece (including packing) | 73.5 g |
| Weight per piece (excluding packing) | 64 g |
| Customs tariff number | 85364190 |
| Country of origin | DE |

PLC-RPT- 24UC/21-21AU/MS - Relay Module



2910526

<https://www.phoenixcontact.com/pc/products/2910526>

Technical data

Product properties

| | |
|-------------------------|---------------------------|
| Product type | Relay Module |
| Product family | PLC-INTERFACE |
| Application | Palm switch |
| Operating mode | 100% operating factor |
| Mechanical service life | 5x 10 ⁶ cycles |

Insulation characteristics

| | |
|------------|------------------|
| Insulation | Basic insulation |
|------------|------------------|

Insulation characteristics: Standards/regulations

| | |
|----------------------|------------------|
| Insulation | Basic insulation |
| Overvoltage category | III |
| Pollution degree | 2 |

Electrical properties

| | |
|--|---|
| Maximum power dissipation for nominal condition | 0.44 W |
| Test voltage (Winding/contact) | 4 kV AC (50 Hz, 1 min., winding/contact) |
| Test voltage (Changeover contact/changeover contact) | 2.5 V AC (50 Hz, 1 min., changeover contact/changeover contact) |

Standards/regulations

| | |
|--------------------------|----------|
| Rated insulation voltage | 250 V AC |
| Rated surge voltage | 6 kV |

Input data

Coil side

| | |
|--------------------------------|---------------------------------------|
| Nominal input voltage U_N | 24 V AC/DC |
| Input voltage range | 20.6 V AC/DC ... 33.6 V AC/DC (20 °C) |
| Drive and function | monostable |
| Drive (polarity) | polarized |
| Typical input current at U_N | 18 mA |
| Typical response time | 3 ms ... 15 ms |
| Typical release time range | 3 ms ... 15 ms |
| Coil voltage | 24 V DC |
| Protective circuit | Bridge rectifier; Bridge rectifier |
| Operating voltage display | Yellow LED |

Output data

Switching

| | |
|------------------------|-----------------------|
| Contact switching type | 2 changeover contacts |
| Type of switch contact | Single contact |

PLC-RPT- 24UC/21-21AU/MS - Relay Module



2910526

<https://www.phoenixcontact.com/pc/products/2910526>

| | |
|-----------------------------|------------------------|
| Contact material | AgNi, hard gold-plated |
| Maximum switching voltage | 30 V AC |
| | 36 V DC |
| Minimum switching voltage | 12 V (1 mA) |
| Limiting continuous current | 50 mA |
| Maximum inrush current | 50 mA |
| Min. switching current | 1 mA (12 V) |

Switching: when the gold layer is destroyed

| | |
|---------------------------------------|--|
| Note | the following values are applicable if a gold layer is destroyed |
| Maximum switching voltage | 250 V AC/DC |
| Minimum switching voltage | 12 V |
| Limiting continuous current | 6 A |
| Maximum inrush current | 12 A (20 ms) |
| Min. switching current | 10 mA |
| Interrupting rating (ohmic load) max. | 192 W (24 V DC) |
| | 62 W (48 V DC) |
| | 42 W (60 V DC) |
| | 55 W (110 V DC) |
| | 66 W (220 V DC) |
| | 2000 VA (250 V AC) |
| Switching capacity | 1 A (24 V, DC13) |
| | 1.5 A (230 V, AC15) |

Connection data

| | |
|----------------------------------|--|
| Connection method | Push-in connection |
| Stripping length | 10 mm |
| Conductor cross section rigid | 0.14 mm ² ... 2.5 mm ² |
| Conductor cross section flexible | 0.14 mm ² ... 2.5 mm ² |
| | 0.2 mm ² ... 2.5 mm ² (Single ferrule) |
| | 2x 0.5 mm ² ... 1 mm ² (TWIN ferrule) |
| Conductor cross section AWG | 26 ... 14 |

Dimensions

| | |
|--------|--------|
| Width | 14 mm |
| Height | 80 mm |
| Depth | 104 mm |

Material specifications

| | |
|--|-----------------|
| Color | gray (RAL 7042) |
| Flammability rating according to UL 94 | V0 (Housing) |

Environmental and real-life conditions

PLC-RPT- 24UC/21-21AU/MS - Relay Module



2910526

<https://www.phoenixcontact.com/pc/products/2910526>

Ambient conditions

| | |
|--|--------------------------------|
| Degree of protection (Relay) | RT II (Relay) |
| Degree of protection (Relay base) | IP20 (Relay base) |
| Degree of protection (Installation location) | ≥ IP54 (Installation location) |
| Ambient temperature (operation) | -40 °C ... 60 °C |
| Ambient temperature (storage/transport) | -40 °C ... 85 °C |
| Altitude | ≤ 2000 m |

Approvals

CE

| | |
|-------------|--------------|
| Certificate | CE-compliant |
|-------------|--------------|

UKCA

| | |
|-------------|----------------|
| Certificate | UKCA-compliant |
|-------------|----------------|

UL, USA

| | |
|----------------|-------------------|
| Identification | UL 508 |
| | UL 508 Recognized |

UL, USA/Canada

| | |
|----------------|-------------------|
| Identification | UL 508 |
| | UL 508 Recognized |

Shipbuilding approval

| | |
|-------------|------------|
| Certificate | TAE0000196 |
|-------------|------------|

Corrosive gas test

| | |
|----------------|----------------------------|
| Identification | ISA-S71.04. G3 Harsh Group |
| | EN 60068-2-60 |

DNV GL data

| | |
|-------------|---|
| Temperature | D |
| Humidity | A |
| Vibration | B/C |
| EMC | B |
| Enclosure | Required protection according to the Rules shall be provided upon installation on board |

EMC data

| | |
|-------------------------------|--|
| Low Voltage Directive | Conformance with Low Voltage Directive |
| Electromagnetic compatibility | Conformance with EMC directive |

Standards and regulations

Standards/regulations

| | |
|-----------------------|----------|
| Standards/regulations | EN 50178 |
|-----------------------|----------|

PLC-RPT- 24UC/21-21AU/MS - Relay Module



2910526

<https://www.phoenixcontact.com/pc/products/2910526>

Mounting

| | |
|-----------------------|---------------------------|
| Mounting type | DIN rail mounting |
| Assembly instructions | in rows with zero spacing |
| Mounting position | any |

Drawings

Diagram

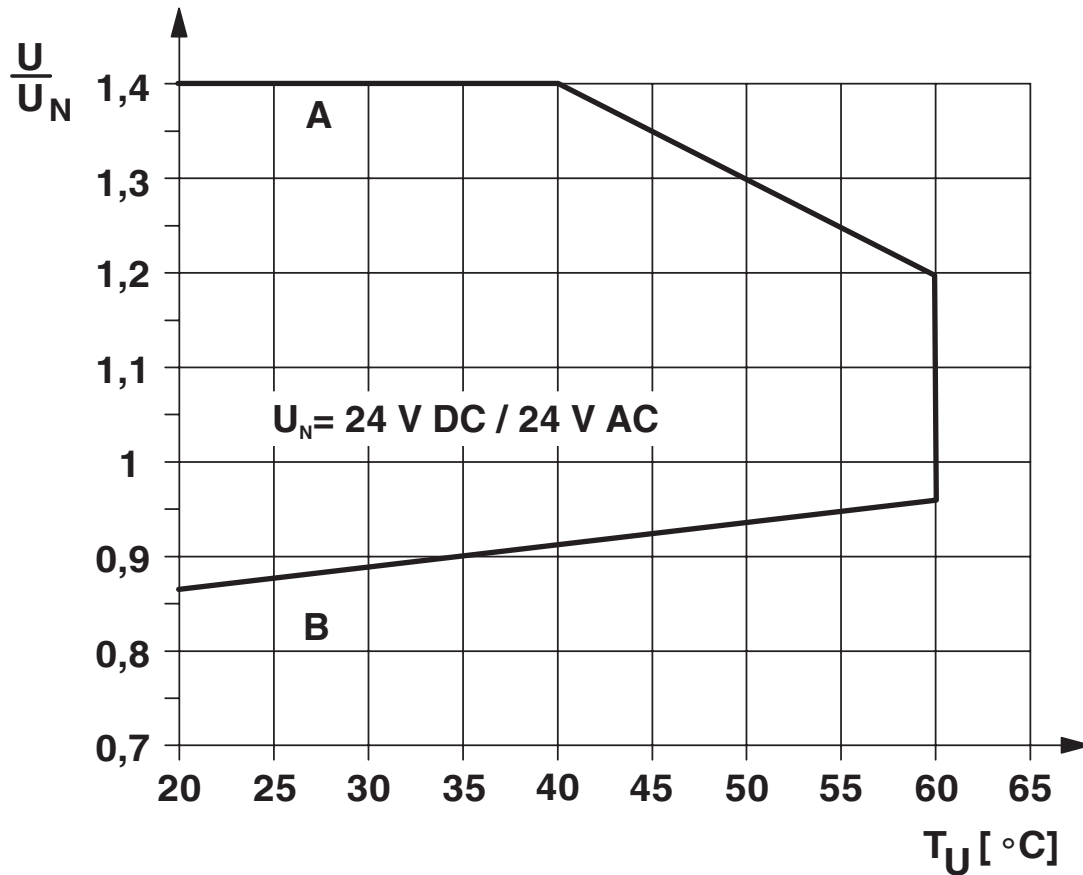

Curve A

Maximum permissible continuous voltage U_{max} with limiting continuous current on the contact side (see relevant technical data)

Curve B

Minimum permissible operate voltage U_{op} after pre-excitation (see relevant technical data)

2910526

<https://www.phoenixcontact.com/pc/products/2910526>

Diagram

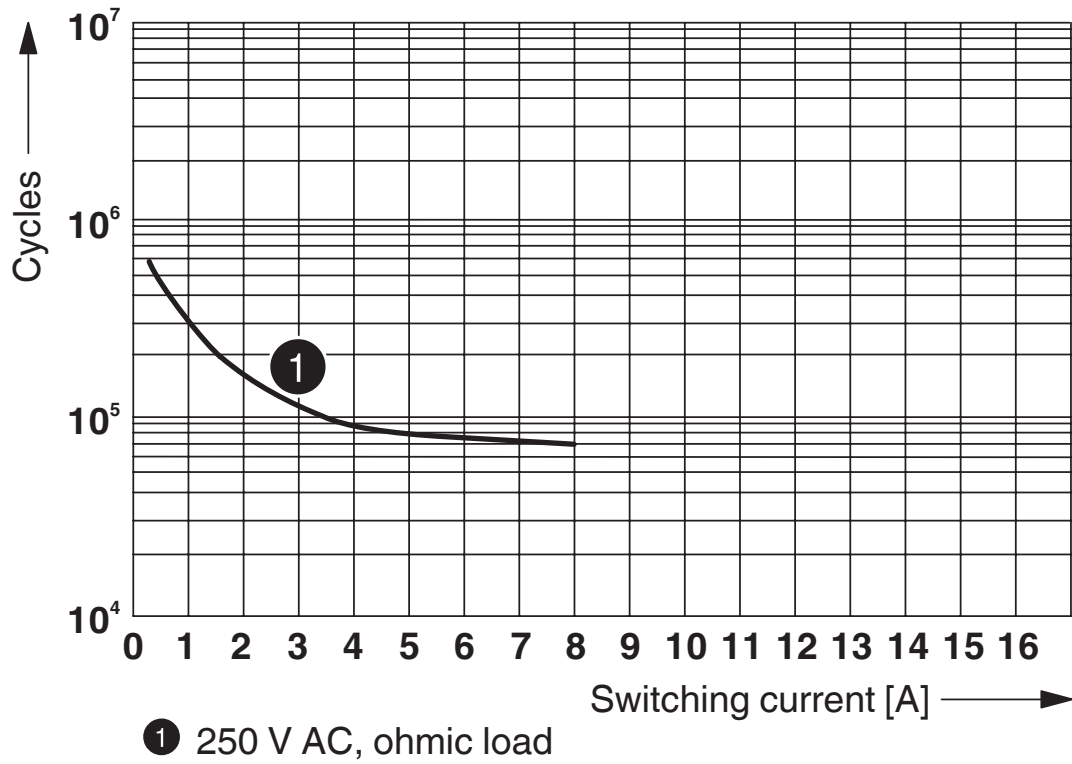

Electrical service life

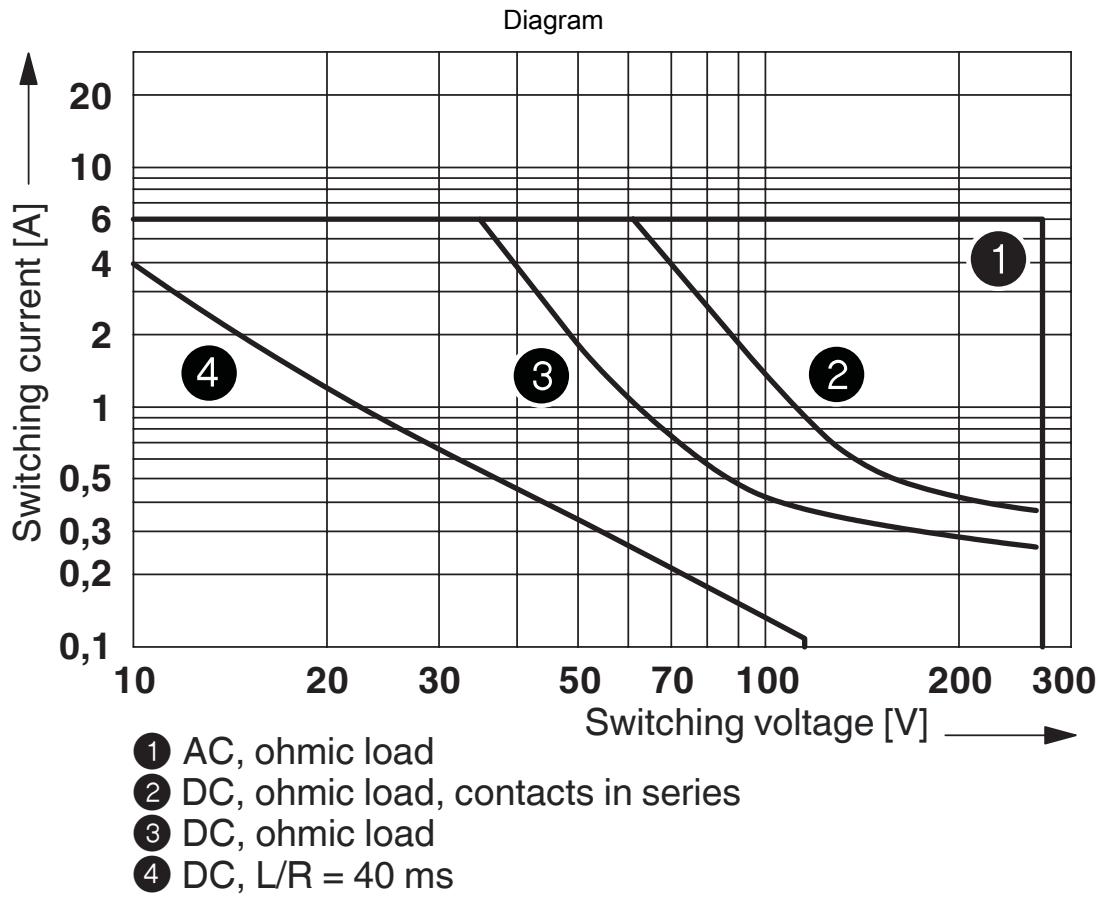

Interrupting rating

Diagram

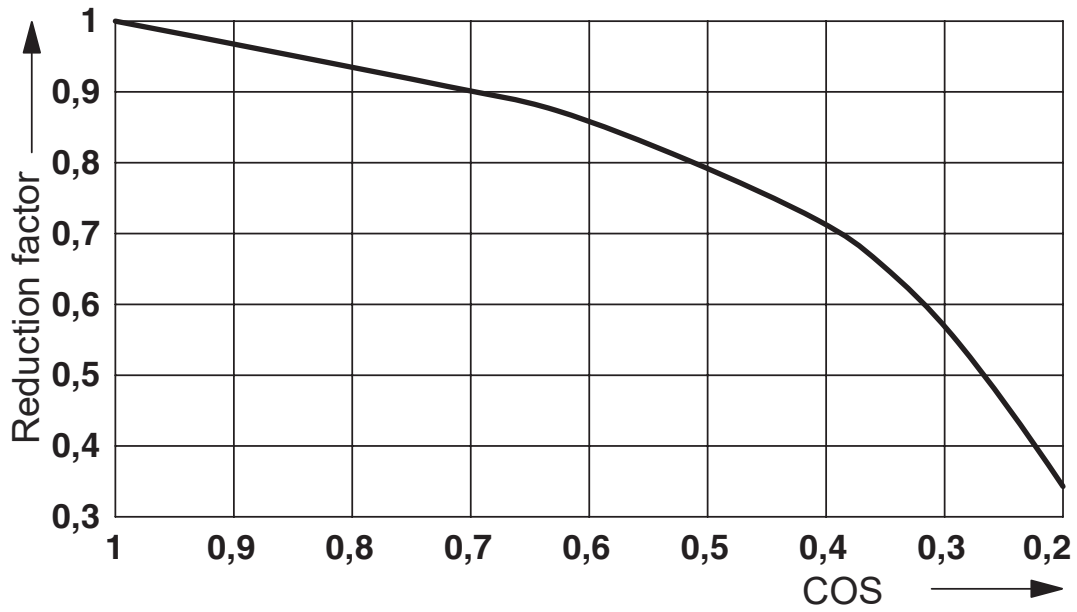

Service life reduction factor

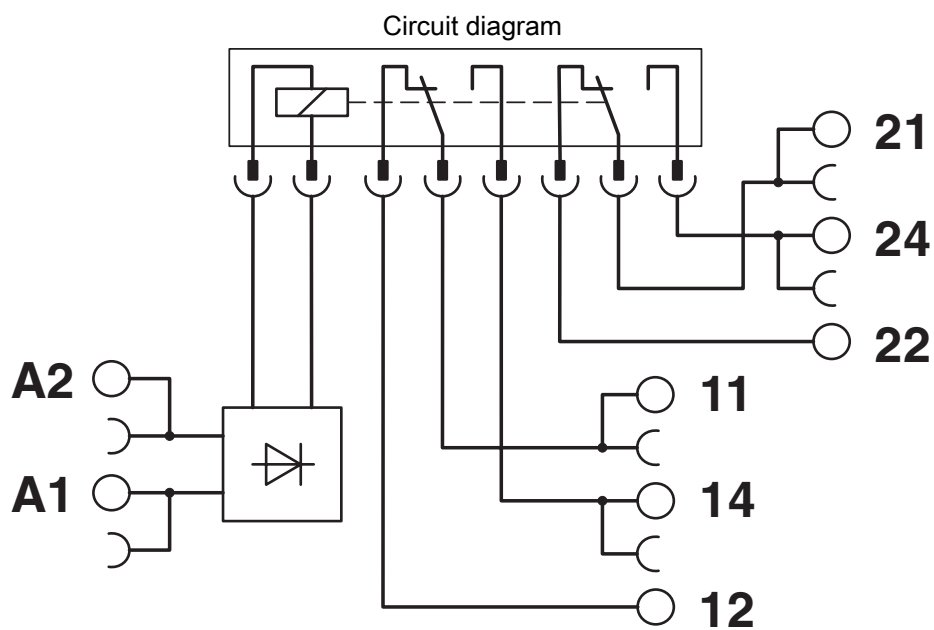

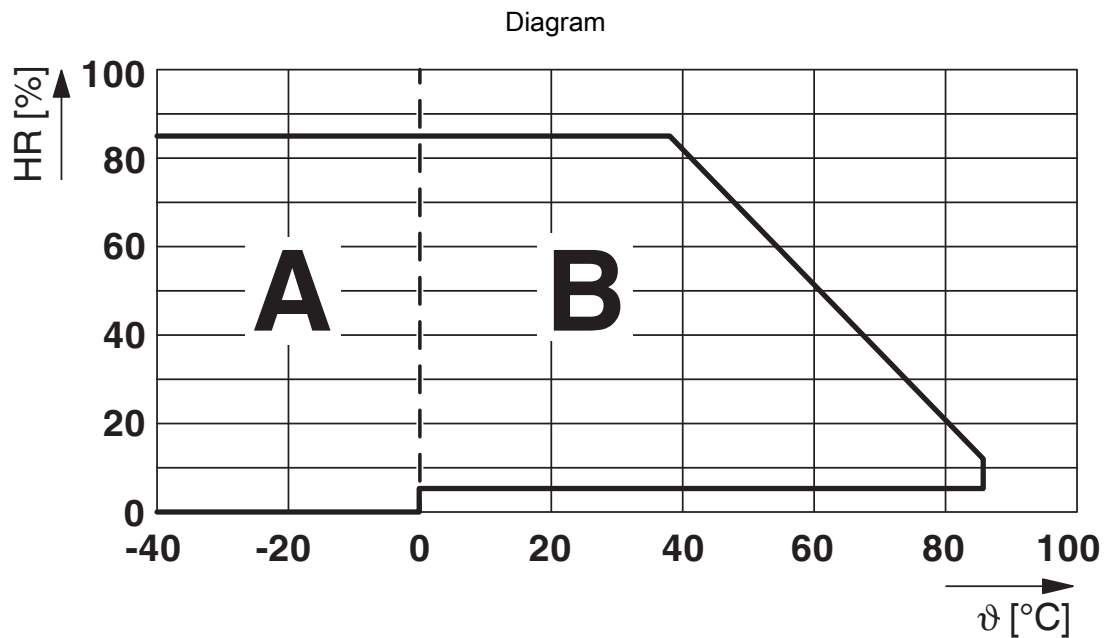

Permissible humidity for operation and storage.

The maximum permissible ambient temperature as specified in the data sheet must be observed.

Area A: Ice buildup at ambient temperatures $\leq 0^\circ\text{C}$ must be prevented

Area B: Condensation at ambient temperatures $> 0^\circ\text{C}$ must be prevented

On 30 full days that are naturally distributed across an entire year, a humidity level of 95% is permissible at an ambient temperature $\leq 25^\circ\text{C}$.

PLC-RPT- 24UC/21-21AU/MS - Relay Module



2910526

<https://www.phoenixcontact.com/pc/products/2910526>

Approvals

To download certificates, visit the product detail page: <https://www.phoenixcontact.com/pc/products/2910526>



cUL Recognized
Approval ID: FILE E 238705



UL Recognized
Approval ID: FILE E 238705



EAC
Approval ID: TR_TS_D_00573_c



DNV GL
Approval ID: TAE0000196



EAC
Approval ID: RU*C-DE.*08.B.00010



UL Listed
Approval ID: FILE E 172140



cUL Listed
Approval ID: FILE E 172140



cULus Listed
Approval ID: E140324

cULus Recognized

cULus Listed

PLC-RPT- 24UC/21-21AU/MS - Relay Module



2910526

<https://www.phoenixcontact.com/pc/products/2910526>

Classifications

ECLASS

| | |
|-------------|----------|
| ECLASS-11.0 | 27371601 |
| ECLASS-12.0 | 27371601 |
| ECLASS-13.0 | 27371601 |

ETIM

| | |
|----------|----------|
| ETIM 9.0 | EC001437 |
|----------|----------|

UNSPSC

| | |
|-------------|----------|
| UNSPSC 21.0 | 39122300 |
|-------------|----------|

PLC-RPT- 24UC/21-21AU/MS - Relay Module



2910526

<https://www.phoenixcontact.com/pc/products/2910526>

Environmental product compliance

| | |
|------------|--|
| REACH SVHC | Lead 7439-92-1 |
| | Hexahydromethylphthalic anhydride |
| China RoHS | Environmentally Friendly Use Period = 50 years |
| | For information on hazardous substances, refer to the manufacturer's declaration available under "Downloads" |

PLC-RPT- 24UC/21-21AU/MS - Relay Module



2910526

<https://www.phoenixcontact.com/pc/products/2910526>

Accessories

i Note: Applying some accessories below might limit this product.

FBST 500-PLC RD - Continuous plug-in bridge

2966786

<https://www.phoenixcontact.com/pc/products/2966786>



Continuous plug-in bridge, length: 500 mm, color: red

i Max. current carrying capacity: 32 A

FBST 500-PLC BU - Continuous plug-in bridge

2966692

<https://www.phoenixcontact.com/pc/products/2966692>

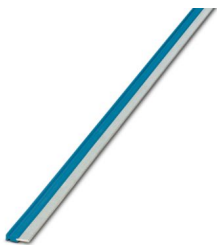

Continuous plug-in bridge, length: 500 mm, color: blue

i Max. current carrying capacity: 32 A

PLC-RPT- 24UC/21-21AU/MS - Relay Module

2910526

<https://www.phoenixcontact.com/pc/products/2910526>



FBST 500-PLC GY - Continuous plug-in bridge

2966838

<https://www.phoenixcontact.com/pc/products/2966838>



Continuous plug-in bridge, length: 500 mm, color: gray

 Max. current carrying capacity: 32 A

FBST 6-PLC RD - Single plug-in bridge

2966236

<https://www.phoenixcontact.com/pc/products/2966236>

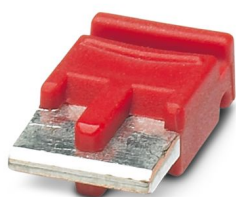

Single plug-in bridge, number of positions: 2, length: 6 mm, color: red

 Max. current carrying capacity: 6 A

PLC-RPT- 24UC/21-21AU/MS - Relay Module



2910526

<https://www.phoenixcontact.com/pc/products/2910526>

FBST 6-PLC BU - Single plug-in bridge

2966812

<https://www.phoenixcontact.com/pc/products/2966812>

Single plug-in bridge, number of positions: 2, length: 6 mm, color: blue

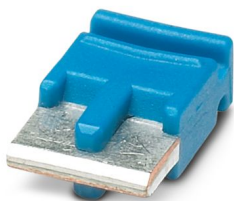

 Max. current carrying capacity: 6 A

FBST 6-PLC GY - Single plug-in bridge

2966825

<https://www.phoenixcontact.com/pc/products/2966825>

Single plug-in bridge, number of positions: 2, length: 6 mm, color: gray

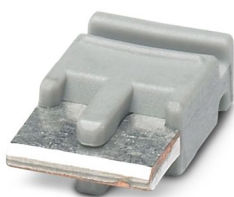

 Max. current carrying capacity: 6 A

PLC-RPT- 24UC/21-21AU/MS - Relay Module



2910526

<https://www.phoenixcontact.com/pc/products/2910526>

FBST 8-PLC GY - Single plug-in bridge

2967688

<https://www.phoenixcontact.com/pc/products/2967688>

Single plug-in bridge, number of positions: 2, length: 8 mm, color: gray



 Max. current carrying capacity: 6 A

FBST 14-PLC BK - Single plug-in bridge

2967691

<https://www.phoenixcontact.com/pc/products/2967691>

Single plug-in bridge, number of positions: 2, length: 14 mm, color: black



 Max. current carrying capacity: 10 A

PLC-RPT- 24UC/21-21AU/MS - Relay Module



2910526

<https://www.phoenixcontact.com/pc/products/2910526>

ZB 10:UNBEDRUCKT - Zack marker strip

1053001

<https://www.phoenixcontact.com/pc/products/1053001>



Zack marker strip, Strip, white, unlabeled, can be labeled with: PLOTMARK, CMS-P1-PLOTTER, mounting type: snapped, for terminal block width: 10.2 mm, lettering field size: 10.5 x 10.15 mm, Number of individual labels: 10

ZB 10 CUS - Zack marker strip

0824941

<https://www.phoenixcontact.com/pc/products/0824941>



Zack marker strip, can be ordered: Strip, white, labeled according to customer specifications, mounting type: snap into tall marker groove, for terminal block width: 10.2 mm, lettering field size: 10,15 x 10,5 mm, Number of individual labels: 10

PLC-RPT- 24UC/21-21AU/MS - Relay Module



2910526

<https://www.phoenixcontact.com/pc/products/2910526>

ZB10,LGS:FORTL.ZAHLEN - Zack marker strip

1053014

<https://www.phoenixcontact.com/pc/products/1053014>



Zack marker strip, Strip, white, labeled, can be labeled with: CMS-P1-PLOTTER, printed horizontally: consecutive numbers 1 ... 10, 11 ... 20, etc. up to 91 ... 100, mounting type: snapped, for terminal block width: 10.2 mm, lettering field size: 10,15 x 10,5 mm, Number of individual labels: 10

ZB10,QR:FORTL.ZAHLEN - Zack marker strip

1053027

<https://www.phoenixcontact.com/pc/products/1053027>



Zack marker strip, Strip, white, labeled, can be labeled with: CMS-P1-PLOTTER, Printed vertically: consecutive numbers 1 ... 10, 11 ... 20, etc. up to 91 ... 100, mounting type: snapped, for terminal block width: 10.2 mm, lettering field size: 10,15 x 10,5 mm, Number of individual labels: 10

PLC-RPT- 24UC/21-21AU/MS - Relay Module



2910526

<https://www.phoenixcontact.com/pc/products/2910526>

ZB10,LGS:L1-N,PE - Marker for terminal blocks

1053412

<https://www.phoenixcontact.com/pc/products/1053412>



Marker for terminal blocks, Strip, white, labeled, can be labeled with: CMS-P1-PLOTTER, horizontal: L1, L2, L3, N, PE, L1, L2, L3, N, PE, mounting type: snapped, for terminal block width: 10.2 mm, lettering field size: 10,15 x 10,5 mm, Number of individual labels: 10

ZB10,LGS:U-N - Marker for terminal blocks

1053438

<https://www.phoenixcontact.com/pc/products/1053438>



Marker for terminal blocks, Strip, white, labeled, can be labeled with: CMS-P1-PLOTTER, horizontal: U, V, W, N, GND, U, V, W, N, GND, mounting type: snapped, for terminal block width: 10.2 mm, lettering field size: 10,15 x 10,5 mm, Number of individual labels: 10

PLC-RPT- 24UC/21-21AU/MS - Relay Module



2910526

<https://www.phoenixcontact.com/pc/products/2910526>

UC-TM 10 - Marker for terminal blocks

0818069

<https://www.phoenixcontact.com/pc/products/0818069>



Marker for terminal blocks, Sheet, white, unlabeled, can be labeled with: BLUEMARK ID COLOR, BLUEMARK ID, BLUEMARK CLED, PLOTMARK, CMS-P1-PLOTTER, mounting type: snapped, for terminal block width: 10.2 mm, lettering field size: 9.6 x 10.5 mm, Number of individual labels: 48

UC-TM 10 CUS - Marker for terminal blocks

0824605

<https://www.phoenixcontact.com/pc/products/0824605>



Marker for terminal blocks, can be ordered: by sheet, white, labeled according to customer specifications, mounting type: snap into tall marker groove, for terminal block width: 10.2 mm, lettering field size: 9.6 x 10.5 mm, Number of individual labels: 48

PLC-RPT- 24UC/21-21AU/MS - Relay Module



2910526

<https://www.phoenixcontact.com/pc/products/2910526>

UCT-TM 10 - Marker for terminal blocks

0829142

<https://www.phoenixcontact.com/pc/products/0829142>



Marker for terminal blocks, Sheet, white, unlabeled, can be labeled with: TOPMARK NEO, TOPMARK LASER, BLUEMARK ID COLOR, BLUEMARK ID, BLUEMARK CLED, THERMOMARK PRIME, THERMOMARK CARD 2.0, THERMOMARK CARD, mounting type: snapped, for terminal block width: 10.2 mm, lettering field size: 8.9 x 9.6 mm, Number of individual labels: 36

UCT-TM 10 CUS - Marker for terminal blocks

0829623

<https://www.phoenixcontact.com/pc/products/0829623>



Marker for terminal blocks, can be ordered: by sheet, white, labeled according to customer specifications, mounting type: snap into tall marker groove, for terminal block width: 10.2 mm, lettering field size: 8.9 x 9.6 mm, Number of individual labels: 36

PLC-RPT- 24UC/21-21AU/MS - Relay Module



2910526

<https://www.phoenixcontact.com/pc/products/2910526>

ZB 12:UNPRINTED - Zack marker strip

0812120

<https://www.phoenixcontact.com/pc/products/0812120>

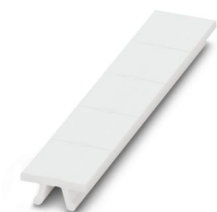

Zack marker strip, Strip, white, unlabeled, can be labeled with: PLOTMARK, CMS-P1-PLOTTER, mounting type: snapped, for terminal block width: 12.2 mm, lettering field size: 12 x 10.5 mm, Number of individual labels: 5

ZB 12 CUS - Zack marker strip

0824942

<https://www.phoenixcontact.com/pc/products/0824942>



Zack marker strip, can be ordered: Strip, white, labeled according to customer specifications, mounting type: snap into tall marker groove, for terminal block width: 12.2 mm, lettering field size: 10.5 x 12.15 mm, Number of individual labels: 5

PLC-RPT- 24UC/21-21AU/MS - Relay Module



2910526

<https://www.phoenixcontact.com/pc/products/2910526>

ZB 12,LGS:L1-N,PE - Zack marker strip

0812146

<https://www.phoenixcontact.com/pc/products/0812146>



Zack marker strip, Strip, white, labeled, printed horizontally: L1, L2, L3, N, PE, mounting type: snapped, for terminal block width: 12.2 mm, lettering field size: 10.5 x 12.15 mm, Number of individual labels: 5

UC-TM 12 - Marker for terminal blocks

0819194

<https://www.phoenixcontact.com/pc/products/0819194>



Marker for terminal blocks, Sheet, white, unlabeled, can be labeled with: BLUEMARK ID COLOR, BLUEMARK ID, BLUEMARK CLED, PLOTMARK, CMS-P1-PLOTTER, mounting type: snapped, for terminal block width: 12 mm, lettering field size: 11.45 x 10.5 mm, Number of individual labels: 40

PLC-RPT- 24UC/21-21AU/MS - Relay Module



2910526

<https://www.phoenixcontact.com/pc/products/2910526>

UC-TM 12 CUS - Marker for terminal blocks

0824613

<https://www.phoenixcontact.com/pc/products/0824613>



Marker for terminal blocks, can be ordered: by sheet, white, labeled according to customer specifications, mounting type: snap into tall marker groove, for terminal block width: 12 mm, lettering field size: 11.45 x 10.5 mm, Number of individual labels: 40

UCT-TM 12 - Marker for terminal blocks

0829144

<https://www.phoenixcontact.com/pc/products/0829144>



Marker for terminal blocks, Sheet, white, unlabeled, can be labeled with: TOPMARK NEO, TOPMARK LASER, BLUEMARK ID COLOR, BLUEMARK ID, BLUEMARK CLED, THERMOMARK PRIME, THERMOMARK CARD 2.0, THERMOMARK CARD, mounting type: snapped, for terminal block width: 12 mm, lettering field size: 10.8 x 9.6 mm, Number of individual labels: 30

PLC-RPT- 24UC/21-21AU/MS - Relay Module



2910526

<https://www.phoenixcontact.com/pc/products/2910526>

UCT-TM 12 CUS - Marker for terminal blocks

0829630

<https://www.phoenixcontact.com/pc/products/0829630>



Marker for terminal blocks, can be ordered: by sheet, white, labeled according to customer specifications, mounting type: snap into tall marker groove, for terminal block width: 12 mm, lettering field size: 10.8 x 9.6 mm, Number of individual labels: 30

NS 35/ 7,5 PERF 2000MM - DIN rail perforated

0801733

<https://www.phoenixcontact.com/pc/products/0801733>



DIN rail perforated, Pack of 25 (50 m), acc. to EN 60715, material: Steel, galvanized, passivated with a thick layer, Standard profile, color: silver

PLC-RPT- 24UC/21-21AU/MS - Relay Module



2910526

<https://www.phoenixcontact.com/pc/products/2910526>

NS 35/ 7,5 UNPERF 2000MM - DIN rail, unperforated

0801681

<https://www.phoenixcontact.com/pc/products/0801681>



DIN rail, unperforated, Pack of 25 (50 m), acc. to EN 60715, material: Steel, galvanized, passivated with a thick layer, Standard profile, color: silver

NS 35/ 7,5 WH PERF 2000MM - DIN rail perforated

1204119

<https://www.phoenixcontact.com/pc/products/1204119>



DIN rail perforated, Pack of 25 (50 m), acc. to EN 60715, material: Steel, Galvanized, white passivated, Standard profile, color: silver

PLC-RPT- 24UC/21-21AU/MS - Relay Module



2910526

<https://www.phoenixcontact.com/pc/products/2910526>

NS 35/ 7,5 WH UNPERF 2000MM-VPE 10 - DIN rail, unperforated

1204122

<https://www.phoenixcontact.com/pc/products/1204122>



DIN rail, unperforated, Pack of 10 (20 m), acc. to EN 60715, material: Steel, Galvanized, white passivated, Standard profile, color: silver

NS 35/ 7,5 AL UNPERF 2000MM - DIN rail, unperforated

0801704

<https://www.phoenixcontact.com/pc/products/0801704>



DIN rail, unperforated, Pack of 25 (50 m), acc. to EN 60715, material: Aluminum, uncoated, Standard profile, color: silver

PLC-RPT- 24UC/21-21AU/MS - Relay Module



2910526

<https://www.phoenixcontact.com/pc/products/2910526>

NS 35/ 7,5 ZN PERF 2000MM - DIN rail perforated

1206421

<https://www.phoenixcontact.com/pc/products/1206421>



DIN rail perforated, Pack of 25 (50 m), acc. to EN 60715, material: Steel, galvanized, Standard profile, color: silver

NS 35/ 7,5 ZN UNPERF 2000MM - DIN rail, unperforated

1206434

<https://www.phoenixcontact.com/pc/products/1206434>



DIN rail, unperforated, Pack of 25 (50 m), acc. to EN 60715, material: Steel, galvanized, Standard profile, color: silver

PLC-RPT- 24UC/21-21AU/MS - Relay Module



2910526

<https://www.phoenixcontact.com/pc/products/2910526>

NS 35/ 7,5 CU UNPERF 2000MM-VPE 10 - DIN rail, unperforated

0801762

<https://www.phoenixcontact.com/pc/products/0801762>



DIN rail, unperforated, Pack of 10 (20 m), acc. to EN 60715, material: Copper, uncoated, Standard profile, color: copper-colored

NS 35/ 7,5 CAP - End cap

1206560

<https://www.phoenixcontact.com/pc/products/1206560>

DIN rail end piece, for DIN rail NS 35/7.5



PLC-RPT- 24UC/21-21AU/MS - Relay Module



2910526

<https://www.phoenixcontact.com/pc/products/2910526>

NS 35/15 PERF 2000MM - DIN rail perforated

1201730

<https://www.phoenixcontact.com/pc/products/1201730>



DIN rail perforated, Pack of 25 (50 m), similar to EN 60715, material: Steel, galvanized, passivated with a thick layer, Standard profile, color: silver

NS 35/15 UNPERF 2000MM - DIN rail, unperforated

1201714

<https://www.phoenixcontact.com/pc/products/1201714>



DIN rail, unperforated, Pack of 25 (50 m), similar to EN 60715, material: Steel, galvanized, passivated with a thick layer, Standard profile, color: silver

PLC-RPT- 24UC/21-21AU/MS - Relay Module



2910526

<https://www.phoenixcontact.com/pc/products/2910526>

NS 35/15 WH PERF 2000MM - DIN rail perforated

0806602

<https://www.phoenixcontact.com/pc/products/0806602>



DIN rail perforated, Pack of 25 (50 m), similar to EN 60715, material: Steel, Galvanized, white passivated, Standard profile, color: white

NS 35/15 WH UNPERF 2000MM-VPE 10 - DIN rail, unperforated

1204135

<https://www.phoenixcontact.com/pc/products/1204135>



DIN rail, unperforated, Pack of 10 (20 m), similar to EN 60715, material: Steel, Galvanized, white passivated, Standard profile, color: silver

PLC-RPT- 24UC/21-21AU/MS - Relay Module



2910526

<https://www.phoenixcontact.com/pc/products/2910526>

NS 35/15 AL UNPERF 2000MM - DIN rail, unperforated

1201756

<https://www.phoenixcontact.com/pc/products/1201756>



DIN rail, unperforated, similar to EN 60715, material: Aluminum, uncoated, Standard profile, color: silver

NS 35/15 ZN PERF 2000MM - DIN rail perforated

1206599

<https://www.phoenixcontact.com/pc/products/1206599>



DIN rail perforated, Pack of 25 (50 m), similar to EN 60715, material: Steel, galvanized, Standard profile, color: silver

PLC-RPT- 24UC/21-21AU/MS - Relay Module



2910526

<https://www.phoenixcontact.com/pc/products/2910526>

NS 35/15 ZN UNPERF 2000MM - DIN rail, unperforated

1206586

<https://www.phoenixcontact.com/pc/products/1206586>



DIN rail, unperforated, Pack of 25 (50 m), similar to EN 60715, material: Steel, galvanized, Standard profile, color: silver

NS 35/15 CU UNPERF 2000MM-VPE 10 - DIN rail, unperforated

1201895

<https://www.phoenixcontact.com/pc/products/1201895>



DIN rail, unperforated, Pack of 10 (20 m), similar to EN 60715, material: Copper, uncoated, Standard profile, color: copper-colored

PLC-RPT- 24UC/21-21AU/MS - Relay Module



2910526

<https://www.phoenixcontact.com/pc/products/2910526>

NS 35/15 CAP - End cap

1206573

<https://www.phoenixcontact.com/pc/products/1206573>

DIN rail end piece, for DIN rail NS 35/15



NS 35/15-2,3 UNPERF 2000MM-VPE 10 - DIN rail, unperforated

1201798

<https://www.phoenixcontact.com/pc/products/1201798>

DIN rail, unperforated, Pack of 10 (20 m), acc. to EN 60715, material: Steel, galvanized, passivated with a thick layer, Standard profile 2.3 mm, color: silver



PLC-RPT- 24UC/21-21AU/MS - Relay Module



2910526

<https://www.phoenixcontact.com/pc/products/2910526>

PLC-ATP BK - Separating plate

2966841

<https://www.phoenixcontact.com/pc/products/2966841>



Separating plate, 2 mm thick, required at the start and end of a PLC terminal strip. Furthermore, it is used for: visual separation of groups, safe isolation of different voltages of neighboring PLC relays in acc. with DIN VDE 0106-101, isolation

PLC-ESK GY - Power terminal block

2966508

<https://www.phoenixcontact.com/pc/products/2966508>



Power terminal block, for the input of up to four potentials, for mounting on NS 35/7.5

PLC-RPT- 24UC/21-21AU/MS - Relay Module



2910526

<https://www.phoenixcontact.com/pc/products/2910526>

SZF 1-0,6X3,5 - Screwdriver

1204517

<https://www.phoenixcontact.com/pc/products/1204517>



Actuation tool, for ST terminal blocks, also suitable for use as a bladed screwdriver, size: 0.6 x 3.5 x 100 mm, 2-component grip, with non-slip grip

REL-MR- 24DC/21-21AU/MS - Single relay

2987985

<https://www.phoenixcontact.com/pc/products/2987985>



Plug-in miniature relay, with multi-layer contact with hard gold coating, 2 changeover contacts, test button, mechanical switching position indicator, status LED, freewheeling diode, polarity A1+, A2-, input voltage 24 V DC

Phoenix Contact 2024 © - all rights reserved
<https://www.phoenixcontact.com>

PHOENIX CONTACT GmbH & Co. KG
Flachsmarktstraße 8
D-32825 Blomberg
+49 (0) 5235-3 00
info@phoenixcontact.com