



MPM3810A

6V Input, 1.2A Module Synchronous Step-Down Converter with Integrated Inductor AEC-Q100 Qualified

DESCRIPTION

The MPM3810A is an automotive-grade, step-down module converter with built-in power MOSFETs and an inductor. The module's integrated inductor simplifies the power system design and provides easy and efficient use. The MPM3810A achieves 1.2A of peak output current from a 2.6V to 6V input voltage range with excellent load and line regulation. The output voltage is regulated as low as 0.6V. Only FB resistors and input/output capacitors are required to complete the design.

The constant-on-time control (COT) scheme provides fast transient response and eases loop stabilization. Full protection features include cycle-by-cycle current limiting and thermal shutdown.

The MPM3810A is ideal for a wide range of automotive applications including small ECUs, camera modules, telematics, and infotainment systems.

The MPM3810A is available in a small surface-mounted QFN-12 (2.5mmx3.0mmx0.9mm) package.

FEATURES

- Guaranteed Industrial/Automotive Temp
- Wide 2.6V to 6V Operating Input Range
- Adjustable Output from 0.6V
- Up to 1.2A Peak Output Current
- 100% Duty Cycle in Dropout
- Forced Continuous Conduction Mode (FCCM)
- EN and Power Good (PG) for Power Sequencing
- Cycle-by-Cycle Over-Current Protection (OCP)
- Short-Circuit Protection (SCP) with Hiccup Mode
- Requires only Four External Components: Ceramic Capacitors and FB Divider Resistors
- Available in a QFN-12 (2.5mmx3.0mmx0.9mm) Package
- Total Solution Size: 6mmx3.8mm
- Available in AEC-Q100

APPLICATIONS

- Automotive ECU
- Rear Cameras
- E-Call
- Telematics
- Infotainment Systems

All MPS parts are lead-free, halogen-free, and adhere to the RoHS directive. For MPS green status, please visit the MPS website under Quality Assurance. "MPS", the MPS logo, and "Simple, Easy Solutions" are trademarks of Monolithic Power Systems, Inc. or its subsidiaries.

TYPICAL APPLICATION

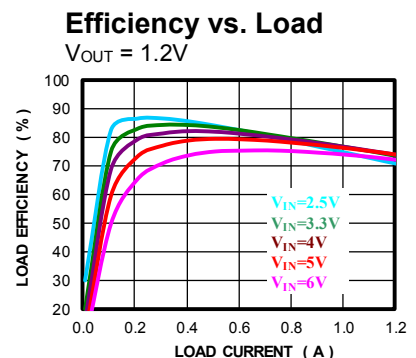
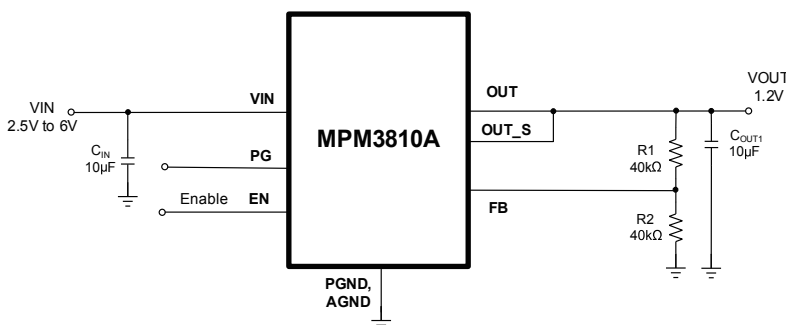

ORDERING INFORMATION

Part Number	Package	Top Marking	MSL Rating
MPM3810AGQB-AEC1*	QFN-12 (2.5mmx3.0mmx0.9mm)	See Below	3
MPM3810AGQBE-AEC1**	QFN-12 (2.5mmx3.0mm)		

* For Tape & Reel, add suffix -Z (e.g. MPM3810AGQB-AEC1-Z).

**Wettable Flank

TOP MARKING (MPM3810AGQB-AEC1)

—
BAL
YWW
LLL

TOP MARKING (MPM3810AGQBE-AEC1)

—
BHN
YWW
LLL

BAL: Product code of MPM3810AGQB-AEC1
Y: Year code
WW: Week code
LLL: Lot number

BHN: Product code of MPM3810AGQBE-AEC1
Y: Year code
WW: Week code
LLL: Lot number

PACKAGE REFERENCE

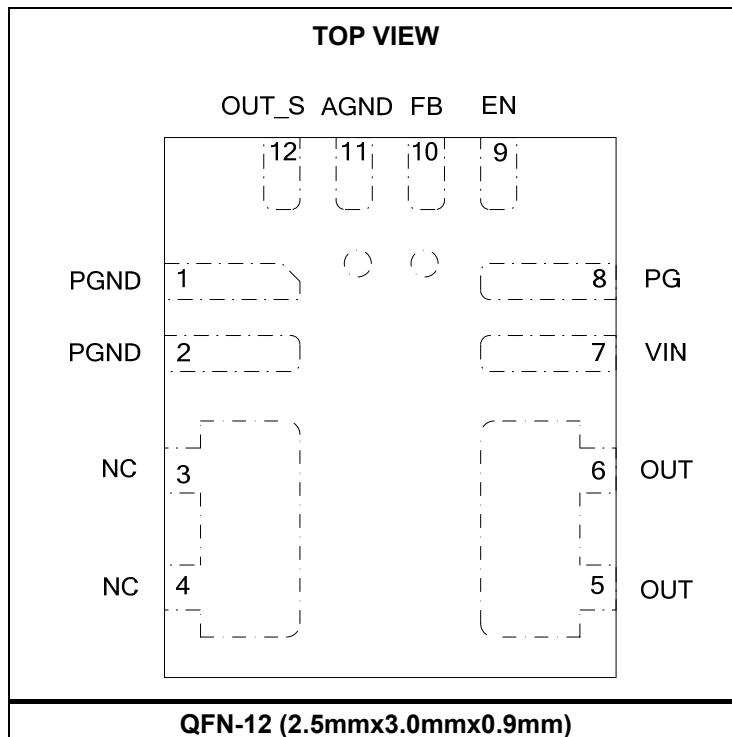

PIN FUNCTIONS

Pin #	Name	Description
1, 2	PGND	Power ground.
3, 4	N/C	Internal SW pad.
5, 6	OUT	Output voltage power rail. Connect the load to OUT. OUT requires an output capacitor.
7	VIN	Supply voltage. The MPM3810A operates from a +2.6V to +6V unregulated input. A decoupling capacitor is needed to prevent large voltage spikes from appearing at the input. Place the decoupling capacitor as close to VIN as possible.
8	PG	Power good indicator. The output of PG is an open drain with an internal pull-up resistor to VIN. PG is pulled up to VIN when the FB voltage is within 10% of the regulation level. If the FB voltage is out of that regulation range, PG is low.
9	EN	On/off control.
10	FB	Feedback. An external resistor divider from the output to GND tapped to FB sets the output voltage.
11	AGND	Analog ground for internal control circuit.
12	OUT_S	Output voltage sense.

ABSOLUTE MAXIMUM RATINGS ⁽¹⁾

Supply voltage (V_{IN})	6.5V
V_{SW}	-0.3V (-5V for <10ns) to 6.5V (7V for <10ns)
All other pins	-0.3V to 6.5V
Junction temperature	150°C
Lead temperature	260°C
Continuous power dissipation ($T_A = +25^\circ\text{C}$) ⁽²⁾	1.9W
Storage temperature	-65°C to +150°C

ESD Rating

Human-body model (HBM)	±2000V
Charged-device model (CDM)	±750V

Recommended Operating Conditions

Supply voltage (V_{IN})	2.6V to 6V
Output voltage (V_{OUT})	12% $\times V_{IN}$ to V_{IN}
Operating junction temp. (T_J)	-40°C to +125°C

Thermal Resistance ⁽³⁾	θ_{JA}	θ_{JC}
QFN-12 (2.5mmx3.0mm)	65	13 ... °C/W

NOTES:

- Exceeding these ratings may damage the device.
- The maximum allowable power dissipation is a function of the maximum junction temperature T_J (MAX), the junction-to-ambient thermal resistance θ_{JA} , and the ambient temperature T_A . The maximum allowable continuous power dissipation at any ambient temperature is calculated by P_D (MAX) = $(T_J$ (MAX) - T_A) / θ_{JA} . Exceeding the maximum allowable power dissipation produces an excessive die temperature, causing the device to go into thermal shutdown. Internal thermal shutdown circuitry protects the device from permanent damage.
- Measured on JESD51-7, 4-layer PCB.

ELECTRICAL CHARACTERISTICS

$V_{IN} = 5V$, $T_J = -40^{\circ}C$ to $+125^{\circ}C$, unless otherwise noted. Typical values are at $T_J = +25^{\circ}C$.

Parameter	Symbol	Condition	Min	Typ	Max	Units
Feedback voltage	V_{FB}	$2.6V \leq V_{IN} \leq 6V$, $T_J = -40^{\circ}C$ to $+125^{\circ}C$	573		627	mV
Feedback current	I_{FB}	$V_{FB} = 0.63V$		10	1000	nA
P-FET switch-on resistance	R_{DSON_P}			110	170	m Ω
N-FET switch-on resistance	R_{DSON_N}			60	130	m Ω
Inductor L value	L	Inductance value at 1MHz		0.47		μH
Inductor DC resistance	R_{DCR}			125		m Ω
Dropout resistance	R_{DR}	100% on duty		235		m Ω
Switch leakage		$V_{EN} = 0V$, $V_{IN} = 6V$, $V_{SW} = 0V$ and $6V$, $T_J = +25^{\circ}C$		0	1	μA
PFET current limit		$T_J = +25^{\circ}C$	1.6	2.1	2.6	A
		$T_J = -40^{\circ}C$ to $+125^{\circ}C$	1.5		2.7	
On time	T_{ON}	$V_{IN} = 5V$, $V_{OUT} = 1.2V$		70		ns
		$V_{IN} = 3.6V$, $V_{OUT} = 1.2V$		100		
Switching frequency	F_s	$V_{IN} = 3.6V$, $V_{OUT} = 1.2V$	2400	3500	4200	kHz
Minimum off time	$T_{MIN-OFF}$			60		ns
Soft-start time	T_{SS-ON}			1.5		ms
Power good upper trip threshold	PG_H	FB voltage in respect to the regulation		+10		%
Power good lower trip threshold	PG_L			-10		%
Power good delay	PG_D			50		μs
Power good sink current capability	V_{PG-L}	Sink 1mA			0.4	V
Power good logic high voltage	V_{PG-H}	$V_{IN} = 5V$, $V_{FB} = 0.6V$	4.0			V
Power good internal pull-up resistor	R_{PG}			550		k Ω
Under-voltage lockout threshold rising			2.2	2.4	2.6	V
Under-voltage lockout threshold hysteresis				300		mV
EN input logic low voltage					0.4	V
EN input logic high voltage			1.2			V
EN input current		$V_{EN} = 2V$		1.5		μA
		$V_{EN} = 0V$		0.1	1	μA

**ELECTRICAL CHARACTERISTICS (continued)** $V_{IN} = 5V$, $T_J = -40^{\circ}C$ to $+125^{\circ}C$, unless otherwise noted. Typical values are at $T_J = +25^{\circ}C$.

Parameter	Symbol	Condition	Min	Typ	Max	Units
Supply current (shutdown)		$V_{EN} = 0V$, $T_J = +25^{\circ}C$			1	μA
		$V_{EN} = 0V$, $T_J = -40^{\circ}C$ to $+125^{\circ}C$			10	
Supply current (quiescent)		$V_{EN} = 2V$, $V_{FB} = 0.63V$, $V_{IN} = 5V$, $T_J = +25^{\circ}C$		485	560	μA
		$V_{EN} = 2V$, $V_{FB} = 0.63V$, $V_{IN} = 5V$, $T_J = -40^{\circ}C$ to $+125^{\circ}C$			650	
Thermal shutdown ⁽⁴⁾				150		$^{\circ}C$
Thermal hysteresis ⁽⁴⁾				30		$^{\circ}C$

NOTE:

4) Not tested in production, guaranteed by design.

TYPICAL PERFORMANCE CHARACTERISTICS

$V_{IN} = 5V$, $V_{OUT} = 1.2V$, $C_{IN} = 10\mu F$, $C_{OUT} = 20\mu F$, $T_A = +25^\circ C$, unless otherwise noted.

Shutdown Current vs. VIN

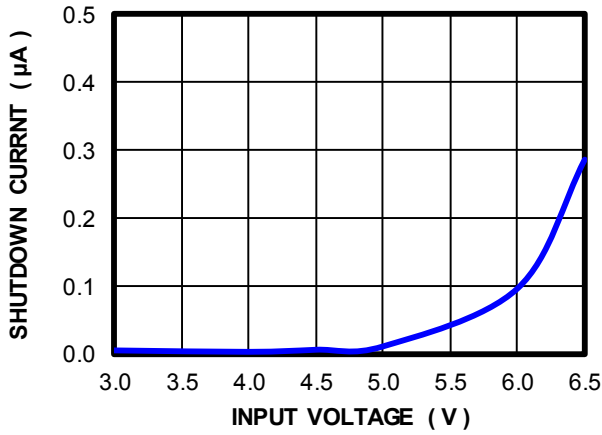

Maximum I_{OUT} vs. Ambient Temperature

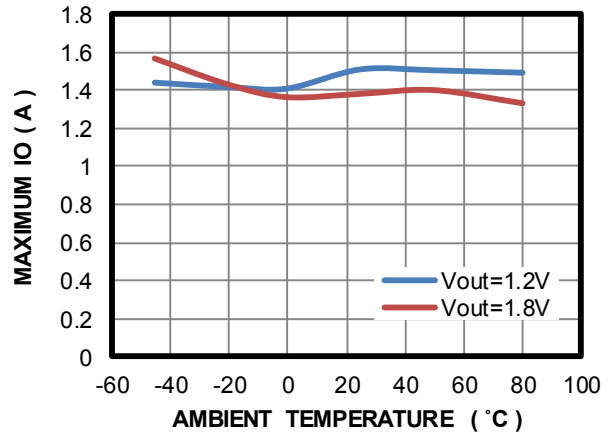

Output Current Derating vs. Output Voltage

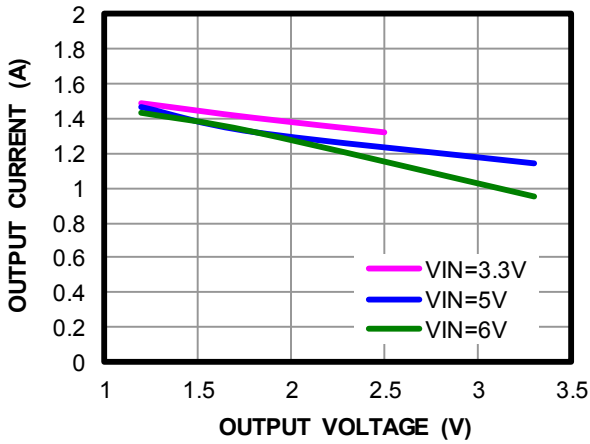

Efficiency vs. Load

$V_{OUT} = 1.2V$

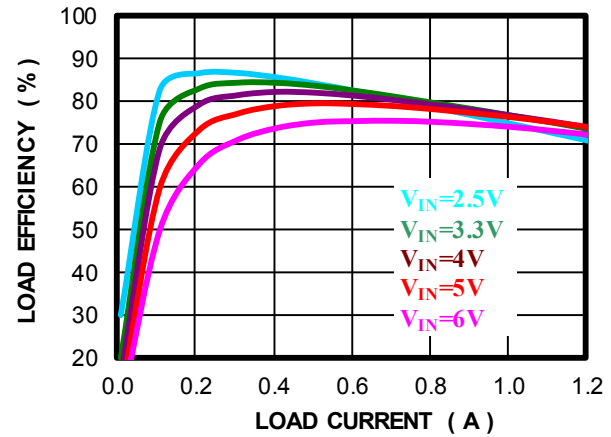

Efficiency vs. Line

$V_{OUT} = 1.2V$

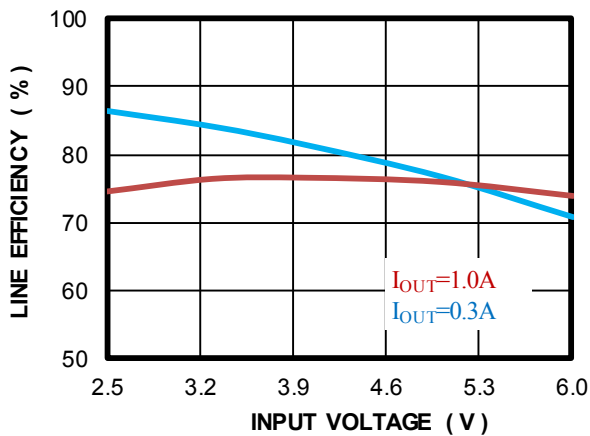

Load Regulation

$V_{OUT} = 1.2V$

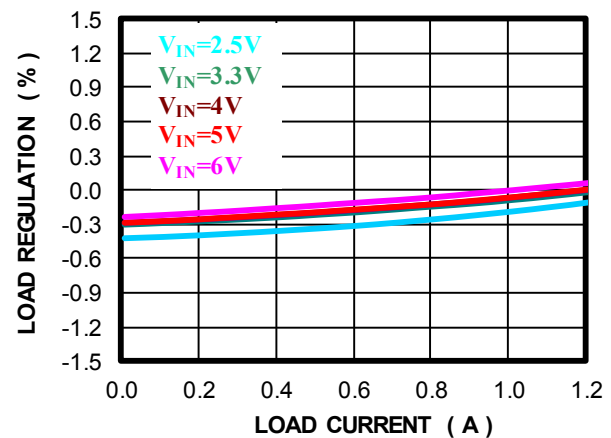

TYPICAL PERFORMANCE CHARACTERISTICS (continued)

$V_{IN} = 5V$, $C_{IN} = 10\mu F$, $C_{OUT} = 20\mu F$, $T_A = +25^\circ C$, unless otherwise noted.

Line Regulation

$V_{OUT} = 1.2V$

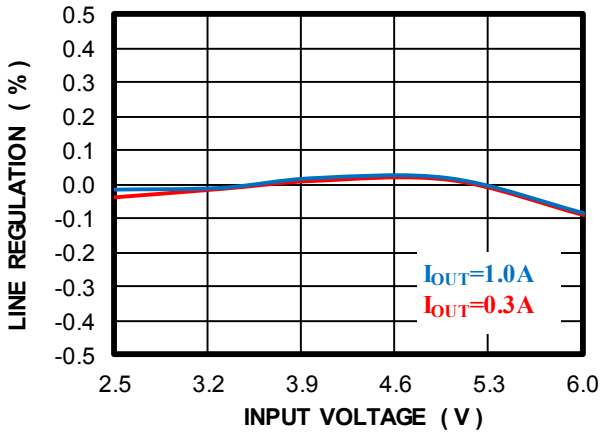

Efficiency vs. Load

$V_{OUT} = 1.8V$

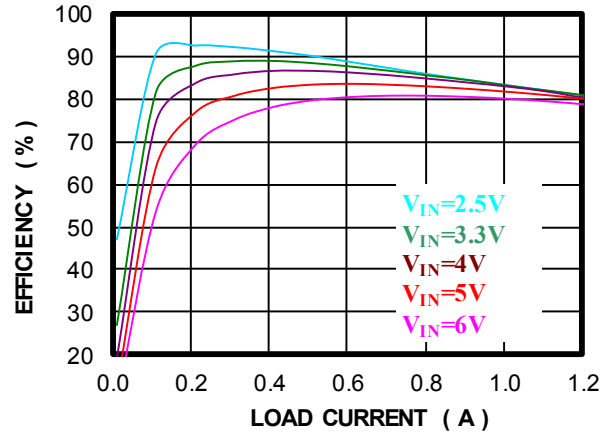

Efficiency vs. Line

$V_{OUT} = 1.8V$

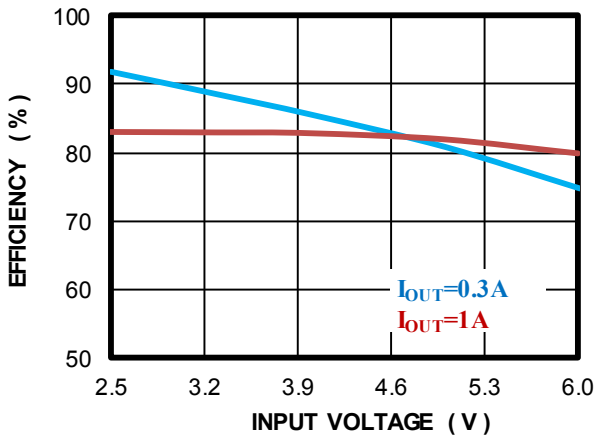

Load Regulation

$V_{OUT} = 1.8V$

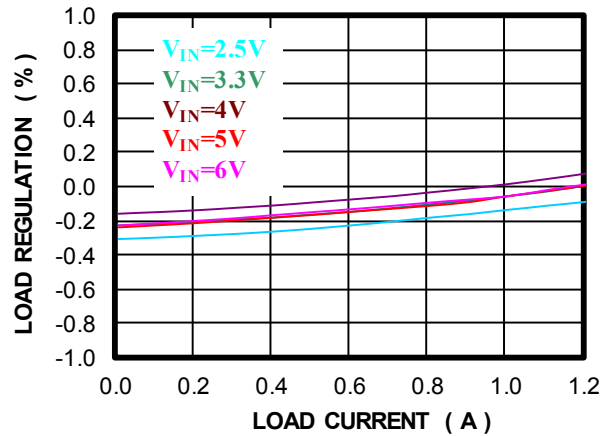

Line Regulation

$V_{OUT} = 1.8V$

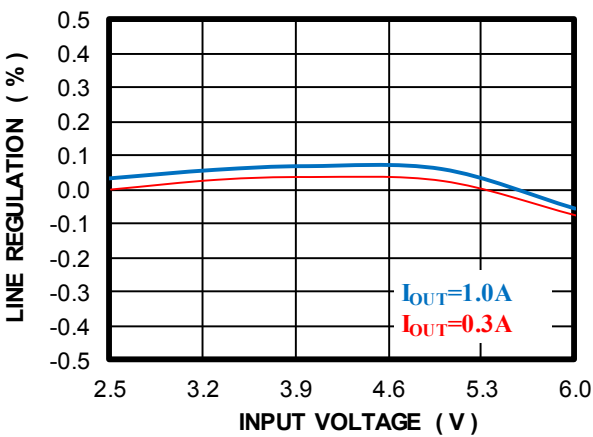

TYPICAL PERFORMANCE CHARACTERISTICS *(continued)*

$V_{IN} = 5V$, $V_{OUT} = 1.2V$, $C_{IN} = 10\mu F$, $C_{OUT} = 20\mu F$, $T_A = +25^\circ C$, unless otherwise noted.

P-FET Current Limit vs. T_A

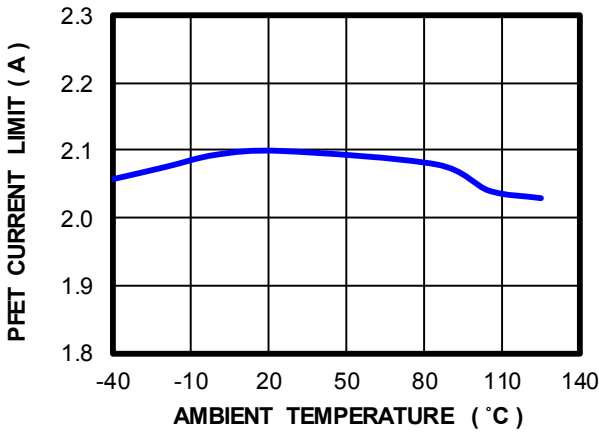

Switch Frequency vs. T_A

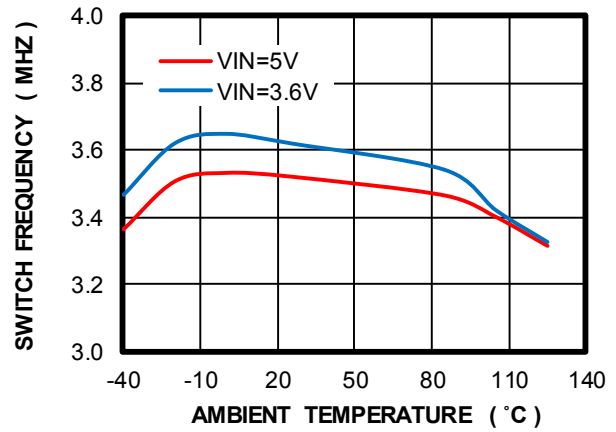

Enable On/Off vs. T_A

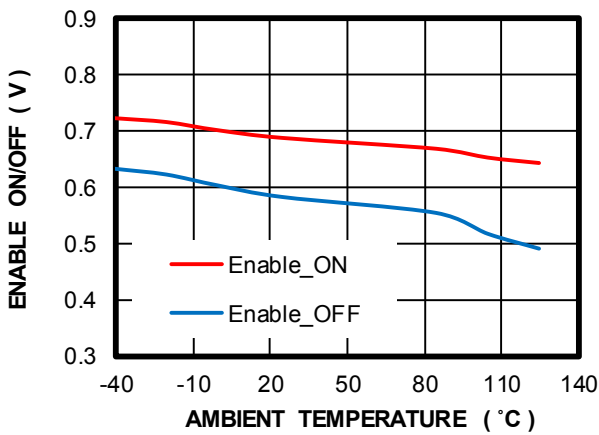

Feedback Voltage vs. T_A

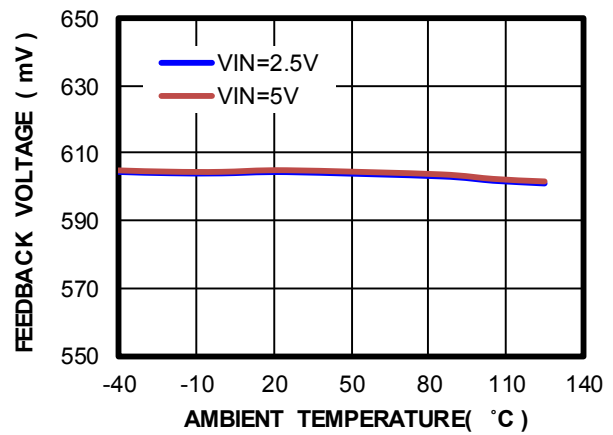

Supply Current vs. T_A

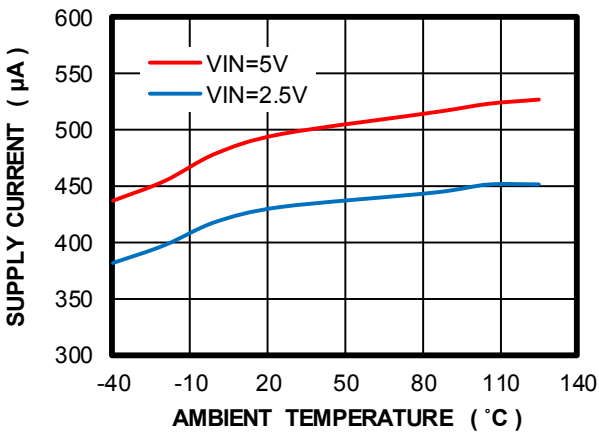

TYPICAL PERFORMANCE CHARACTERISTICS (continued)

$V_{IN} = 5V$, $C_{IN} = 10\mu F$, $C_{OUT} = 20\mu F$, $T_A = +25^\circ C$, unless otherwise noted.

Steady State

$V_{IN} = 5V$, $V_{OUT} = 1.2V$, $I_{OUT} = 0.1A$

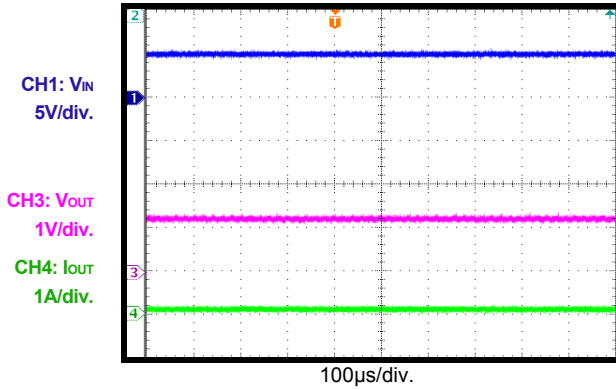

Steady State

$V_{IN} = 5V$, $V_{OUT} = 1.2V$, $I_{OUT} = 0.6A$

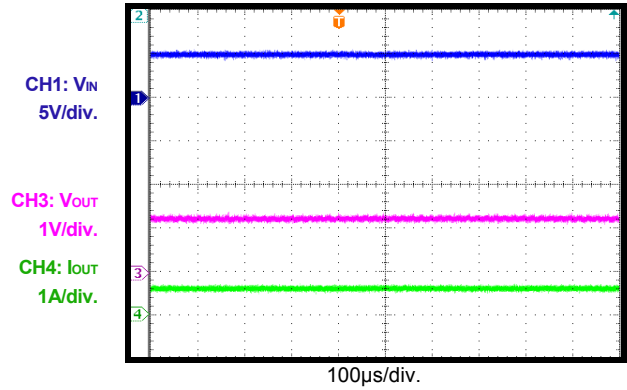

Steady State

$V_{IN} = 5V$, $V_{OUT} = 1.2V$, $I_{OUT} = 1.2A$

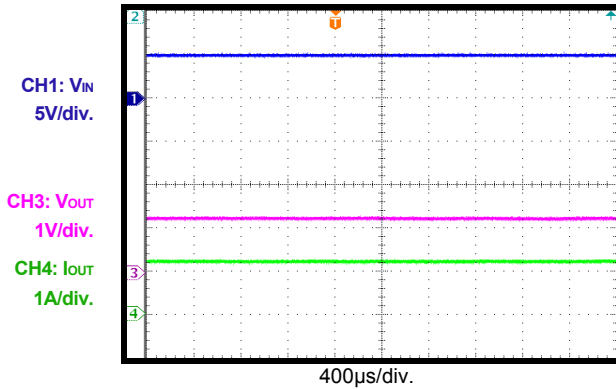

Steady State

$V_{IN} = 5V$, $V_{OUT} = 1.8V$, $I_{OUT} = 0.1A$

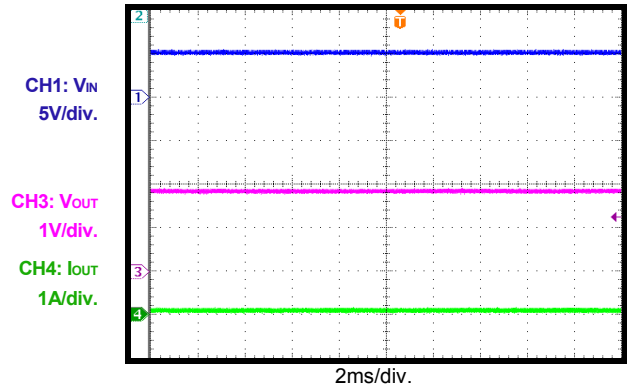

Steady State

$V_{IN} = 5V$, $V_{OUT} = 1.8V$, $I_{OUT} = 0.6A$

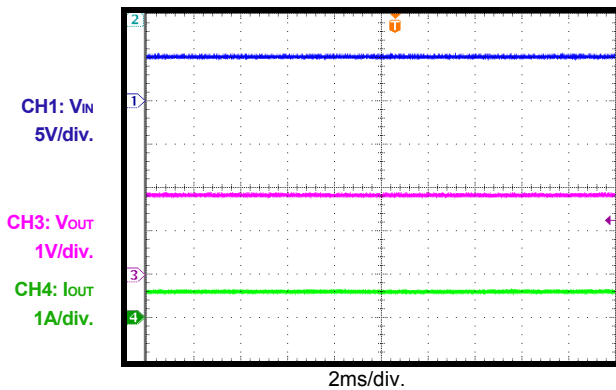

Steady State

$V_{IN} = 5V$, $V_{OUT} = 1.8V$, $I_{OUT} = 1.2A$

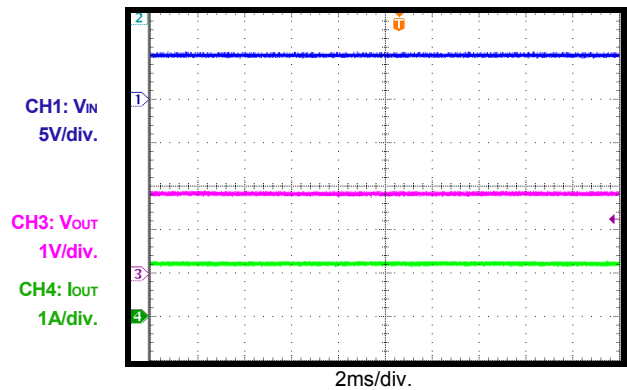

TYPICAL PERFORMANCE CHARACTERISTICS (continued)

$V_{IN} = 5V$, $C_{IN} = 10\mu F$, $C_{OUT} = 20\mu F$, $T_A = +25^\circ C$, unless otherwise noted.

Power Up

$V_{IN} = 2.5V$, $V_{OUT} = 1.2V$, $I_{OUT} = 0.6A$

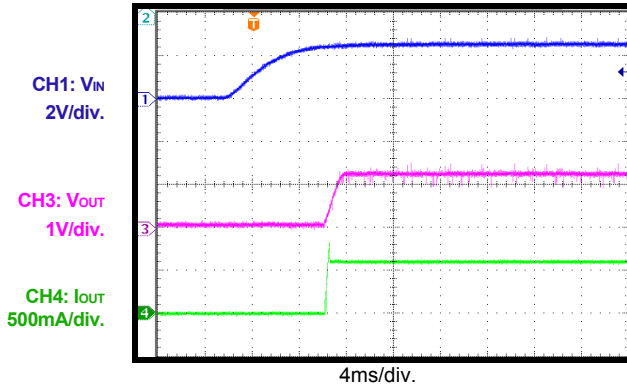

Power Down

$V_{IN} = 2.5V$, $V_{OUT} = 1.2V$, $I_{OUT} = 0.6A$

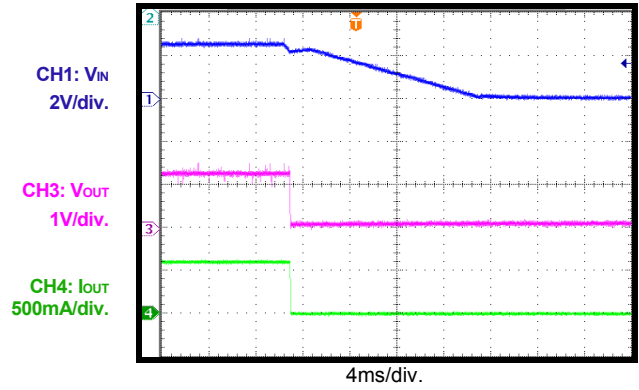

Power Up

$V_{IN} = 3.3V$, $V_{OUT} = 1.8V$, $I_{OUT} = 0.6A$

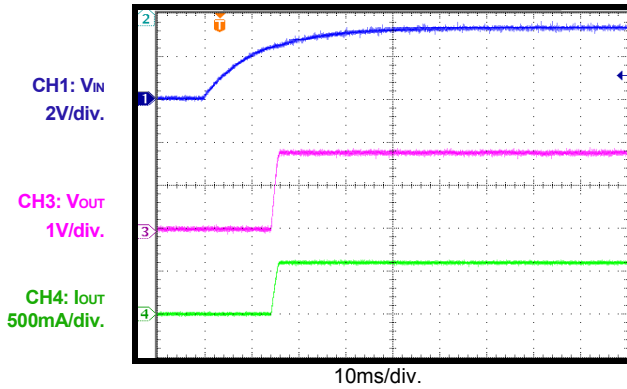

Power Down

$V_{IN} = 3.3V$, $V_{OUT} = 1.8V$, $I_{OUT} = 0.6A$

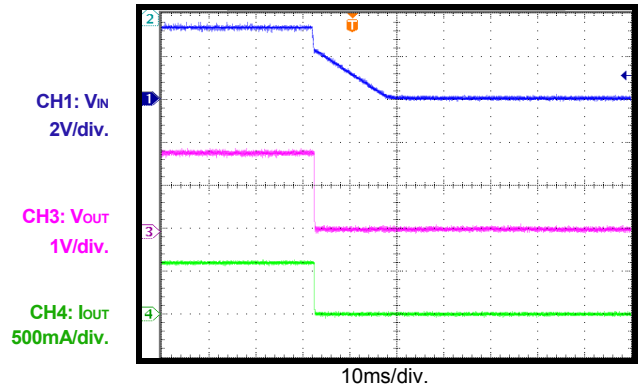

Enable On

$V_{IN} = 2.5V$, $V_{OUT} = 1.2V$, $I_{OUT} = 0.6A$

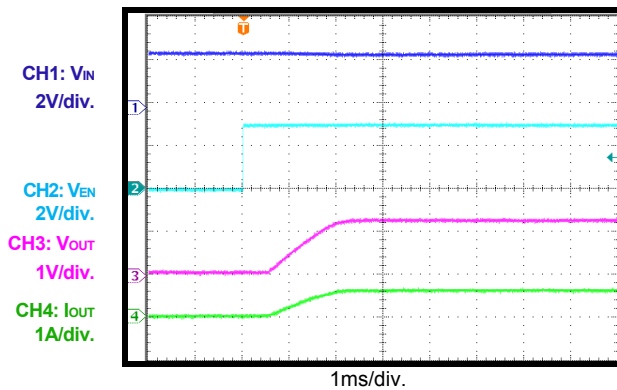

Enable Off

$V_{IN} = 2.5V$, $V_{OUT} = 1.2V$, $I_{OUT} = 0.6A$

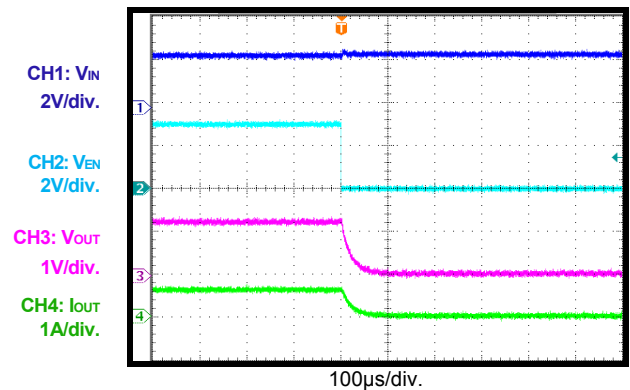

TYPICAL PERFORMANCE CHARACTERISTICS (continued)

$V_{IN} = 5V$, $C_{IN} = 10\mu F$, $C_{OUT} = 20\mu F$, $T_A = +25^\circ C$, unless otherwise noted.

Enable On

$V_{IN} = 3.3V$, $V_{OUT} = 1.8V$, $I_{OUT} = 0.6A$

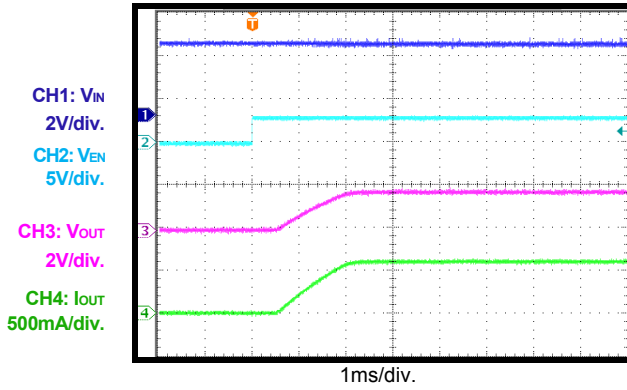

Enable Off

$V_{IN} = 3.3V$, $V_{OUT} = 1.8V$, $I_{OUT} = 0.6A$

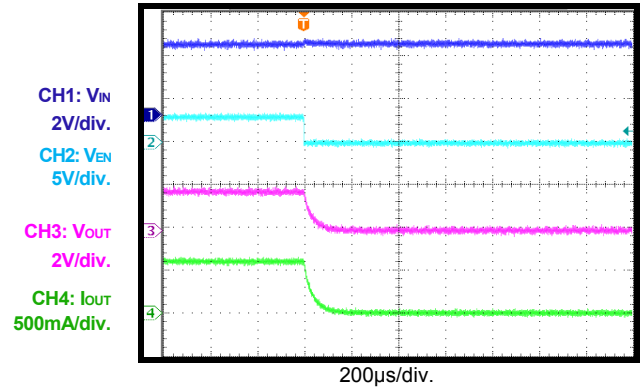

Steady State

$V_{IN} = 5V$, $V_{OUT} = 1.8V$, $I_{OUT} = 0.6A$

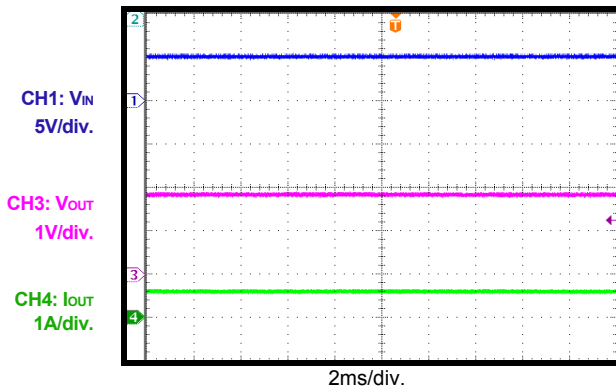

Steady State

$V_{IN} = 5V$, $V_{OUT} = 1.2V$, $I_{OUT} = 0.6A$

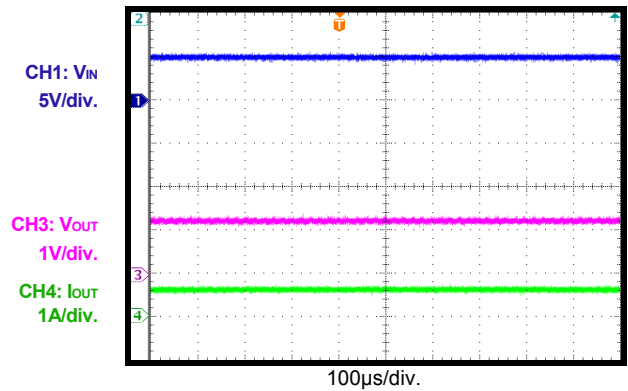

Short Circuit

$V_{IN} = 5V$, $V_{OUT} = 1.2V$

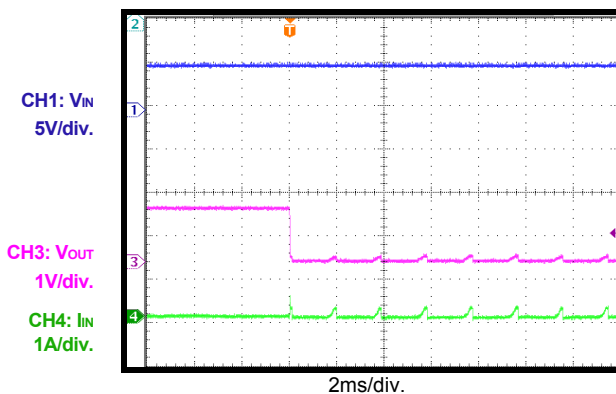

Short-Circuit Recovery

$V_{IN} = 5V$, $V_{OUT} = 1.2V$

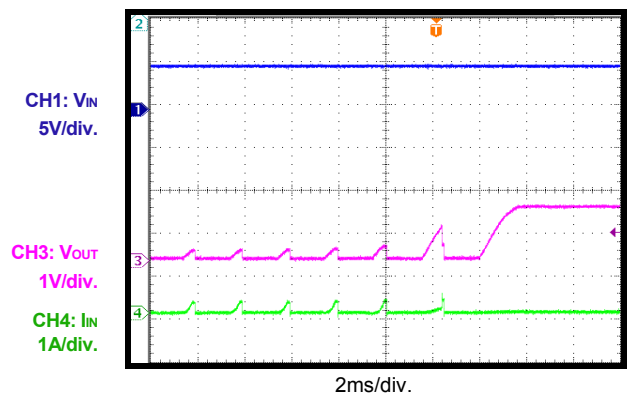

TYPICAL PERFORMANCE CHARACTERISTICS (continued)

$V_{IN} = 5V$, $C_{IN} = 10\mu F$, $C_{OUT} = 20\mu F$, $T_A = +25^\circ C$, unless otherwise noted.

Short-Circuit Entry

$V_{IN} = 5V$, $V_{OUT} = 1.8V$

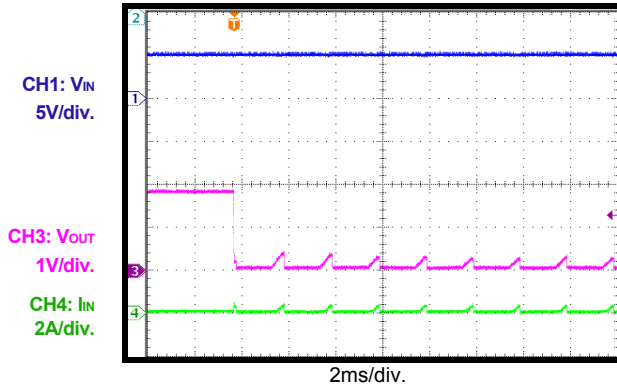

Short Circuit

$V_{IN} = 5V$, $V_{OUT} = 1.8V$

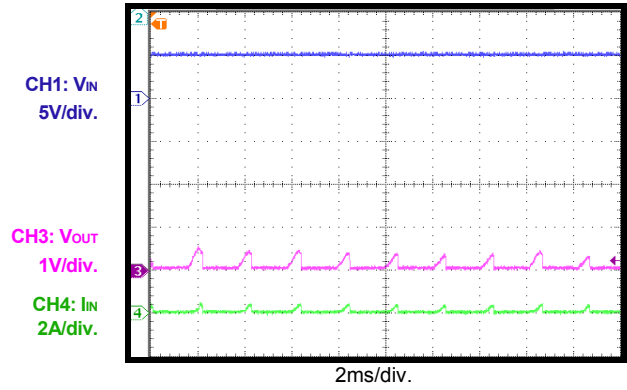

Short-Circuit Recovery

$V_{IN} = 5V$, $V_{OUT} = 1.2V$

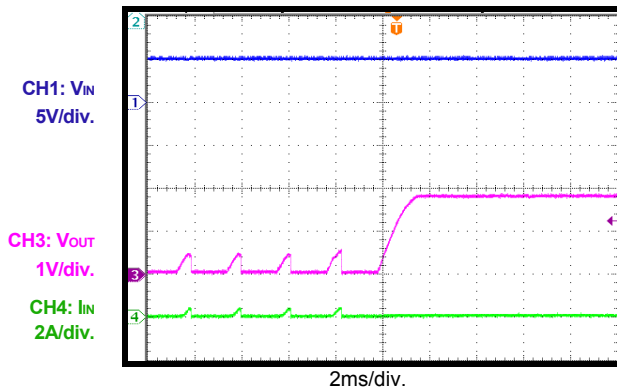

Transient Response

$V_{IN} = 2.5V$, $V_{OUT} = 1.2V$, $I_{OUT} = 0 - 0.6A$, $0.25A/\mu s$

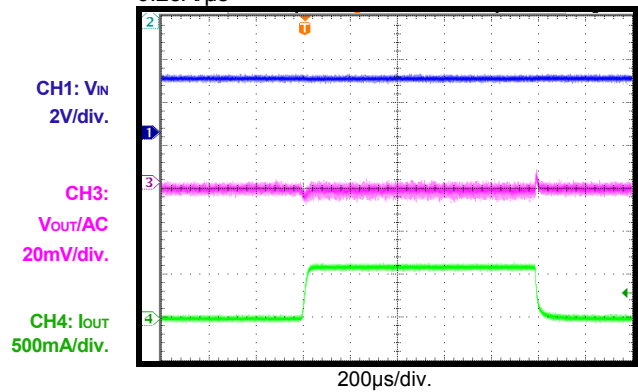

Transient Response

$V_{IN} = 3.3V$, $V_{OUT} = 1.2V$, $I_{OUT} = 0 - 0.6A$, $0.25A/\mu s$

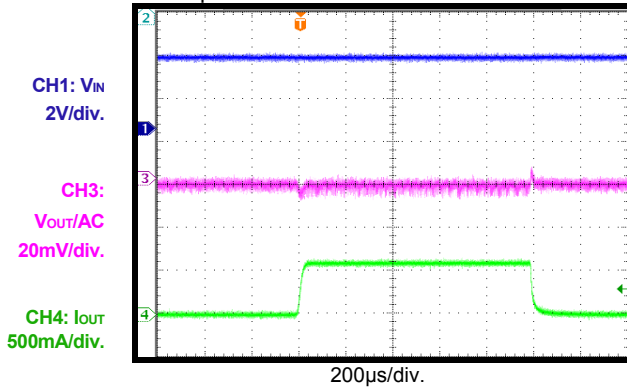

Transient Response

$V_{IN} = 6V$, $V_{OUT} = 1.2V$, $I_{OUT} = 0 - 0.6A$, $0.25A/\mu s$

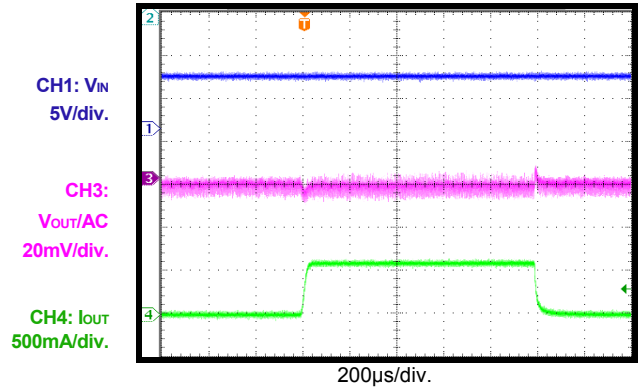

TYPICAL PERFORMANCE CHARACTERISTICS *(continued)*

$V_{IN} = 5V$, $C_{IN} = 10\mu F$, $C_{OUT} = 20\mu F$, $T_A = +25^\circ C$, unless otherwise noted.

Transient Response

$V_{IN} = 2.5V$, $V_{OUT} = 1.8V$, $I_{OUT} = 0 - 0.6A$, $0.25A/\mu s$

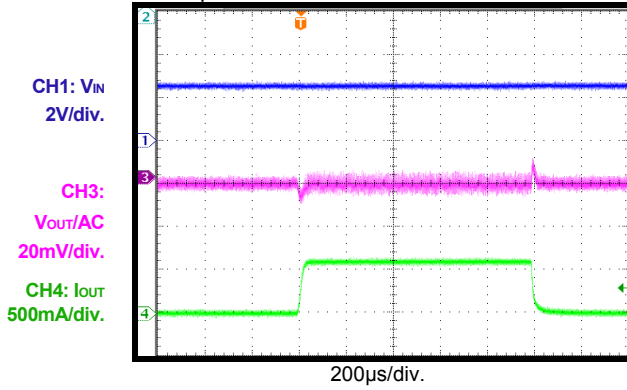

Transient Response

$V_{IN} = 3.3V$, $V_{OUT} = 1.8V$, $I_{OUT} = 0 - 0.6A$, $0.25A/\mu s$

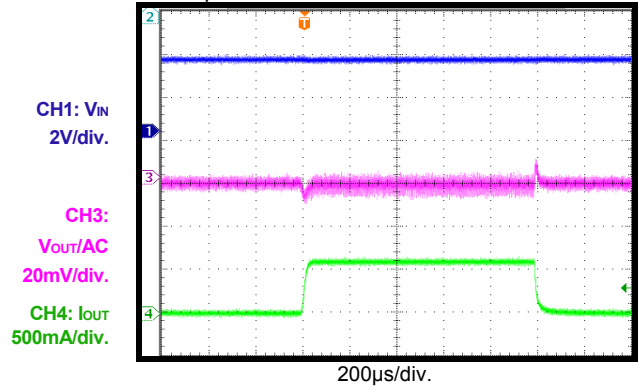

Transient Response

$V_{IN} = 6V$, $V_{OUT} = 1.8V$, $I_{OUT} = 0 - 0.6A$, $0.25A/\mu s$

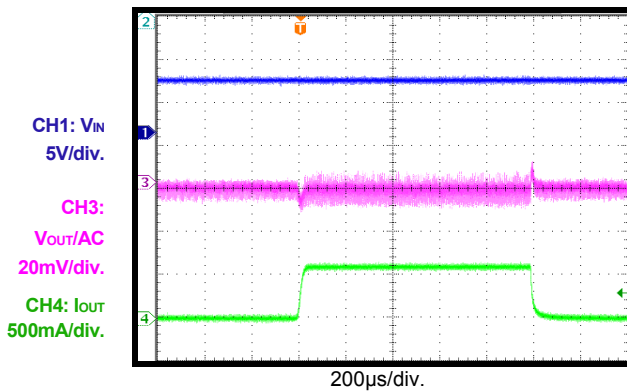

BLOCK DIAGRAM

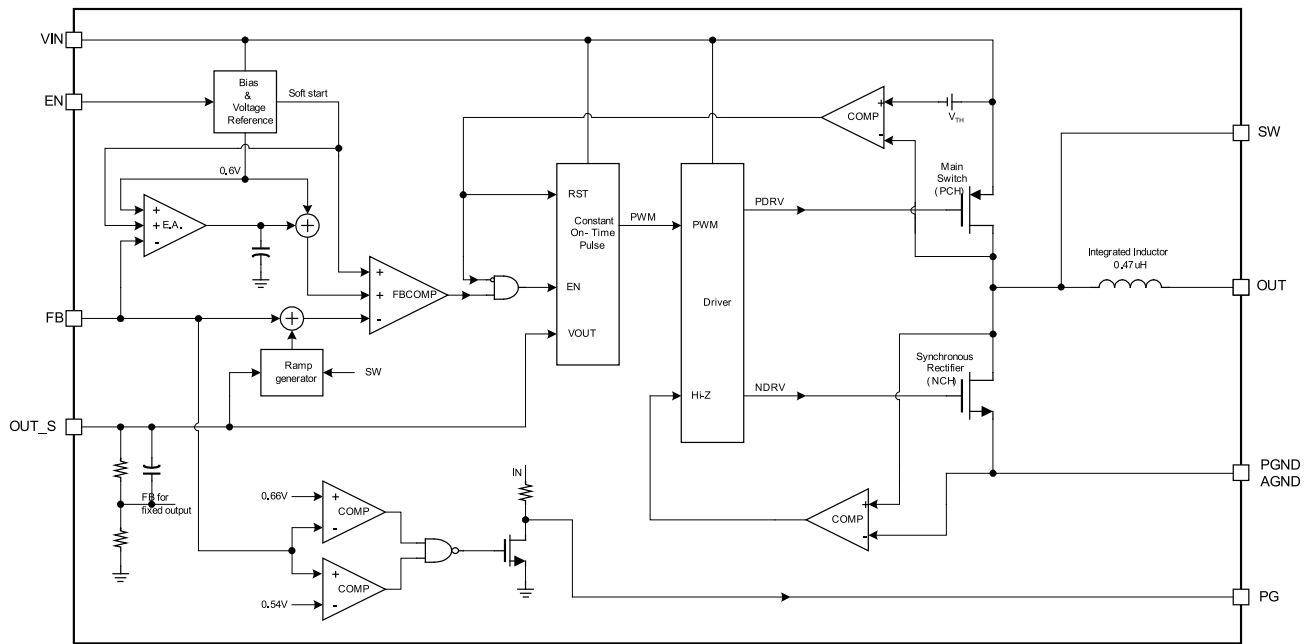

Figure 1: Functional Block Diagram

OPERATION

The MPM3810A has an integrated inductor that simplifies the schematic and layout designs. Only FB resistors and input/output capacitors are required to complete the design. The MPM3810A uses constant-on-time control (COT) with input voltage feed-forward to stabilize the switching frequency over a full input range. At light load, the MPM3810A employs a proprietary control of the low-side switch and inductor current to improve efficiency.

Constant-On-Time Control (COT)

Compared to a fixed-frequency pulse-width modulation (PWM) control, COT control offers the advantage of a simpler control loop and faster transient response. By using input voltage feed-forward, the MPM3810A maintains a nearly constant switching frequency across the input and output voltage ranges. The on time of the switching pulse can be estimated with Equation (1):

$$T_{ON} = \frac{V_{OUT}}{V_{IN}} \cdot 0.28\mu s \quad (1)$$

To prevent inductor current runaway during the load transition, the MPM3810A fixes the minimum off time at 60ns. This minimum off-time limit does not affect operation in a steady state.

The MPM3810A works in forced continuous conduction mode (CCM).

Enable (EN)

If the input voltage is greater than the under-voltage lockout threshold (UVLO) (typically 2.3V), the MPM3810A is enabled by pulling EN above 1.2V. Leave EN floating or pull EN down to ground to disable the MPM3810A. There is an internal 1MΩ resistor from EN to ground.

Soft Start (SS)

The MPM3810A has a built-in soft start that ramps up the output voltage at a controlled slew rate to prevent overshoots during start-up. The soft-start time is about 1.5ms, typically.

Power Good Indicator (PG)

The MPM3810A has an open-drain pin with a 550kΩ pull-up resistor for power good indication (PG). When FB is within ±10% of the regulation voltage (i.e.: 0.6V), PG is pulled up to VIN by the internal resistor. If FB voltage is out of the ±10% window, PG is pulled down to ground by an internal MOSFET. The MOSFET has a maximum R_{DS(ON)} of less than 400Ω.

Current Limit

The MPM3810A has a typical 2.1A current limit for the high-side switch. When the high-side switch reaches the current limit, the MPM3810A is limited to the hiccup threshold until the current decreases. This prevents the inductor current from continuing to build and damaging components.

Short Circuit and Recovery

The MPM3810A enters short-circuit protection (SCP) mode when the current limit is reached. The MPM3810A then attempts to recover from the short circuit with hiccup mode. In SCP, the MPM3810A disables the output power stage, discharges the soft-start capacitor, and attempts to soft start again automatically. If the short circuit still remains after the soft start ends, the MPM3810A repeats the cycle until the short circuit is removed and the output rises back to the regulation level.

APPLICATION INFORMATION

Setting the Output Voltage

The external resistor divider is used to set the output voltage (see the Typical Application on page 18). The feedback resistor (R1) cannot be too large or too small considering the trade-off for stability and dynamics. Choose a value for R1 between 40kΩ to 80kΩ. R2 is can then be calculated with Equation (2):

$$R2 = \frac{R1}{\frac{V_{out}}{0.6} - 1} \quad (2)$$

The feedback circuit is shown in Figure 2.

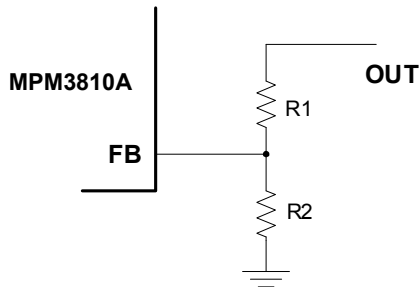

Figure 2: Feedback Network

Table 1 lists the recommended resistor values for common output voltages.

Table 1: Resistor Values for Common Output Voltages

V _{OUT} (V)	R1 (kΩ)	R2 (kΩ)
1.0	40 (1%)	60 (1%)
1.2	40 (1%)	40 (1%)
1.8	60 (1%)	30 (1%)
2.5	80 (1%)	25 (1%)
3.3	80 (1%)	17.7 (1%)

Selecting the Input Capacitor

The input current to the step-down converter is discontinuous and therefore requires a capacitor to supply AC current while maintaining the DC input voltage. For optimal performance, use low ESR capacitors. Ceramic capacitors with X5R or X7R dielectrics are highly recommended for their low ESR and small temperature coefficients. For most applications, a 10μF capacitor is sufficient.

For a higher output voltage, a 22μF may be needed to enhance system stability.

Since the input capacitor absorbs the input switching current, it requires an adequate ripple current rating. The RMS current in the input capacitor can be estimated with Equation (3):

$$I_{C1} = I_{LOAD} \times \sqrt{\frac{V_{OUT}}{V_{IN}} \times \left(1 - \frac{V_{OUT}}{V_{IN}}\right)} \quad (3)$$

The worst-case condition occurs at V_{IN} = 2V_{OUT}, shown in Equation (4):

$$I_{C1} = \frac{I_{LOAD}}{2} \quad (4)$$

For simplification, choose an input capacitor with an RMS current rating greater than half of the maximum load current.

The input capacitor can be electrolytic, tantalum, or ceramic. When using electrolytic or tantalum capacitors, add a small, high-quality ceramic capacitor (i.e.: 0.1μF) as close to the IC as possible. When using ceramic capacitors, ensure they have enough capacitance to provide a sufficient charge to prevent an excessive voltage ripple at the input. The input voltage ripple caused by the capacitance is estimated with Equation (5):

$$\Delta V_{IN} = \frac{I_{LOAD}}{f_s \times C1} \times \frac{V_{OUT}}{V_{IN}} \times \left(1 - \frac{V_{OUT}}{V_{IN}}\right) \quad (5)$$

Selecting the Output Capacitor

The output capacitor (C_{OUT}) is required to maintain the DC output voltage. For the best performance, use low ESR ceramic capacitors to keep the output voltage ripple low. The output voltage ripple is estimated with Equation (6):

$$\Delta V_{OUT} = \frac{V_{OUT}}{f_s \times L_1} \times \left(1 - \frac{V_{OUT}}{V_{IN}}\right) \times \left(R_{ESR} + \frac{1}{8 \times f_s \times C2}\right) \quad (6)$$

Where L₁ is the inductor value, and R_{ESR} is the equivalent series resistance (ESR) value of the output capacitor (L₁ is 0.47μH).

When using ceramic capacitors, the impedance at the switching frequency is dominated by the capacitance. The output voltage ripple is caused mainly by the capacitance.

For simplification, the output voltage ripple is estimated with Equation (7):

$$\Delta V_{OUT} = \frac{V_{OUT}}{8 \times f_s^2 \times L_1 \times C_2} \times \left(1 - \frac{V_{OUT}}{V_{IN}} \right) \quad (7)$$

When using tantalum or electrolytic capacitors, the ESR dominates the impedance at the switching frequency. For simplification, the output ripple can be approximated with Equation (8):

$$\Delta V_{OUT} = \frac{V_{OUT}}{f_s \times L_1} \times \left(1 - \frac{V_{OUT}}{V_{IN}} \right) \times R_{ESR} \quad (8)$$

The characteristics of the output capacitor affect the stability of the regulation system.

PCB Layout Guidelines

Efficient PCB layout is critical for stable operation. The module's integrated inductor simplifies the schematic and layout design. Only FB resistors and input/output capacitors are needed to complete the design. For best results, refer to Figure 3 and Figure 4 and follow the guidelines below.

1. Place the high-current paths (PGND, VIN, and OUT) very close to the device with short, direct, and wide traces.
2. Place the input capacitor as close to VIN and PGND as possible.
3. Place the external feedback resistors next to FB.
4. Keep the switching node away from the feedback network.

For additional device applications, please refer to related evaluation board datasheets.

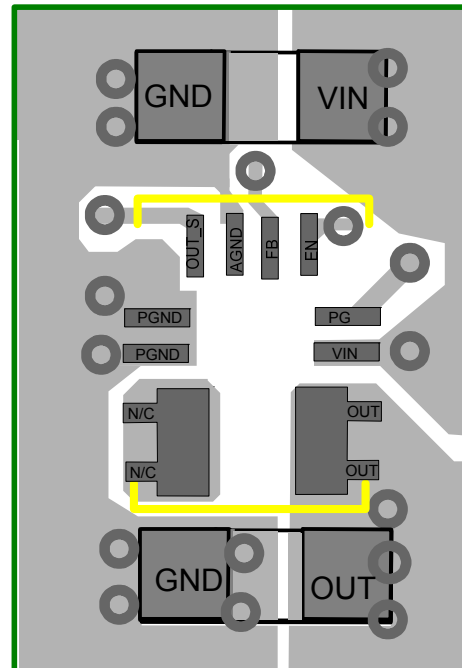

Figure 3: Top View of Layout Guide

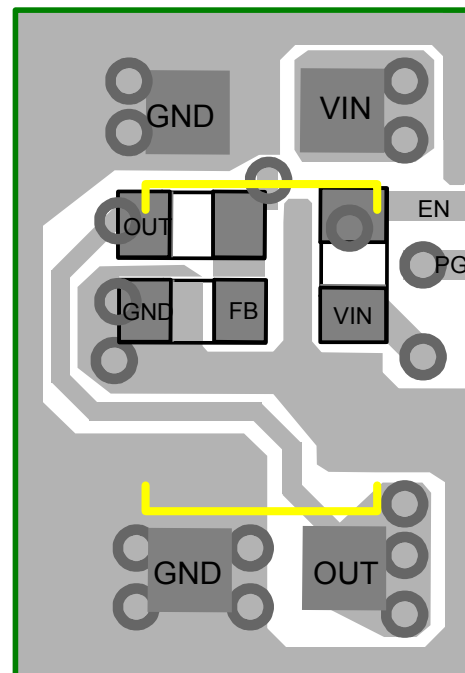

Figure 4: Bottom View of Layout Guide

TYPICAL APPLICATION CIRCUIT

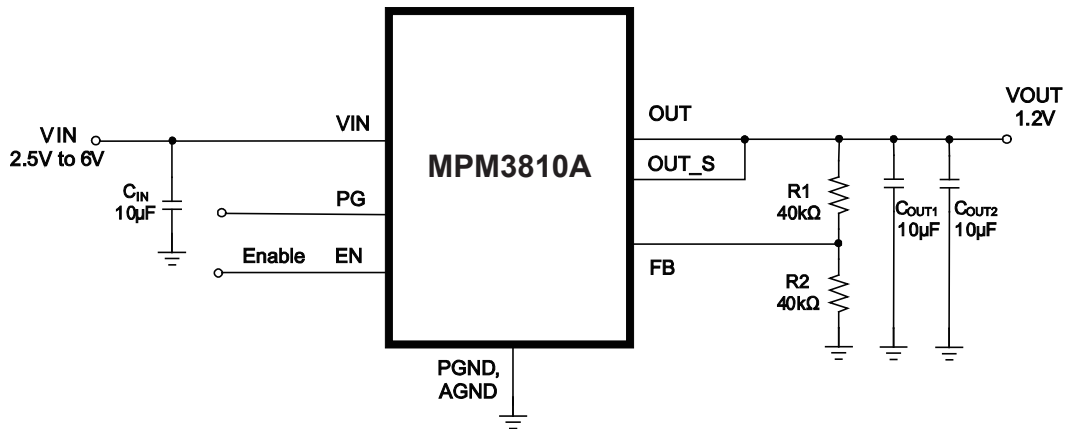
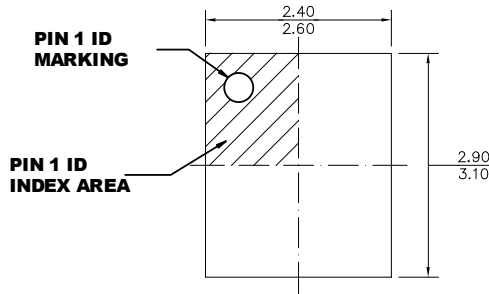

Figure 5: Typical Application Circuit

PACKAGE INFORMATION

QFN-12 (2.5mmx3.0mmx0.9mm) MPM3810AGQB



TOP VIEW

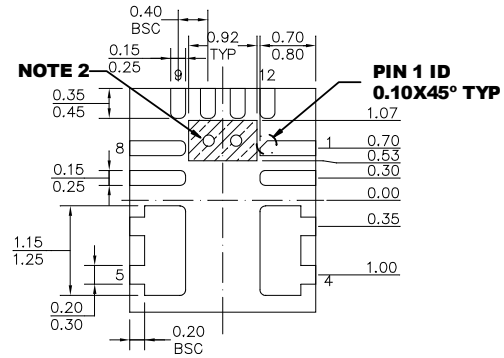

BOTTOM VIEW

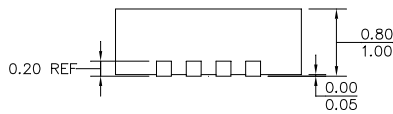

SIDE VIEW

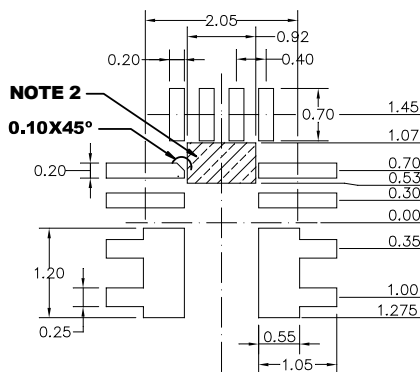

RECOMMENDED LAND PATTERN

NOTE:

- 1) ALL DIMENSIONS ARE IN MILLIMETERS.
- 2) SHADED AREA IS THE KEEP-OUT ZONE. ANY PCB METAL TRACE AND VIA ARE NOT ALLOWED TO CONNECT TO THIS AREA ELECTRICALLY OR MECHANICALLY.
- 3) EXPOSED PADDLE SIZE DOES NOT INCLUDE MOLD FLASH.
- 4) LEAD COPLANARITY SHALL BE 0.10 MILLIMETERS MAX.
- 5) JEDEC REFERENCE IS MO-220.
- 6) DRAWING IS NOT TO SCALE.

PACKAGE INFORMATION(continued)

QFN-12 (2.5mmx3.0mm)
MPM3810AGQBE

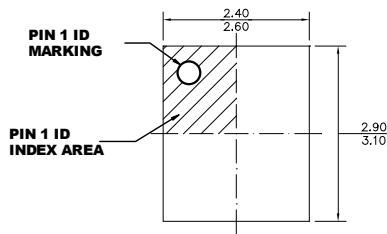

TOP VIEW

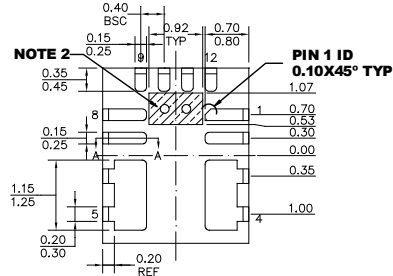

BOTTOM VIEW

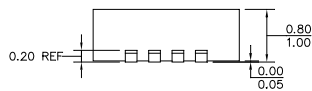

SIDE VIEW

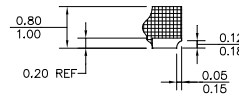

SECTION A-A

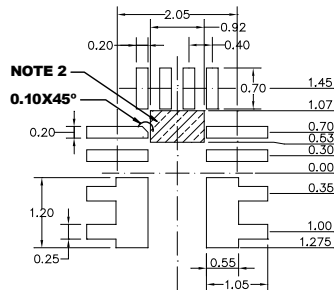

RECOMMENDED LAND PATTERN

NOTE:

- 1) ALL DIMENSIONS ARE IN MILLIMETERS.
- 2) SHADED AREA IS THE KEEP-OUT ZONE. ANY PCB METAL TRACE AND VIA ARE NOT ALLOWED TO CONNECT TO THIS AREA ELECTRICALLY OR MECHANICALLY.
- 3) EXPOSED PADDLE SIZE DOES NOT INCLUDE MOLD FLASH.
- 4) LEAD COPLANARITY SHALL BE 0.08 MILLIMETERS MAX.
- 5) JEDEC REFERENCE IS MO-220.
- 6) DRAWING IS NOT TO SCALE.

CARRIER INFORMATION

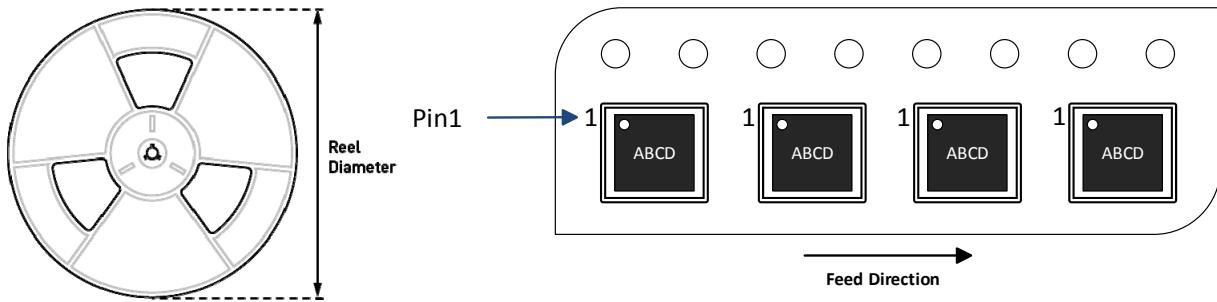

Part Number	Package Description	Quantity/ Reel	Quantity/ Tube	Quantity/ Tray	Reel Diameter	Carrier Tape Width	Carrier Tape Pitch
MPM3810AGQB- AEC1-Z	QFN-12 (2.5mmx3.0mmx0.9mm)	5000	N/A	N/A	13 in.	12 mm	8 mm
MPM3810AGQBE- AEC1-Z	QFN-12 (2.5mmx3.0mm)	5000	N/A	N/A	13 in.	12 mm	8 mm



Revision History

Revision #	Revision Date	Description	Pages Updated
1.0	11/1/2018	Initial Release	-
1.02	10/12/2020	Update MSL	P2
		Update ESD	P3
		Update Package information	P19/P20
		Add Carrier Information	P21

NOTICE: The information in this document is subject to change without notice. Please contact MPS for current specifications. Users should warrant and guarantee that third party Intellectual Property rights are not infringed upon when integrating MPS products into any application. MPS will not assume any legal responsibility for any said applications.