

# PXD10-Single Output DC/DC Converter

9 to 18 Vdc, 18 to 36 Vdc and 36 to 75 Vdc input, 3.3 to 15 Vdc Single Output, 10W

## TDK-Lambda



### Applications

- Distributed power architectures
- Computer equipment
- Communications equipment

### Features

- Single output current up to 2A
- 10 watts maximum output power
- 2:1 wide input voltage range of 9-18, 18-36 and 36-75VDC
- Six-sided continuous shield
- High efficiency up to 87%
- Low profile: 2.00×1.00×0.40 inches (50.8×25.4×10.2 mm )
- Fixed switching frequency
- RoHS compliant
- No minimum load
- Input to output isolation: 1600Vdc min
- Operating case temperature range: 100°C max
- Output over-voltage protection
- Over-current protection, auto-recovery
- Output short circuit protection

### Options

- Heat sinks available for extended operation
- Remote on/off and logic configuration

## General Description

The PXD10 single output series offers 10 watts of output power in a 2 X 1 X 0.4 inch package. It has a 2:1 wide input voltage of 9-18VDC, 18-36VDC and 36-75VDC, 1600VDC isolation, short circuit, over voltage protection, and six sided shielding. All models are particularly suited for telecommunications, industrial, mobile telecom and test equipment applications.

## Table of Contents

Absolute Maximum Rating	P2	Thermal Considerations	P33
Output Specification	P2	Remote ON/OFF Control	P34
Input Specification	P3	Heat Sink	P35
General Specification	P4	Mechanical Data	P35
Characteristic Curves	P5	Recommended Pad Layout	P36
Test Configurations	P29	Soldering Considerations	P36
EMC Consideration	P30	Packaging Information	P37
Input Source Impedance	P32	Part Number Structure	P37
Output Over Current Protection	P32	Safety and Installation Instructions	P38
Output Over Voltage Protection	P32	MTBF and Reliability	P38
Short Circuit Protection	P32		

Absolute Maximum Rating				
Parameter	Model	Min	Max	Unit
Input Voltage	Continuous	12Sxx	18	V <sub>DC</sub>
		24Sxx	36	
	Transient (100ms)	48Sxx	75	
		12Sxx	36	
24Sxx	50			
48Sxx	100			
Operating Ambient Temperature Standard (with derating)		-25	85	°C
Operating Case Temperature			100	°C
Storage Temperature	All	-55	105	°C

Output Specification					
Parameter	Model	Min	Typ	Max	Unit
Output Voltage Range (V <sub>in</sub> = V <sub>in</sub> (nom); Full Load ; T <sub>A</sub> =25 °C)	xxS3P3	3.267	3.3	3.333	V <sub>DC</sub>
	xxS05	4.95	5	5.05	
	xxS12	11.88	12	12.12	
	xxS15	14.85	15	15.15	
Output Regulation Line (V <sub>in</sub> (min) to V <sub>in</sub> (max) at Full Load) Load (0% to 100% of Full Load)	All			±0.2	%
				±0.5	
Output Ripple & Noise Peak -to- Peak (20MHz bandwidth)	All			50	mV <sub>P-P</sub>
Temperature Coefficient	All			±0.02	%/°C
Output Voltage Overshoot (V <sub>in</sub> (min) to V <sub>in</sub> (max); Full Load ; T <sub>A</sub> =25°C)	All		0	5	% V <sub>OUT</sub>
Dynamic Load Response (V <sub>in</sub> = V <sub>in</sub> (nom); T <sub>A</sub> =25°C) Load step change from 75% to 100% or 100 to 75% of Full Load Peak Deviation	All		200		mV
	All		250		µS
Output Current	xxS3P3	0		2000	mA
	xxS05	0		2000	
	xxS12	0		830	
	xxS15	0		670	
Output Over Voltage Protection (Zener diode clamp)	xxS3P3		3.9		V <sub>DC</sub>
	xxS05		6.2		
	xxS12		15		
	xxS15		18		
Output Over Current Protection	All		130	150	% FL.
Output Short Circuit Protection	All	Hiccup, automatic recovery			

Input Specification						
Parameter	Model	Min	Typ	Max	Unit	
Operating Input Voltage	12Sxx	9	12	18	Vdc	
	24Sxx	18	24	36		
	48Sxx	36	48	75		
Input Current (Maximum value at $V_{in} = V_{in(nom)}$ ; Full Load)	12S3P3			724	mA	
	12S05			1082		
	12S12			1037		
	12S15			1046		
	24S3P3			362		
	24S05			534		
	24S12			519		
	24S15			523		
	48S3P3			181		
	48S05			260		
	48S12			253		
48S15			252			
Input Standby current (Typical value at $V_{in} = V_{in(nom)}$ ; No Load)	12S3P3		17		mA	
	12S05		21			
	12S12		38			
	12S15		36			
	24S3P3		15			
	24S05		22			
	24S12		18			
	24S15		36			
	48S3P3		11			
	48S05		14			
	48S12		14			
48S15		10				
Input reflected ripple current (5 to 20MHz, 12 $\mu$ H source impedance)	All		30		mA <sub>P-P</sub>	
Start Up Time ( $V_{in} = V_{in(nom)}$ and constant resistive load) Power up	All		20		mS	
Remote On/Off Control (Option) (The On/Off pin voltage is referenced to $-V_{IN}$ ) Positive logic On/Off pin High Voltage (Remote On) On/Off pin Low Voltage (Remote Off) Negative logic On/Off pin High Voltage (Remote On) On/Off pin Low Voltage (Remote Off)	Suffix -P	3.5		12	V <sub>DC</sub>	
	Suffix -P	0		1.2		
	Suffix -N	0		1.2		
	Suffix -N	3.5		12		
	All		20			mA
	All	-0.5		1		mA

General Specification					
Parameter	Model	Min	Typ	Max	Unit
Efficiency ( $V_{in} = V_{in(nom)}$ ; Full Load ; $T_A=25^\circ\text{C}$ )	12S3P3		80		%
	12S05		81		
	12S12		84		
	12S15		84		
	24S3P3		80		
	24S05		82		
	24S12		84		
	24S15		84		
	48S3P3		80		
	48S05		84		
	48S12		86		
	48S15		87		
	Isolation voltage Input to Output Input to Case, Output to Case	All	1600 1600		
Isolation resistance	All	1			$G\Omega$
Isolation capacitance	All			300	pF
Switching Frequency	All		300		kHz
Weight	All		27.0		g
MTBF Bellcore TR-NWT-000332, $T_C=40^\circ\text{C}$ MIL-HDBK-217F	All		$1.976 \times 10^6$ $1.416 \times 10^6$		hours

Characteristic Curves

All test conditions are at 25°C. The figures are for PXD10-12S3P3

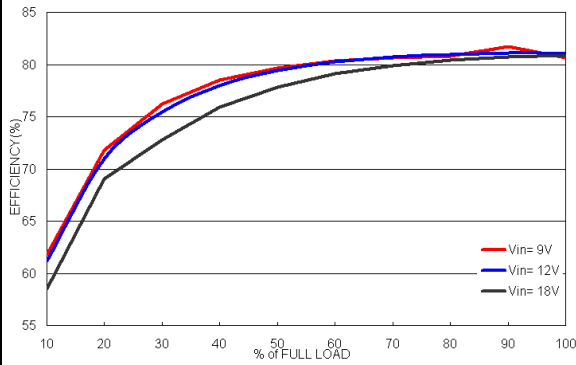

Efficiency versus Output Current

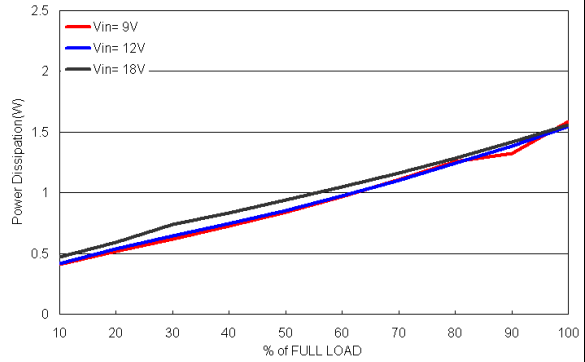

Power Dissipation versus Output Current

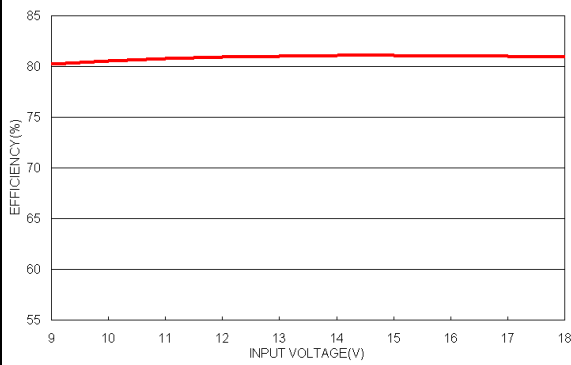

Efficiency versus Input Voltage. Full Load

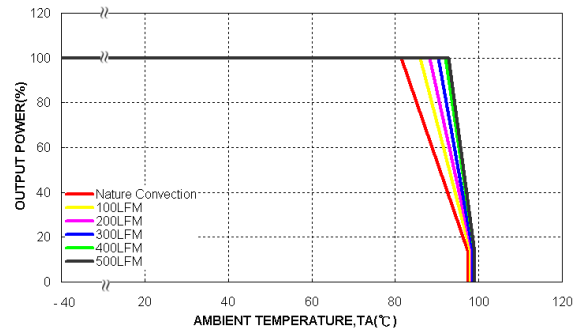

Derating Output Current versus Ambient Temperature and Airflow  
Vin = Vin(nom)

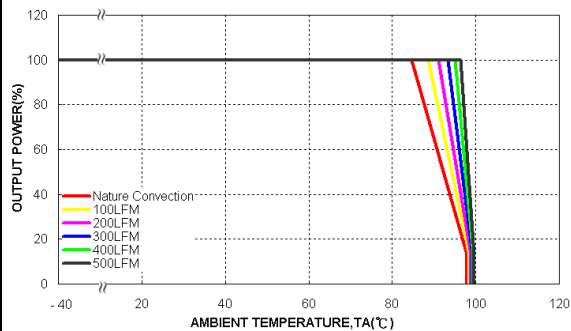

Derating Output Current Versus Ambient Temperature with Heat-Sink  
and Airflow, Vin = Vin(nom)

Characteristic Curves (Continued)

All test conditions are at 25°C. The figures are for PXD10-12S3P3

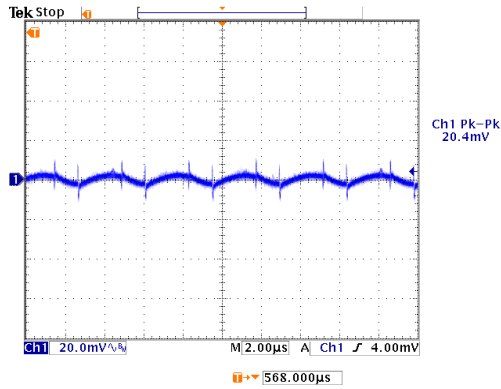

Typical Output Ripple and Noise.  
Vin = Vin(nom); Full Load

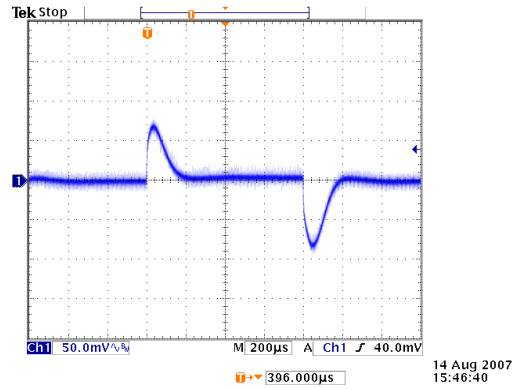

Transient Response to Dynamic Load Change from 100% to 75% to 100% of Full Load ; Vin = Vin(nom)

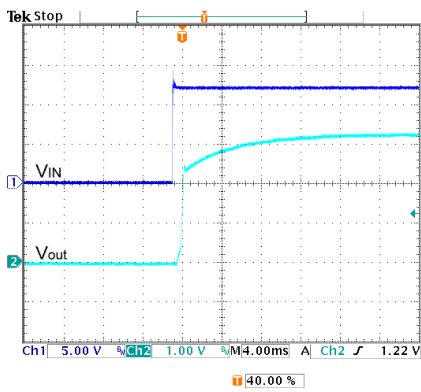

Typical Input Start-up and Output Rise Characteristic  
Vin = Vin(nom) ; Full Load

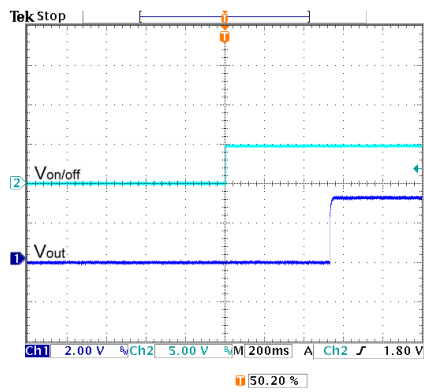

Using ON/OFF Voltage Start-up and Vo Rise Characteristic  
Vin = Vin(nom) ; Full Load

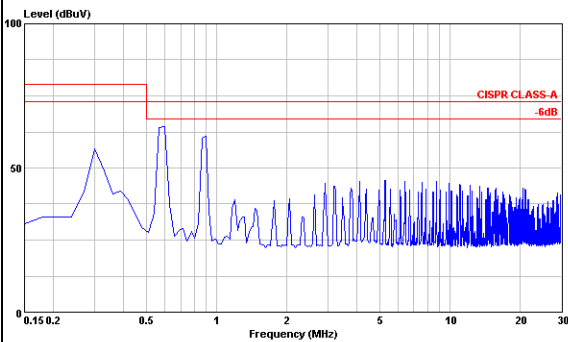

Conduction Emission of EN55022 Class A  
Vin = Vin(nom) ; Full Load

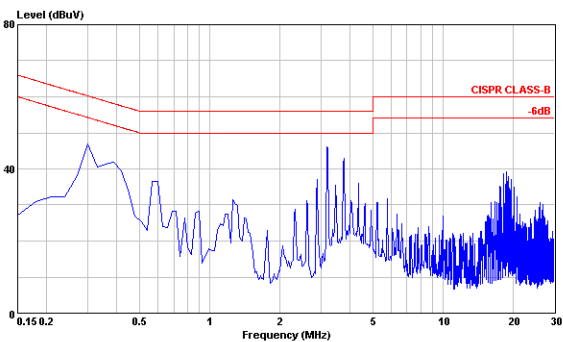

Conduction Emission of EN55022 Class B  
Vin = Vin(nom) ; Full Load

Characteristic Curves (Continued)

All test conditions are at 25°C. The figures are for PXD10-12S05

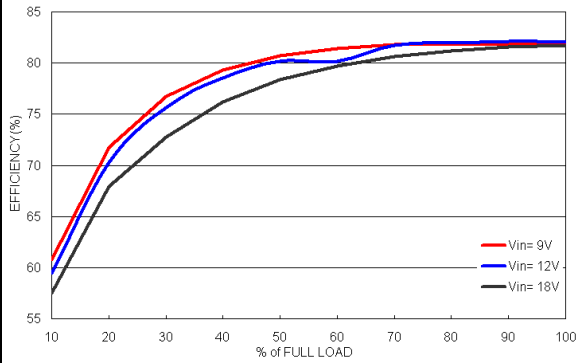

Efficiency versus Output Current

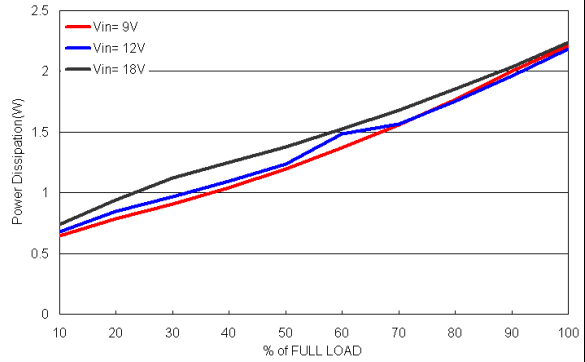

Power Dissipation versus Output Current

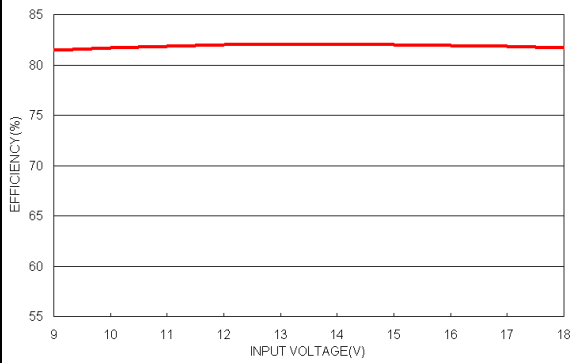

Efficiency versus Input Voltage. Full Load

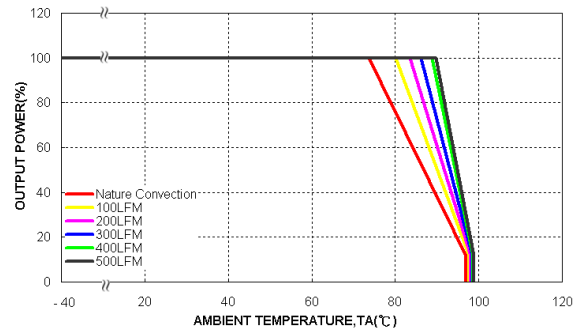

Derating Output Current versus Ambient Temperature and Airflow  
Vin = Vin(nom)

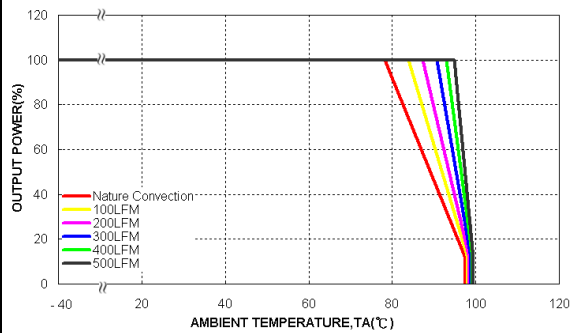

Derating Output Current Versus Ambient Temperature with Heat-Sink  
and Airflow, Vin = Vin(nom)

Characteristic Curves (Continued)

All test conditions are at 25°C. The figures are for PXD10-12S05

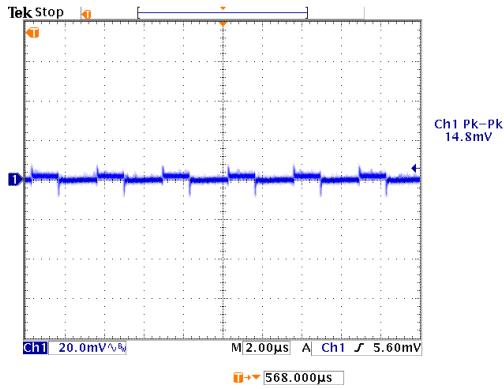

Typical Output Ripple and Noise.  
Vin = Vin(nom); Full Load

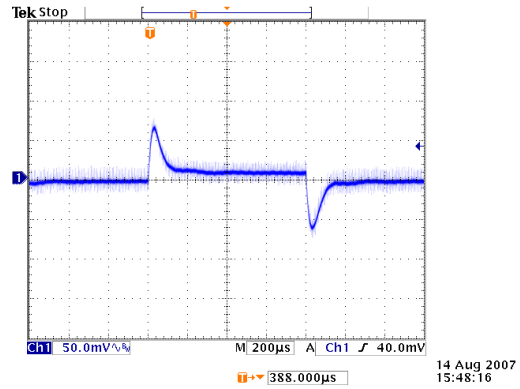

Transient Response to Dynamic Load Change from  
100% to 75% to 100% of Full Load ; Vin = Vin(nom)

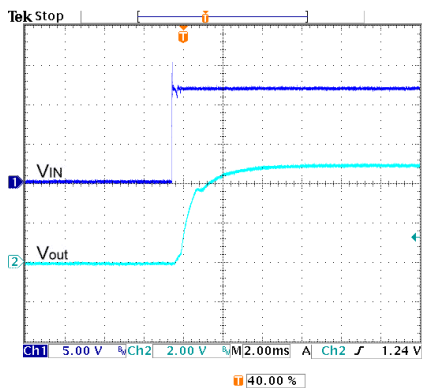

Typical Input Start-up and Output Rise Characteristic  
Vin = Vin(nom) ; Full Load

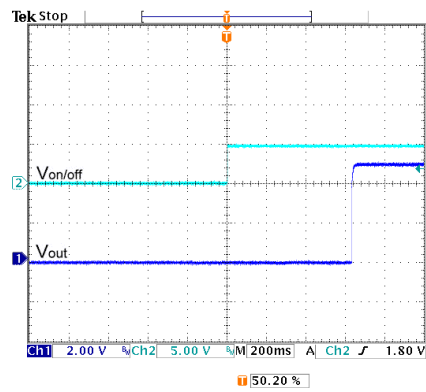

Using ON/OFF Voltage Start-up and Vo Rise Characteristic  
Vin = Vin(nom) ; Full Load

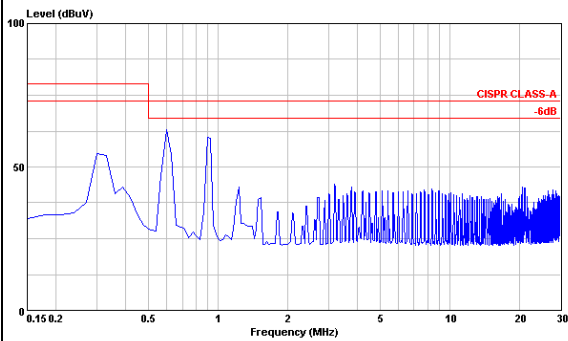

Conduction Emission of EN55022 Class A  
Vin = Vin(nom) ; Full Load

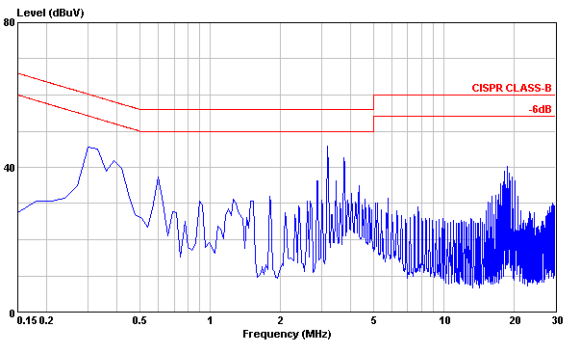

Conduction Emission of EN55022 Class B  
Vin = Vin(nom) ; Full Load



Characteristic Curves (Continued)

All test conditions are at 25°C. The figures are for PXD10-12S12

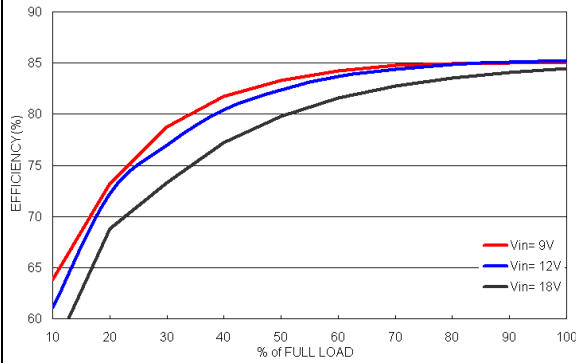

Efficiency versus Output Current

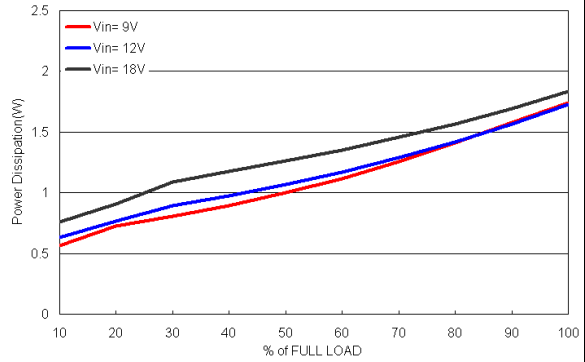

Power Dissipation versus Output Current

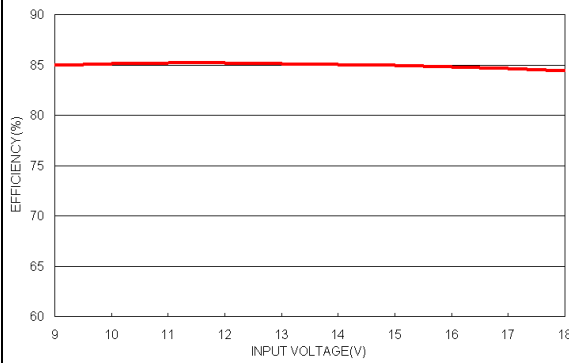

Efficiency versus Input Voltage. Full Load

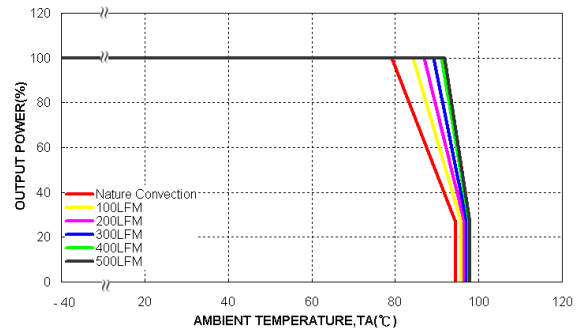

Derating Output Current versus Ambient Temperature and Airflow  
Vin = Vin(nom)

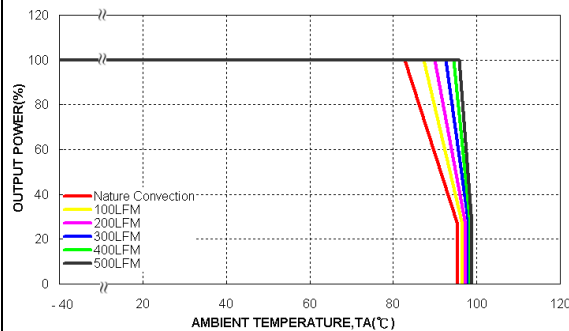

Derating Output Current Versus Ambient Temperature with Heat-Sink and Airflow, Vin = Vin(nom)

Characteristic Curves (Continued)

All test conditions are at 25°C. The figures are for PXD10-12S12

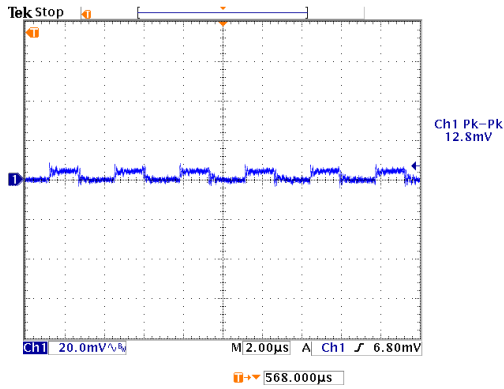

Typical Output Ripple and Noise.  
Vin = Vin(nom) ; Full Load

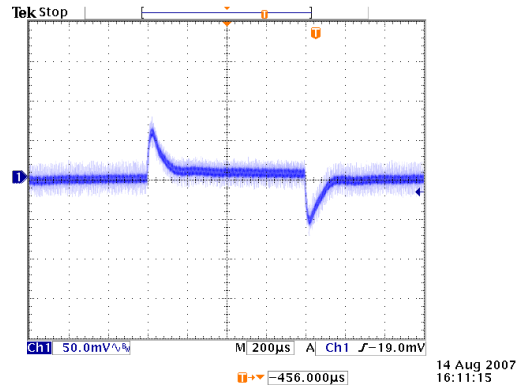

Transient Response to Dynamic Load Change from  
100% to 75% to 100% of Full Load ; Vin = Vin(nom)

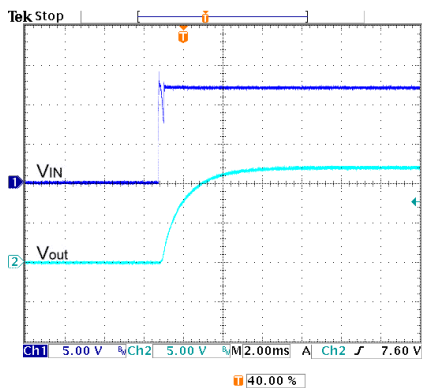

Typical Input Start-up and Output Rise Characteristic  
Vin = Vin(nom) ; Full Load

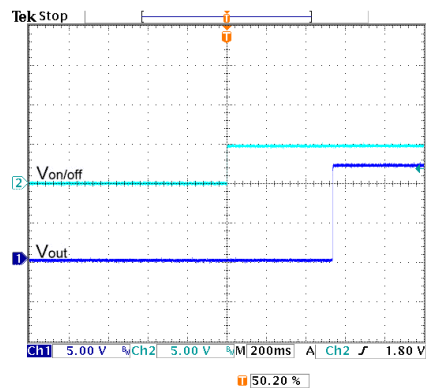

Using ON/OFF Voltage Start-up and Vo Rise Characteristic  
Vin = Vin(nom) ; Full Load

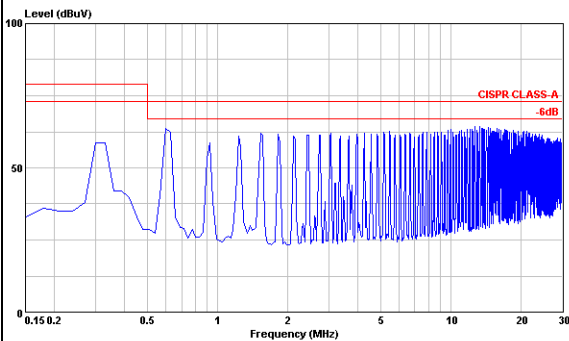

Conduction Emission of EN55022 Class A  
Vin = Vin(nom) ; Full Load

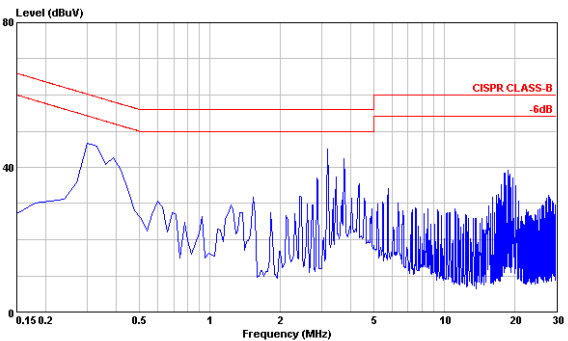

Conduction Emission of EN55022 Class B  
Vin = Vin(nom) ; Full Load

Characteristic Curves (Continued)

All test conditions are at 25°C. The figures are for PXD10-12S15

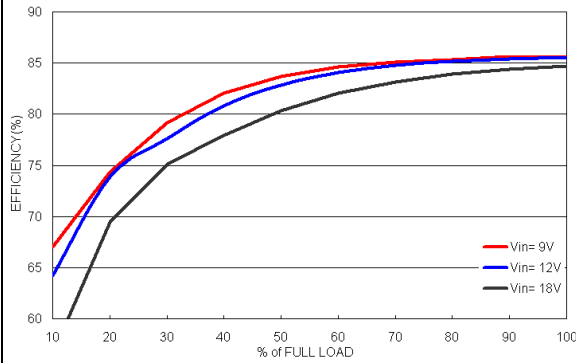

Efficiency versus Output Current

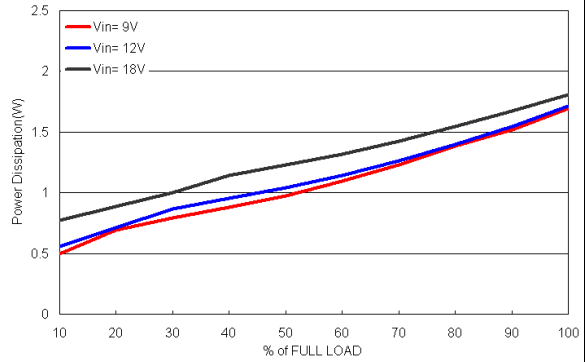

Power Dissipation versus Output Current

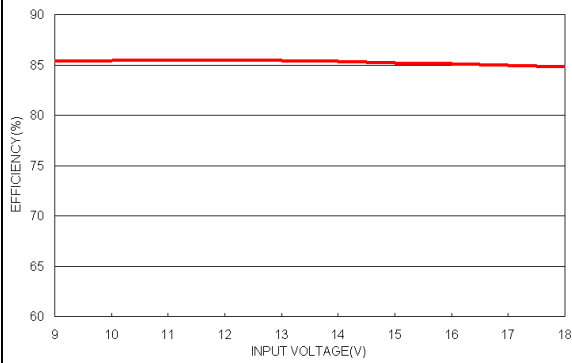

Efficiency versus Input Voltage. Full Load

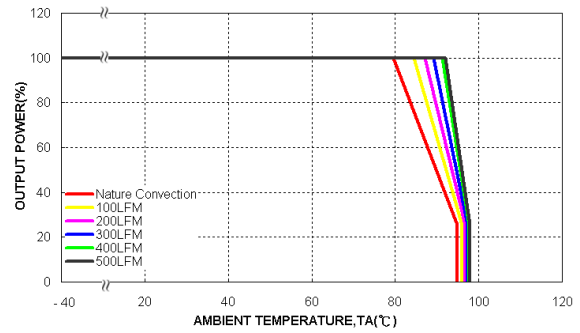

Derating Output Current versus Ambient Temperature and Airflow  
Vin = Vin(nom)

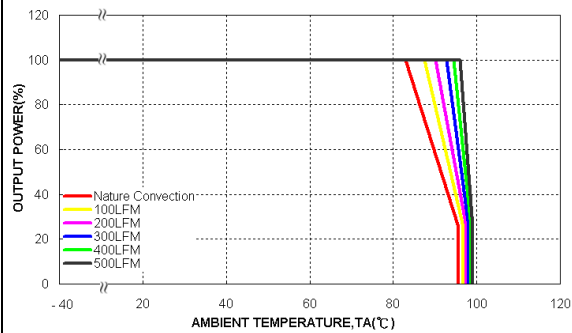

Derating Output Current Versus Ambient Temperature with Heat-Sink  
and Airflow, Vin = Vin(nom)

Characteristic Curves (Continued)

All test conditions are at 25°C. The figures are for PXD10-12S15

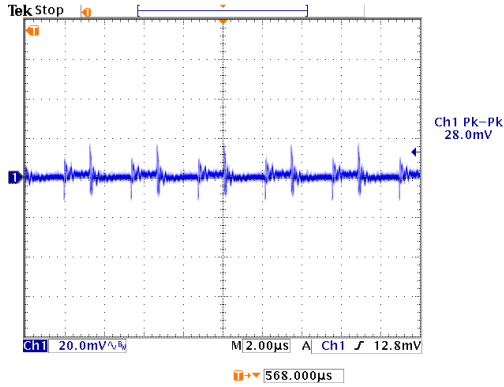

Typical Output Ripple and Noise.  
 $V_{in} = V_{in(nom)}$  ; Full Load

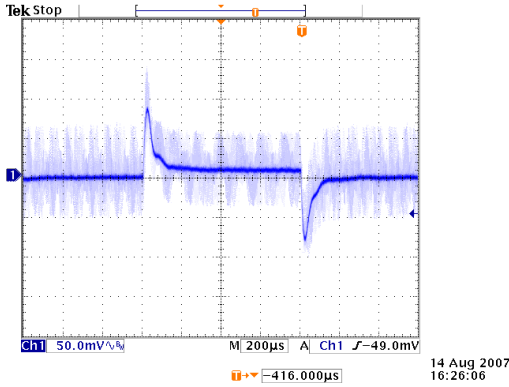

Transient Response to Dynamic Load Change from  
 100% to 75% to 100% of Full Load ;  $V_{in} = V_{in(nom)}$

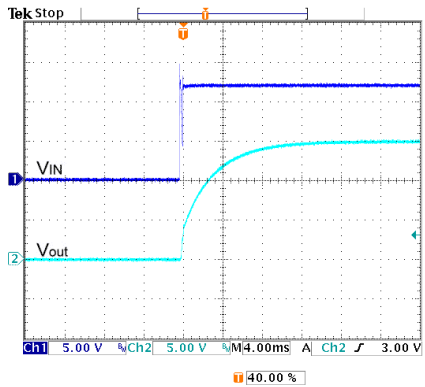

Typical Input Start-up and Output Rise Characteristic  
 $V_{in} = V_{in(nom)}$  ; Full Load

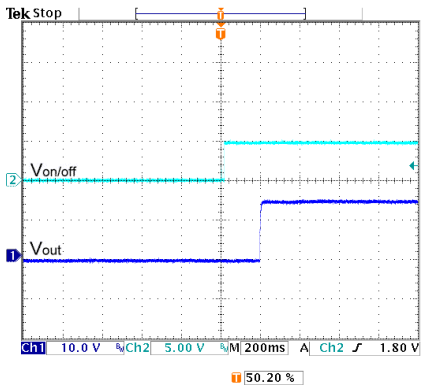

Using ON/OFF Voltage Start-up and  $V_o$  Rise Characteristic  
 $V_{in} = V_{in(nom)}$  ; Full Load

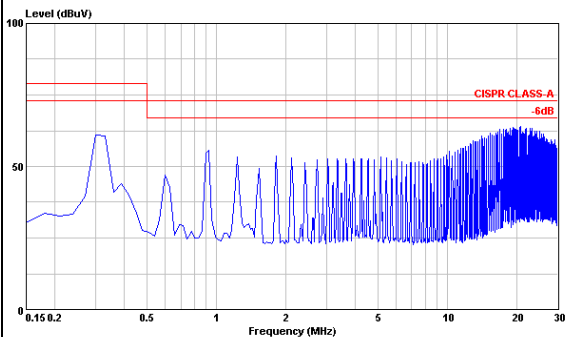

Conduction Emission of EN55022 Class A  
 $V_{in} = V_{in(nom)}$  ; Full Load

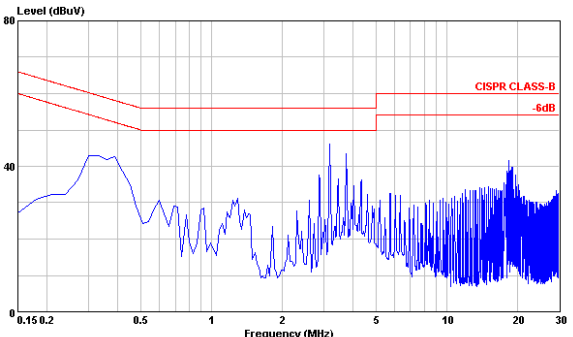

Conduction Emission of EN55022 Class B  
 $V_{in} = V_{in(nom)}$  ; Full Load

Characteristic Curves (Continued)

All test conditions are at 25°C. The figures are for PXD10-24S3P3

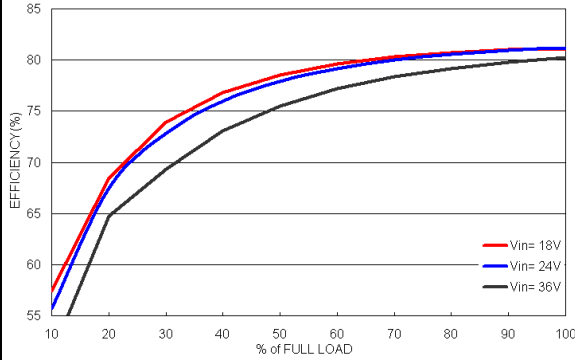

Efficiency versus Output Current

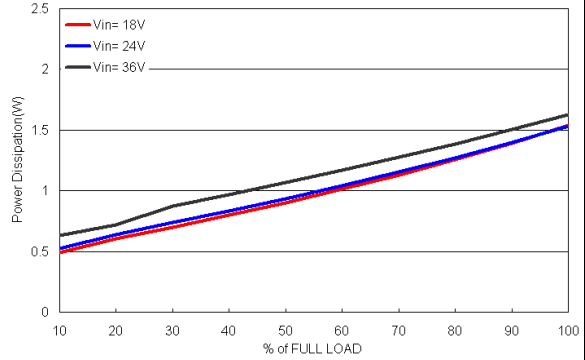

Power Dissipation versus Output Current

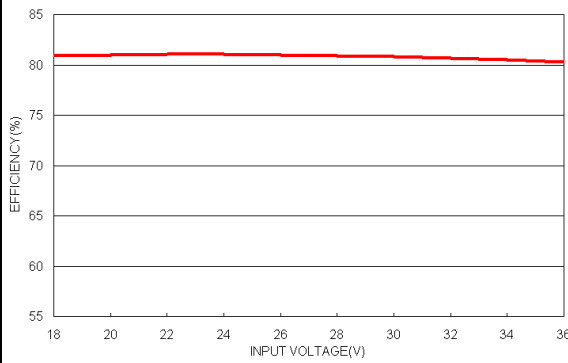

Efficiency versus Input Voltage. Full Load

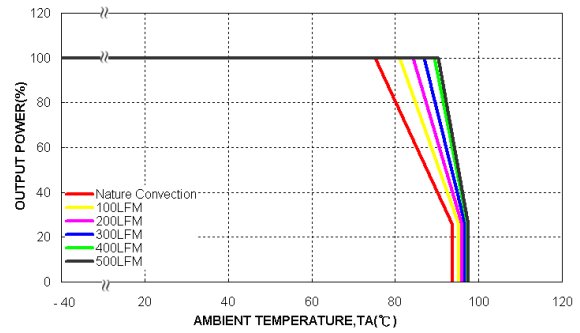

Derating Output Current versus Ambient Temperature and Airflow  
Vin = Vin(nom)

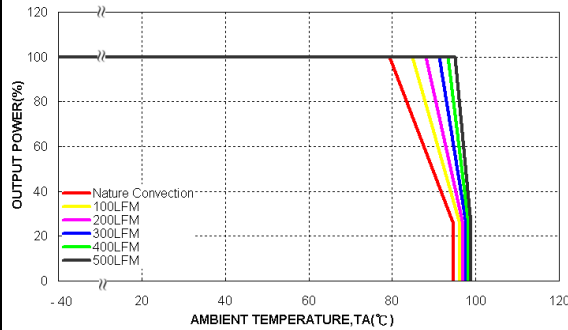

Derating Output Current Versus Ambient Temperature with Heat-Sink and Airflow, Vin = Vin(nom)

Characteristic Curves (Continued)

All test conditions are at 25°C. The figures are for PXD10-24S3P3

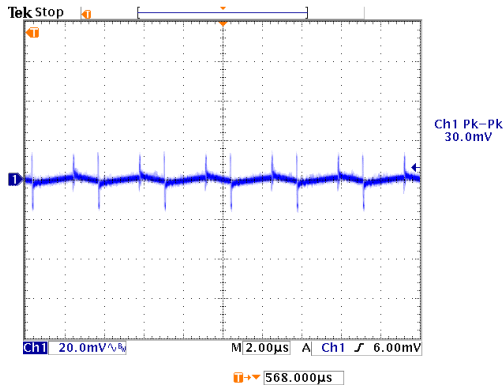

Typical Output Ripple and Noise.  
 $V_{in} = V_{in(nom)}$  ; Full Load

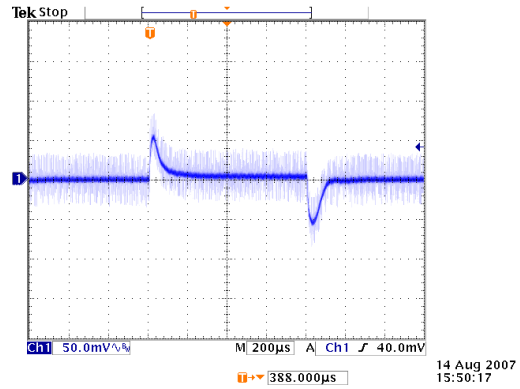

Transient Response to Dynamic Load Change from  
 100% to 75% to 100% of Full Load ;  $V_{in} = V_{in(nom)}$

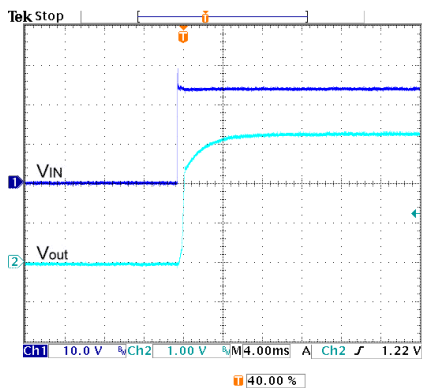

Typical Input Start-up and Output Rise Characteristic  
 $V_{in} = V_{in(nom)}$  ; Full Load

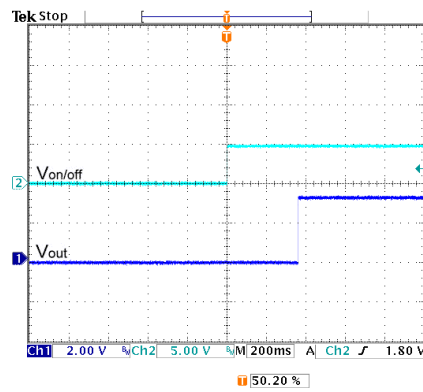

Using ON/OFF Voltage Start-up and  $V_o$  Rise Characteristic  
 $V_{in} = V_{in(nom)}$  ; Full Load

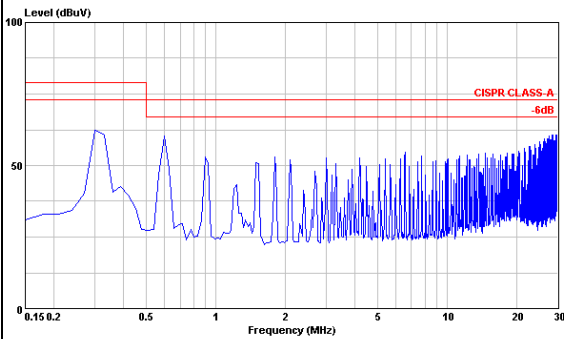

Conduction Emission of EN55022 Class A  
 $V_{in} = V_{in(nom)}$  ; Full Load

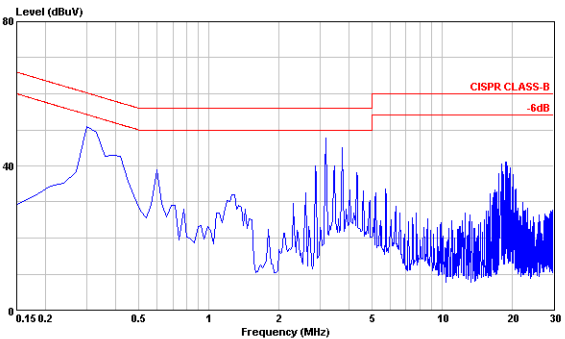

Conduction Emission of EN55022 Class B  
 $V_{in} = V_{in(nom)}$  ; Full Load

Characteristic Curves (Continued)

All test conditions are at 25°C. The figures are for PXD10-24S05

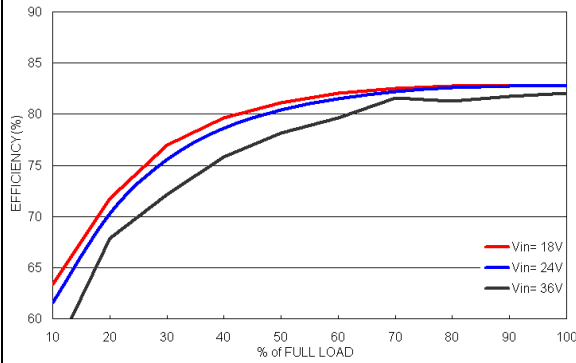

Efficiency versus Output Current

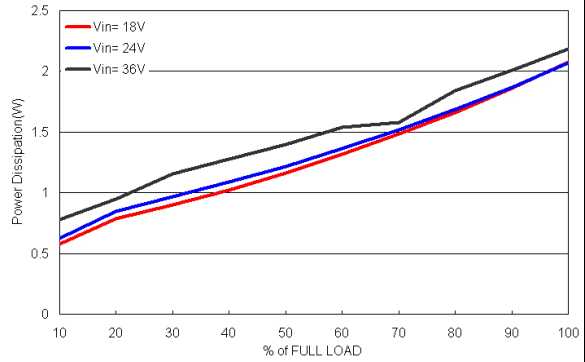

Power Dissipation versus Output Current

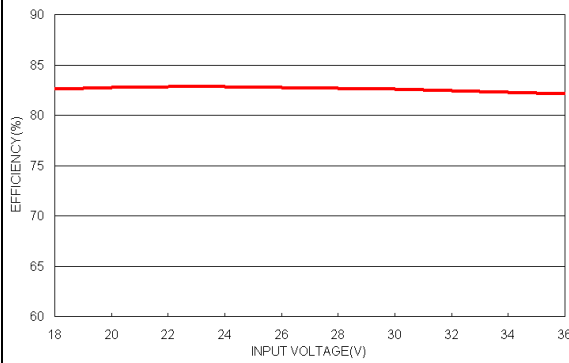

Efficiency versus Input Voltage. Full Load

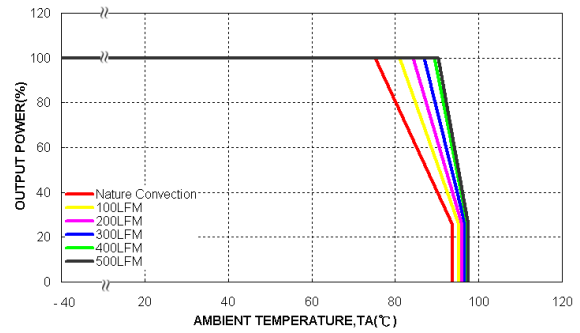

Derating Output Current versus Ambient Temperature and Airflow  
Vin = Vin(nom)

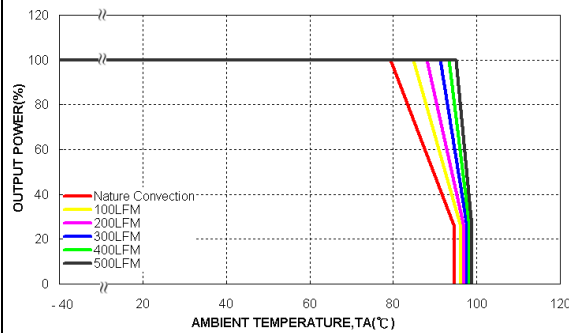

Derating Output Current Versus Ambient Temperature with Heat-Sink  
and Airflow, Vin = Vin(nom)

Characteristic Curves (Continued)

All test conditions are at 25°C. The figures are for PXD10-24S05

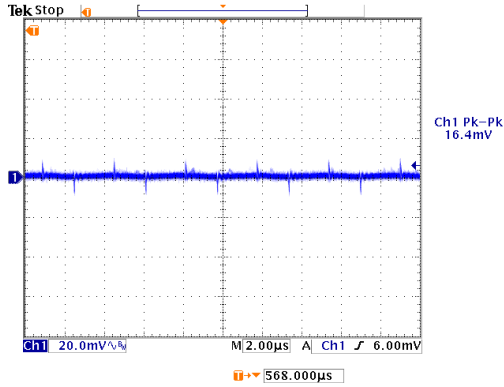

Typical Output Ripple and Noise.  
 $V_{in} = V_{in(nom)}$  ; Full Load

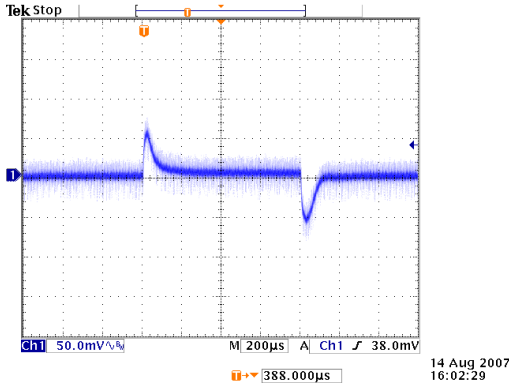

Transient Response to Dynamic Load Change from  
 100% to 75% to 100% of Full Load ;  $V_{in} = V_{in(nom)}$

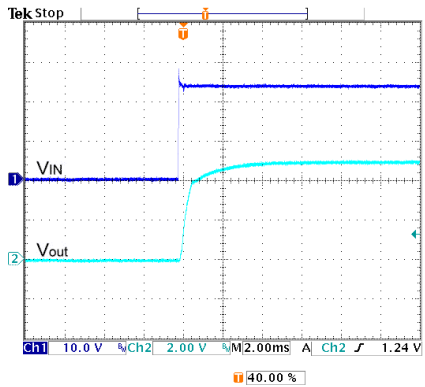

Typical Input Start-up and Output Rise Characteristic  
 $V_{in} = V_{in(nom)}$  ; Full Load

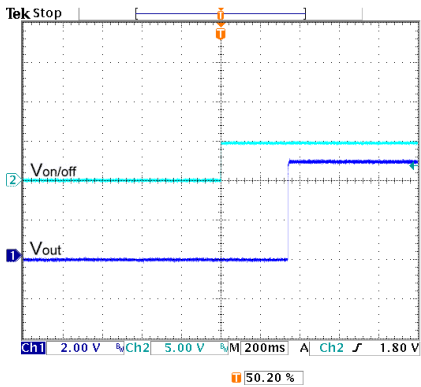

Using ON/OFF Voltage Start-up and  $V_o$  Rise Characteristic  
 $V_{in} = V_{in(nom)}$  ; Full Load

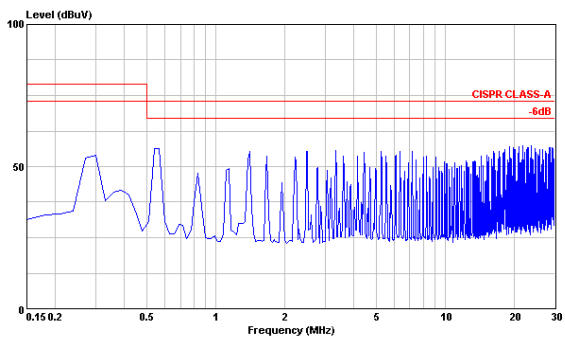

Conduction Emission of EN55022 Class A  
 $V_{in} = V_{in(nom)}$  ; Full Load

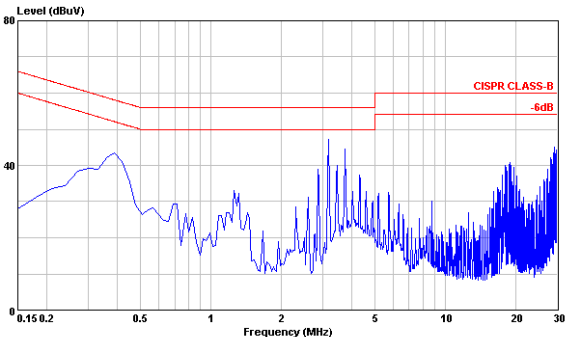

Conduction Emission of EN55022 Class B  
 $V_{in} = V_{in(nom)}$  ; Full Load



Characteristic Curves (Continued)

All test conditions are at 25°C. The figures are for PXD10-24S12

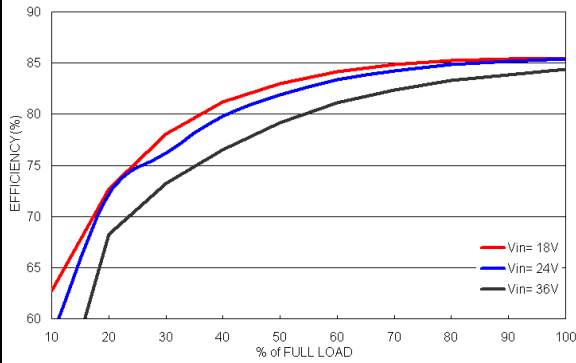

Efficiency versus Output Current

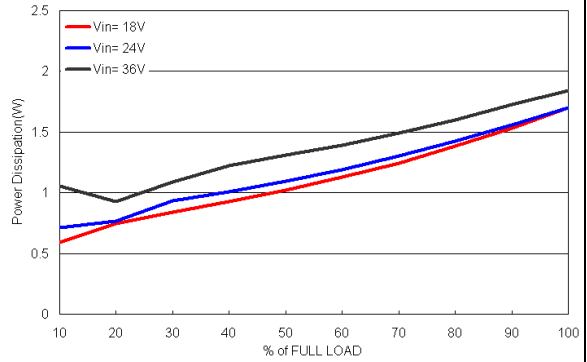

Power Dissipation versus Output Current

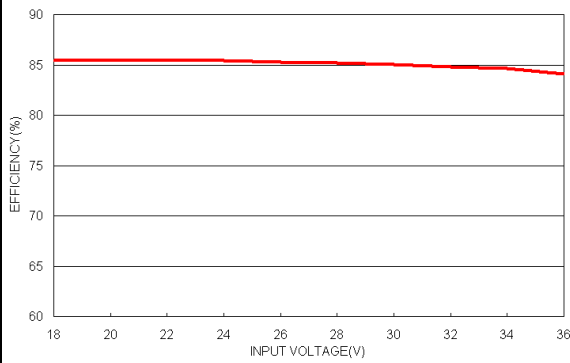

Efficiency versus Input Voltage. Full Load

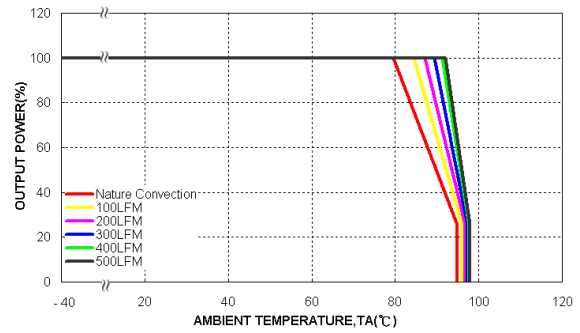

Derating Output Current versus Ambient Temperature and Airflow  
Vin = Vin(nom)

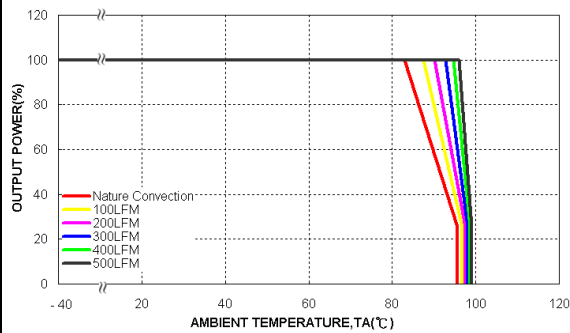

Derating Output Current Versus Ambient Temperature with Heat-Sink  
and Airflow, Vin = Vin(nom)

Characteristic Curves (Continued)

All test conditions are at 25°C. The figures are for PXD10-24S12

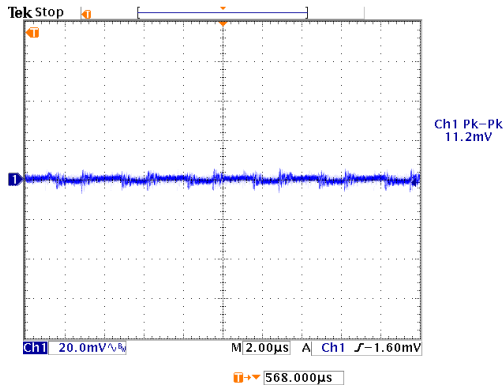

Typical Output Ripple and Noise.  
 $V_{in} = V_{in(nom)}$  ; Full Load

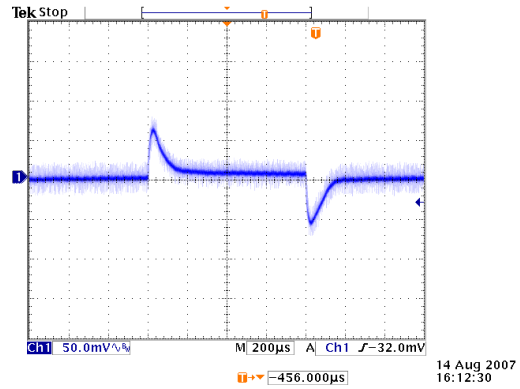

Transient Response to Dynamic Load Change from  
 100% to 75% to 100% of Full Load ;  $V_{in} = V_{in(nom)}$

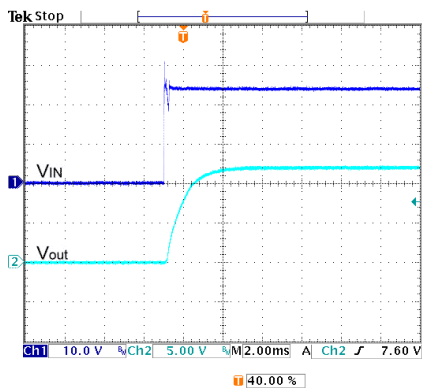

Typical Input Start-Up and Output Rise Characteristic  
 $V_{in} = V_{in(nom)}$  ; Full Load

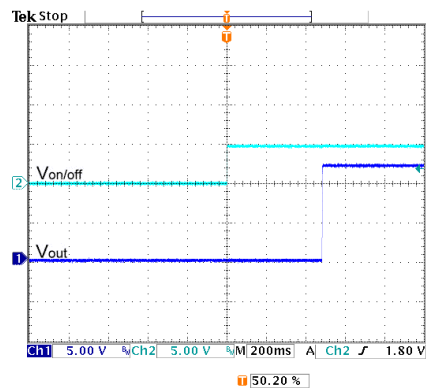

Using ON/OFF Voltage Start-Up and  $V_o$  Rise Characteristic  
 $V_{in} = V_{in(nom)}$  ; Full Load

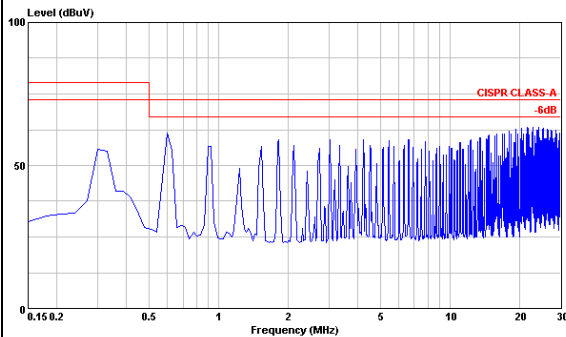

Conduction Emission of EN55022 Class A  
 $V_{in} = V_{in(nom)}$  ; Full Load

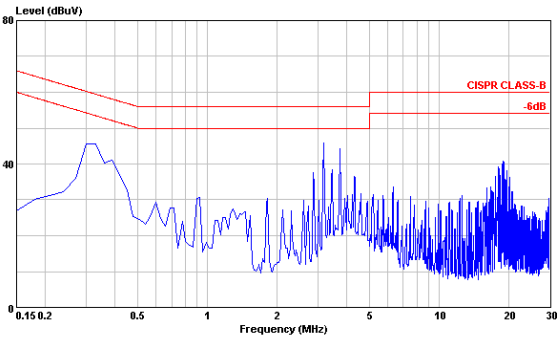

Conduction Emission of EN55022 Class B  
 $V_{in} = V_{in(nom)}$  ; Full Load

Characteristic Curves (Continued)

All test conditions are at 25°C. The figures are for PXD10-24S15

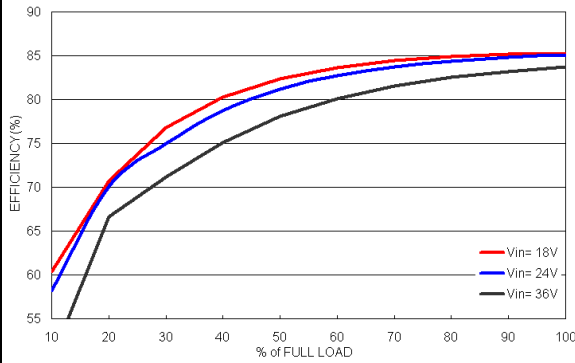

Efficiency versus Output Current

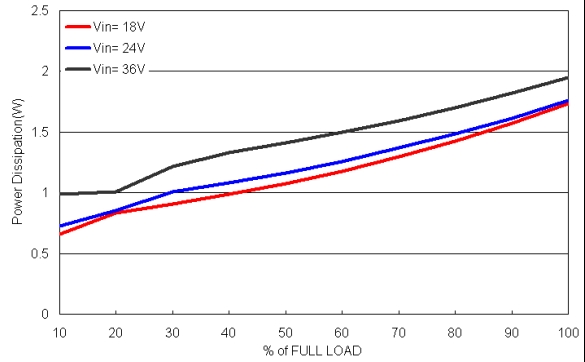

Power Dissipation versus Output Current

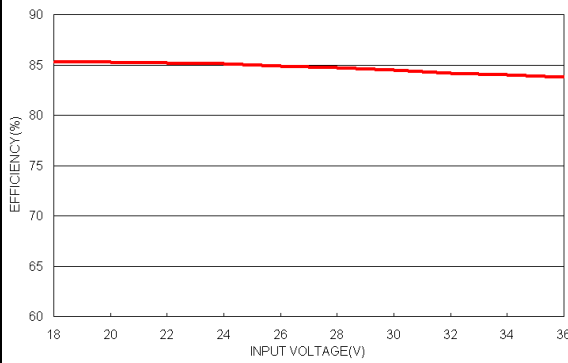

Efficiency versus Input Voltage. Full Load

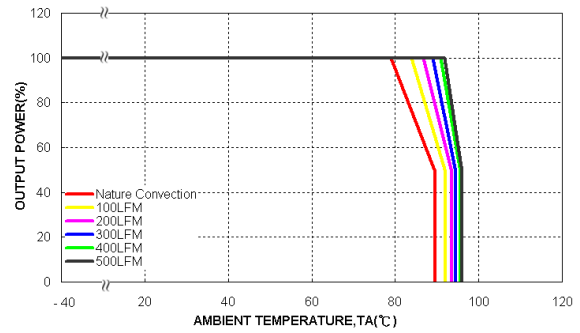

Derating Output Current versus Ambient Temperature and Airflow  
Vin = Vin(nom)

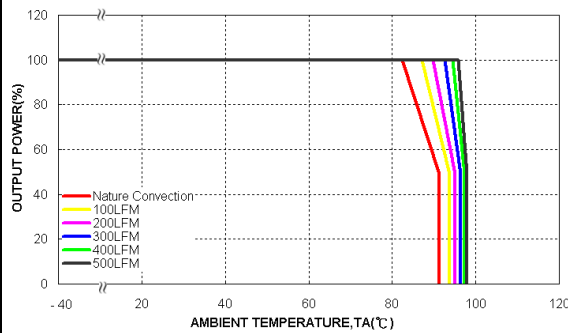

Derating Output Current Versus Ambient Temperature with Heat-Sink  
and Airflow, Vin = Vin(nom)

Characteristic Curves (Continued)

All test conditions are at 25°C. The figures are for PXD10-24S15

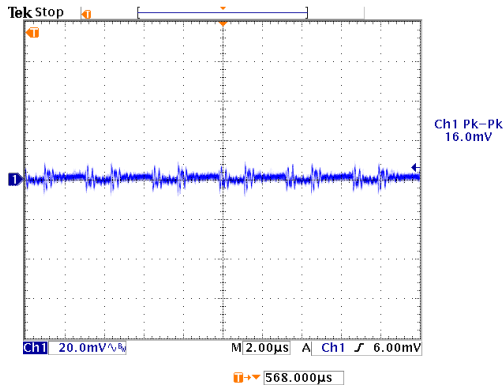

Typical Output Ripple and Noise.  
Vin = Vin(nom) ; Full Load

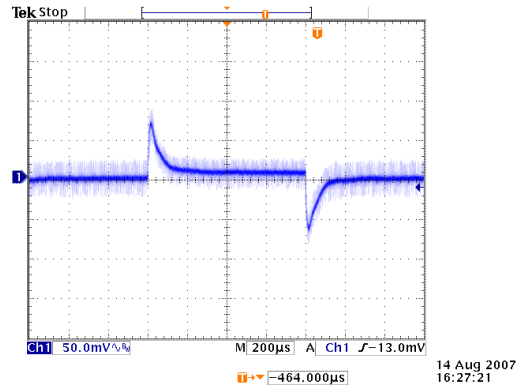

Transient Response to Dynamic Load Change from  
100% to 75% to 100% of Full Load ; Vin = Vin(nom)

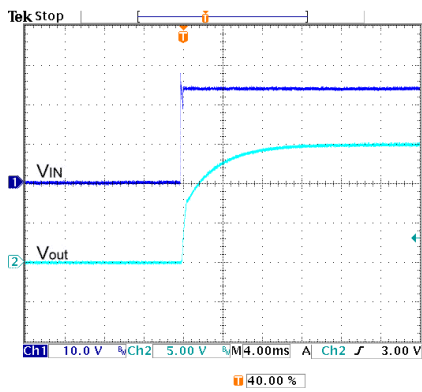

Typical Input Start-up and Output Rise Characteristic  
Vin = Vin(nom) ; Full Load

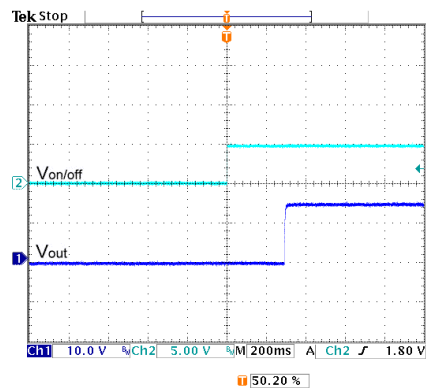

Using ON/OFF Voltage Start-up and Vo Rise Characteristic  
Vin = Vin(nom) ; Full Load

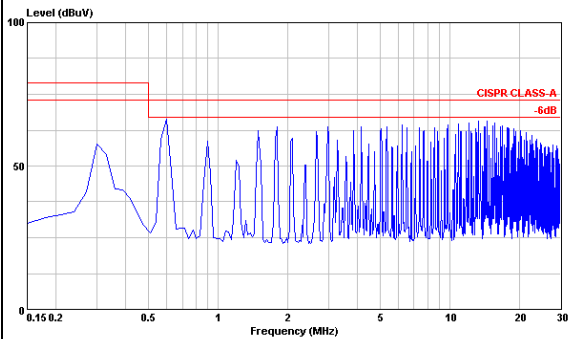

Conduction Emission of EN55022 Class A  
Vin = Vin(nom) ; Full Load

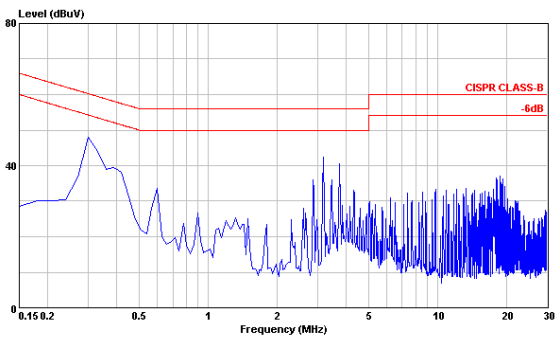

Conduction Emission of EN55022 Class B  
Vin = Vin(nom) ; Full Load

Characteristic Curves (Continued)

All test conditions are at 25°C. The figures are for PXD10-48S3P3

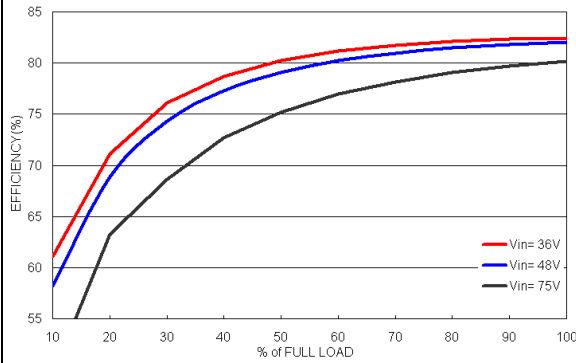

Efficiency versus Output Current

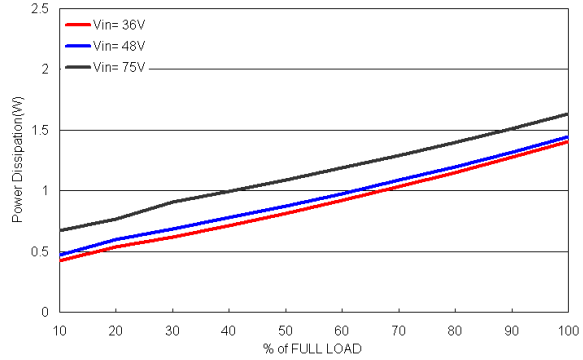

Power Dissipation versus Output Current

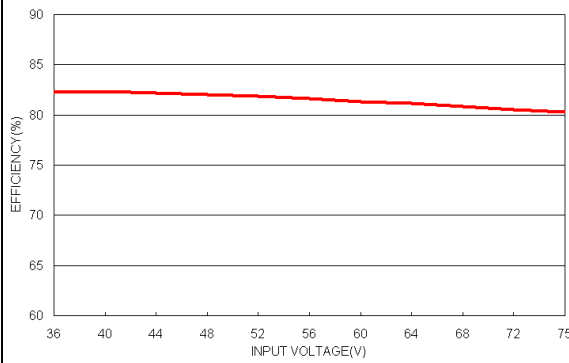

Efficiency versus Input Voltage. Full Load

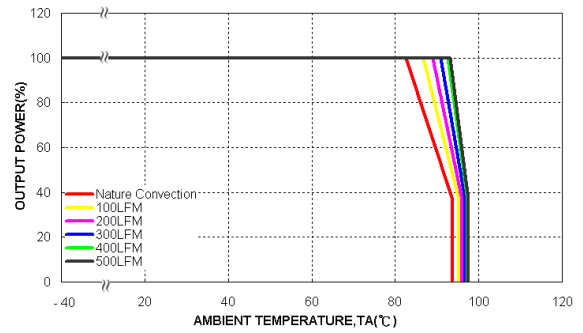

Derating Output Current versus Ambient Temperature and Airflow  
Vin = Vin(nom)

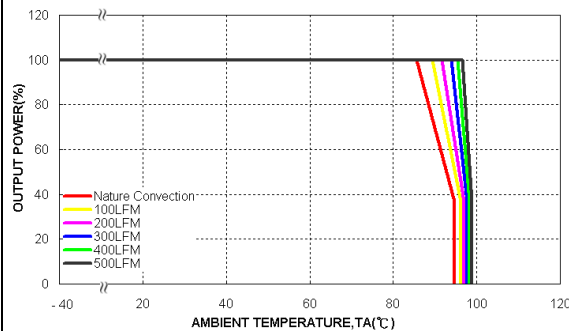

Derating Output Current Versus Ambient Temperature with Heat-Sink  
and Airflow, Vin = Vin(nom)

Characteristic Curves (Continued)

All test conditions are at 25°C. The figures are for PXD10-48S3P3

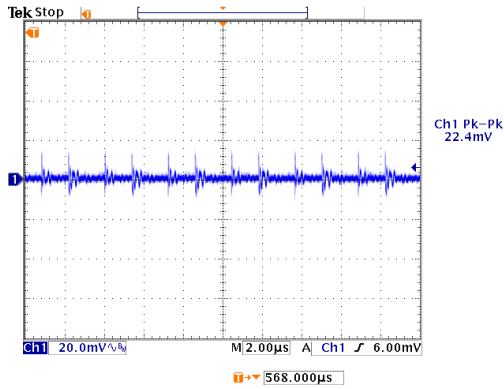

Typical Output Ripple and Noise.  
Vin = Vin(nom) ; Full Load

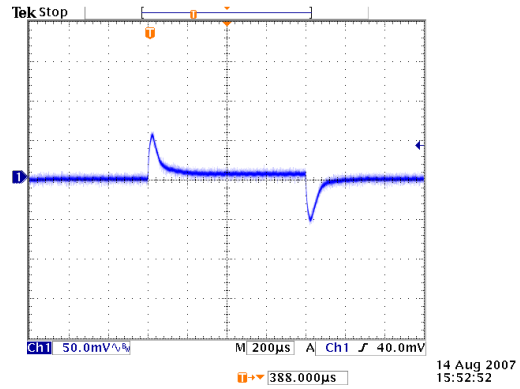

Transient Response to Dynamic Load Change from  
100% to 75% to 100% of Full Load ; Vin = Vin(nom)

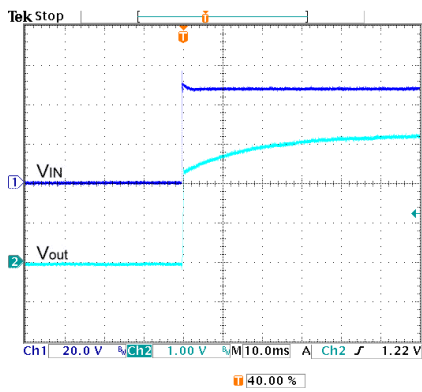

Typical Input Start-Up and Output Rise Characteristic  
Vin = Vin(nom) ; Full Load

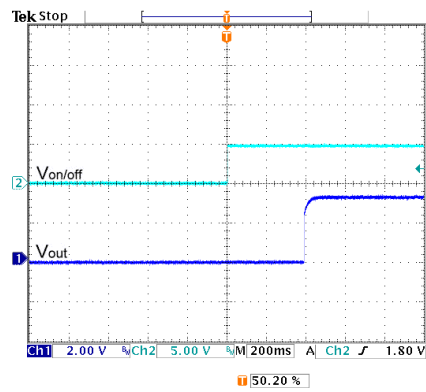

Using ON/OFF Voltage Start-Up and Vo Rise Characteristic  
Vin = Vin(nom) ; Full Load

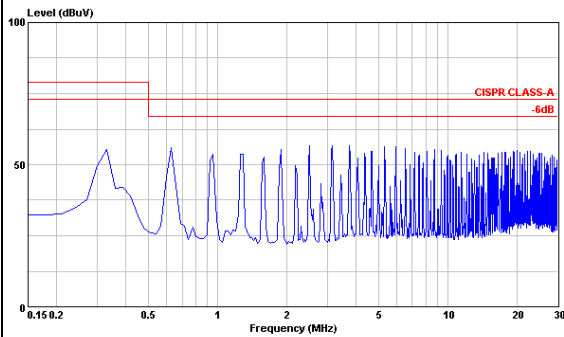

Conduction Emission of EN55022 Class A  
Vin = Vin(nom) ; Full Load

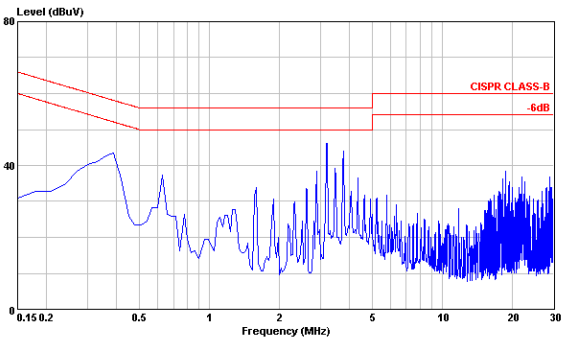

Conduction Emission of EN55022 Class B  
Vin = Vin(nom) ; Full Load

Characteristic Curves (Continued)

All test conditions are at 25°C. The figures are for PXD10-48S05

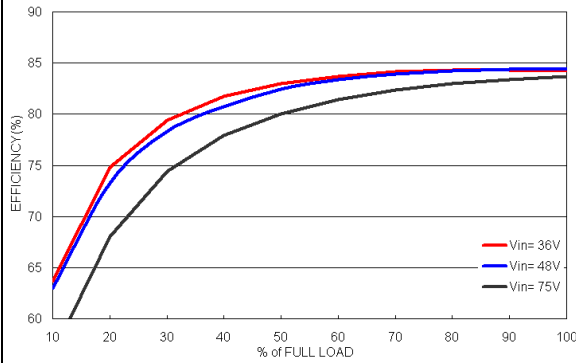

Efficiency versus Output Current

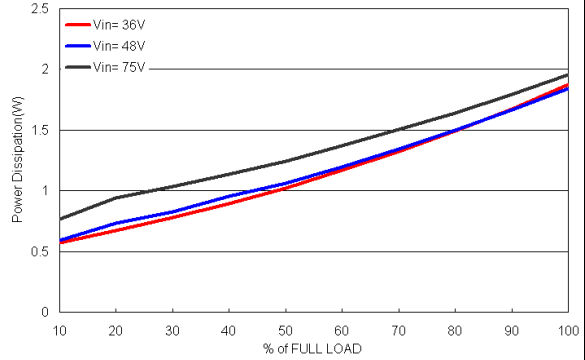

Power Dissipation versus Output Current

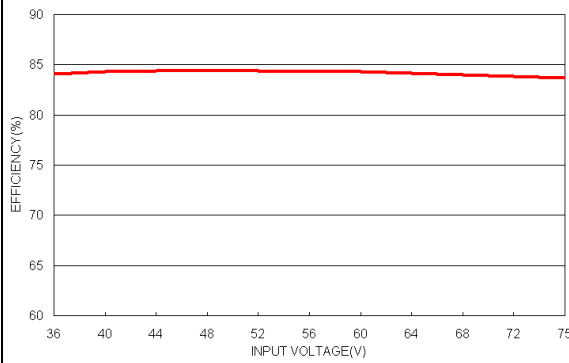

Efficiency versus Input Voltage. Full Load

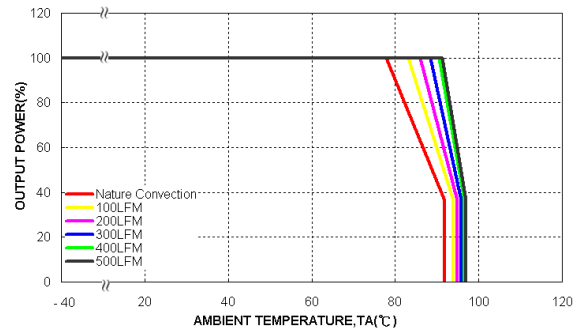

Derating Output Current versus Ambient Temperature and Airflow  
Vin = Vin(nom)

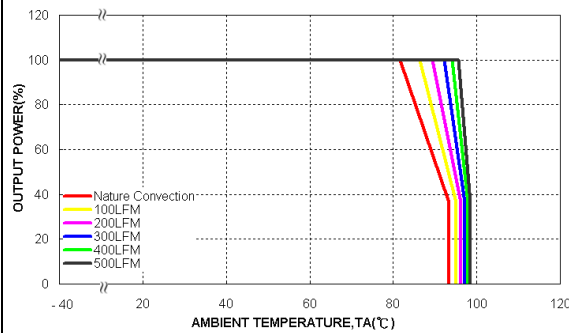

Derating Output Current Versus Ambient Temperature with Heat-Sink and Airflow, Vin = Vin(nom)

Characteristic Curves (Continued)

All test conditions are at 25°C. The figures are for PXD10-48S05

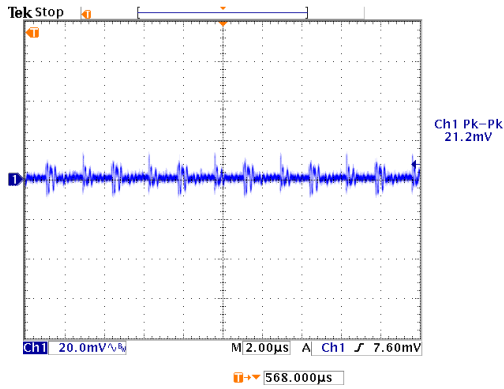

Typical Output Ripple and Noise.  
 $V_{in} = V_{in}(nom)$  ; Full Load

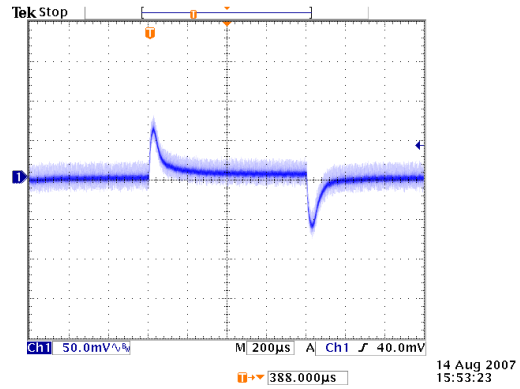

Transient Response to Dynamic Load Change from  
 100% to 75% to 100% of Full Load ;  $V_{in} = V_{in}(nom)$

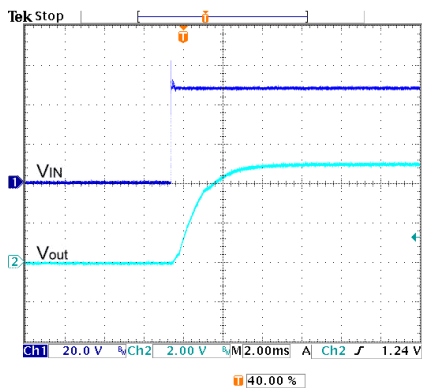

Typical Input Start-up and Output Rise Characteristic  
 $V_{in} = V_{in}(nom)$  ; Full Load

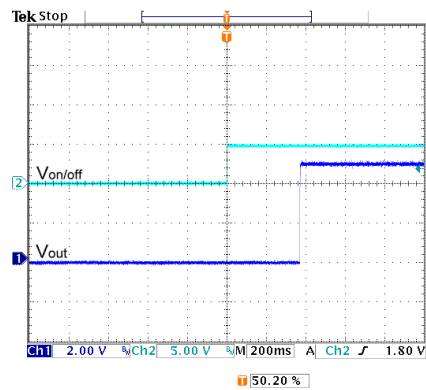

Using ON/OFF Voltage Start-up and  $V_o$  Rise Characteristic  
 $V_{in} = V_{in}(nom)$  ; Full Load

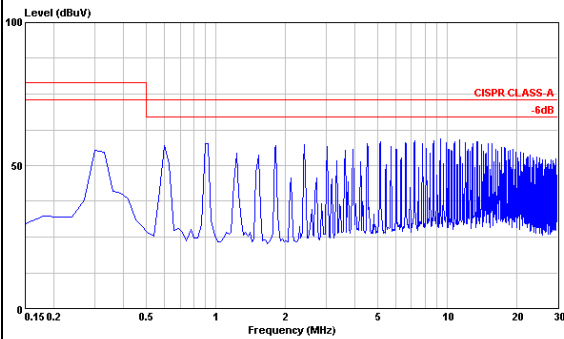

Conduction Emission of EN55022 Class A  
 $V_{in} = V_{in}(nom)$  ; Full Load

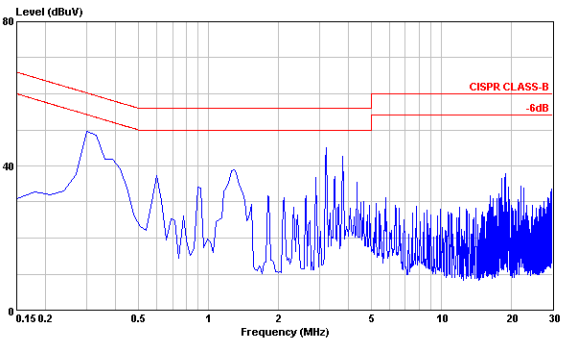

Conduction Emission of EN55022 Class B  
 $V_{in} = V_{in}(nom)$  ; Full Load



Characteristic Curves (Continued)

All test conditions are at 25°C. The figures are for PXD10-48S12

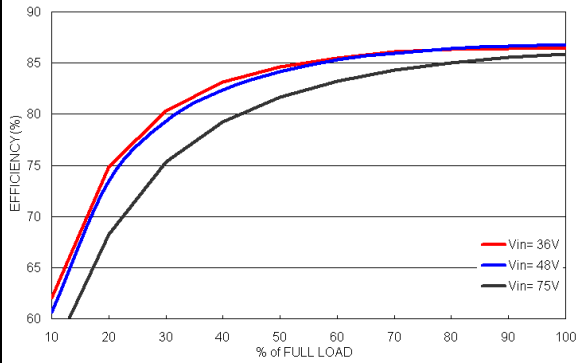

Efficiency versus Output Current

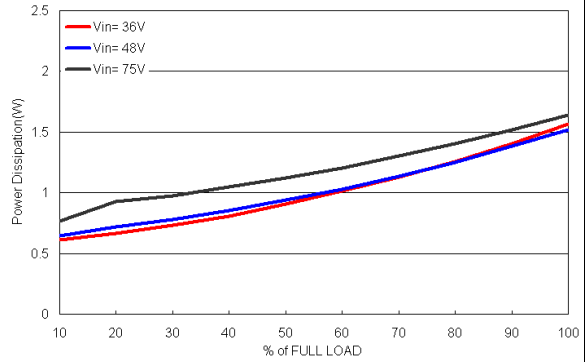

Power Dissipation versus Output Current

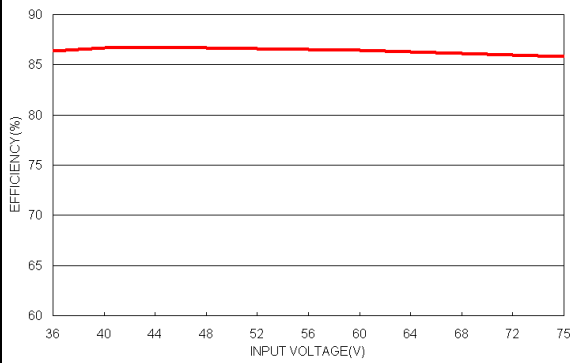

Efficiency versus Input Voltage. Full Load

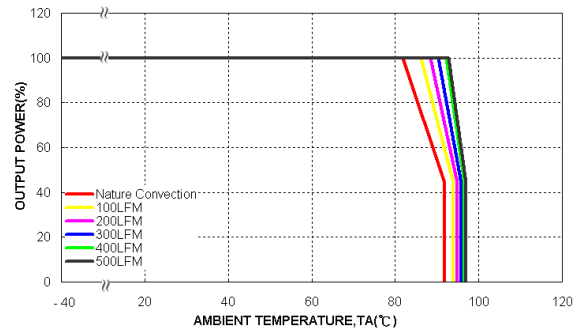

Derating Output Current versus Ambient Temperature and Airflow  
Vin = Vin(nom)

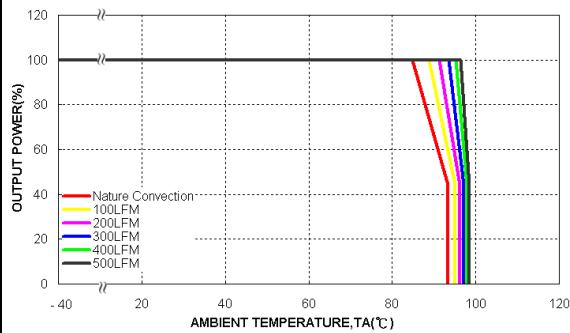

Derating Output Current Versus Ambient Temperature with Heat-Sink  
and Airflow, Vin = Vin(nom)

Characteristic Curves (Continued)

All test conditions are at 25°C. The figures are for PXD10-48S12

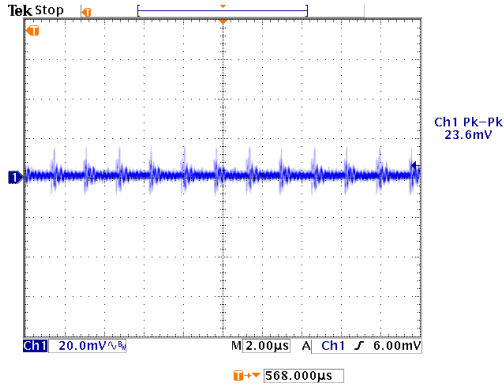

Typical Output Ripple and Noise.  
Vin = Vin(nom) ; Full Load

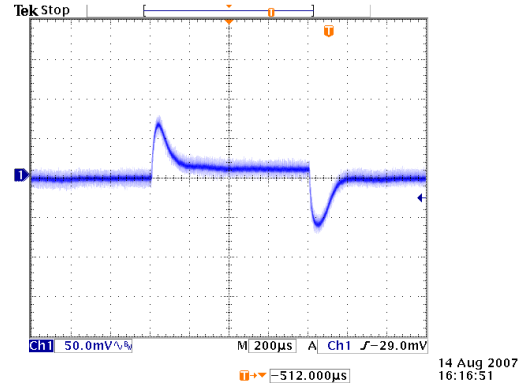

Transient Response to Dynamic Load Change from  
100% to 75% to 100% of Full Load ; Vin = Vin(nom)

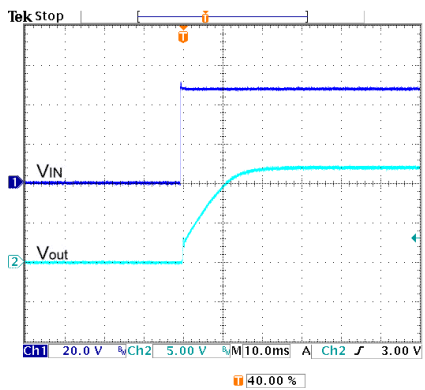

Typical Input Start-up and Output Rise Characteristic  
Vin = Vin(nom) ; Full Load

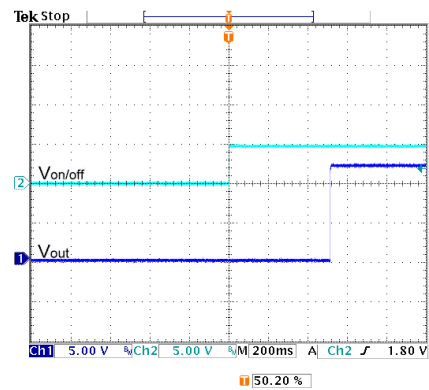

Using ON/OFF Voltage Start-up and Vo Rise Characteristic  
Vin = Vin(nom) ; Full Load

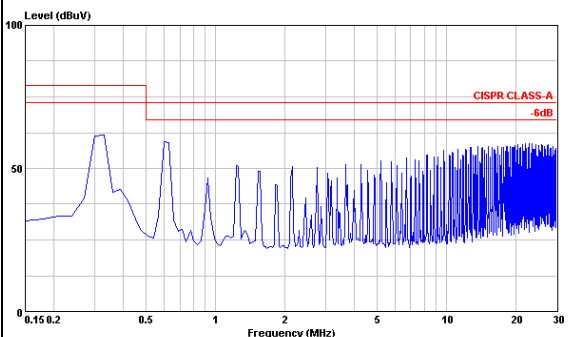

Conduction Emission of EN55022 Class A  
Vin = Vin(nom) ; Full Load

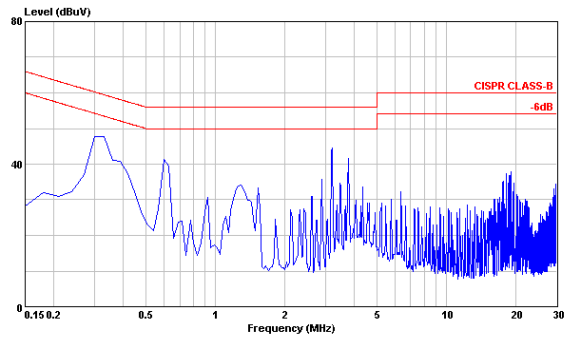

Conduction Emission of EN55022 Class B  
Vin = Vin(nom) ; Full Load

Characteristic Curves (Continued)

All test conditions are at 25°C. The figures are for PXD10-48S15

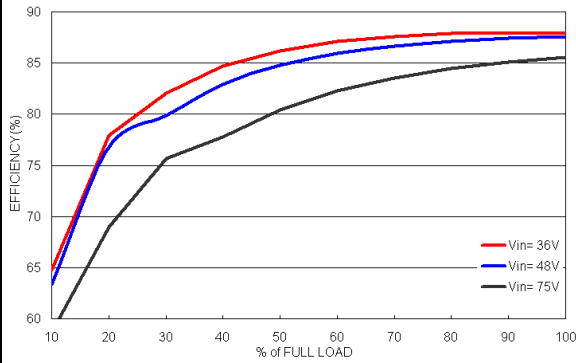

Efficiency versus Output Current

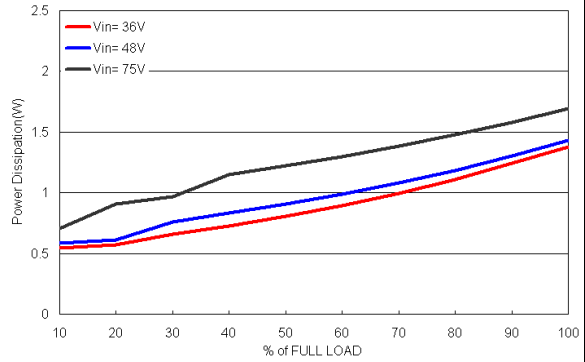

Power Dissipation versus Output Current

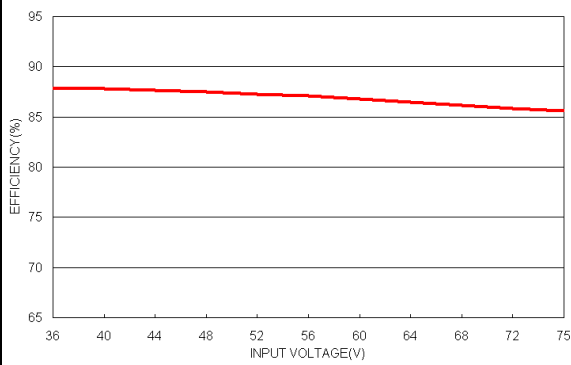

Efficiency versus Input Voltage. Full Load

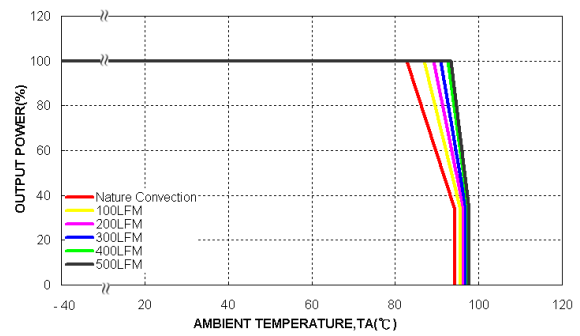

Derating Output Current versus Ambient Temperature and Airflow  
Vin = Vin(nom)

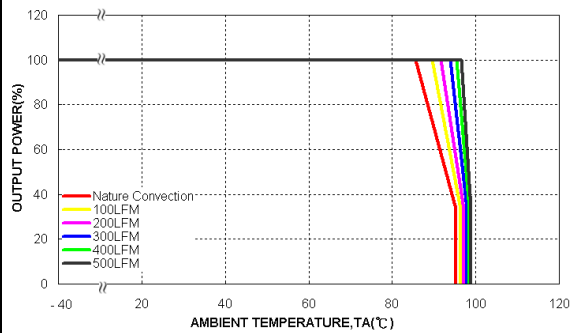

Derating Output Current Versus Ambient Temperature with Heat-Sink  
and Airflow, Vin = Vin(nom)

Characteristic Curves (Continued)

All test conditions are at 25°C. The figures are for PXD10-48S15

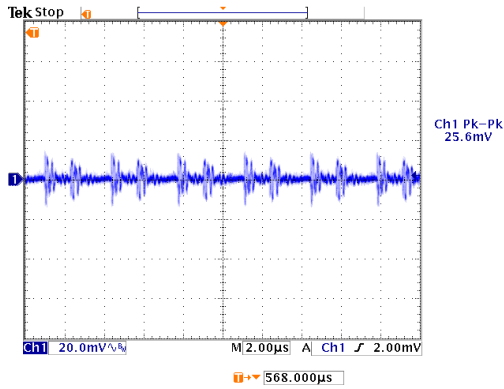

Typical Output Ripple and Noise.  
Vin = Vin(nom) ; Full Load

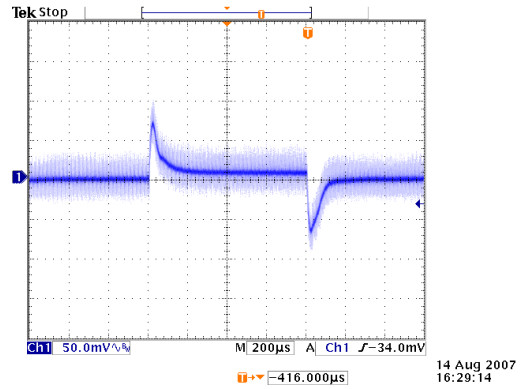

Transient Response to Dynamic Load Change from  
100% to 75% to 100% of Full Load ; Vin = Vin(nom)

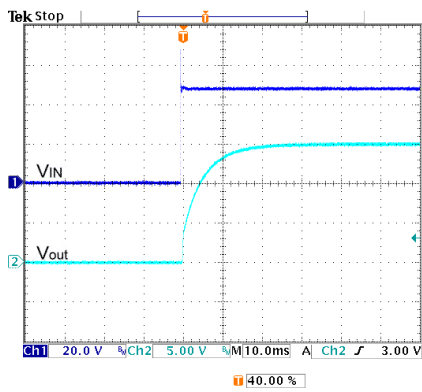

Typical Input Start-up and Output Rise Characteristic  
Vin = Vin(nom) ; Full Load

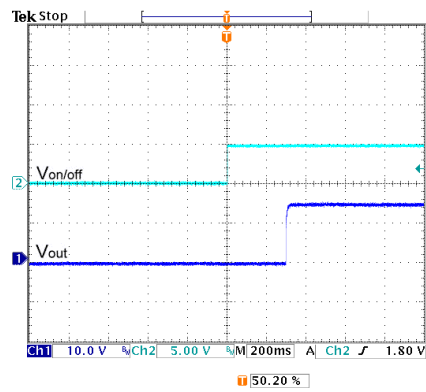

Using ON/OFF Voltage Start-up and Vo Rise Characteristic  
Vin = Vin(nom) ; Full Load

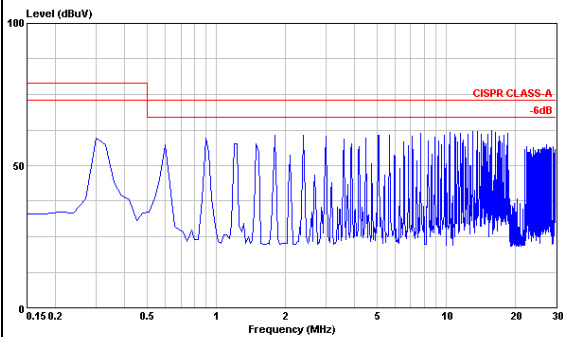

Conduction Emission of EN55022 Class A  
Vin = Vin(nom) ; Full Load

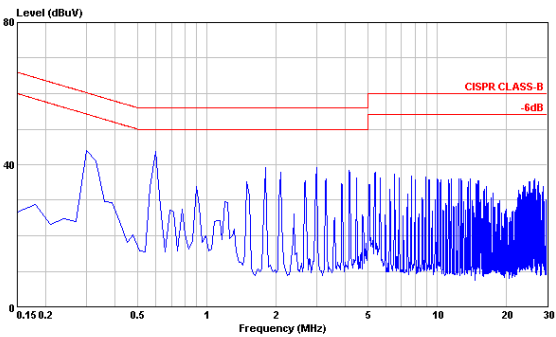

Conduction Emission of EN55022 Class B  
Vin = Vin(nom) ; Full Load

**Test Configurations**

**Input reflected-ripple current measurement test:**

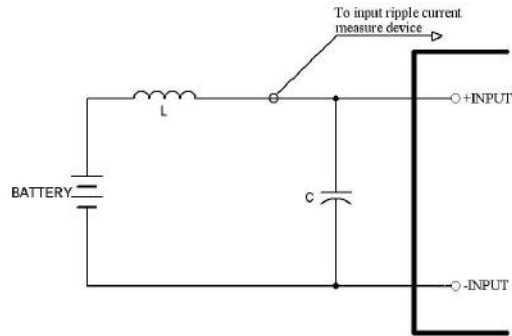

Component	Value	Voltage	Reference
L	12μH	----	----
C	100μF	100V	Aluminum Electrolytic Capacitor

**Peak-to-peak output ripple & noise measurement test:**

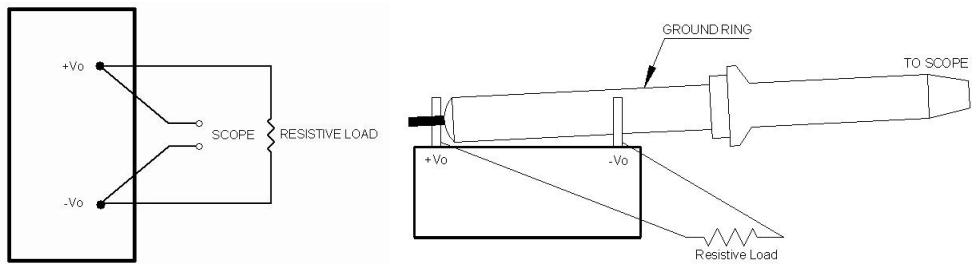

**Output voltage and efficiency measurement test:**

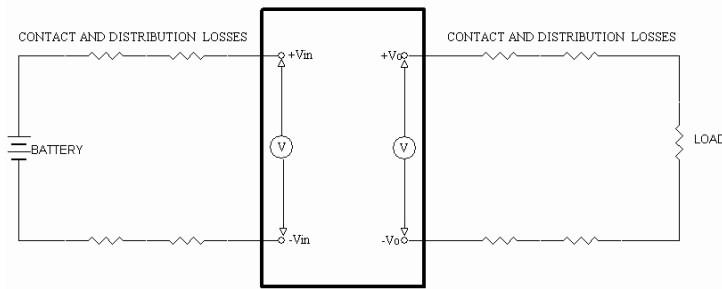

Note: All measurements are taken at the module terminals.

$$Efficiency = \left( \frac{V_o \times I_o}{V_{in} \times I_{in}} \right) \times 100\%$$

EMC considerations

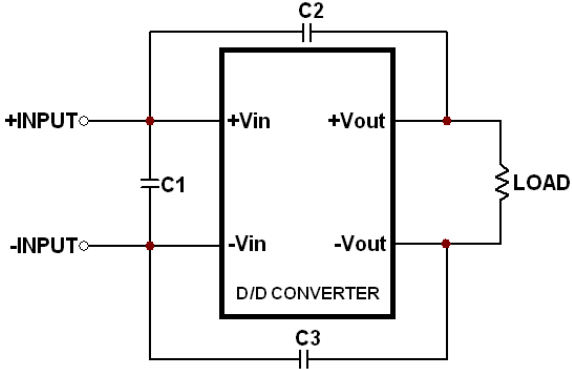

Suggested schematic for EN55022 conducted emissions Class A limits

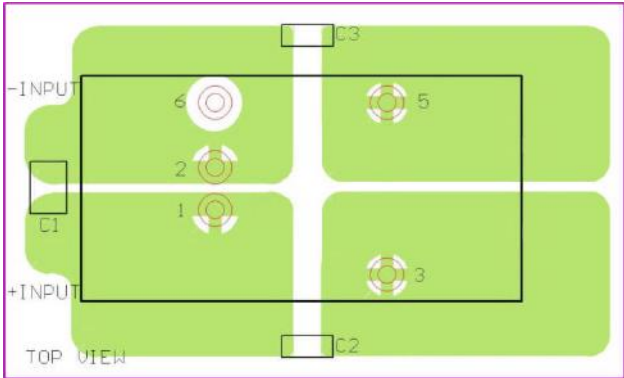

Recommended layout with input filter

To meet conducted emissions EN55022 CLASS A the following components are needed:

PXD10-12Sxx

Component	Value	Voltage	Reference
C1	2.2μF	25V	1206 MLCC
C2,C3	1000pF	2KV	1808 MLCC

PXD10-24Sxx

Component	Value	Voltage	Reference
C1	—	—	—
C2,C3	1000pF	2KV	1808 MLCC

PXD10-48Sxx

Component	Value	Voltage	Reference
C1	—	—	—
C2,C3	1000pF	2KV	1808 MLCC

EMC considerations (Continued)

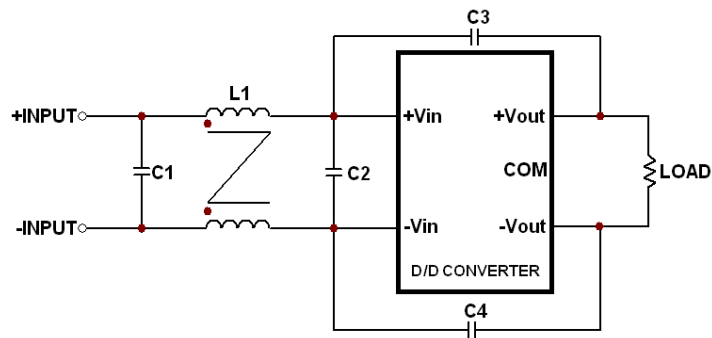

Suggested schematic for EN55022 conducted emissions Class B limits

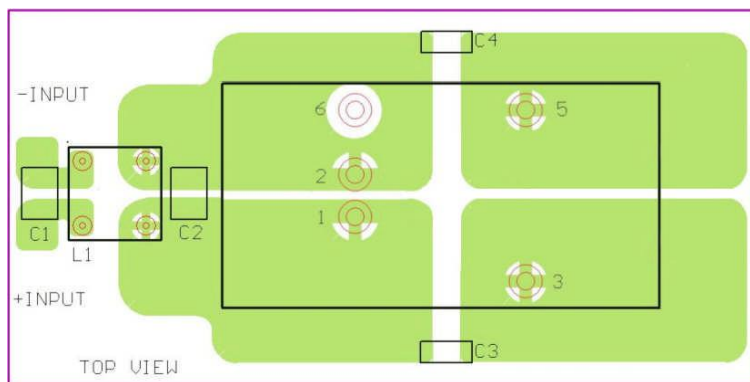

Recommended layout with input filter

To meet conducted emissions EN55022 CLASS B the following components are needed:

PXD10-12Sxx

Component	Value	Voltage	Reference
C1	3.3 $\mu$ F	50V	1812 MLCC
C3,C4	1000pF	2KV	1808 MLCC
L1	325 $\mu$ H	----	Common Choke

PXD10-24Sxx

Component	Value	Voltage	Reference
C1	2.2 $\mu$ F	50V	1812 MLCC
C3,C4	1000pF	2KV	1808 MLCC
L1	325 $\mu$ H	----	Common Choke

PXD10-48Sxx

Component	Value	Voltage	Reference
C1,C2	2.2 $\mu$ F	100V	1812 MLCC
C3,C4	1000pF	2KV	1808 MLCC
L1	325 $\mu$ H	----	Common Choke

This Common Choke L1 has been define as follows:

- L-325 $\mu$ H $\pm$ 35% / DCR-35m $\Omega$ , max
- A height-8.8 mm, Max
- Test condition-100KHz / 100mV
- Recommended through hole- $\Phi$ 0.8mm
- All dimensions in millimeters

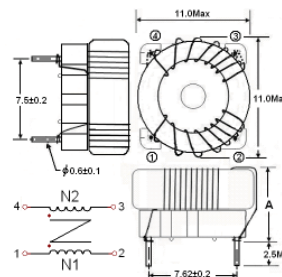

### Input Source Impedance

The power module should be connected to a low impedance input source. Highly inductive source impedance can affect the stability of the power module. Input external L-C filter is recommended to minimize input reflected ripple current. The inductor is a simulated source impedance of 12 $\mu$ H and the capacitor is Nippon chemi-con KY series 100 $\mu$ F/100V. The capacitor must be as close as possible to the input terminals of the power module for lowest impedance.

### Output Over Current Protection

When excessive output currents occur in the system, circuit protection is required on all power supplies. Normally, overload current is maintained at approximately 130 percent of rated current for the PXD10-xxSxx series.

Hiccup-mode is a method of operation in a power supply whose purpose is to protect the power supply from being damaged during an over-current fault condition. It also enables the power supply to restart when the fault is removed. There are other ways of protecting the power supply when it is over-loaded, such as the maximum current limiting or current fold-back method.

One of the problems resulting from over current is that excessive heat may be generated in power devices; especially MOSFET and Schottky diodes and the temperature of these devices may exceed their specified limits. A protection mechanism has to be used to prevent these power devices from being damaged.

The operation of hiccup is as follows. When the current sense circuit sees an over-current event, the controller shuts off the power supply for a given time and then tries to restart the power supply. If the over-load condition has been removed, the power supply will start and operate normally; otherwise, the controller will see another over-current event and shut off the power supply, repeating the previous cycle. Hiccup operation has none of the drawbacks of the other two protection methods, although its circuit is more complicated because it requires a timing circuit. The excess heat due to overload lasts for only a short duration in the hiccup cycle, hence the junction temperature of the power devices is much lower.

The hiccup operation can be done in various ways. For example, one can start hiccup operation any time an over-current event is detected or prohibit hiccup during a designated start-up interval (usually a few milliseconds). The reason for the latter operation is that during start-up, the power supply needs to provide extra current to charge up the output capacitor. Thus the current demand during start-up is usually larger than during normal operation and it is easier for an over-current event to occur. If the power supply starts to hiccup once there is an over-current, it might never start up successfully. Hiccup mode protection will give the best protection for a power supply against over current situations, since it will limit the average current to the load at a low level, thus reducing power dissipation and case temperature in the power devices.

### Output Over Voltage Protection

The output over-voltage protection consists of output Zener diode that monitors the voltage on the output terminals. If the voltage on the output terminals exceeds the over-voltage protection threshold, then the Zener diode clamps the output voltage.

### Short Circuit Protection

Continuous, hiccup and auto-recovery mode.



### Thermal Consideration

The power module operates in a variety of thermal environments; however, sufficient cooling should be provided to help ensure reliable operation of the unit. Heat is removed by conduction, convection, and radiation to the surrounding environment. Proper cooling can be verified by measuring the point as shown in the figure below. The temperature at this location should not exceed 100°C. When operating, adequate cooling must be provided to maintain the test point temperature at or below 100°C. Although the maximum temperature of the power module is 100°C, lowering this temperature yields higher reliability.

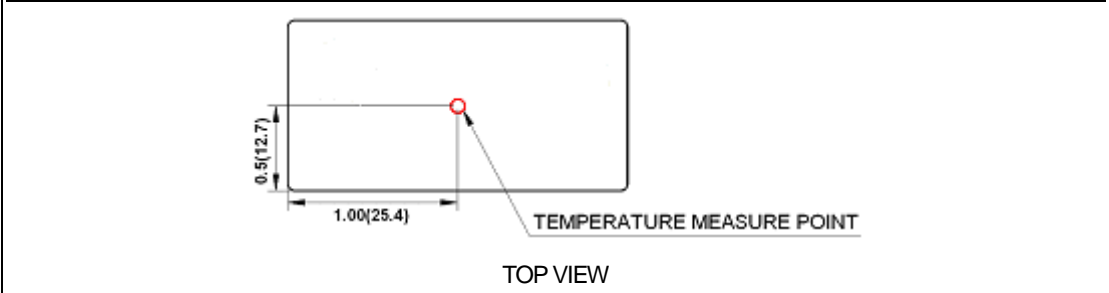

**Remote ON/OFF Control (Option)**

Remote control is an optional feature.

Positive logic:

Turns the module On during logic High on the On/Off pin and turns Off during logic Low.

Negative logic:

Turns the module On during logic Low on the On/Off pin and turns Off during logic High.

The On/Off pin is an open collector/drain logic input signal ( $V_{on/off}$ ) that referenced to  $-V_{IN}$ .

Remote On/Off Implementation

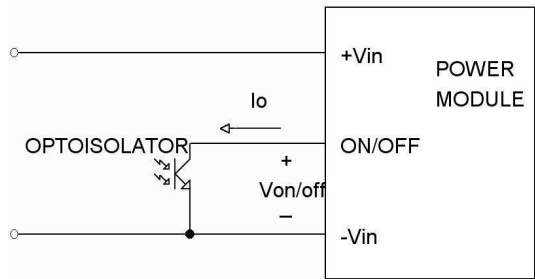

Isolated-Closure Remote On/Off

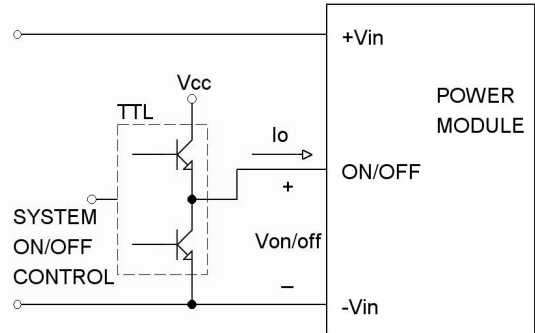

Level Control Using TTL Output

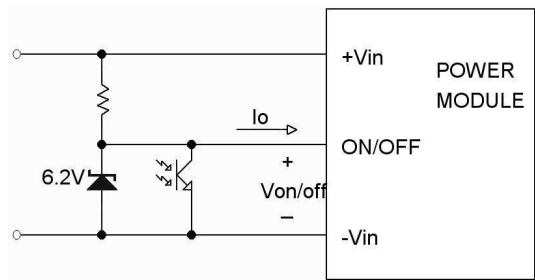

Level Control Using Line Voltage

**Heat Sink**

Use heat-sink (7G-0020A) for lowering temperature and increased reliability of the module.

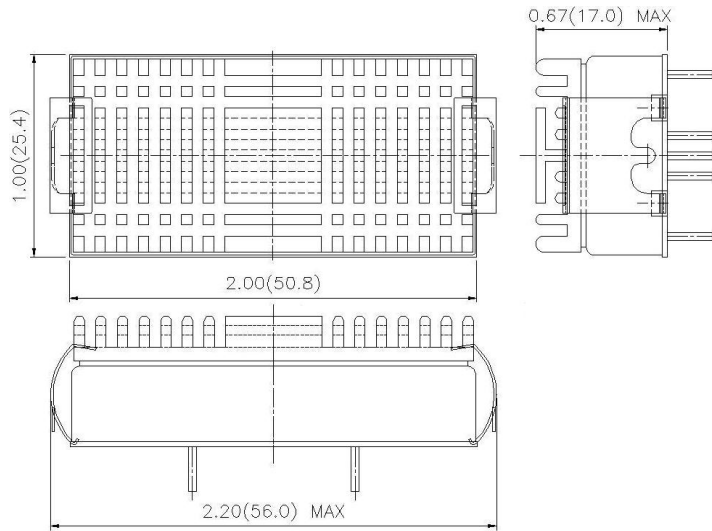

All dimensions in Inches (mm)

**Mechanical Data**

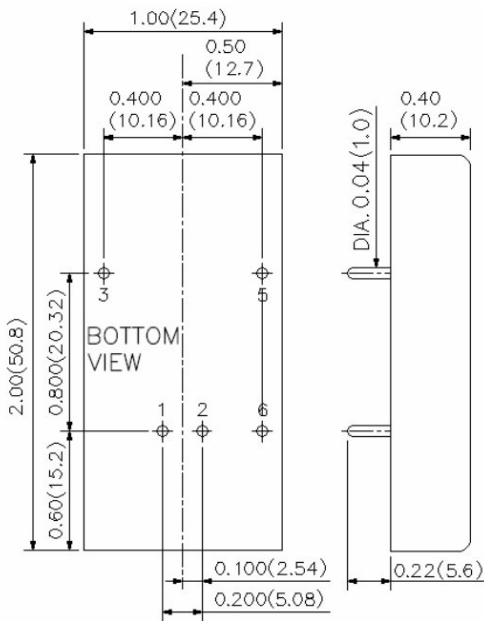

PIN CONNECTION	
Pin	Function
1	+ INPUT
2	- INPUT
3	+ OUTPUT
5	- OUTPUT
6	CTRL (Option)

1. All dimensions in Inches (mm)  
Tolerance-x.xx±0.02 (x.xx±0.5)  
x.xxx±0.01 (x.xx±0.25)
2. Pin pitch tolerance ±0.01(0.25)
3. Pin dimension tolerance ±0.014(0.35)

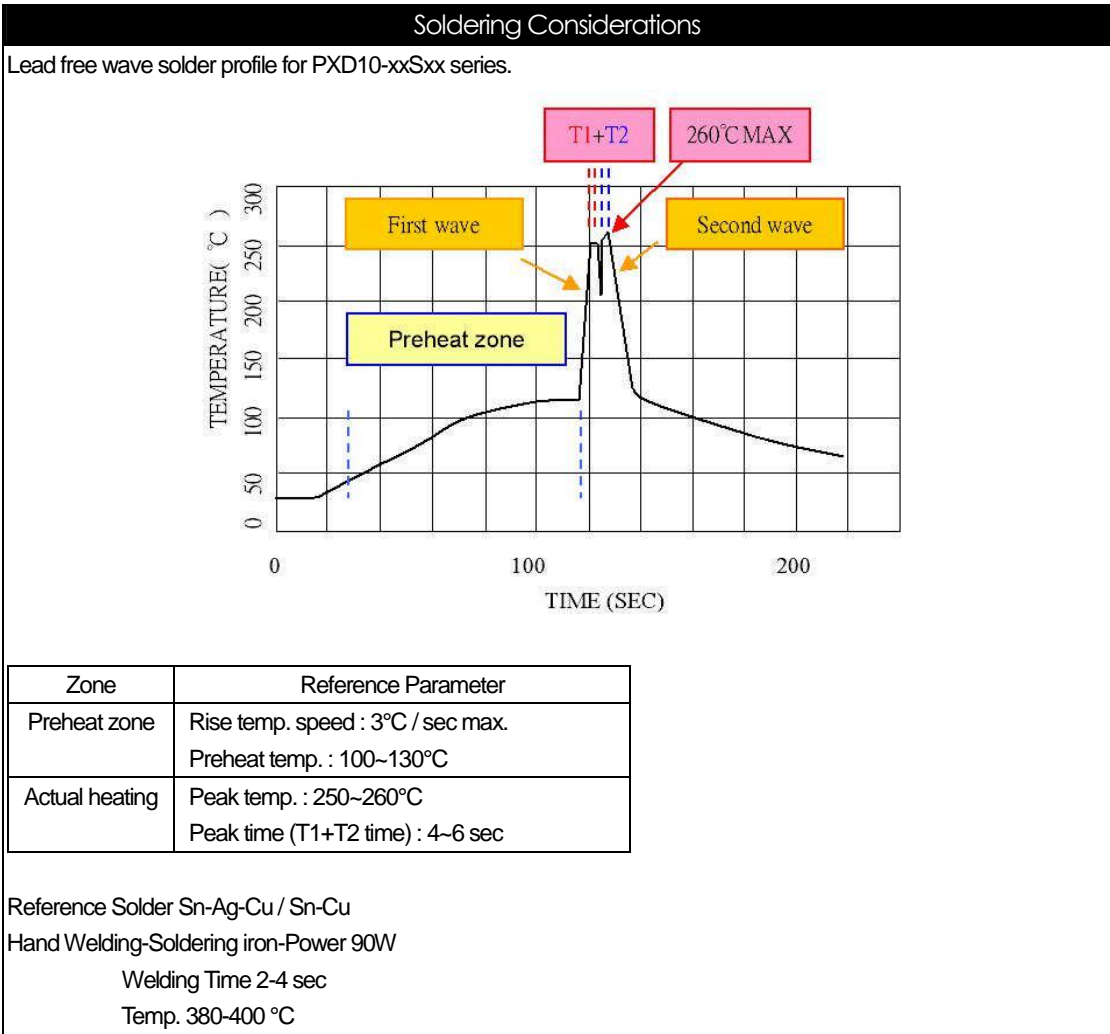
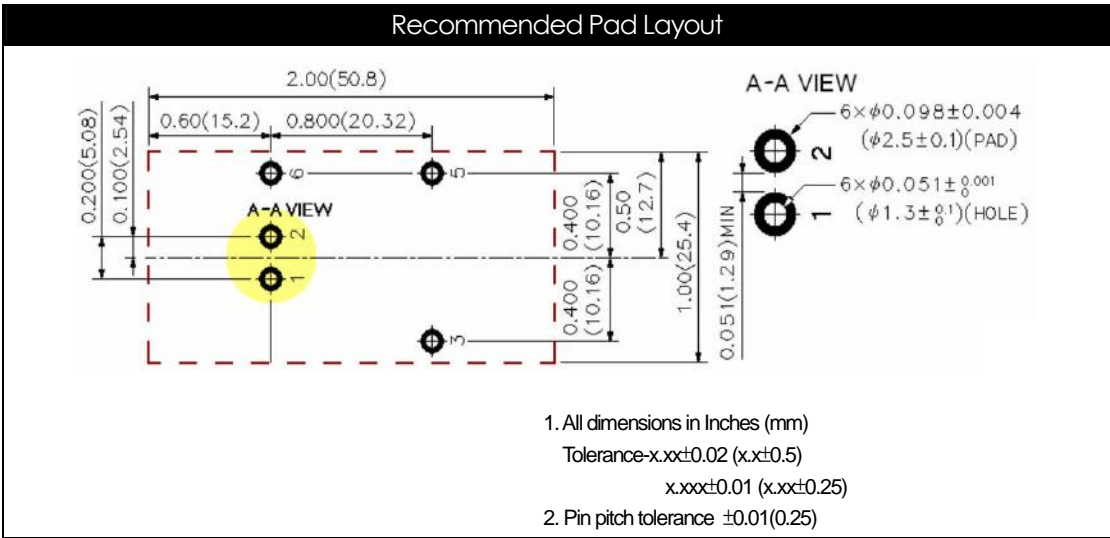

Packaging Information

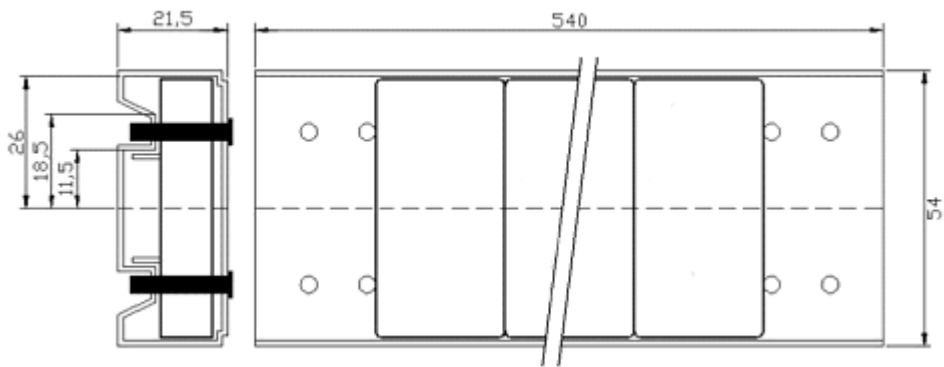

Dimensions in mm

20 Pieces per Tube

Part Number Structure

PXD 10 - 48 S 05 - P

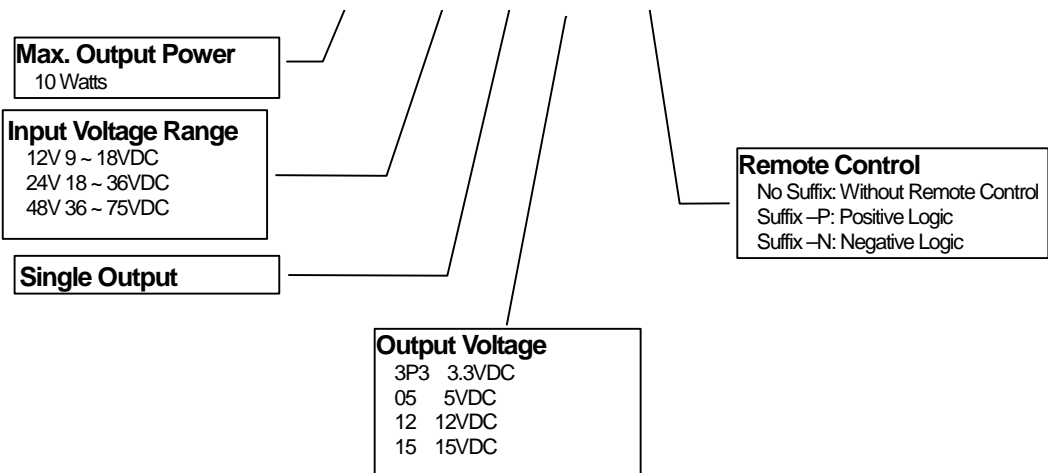

Model Number	Input Range	Output Voltage	Output Current Max. Load	Input Current Full Load <sup>(1)</sup>	Eff <sup>(2)</sup> (%)
PXD10-12S3P3	9 – 18 VDC	3.3VDC	2000mA	724mA	80
PXD10-12S05	9 – 18 VDC	5VDC	2000mA	1082mA	81
PXD10-12S12	9 – 18 VDC	12VDC	830mA	1037mA	84
PXD10-12S15	9 – 18 VDC	15VDC	670mA	1046mA	84
PXD10-24S3P3	18 – 36 VDC	3.3VDC	2000mA	362mA	80
PXD10-24S05	18 – 36 VDC	5VDC	2000mA	534mA	82
PXD10-24S12	18 – 36 VDC	12VDC	830mA	519mA	84
PXD10-24S15	18 – 36 VDC	15VDC	670mA	523mA	84
PXD10-48S3P3	36 – 75 VDC	3.3VDC	2000mA	181mA	80
PXD10-48S05	36 – 75 VDC	5VDC	2000mA	260mA	84
PXD10-48S12	36 – 75 VDC	12VDC	830mA	253mA	86
PXD10-48S15	36 – 75 VDC	15VDC	670mA	252mA	87

Note 1. Maximum value at nominal input voltage and full load of standard type.  
 Note 2. Typical value at nominal input voltage and full load.

### Safety and Installation Instruction

#### Fusing Consideration

Caution: This power module is not internally fused. An input line fuse must always be used.

This encapsulated power module can be used in a wide variety of applications, ranging from simple stand-alone operation to an integrated part of a sophisticated power architecture. For maximum flexibility, internal fusing is not included; however, to achieve maximum safety and system protection, always use an input line fuse. The safety agencies require a slow-blow fuse with maximum rating of 5A. Based on the information provided in this data sheet on Inrush energy and maximum dc input current; the same type of fuse with lower rating can be used. Refer to the fuse manufacturer's data for further information.

### MTBF and Reliability

#### The MTBF of PXD10-xxSxx series of DC/DC converters has been calculated using

Belcore TR-NWT-000332 Case I: 50% stress, Operating Temperature at 40 °C (Ground fixed and controlled environment ). The resulting figure for MTBF is  $1.976 \times 10^6$  hours.

MIL-HDBK 217F NOTICE2 FULL LOAD, Operating Temperature at 25°C °C. The resulting figure for MTBF is  $1.416 \times 10^6$  hours.