

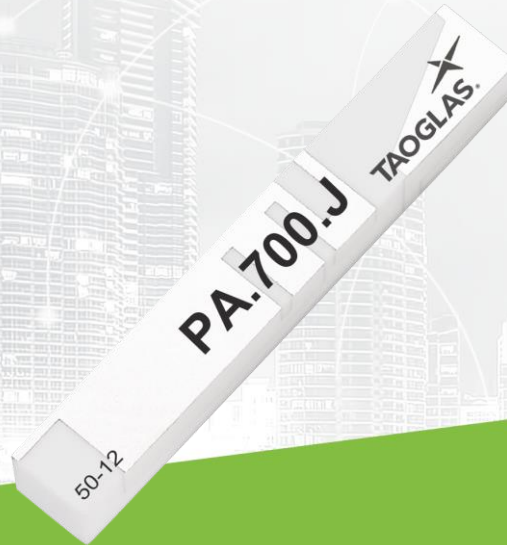

TAOGLAS®



Datasheet

Part No:
PA.700.J

Description:
Samurai Hexa-Band Cellular SMD Antenna

Features:
Designed for Japan LTE frequency bands
Covers all in one 4G/3G/2G applications
700~2700MHz
High efficiency wide-band antenna
Patent pending
SMT for precision mounting and labor saving
40*6*5mm
RoHS✓

1. Introduction	3
2. Specifications	5
3. Test Setup	8
4. Antenna Characteristics	9
5. Mechanical Drawing	16
6. EVB Dimensions	18
7. Antenna Intergration Guide	20
8. Packaging	27
9. Solder Reflow Profile	28
<hr/>	
Changelog	29

Taoglas makes no warranties based on the accuracy or completeness of the contents of this document and reserves the right to make changes to specifications and product descriptions at any time without notice. Taoglas reserves all rights to this document and the information contained herein. Reproduction, use or disclosure to third parties without express permission is strictly prohibited.



1. Introduction



This revolutionary patent pending Samurai PA.700.J is a 4G/3G/2G high efficiency SMD ceramic antenna operating at 700MHz to 960MHz, 1400MHz to 2600MHz to cover all LTE frequency bands applied in Japan. It uses high grade ceramics to deliver the highest efficiencies on all bands on the shortest device ground-plane lengths possible. The exceptional wide-band response means it covers all standardly used operation bands around the globe.

Key Advantages

1. **Highest efficiency in small size 40mm*6mm*5mm.** A comparative metal, FR4, FPC, whip, rod, helix antenna, would have much more reduced efficiency in this configuration for the same size due to their different dielectric constants. Very high efficiency antennas are critical to 3G and 4G devices ability to deliver the stated data-speed rates of systems such as HSPA and LTE.
2. **More resistant to detuning compared to other antenna integrations.** If tuning is required it can be tuned for the device environment using a matching circuit or other techniques. There is no need for new tooling, thereby saving money if customization is required.
3. **Highly reliable and robust**– its predecessor the PA.25 antenna is used by the world’s leading auto makers in extremely challenging environments. The antenna meets all temperature and mechanical specs required (vibration, drop tests etc.)
4. **Rectangular shape - Easy to integrate.** Other antenna designs come in irregular shapes and sizes making them hard to integrate.
5. **SMD (On-Board) antenna** saves on labor, cable and connector costs, leads to higher integration yield rates, and reduces losses in transmission.
6. **It mounts directly** on edge of device main-board.
7. **Transmission losses are kept to absolute minimum** resulting in much improved over the air (OTA) TRP (Total Radiated Power) / TIS (Total Isotropic Radiation) device performance compared to similar efficiency cable and connector antenna solutions.
8. **Reductions in probability of radiated spurious emissions** compared to other antenna technologies are observed when using the PA.700.J and strictly following this application note layout
9. **Achieves moderate to high gain in both vertical and horizontal polarization planes.** This feature is very useful in certain wireless communications where the antenna orientation is not fixed and the reflections or multipath signals may be present from any plane. In those cases the important parameter to be considered is the total field strength, which is the vector sum of the signal from the horizontal and vertical polarization planes at any instant in time.

LTE Bands (Japan)		Frequency
1	2100	1920~2170MHz
6	800	830~885MHz
8	900	880~960MHz
9	1700	1749~1880MHz
11	1500	1427~1496MHz
18	800	815~875MHz
19	800	832~889MHz
21	1500	1447~1510MHz
41	2500	2496~2690MHz

2. Specifications

Electrical					
Antenna	PA.700.J				
Standard	4G/3G/2G				
Operation Frequency (MHz)	698~800	824~960	1410~1520	1710~2170	2400~2700
Peak Gain	-3.6dBi	-0.5dBi	-1.0dBi	0.5dBi	2.7dBi
Average Gain	-5.5dB	-2.0dB	-2.5dB	-2.8dB	-2.4
Efficiency	30%	63%	55%	53%	57%
Return Loss [dB]	-5.0dB	-14.0dB	-7.0dB	-7.0dB	-7.5dB
VSWR	<3.5:1				
Impedance	50Ω				
Polarization	Linear				
Radiation Properties	Omni-directional				
Max Input Power	5 W				

* The PA.700.J antenna performance was measured with 106.5x44 mm ground plane.

Mechanical	
Dimensions (mm)	40 x 5 x 5 mm
Material	Ceramic
Termination	Ag (environmental-friendly Pb free)
EVB Connector	SMA-Female
Environmental	
Operation Temperature	-40°C to 85°C
Storage Temperature	-40°C to 105°C
Moisture Sensitivity	Level 3
RoHS Compliant	Yes

* All electrical properties are measured with PA.700.J mounted on its EVB with 106.5x44mm ground.

2.1 LTE Bands – On 50*50mm Ground Plane

LTE Bands			
Band Number	LTE / LTE-Advanced / WCDMA / HSPA / HSPA+ / TD-SCDMA		
	Uplink	Downlink	Covered
1	UL: 1920 to 1980	DL: 2110 to 2170	✓
2	UL: 1850 to 1910	DL: 1930 to 1990	✓
3	UL: 1710 to 1785	DL: 1805 to 1880	✓
4	UL: 1710 to 1755	DL: 2110 to 2155	✓
5	UL: 824 to 849	DL: 869 to 894	✗
7	UL: 2500 to 2570	DL: 2620 to 2690	✓
8	UL: 880 to 915	DL: 925 to 960	✗
9	UL: 1749.9 to 1784.9	DL: 1844.9 to 1879.9	✓
11	UL: 1427.9 to 1447.9	DL: 1475.9 to 1495.9	✓
12	UL: 699 to 716	DL: 729 to 746	✗
13	UL: 777 to 787	DL: 746 to 756	✗
14	UL: 788 to 798	DL: 758 to 768	✗
17	UL: 704 to 716	DL: 734 to 746 (LTE only)	✗
18	UL: 815 to 830	DL: 860 to 875 (LTE only)	✗
19	UL: 830 to 845	DL: 875 to 890	✗
20	UL: 832 to 862	DL: 791 to 821	✗
21	UL: 1447.9 to 1462.9	DL: 1495.9 to 1510.9	✓
22	UL: 3410 to 3490	DL: 3510 to 3590	✗
23	UL: 2000 to 2020	DL: 2180 to 2200 (LTE only)	✓
24	UL: 1625.5 to 1660.5	DL: 1525 to 1559 (LTE only)	✓
25	UL: 1850 to 1915	DL: 1930 to 1995	✓
26	UL: 814 to 849	DL: 859 to 894	✗
27	UL: 807 to 824	DL: 852 to 869 (LTE only)	✗
28	UL: 703 to 748	DL: 758 to 803 (LTE only)	✗
29	UL: -	DL: 717 to 728 (LTE only)	✗
30	UL: 2305 to 2315	DL: 2350 to 2360 (LTE only)	✓
31	UL: 452.5 to 457.5	DL: 462.5 to 467.5 (LTE only)	✗
32	UL: -	DL: 1452 - 1496	✓
35		1850 to 1910	✓
38		2570 to 2620	✓
39		1880 to 1920	✓
40		2300 to 2400	✓
41		2496 to 2690	✓
42		3400 to 3600	✗
43		3600 to 3800	✗

*Covered bands represent an efficiency greater than 20%

2.2 LTE Bands – On 100*100mm Ground Plane

LTE Bands			
Band Number	LTE / LTE-Advanced / WCDMA / HSPA / HSPA+ / TD-SCDMA		
	Uplink	Downlink	Covered
1	UL: 1920 to 1980	DL: 2110 to 2170	✓
2	UL: 1850 to 1910	DL: 1930 to 1990	✓
3	UL: 1710 to 1785	DL: 1805 to 1880	✓
4	UL: 1710 to 1755	DL: 2110 to 2155	✓
5	UL: 824 to 849	DL: 869 to 894	✓
7	UL: 2500 to 2570	DL: 2620 to 2690	✓
8	UL: 880 to 915	DL: 925 to 960	✓
9	UL: 1749.9 to 1784.9	DL: 1844.9 to 1879.9	✓
11	UL: 1427.9 to 1447.9	DL: 1475.9 to 1495.9	✓
12	UL: 699 to 716	DL: 729 to 746	✗
13	UL: 777 to 787	DL: 746 to 756	✗
14	UL: 788 to 798	DL: 758 to 768	✓
17	UL: 704 to 716	DL: 734 to 746 (LTE only)	✗
18	UL: 815 to 830	DL: 860 to 875 (LTE only)	✓
19	UL: 830 to 845	DL: 875 to 890	✓
20	UL: 832 to 862	DL: 791 to 821	✓
21	UL: 1447.9 to 1462.9	DL: 1495.9 to 1510.9	✓
22	UL: 3410 to 3490	DL: 3510 to 3590	✗
23	UL: 2000 to 2020	DL: 2180 to 2200 (LTE only)	✓
24	UL: 1625.5 to 1660.5	DL: 1525 to 1559 (LTE only)	✓
25	UL: 1850 to 1915	DL: 1930 to 1995	✓
26	UL: 814 to 849	DL: 859 to 894	✓
27	UL: 807 to 824	DL: 852 to 869 (LTE only)	✓
28	UL: 703 to 748	DL: 758 to 803 (LTE only)	✗
29	UL: -	DL: 717 to 728 (LTE only)	✗
30	UL: 2305 to 2315	DL: 2350 to 2360 (LTE only)	✓
31	UL: 452.5 to 457.5	DL: 462.5 to 467.5 (LTE only)	✗
32	UL: -	DL: 1452 - 1496	✓
35		1850 to 1910	✓
38		2570 to 2620	✓
39		1880 to 1920	✓
40		2300 to 2400	✓
41		2496 to 2690	✓
42		3400 to 3600	✗
43		3600 to 3800	✗

*Covered bands represent an efficiency greater than 20%

3. Test Setup

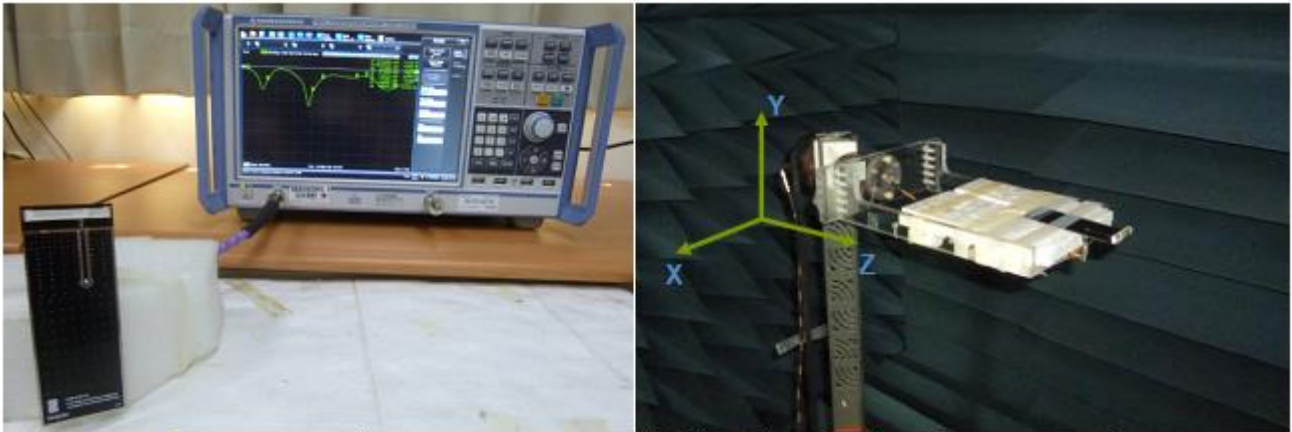

Impedance measurements (left hand) and peak gain, average gain, efficiency and radiation pattern measurements (right hand)

4. Antenna Characteristics

4.1 Return Loss

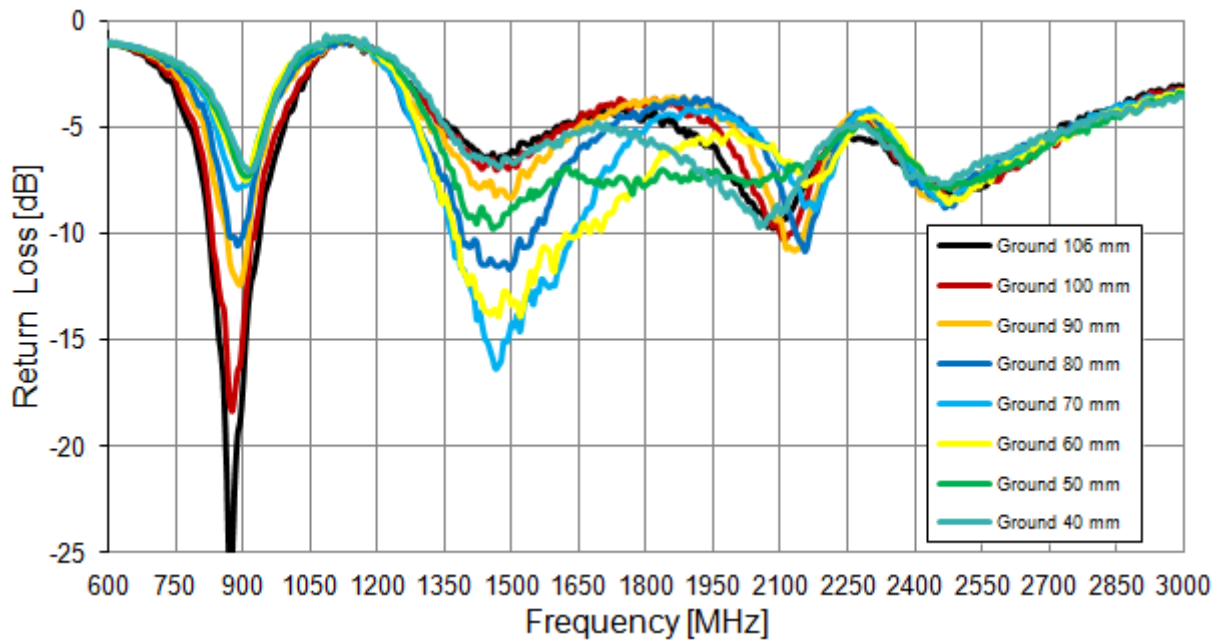

Return Loss of the PA.700.J LTE Antenna.

4.2 VSWR

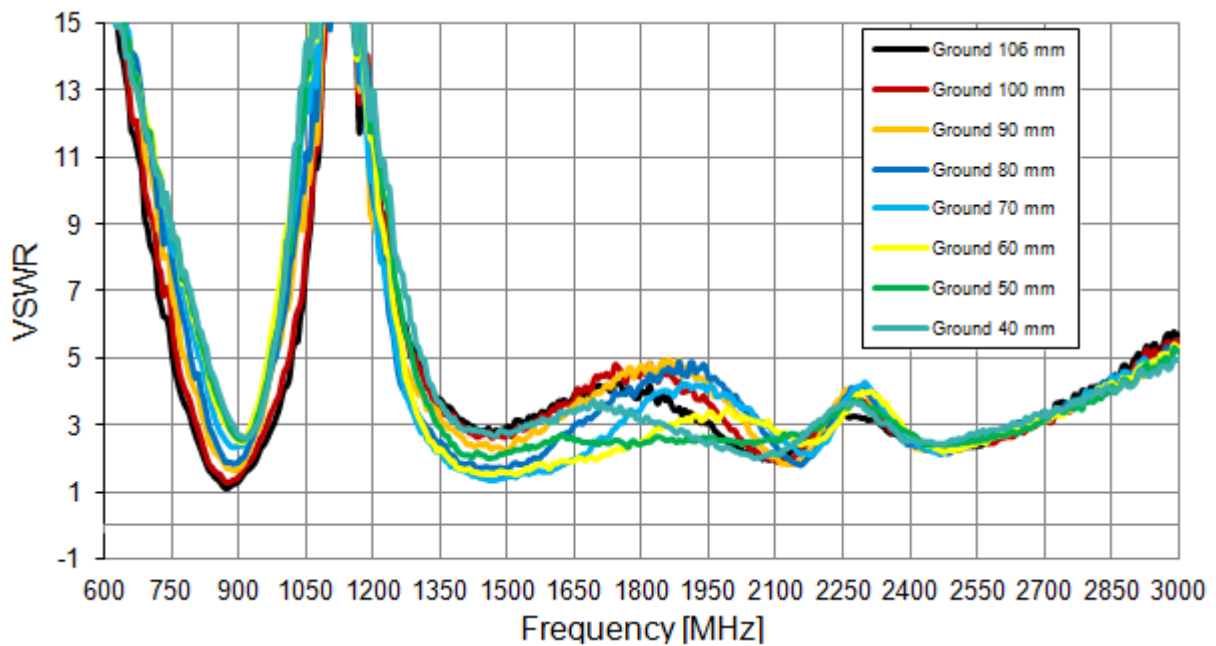

VSWR of the PA.700.J LTE Antenna.

4.3 Efficiency

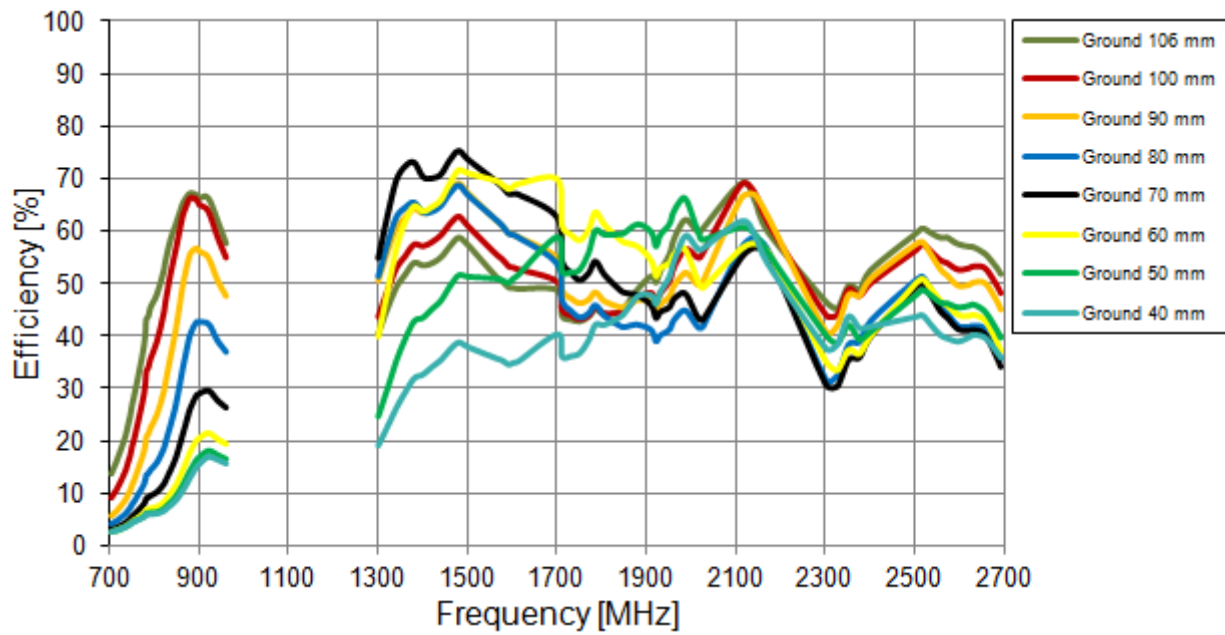

Efficiency of the PA.700.J LTE Antenna.

4.4 Peak Gain

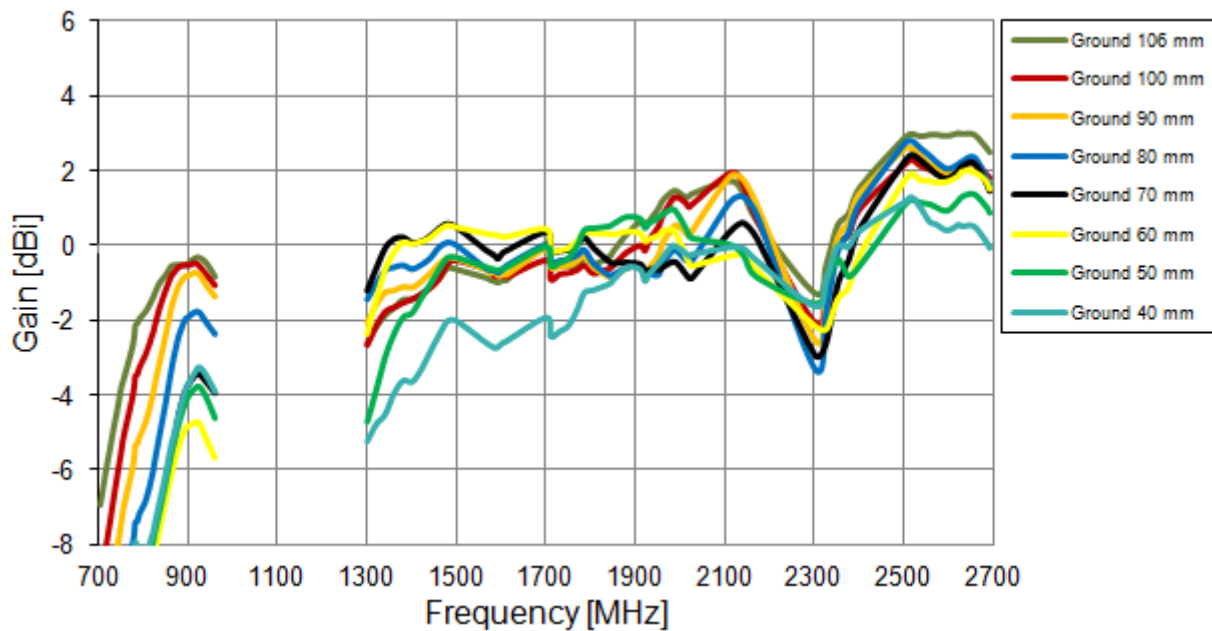

Peak Gain of the PA.700.J LTE Antenna.

4.5 Average Gain

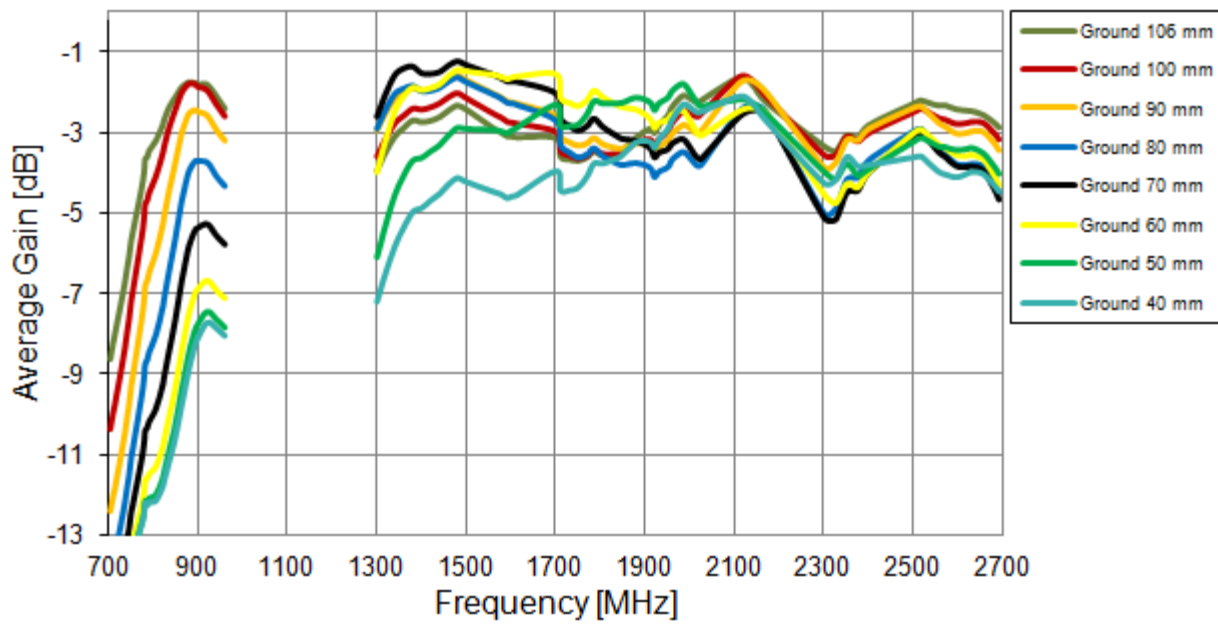

Average Gain of the PA.700.J LTE antenna.

4.6 3D Radiation Pattern

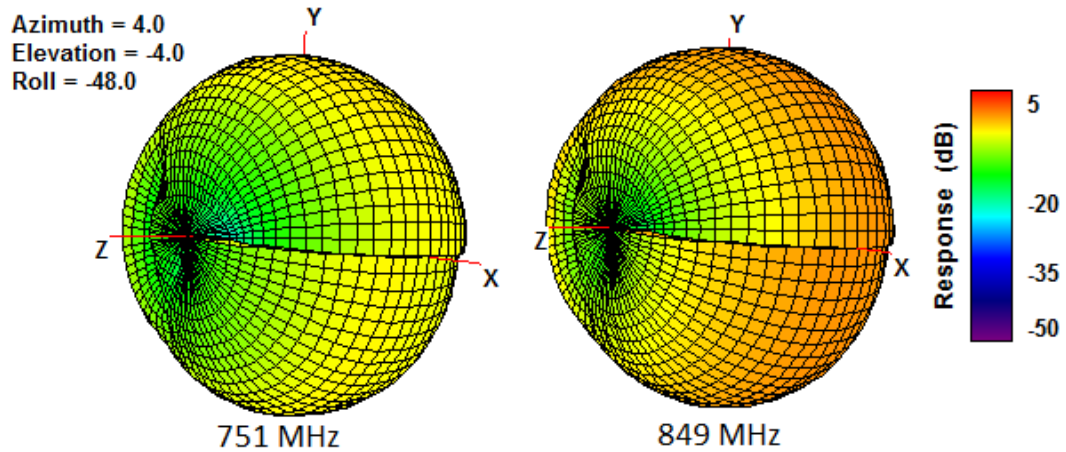

3D Radiation Pattern at 751 MHz and 849 MHz of the PA.700.J Antenna.

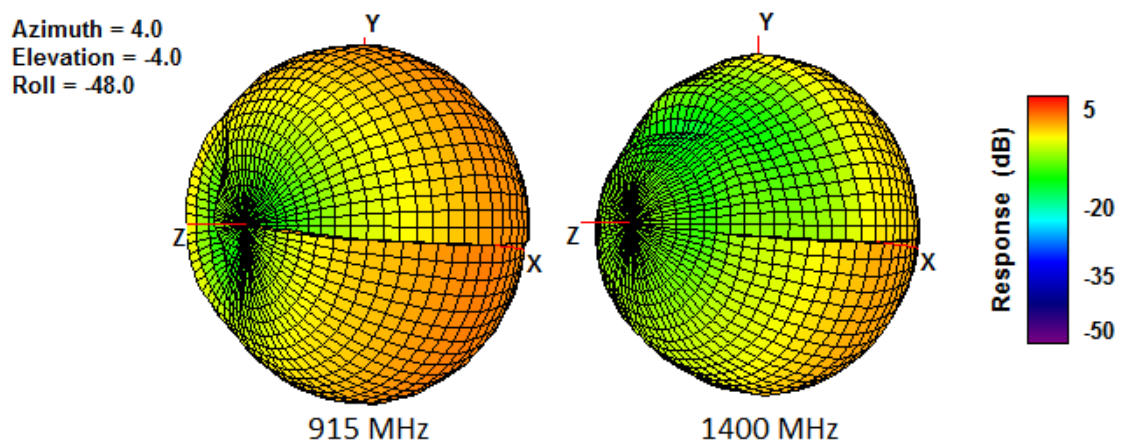

3D Radiation Pattern at 915 MHz and 1400 MHz of the PA.700.J Antenna.

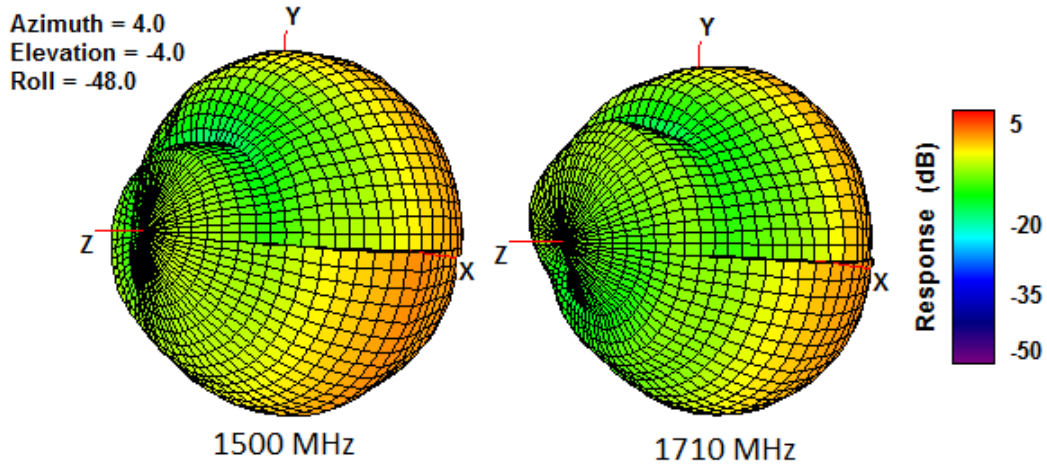

3D Radiation Pattern at 1500 MHz and 1710 MHz of the PA.700.J Antenna.

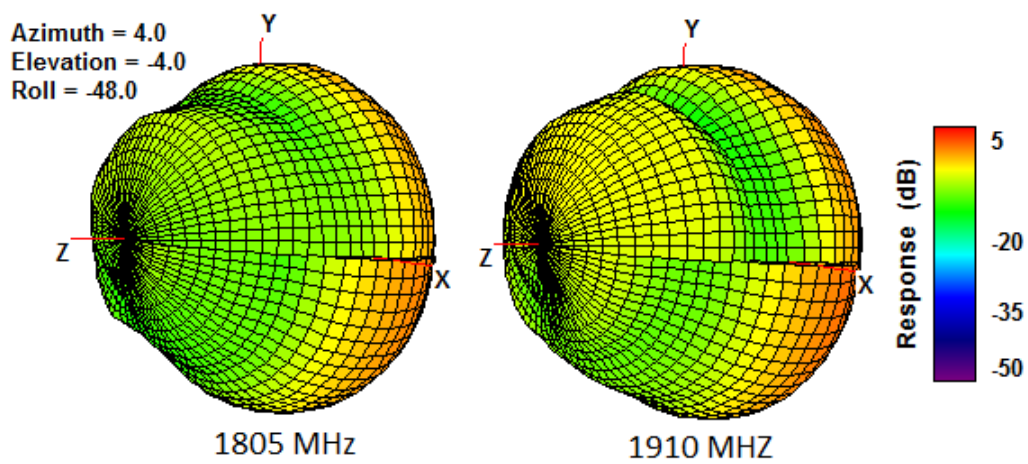

3D Radiation Pattern at 1805 MHz and 1910 MHz of the PA.700.J Antenna.

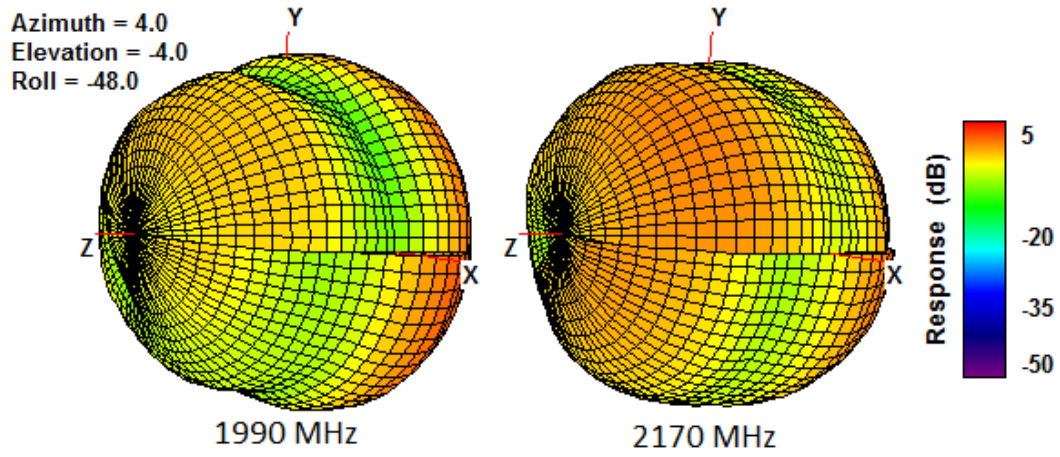

3D Radiation Pattern at 1990 MHz and 2170 MHz of the PA.700.J Antenna.

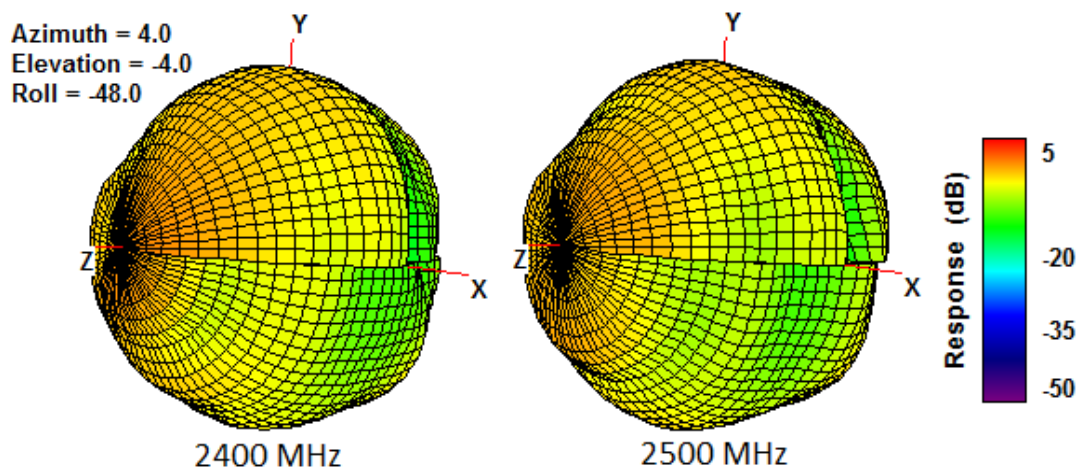

3D Radiation Pattern at 2400 and 2500 MHz of the PA.700.J Antenna.

4.7 2D Radiation Pattern

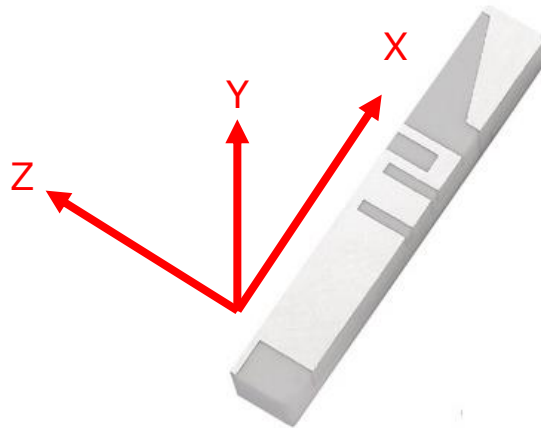

XY Plane

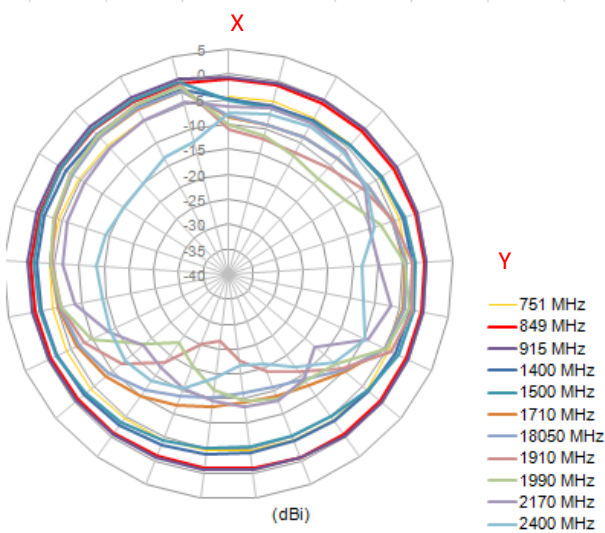

YZ Plane

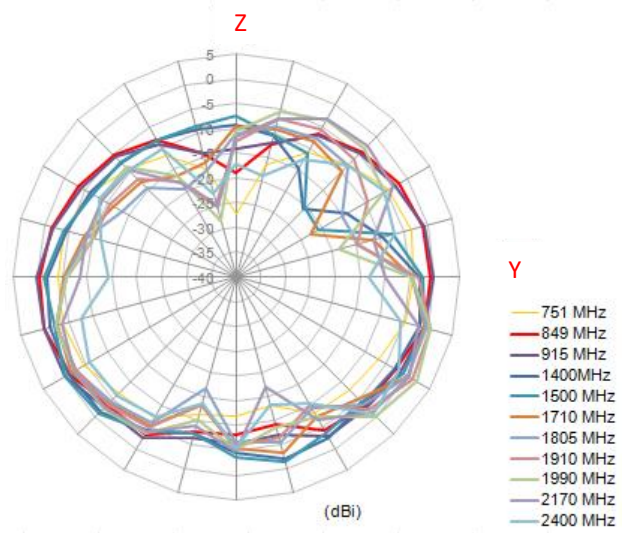

XZ Plane

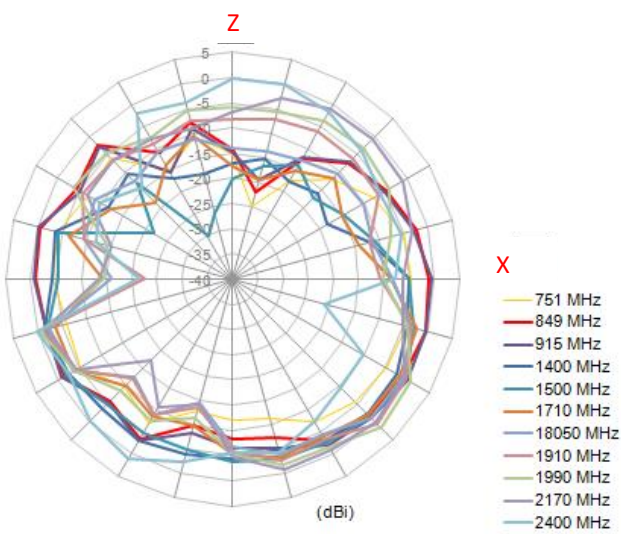

2D Radiation Pattern of the PA.700.J Antenna.

5. Mechanical Drawings (Units: mm)



3D View

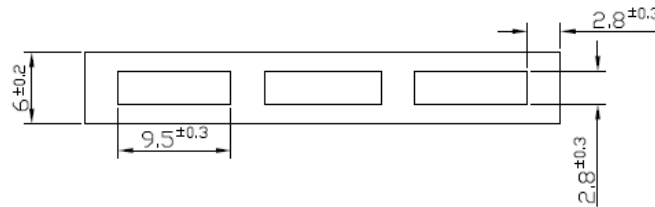

Bottom



Top

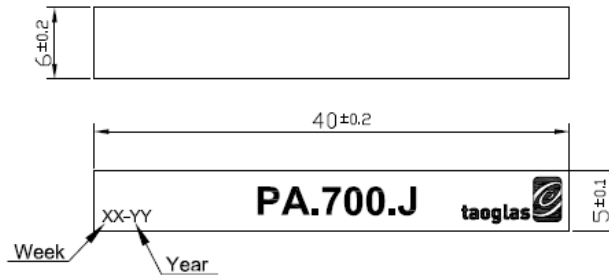

Note: Inductor Value 8.2nH for Taoglas Evaluation Board – different values may be required for different board designs

Note:

- 1. Week Batch Code
Example: 2012 Week 1=01.12
- 2. Copper Area
- 3. Clearance Area
- 4. Soldered Area
- 5. Logo & Text Ink Printing : Black

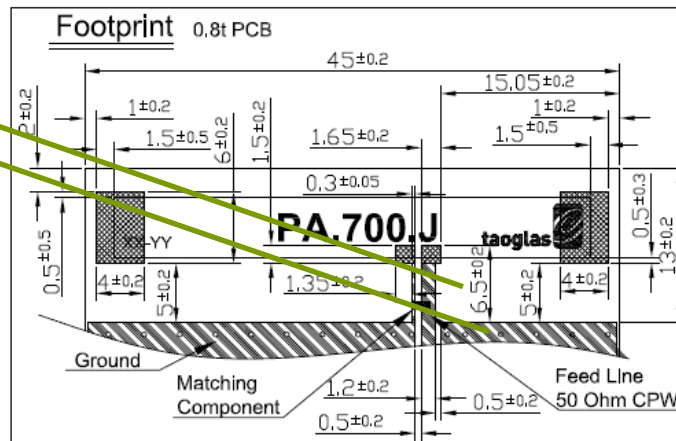

Mechanical Drawing of the PA.700.J Antenna.

5.1 Footprint

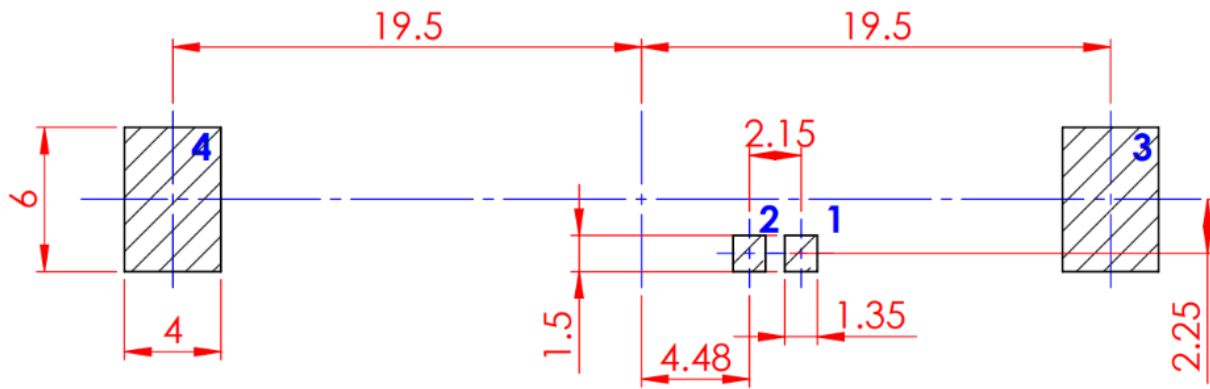

FOOTPRINT PCB
SCALE 3:1

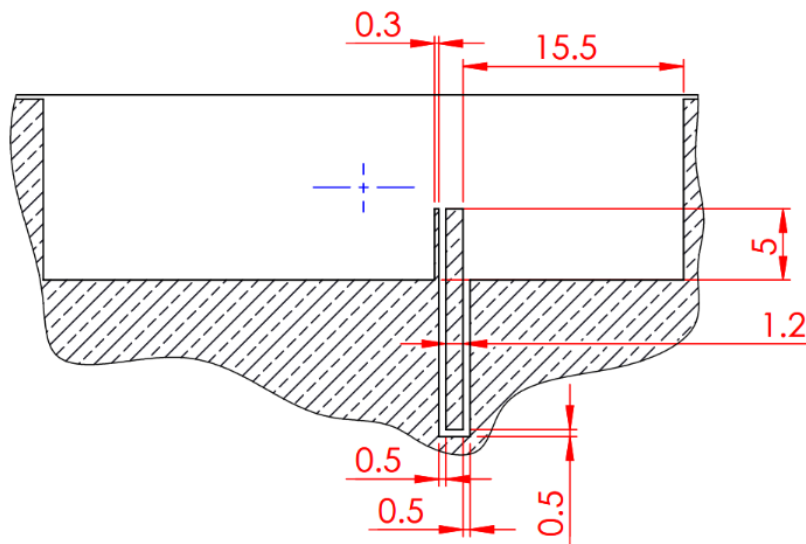

GROUND CLEARANCE TOP VIEW
(SILKSCREEN NOT SHOWN)
SCALE 2:1

6. EVB Dimensions (Unit:mm)

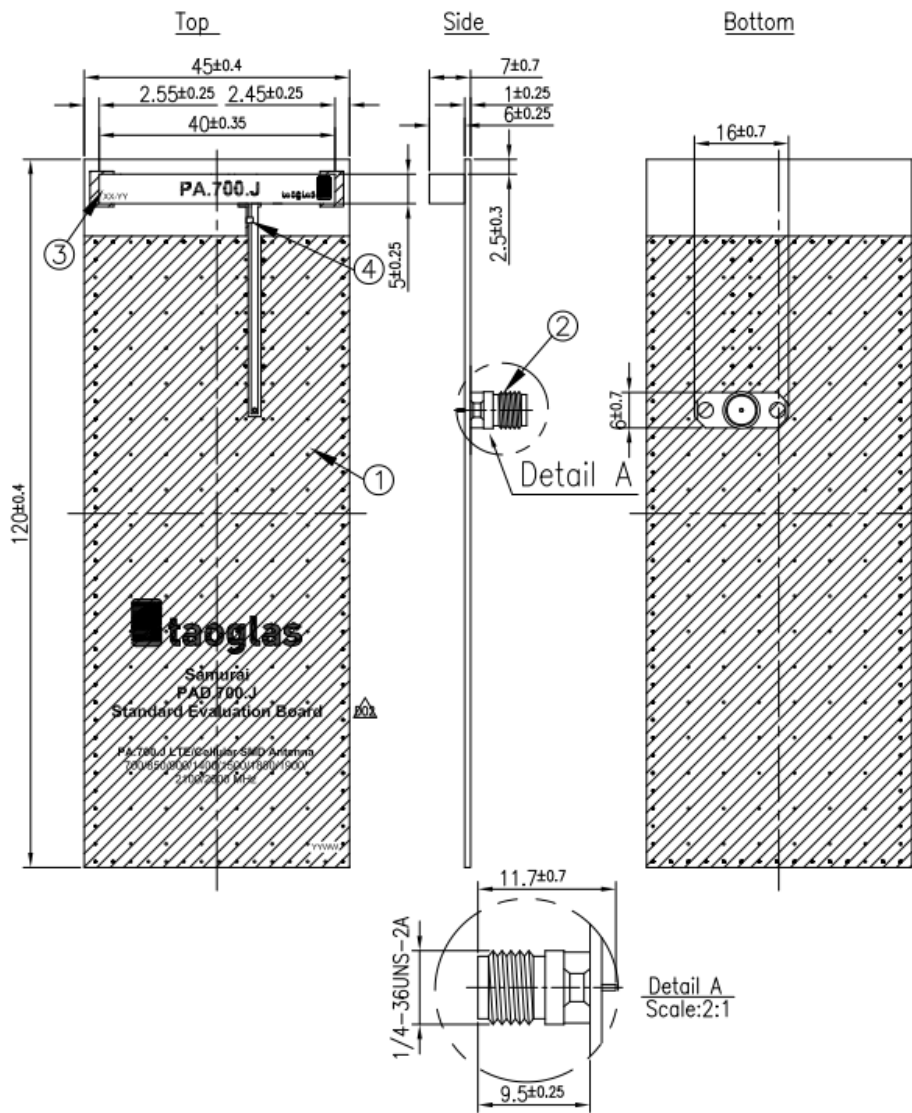

	Name	Material	Finish	QTY
1	PA.700.J EVB PCB	Composite	Black	1
2	SMA(F) ST PCB	Brass	Gold	1
3	PA.700.J Antenna	Ceramic	White	1
4	L=8.2nH Inductor	Ceramic	N/A	1

Drawing of the PA.700.J Antenna

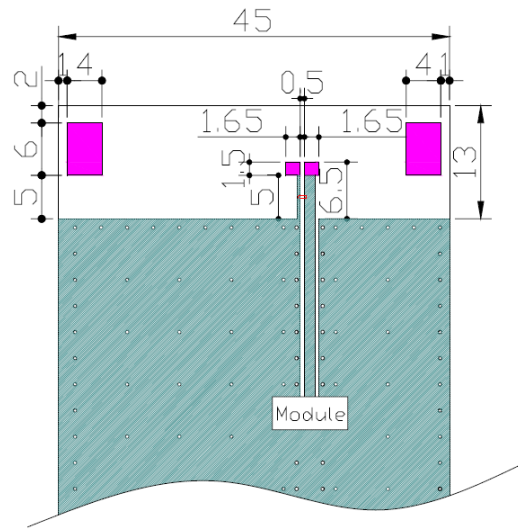

Layout dimensions of the PA.700.J Antenna.

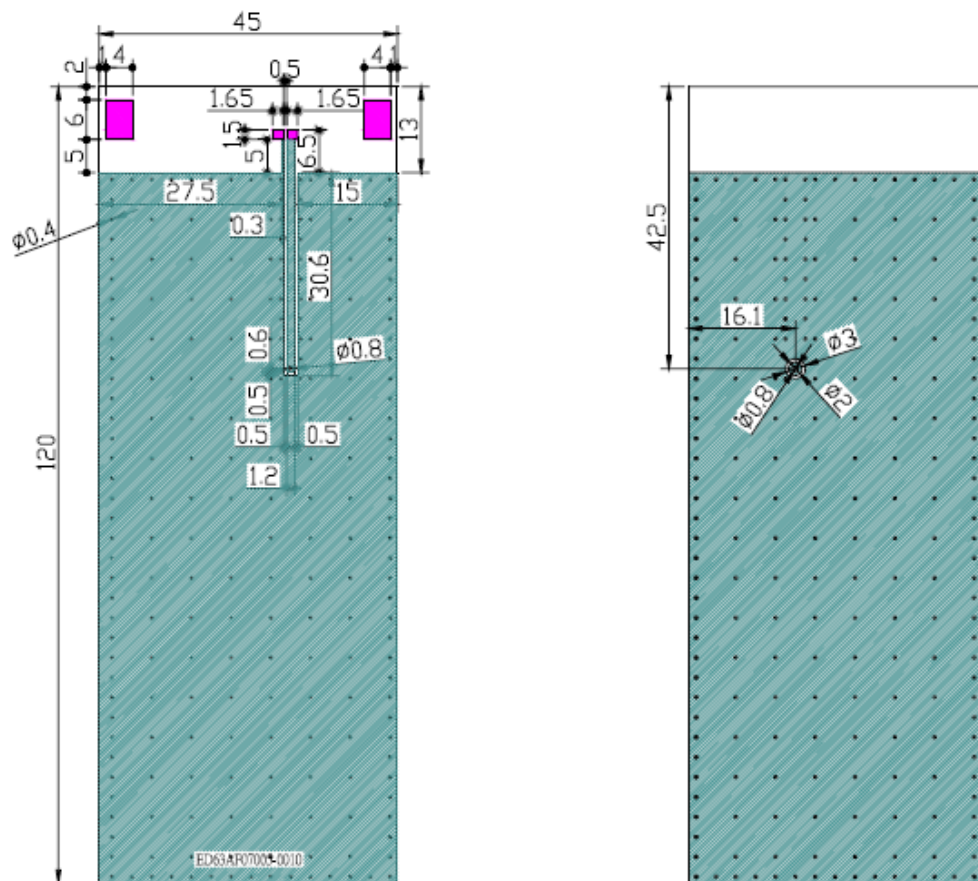

EVB Dimensions of the PA.700.J.

7. Antenna Intergration Guide

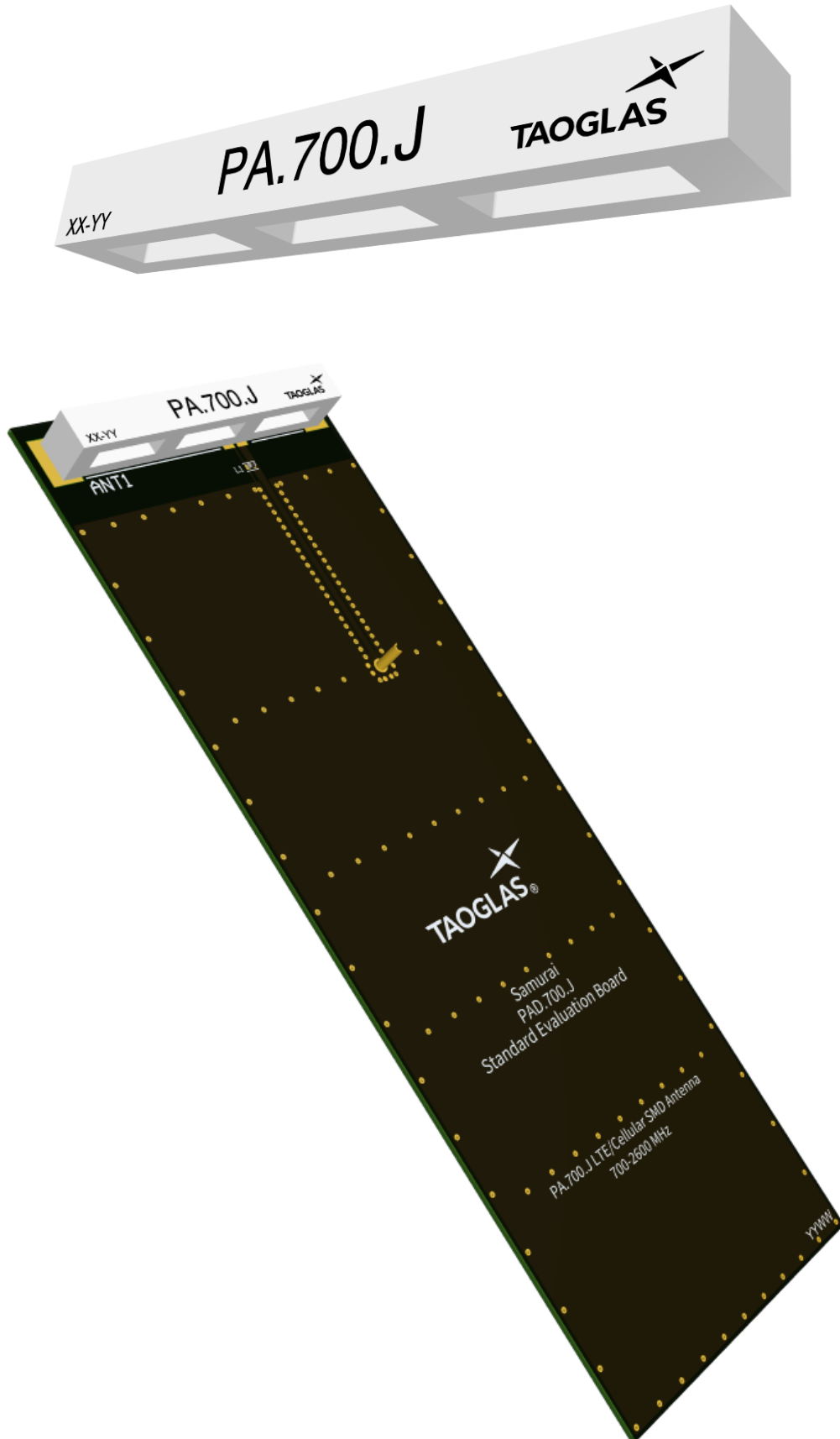

7.1 Schematic Symbol and Pin Definition

The circuit symbol for the antenna is shown below. The antenna has 4 pins with only two pins (Pin 1 and Pin 2) as functional. Pins 3 and 4 are for mechanical strength.

Pin	Description
1	RF Feed
2	Ground
3, 4	Mechanical, Not Connected

PA.700J
ANTI

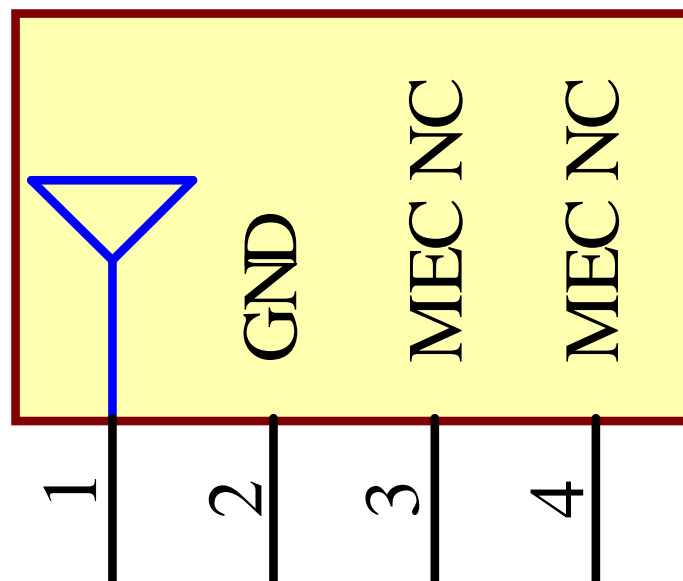

Please note you can download the design files, 3D model, 2D drawings and CST simulation files from the website here:

<https://www.taoglas.com/product/viking-pa-700j-2g3g4g-smd-pifa-antenna-2/>

7.2 Antenna Integration

Whatever the size of the PCB, the antenna should ideally be placed on the PCB's shortest side, to take advantage of the ground plane. Optimized matching components can be placed as shown.

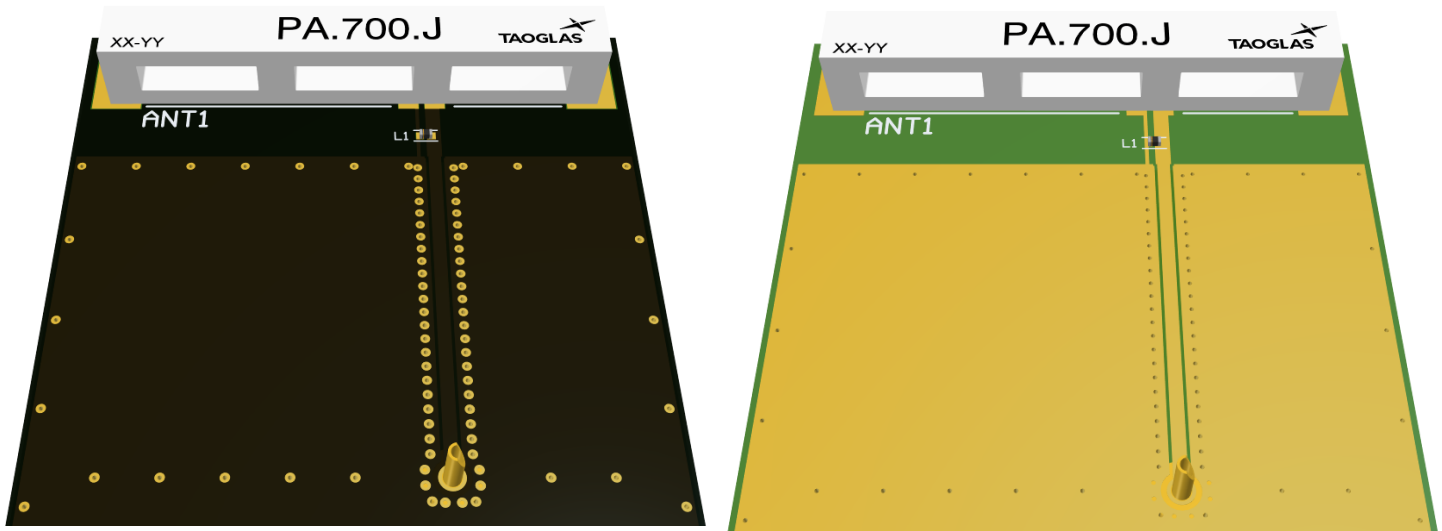

7.3 PCB Layout

The footprint and clearance on the PCB must meet the layout drawing in (Footprint Drawing). Note the placement of the optimized components. L1 is placed as close as possible to the RF feed (pad 1) but still within the transmission line.

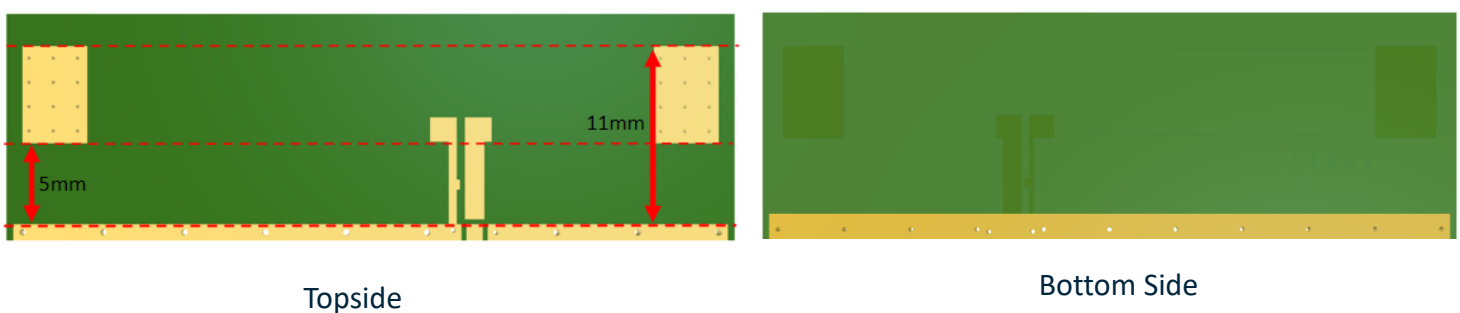

7.4 PCB Keep Out

Below shows the antenna footprint and clearance through ALL layers on the PCB. Only the antenna pads and connections to feed and GND are present within this clearance area (marked RED). The clearance area extends to 5mm from the antenna mechanical pads to the ground area. This clearance area includes the bottom side and ALL internal layers on the PCB.



Topside

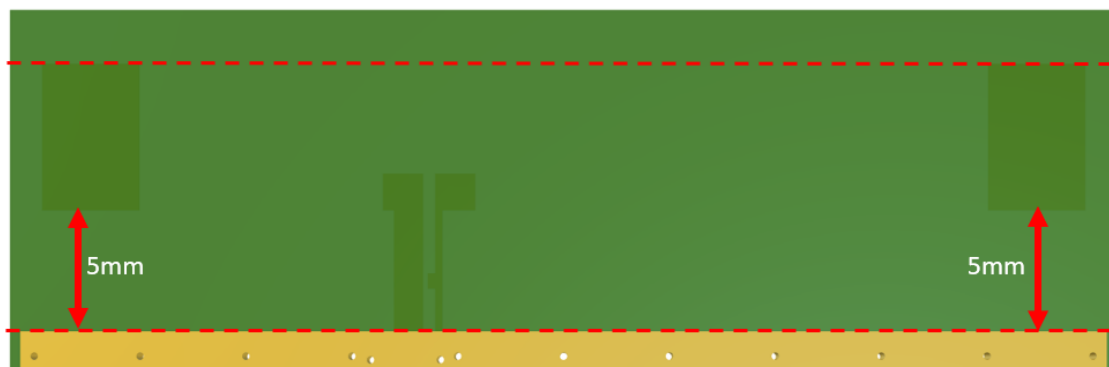

Bottom Side

7.5 Evaluation Board

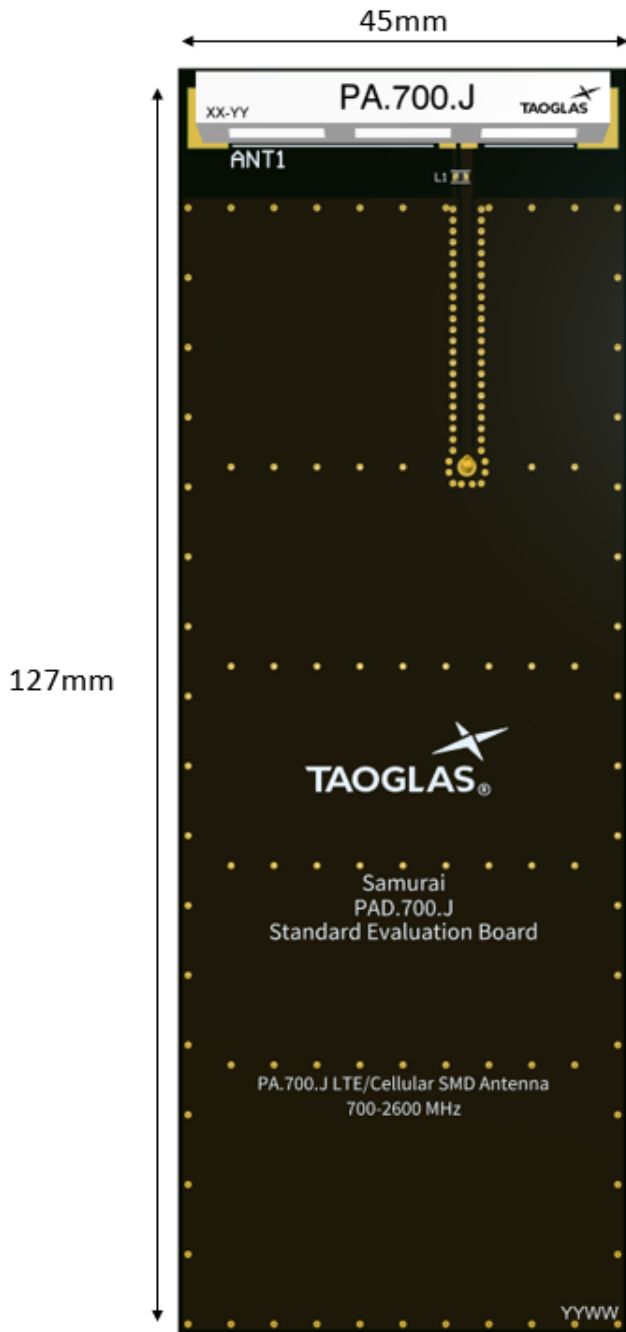

Topside



Bottom Side

7.6 Evaluation Board Ground Plane Length



7.7 Evaluation Board Matching Circuit

A matching component (L1) in parallel with the PA.700.J is required for the antenna to have optimal performance on the evaluation board, located outside of the ground plane in the space specified in the above images. Additional matching components may be necessary for your device, so we recommend incorporating extra component footprints, forming a “pi” network, between the cellular module and the edge of the ground plane.

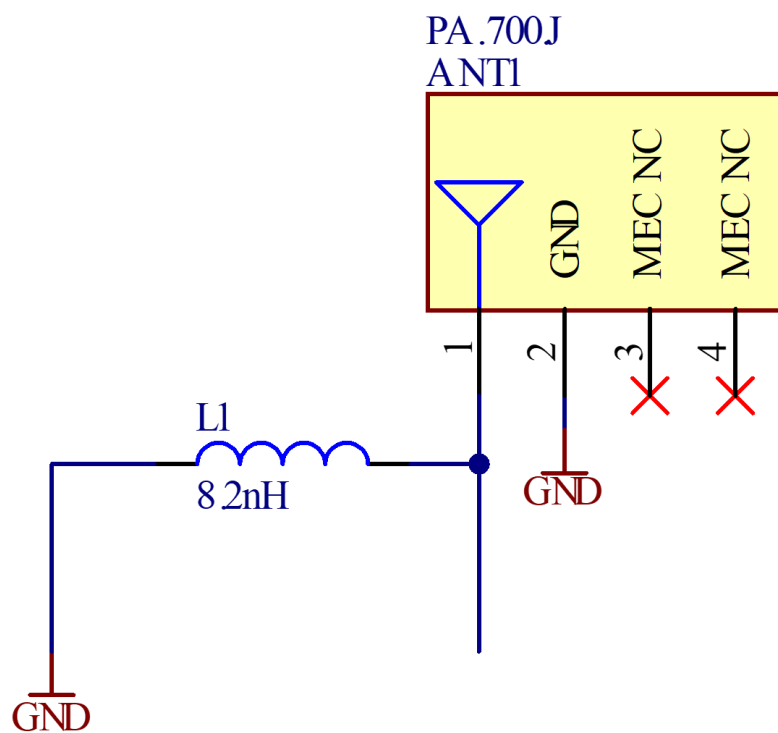

Designator	Type	Value
L1	Inductor	8.2nH

8. Packaging

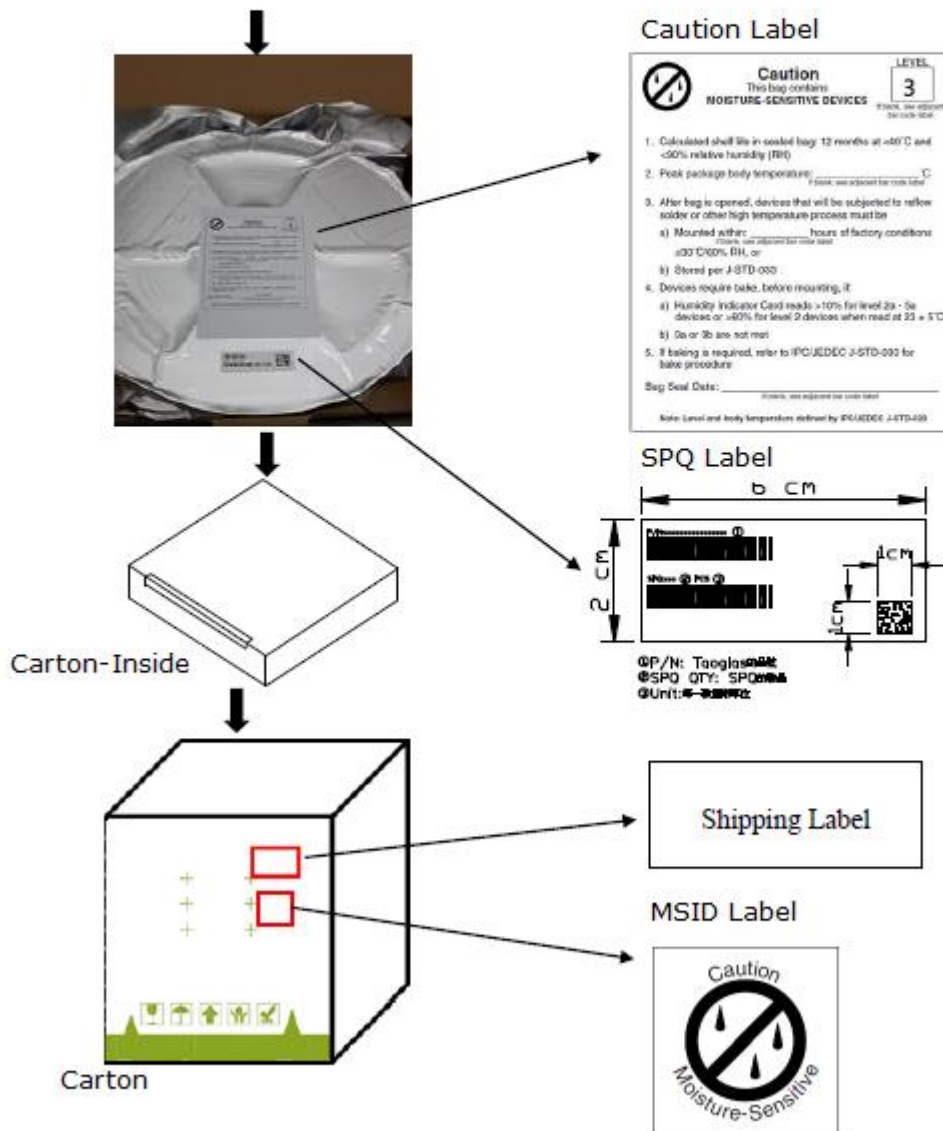
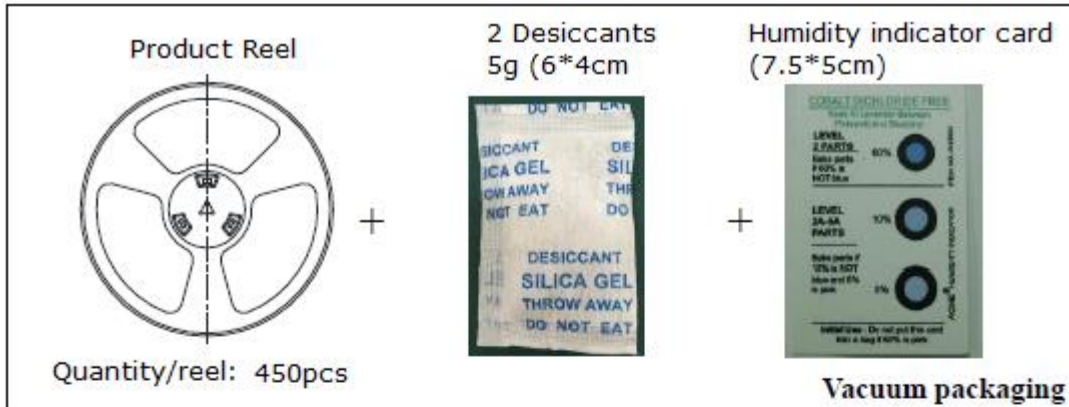

9. Solder Reflow Profile

The PA.700.J can be assembled by following the recommended soldering temperatures are as follows:

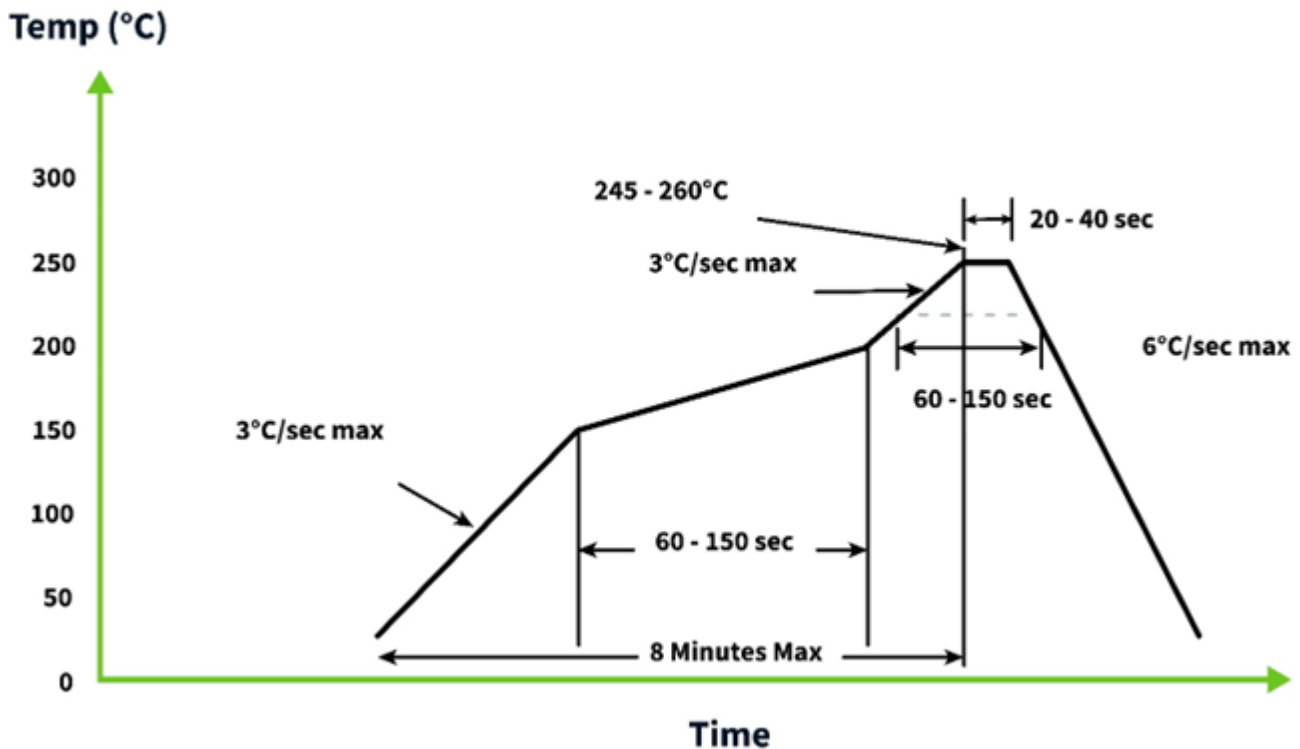

*Temperatures listed within a tolerance of +/- 10° C

Smaller components are typically mounted on the first pass, however, we do advise mounting the PA.700.J when placing larger components on the board during subsequent reflows.

Note: Soldering flux classified ROL0 under IPC J-STD-004 is recommended.

Changelog for the datasheet

SPE-12-8-017 – PA.700.J

Revision: I (Current Version)

Date:	2023-10-25
Changes:	Updated the Solder Reflow Profile and added antenna integration guide
Changes Made by:	Cesar Sousa

Previous Revisions

Revision: H

Date:	2020-11-06
Changes:	Specifications table amended - Moisture Sensitivity Level 3
Changes Made by:	Dan Cantwell

Revision: C

Date:	2012-09-27
Changes:	
Changes Made by:	Technical Writer

Revision: G

Date:	2017-04-04
Changes:	Added LTE Band Table
Changes Made by:	Peter Monahan

Revision: B

Date:	2012-06-26
Changes:	Updated format
Changes Made by:	Aine Doyle

Revision: F

Date:	
Changes:	
Changes Made by:	Technical Writer

Revision: A (Original First Release)

Date:	2022-02-22
Notes:	
Author:	Technical Writer

Revision: E

Date:	2016-10-03
Changes:	Added Samurai name
Changes Made by:	Aine Doyle

Revision: D

Date:	2013-10-04
Changes:	Added detail on Matching Component
Changes Made by:	Aine Doyle



TAOGLAS®

www.taoglas.com

