

# Features

- 2:1 and 4:1 Wide input voltage range
- SIP8 Package style
- UL94V-0 Package material

# Regulated Converters

- Continuous short circuit protected
- Low noise
- 1kVDC, 2kVDC or 3kVDC Isolation



# RSO-S(D)(Z)

**1 Watt**  
**SIP8**  
**Single & Dual**  
**Output**



UL60950-1 certified  
 CAN/CSA No. 60950-1-07 certified  
 IEC/EN60950-1 certified  
 IEC/EN60601-1 certified  
 CB Report

## Description

High-power-density, an industrial temperature range of -40°C to +100°C and extra features like On-Off-control are just some of the characteristics of this converter, ideal for highly sophisticated industrial-designs. The RSO series is available with isolation of 2kV or 3kV by choosing option „/H2“ or „/H3“. The standard version offers 2:1 input voltage range, while the “Z” version features 4:1 input voltage range, which includes an input voltage range covering both 5V and 12V supplies.

## Selection Guide

Part Number	Input Voltage Range [VDC]	Output Voltage [VDC]	Output Current [mA]	Efficiency typ. [%]	max. Capacitive Load <sup>(3)</sup> [µF]
RSO-xx3.3S	4.5-9 <sup>(1)</sup> , 9-18, 18-36, 36-72	3.3	300	68-72	3300
RSO-xx3.3SZ	9-36, 18-72				
RSO-xx05S	4.5-9 <sup>(1)</sup> , 9-18, 18-36, 36-72	5	200	73-78	1200
RSO-xx05SZ	4.5-18 <sup>(1,2)</sup> , 9-36, 18-72				
RSO-xx09S	4.5-9 <sup>(1)</sup> , 9-18, 18-36, 36-72	9	111	74-81	680
RSO-xx09SZ	4.5-18 <sup>(1,2)</sup> , 9-36, 18-72				
RSO-xx12S	4.5-9 <sup>(1)</sup> , 9-18, 18-36, 36-72	12	83	75-83	680
RSO-xx12SZ	4.5-18 <sup>(1,2)</sup> , 9-36, 18-72				
RSO-xx15S	4.5-9 <sup>(1)</sup> , 9-18, 18-36, 36-72	15	67	75-83	680
RSO-xx15SZ	4.5-18 <sup>(1,2)</sup> , 9-36, 18-72				
RSO-xx3.3D	4.5-9 <sup>(1)</sup> , 9-18, 18-36, 36-72	±3.3	±150	68-72	±1500
RSO-xx3.3DZ	9-36, 18-72				
RSO-xx05D	4.5-9 <sup>(1)</sup> , 9-18, 18-36, 36-72	±5	±100	73-76	±470
RSO-xx05DZ	4.5-18 <sup>(1,2)</sup> , 9-36, 18-72				
RSO-xx09D	4.5-9 <sup>(1)</sup> , 9-18, 18-36, 36-72	±9	±56	74-78	±470
RSO-xx09DZ	4.5-18 <sup>(1,2)</sup> , 9-36, 18-72				
RSO-xx12D	4.5-9 <sup>(1)</sup> , 9-18, 18-36, 36-72	±12	±42	75-80	±330
RSO-xx12DZ	4.5-18 <sup>(1,2)</sup> , 9-36, 18-72				
RSO-xx15D	4.5-9 <sup>(1)</sup> , 9-18, 18-36, 36-72	±15	±34	75-80	±330
RSO-xx15DZ	4.5-18 <sup>(1,2)</sup> , 9-36, 18-72				

### Notes:

- Note1: Derate to 75% if  $V_{in}$  is <5VDC (refer to „Line Derating“ graph on page 2)  
 Note2: 12V 4:1 input also requires an external 10µF capacitor (refer to „Protection Circuit“ on page 3)  
 Note3: Maximum capacitive load is defined as the capacitive load that will allow start up in under 1 second without damage the converter

## Model Numbering



### Notes:

- Note4: add „Z“ for 4:1 Input Voltage (12= 4.5-18VDC; 24= 9-36VDC; 48= 18-72VDC)  
 Note5: add suffix „/H2“ for 2kVDC isolation or „/H3“ for 3kVDC isolation, without = standard 1kVDC isolation

### Ordering Examples:

RSO-0512S:	4.5-9Vin	12Vout	Single	2:1 Input Voltage	1kVDC Isolation
RSO-0505DZ/H3	4.5-9Vin	±5Vout	Dual	4:1 Input Voltage	3kVDC Isolation
RSO-1212SZ/H2	4.5-18Vin	12Vout	Single	4:1 Input Voltage	2kVDC Isolation

Specifications (measured @ Ta= 25°C, nom. Vin, full load and after warm-up unless otherwise stated)

**BASIC CHARACTERISTICS**

Parameter	Condition		Min.	Typ.	Max.
Input Voltage Range	2:1 Input	5VDC	4.5VDC <sup>(1)</sup>		9VDC
		nom Vin= 12VDC	9VDC		18VDC
	4:1 Input	24VDC	18VDC		36VDC
		48VDC	36VDC		72VDC
Quiescent Current	nom Vin=	12VDC	4.5VDC <sup>(1,2)</sup>	40mA	18VDC
		24VDC	9VDC	32mA	36VDC
		48VDC	18VDC	25mA	72VDC
Minimum Load <sup>(6)</sup>			10%		
ON/OFF CTRL	DC-DC ON		open or high impedance		
	DC-DC OFF		external V <sub>CTRL</sub> = 5-12VDC + 1N4148 and 68Ω resistor		
Input Current of CTRL Pin	DC-DC ON			3mA	6mA
Standby Current	DC-DC OFF			10mA	
Internal Operating Frequency	2:1 Input		200kHz		500kHz
	4:1 Input		100kHz		800kHz
Output Ripple and Noise	20MHz BW				50mVp-p

**Notes:**

Note6: Operation below 10% load won't harm the converter, but specifications may not be met

**Efficiency vs. Load**

RSO-24xx

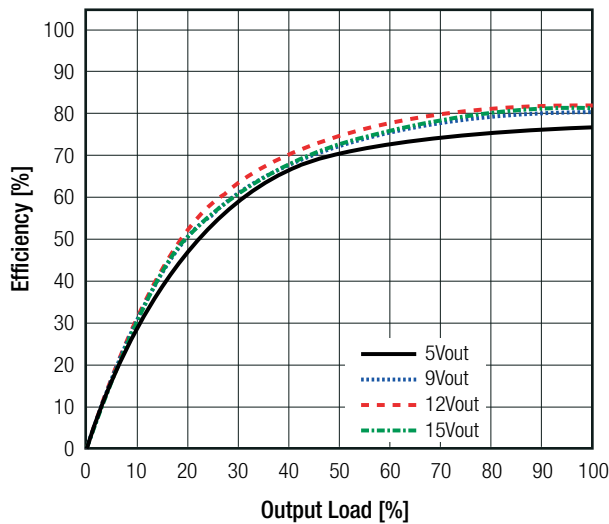

**Line Derating**

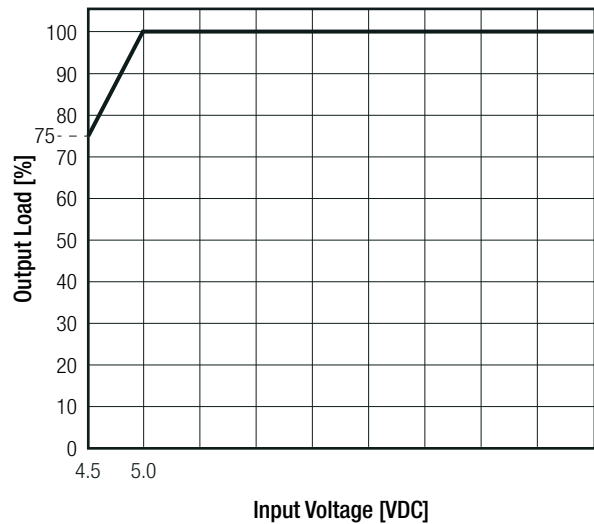

**ON/OFF CTRL**

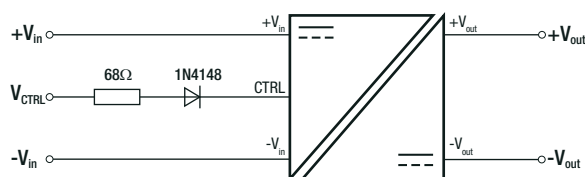

**DC-DC ON:** Open or high impedance

**DC-DC OFF:** V<sub>CTRL</sub> = 5-12VDC + 1N4148 and 68Ω resistor

continued on next page

**Specifications** (measured @ Ta= 25°C, nom. Vin, full load and after warm-up unless otherwise stated)

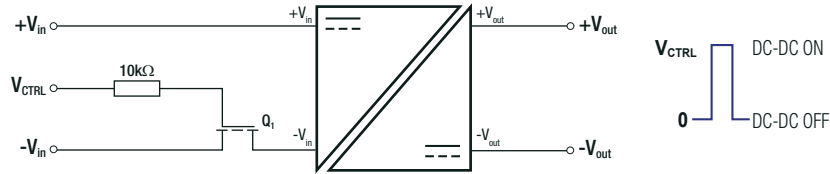

**REGULATIONS**

Parameter	Condition		Value
Output Accuracy			±2.0% typ.
Line Regulation	2:1 Input		±0.2% max.
	4:1 Input		±0.5% max.
Load Regulation	10% to 100% full load	2:1 Input	0.4% max.
		4:1 Input	0.5% typ.

**PROTECTIONS**

Parameter	Type		Value	
Short Circuit Protection (SCP)	below 100mΩ		continuous, auto recovery	
Isolation Voltage <sup>(7)</sup>	standard without suffix	tested for 1 second	1kVDC	
		rated for 1 minute	500VAC/60Hz	
	/H2 version	tested for 1 second	2kVDC	
		rated for 1 minute	1kVAC/60Hz	
	/H3 version	tested for 1 second	3kVDC	
		rated for 1 minute	1.5kVAC/60Hz	
Isolation Resistance			1GΩ min.	
Isolation Capacitance	standard without suffix	2:1 Input	Single Dual Single	10pF min. / 40pF typ. / 60pF max. 120pF min. / 170pF typ. / 250pF max. 200pF max.
		2:1 Input		
4:1 Input				
/H2 and /H3 version	2:1 Input	Single/Dual	5pF min. / 30pF typ. / 60pF max. 30pF max.	
	4:1 Input	Single/Dual		
Insulation Grade			basic (IEC/EN60950-1) functional (IEC/EN6060-1)	

**Notes:**

Note7: For repeat Hi-Pot testing, reduce the time and/or the test voltage

Note8: Refer to local safety regulations if input over-current protection is also required. Recommended fuse: slow blow type

**Protection Circuit**

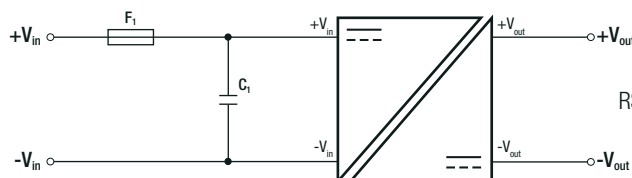

RSO-12xxSZ(DZ) requires a 10μF MLCC capacitor (C1) on input side

**ENVIRONMENTAL**

Parameter	Condition	Value
Operating Temperature Range	with derating @ free air convection (see graph)	-40°C to +100°C
Operating Altitude		5000m

continued on next page

**Specifications** (measured @ Ta= 25°C, nom. Vin, full load and after warm-up unless otherwise stated)

Parameter	Condition		Value
Operating Humidity	non-condensing		95% RH max.
Pollution Degree			PD2
MTBF	according to MIL-HDBK-217F, G.B.	+25°C	1685 x 10 <sup>3</sup> hours
		+85°C	254 x 10 <sup>3</sup> hours

**Derating Graph**

(@ Chamber and free air convection)

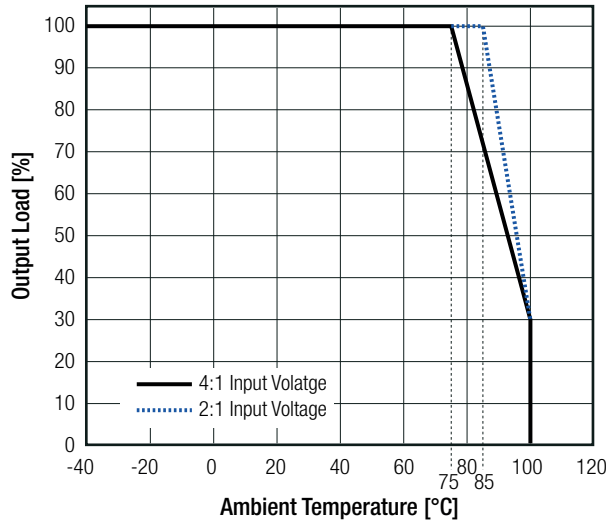

**SAFETY AND CERTIFICATIONS**

Certificate Type (Safety)	Report / File Number	Standard
Information Technology Equipment, General Requirements for Safety (LVD)	SPCLVD1605077-10	IEC60950-1, 2nd Edition, AM2: 2013 EN60950-1, 2nd Edition, A2:2013
Information Technology Equipment, General Requirements for Safety (CB)	L0339L48-CB-1-B1	IEC60950-1:2005, 2nd Edition + A2:2013
Information Technology Equipment, General Requirements for Safety	E224736-A34-UL	UL60950-1, 2nd Edition, 2014 CAN/CSA C22.2 No. 60950-1-07
Medical Electric Equipment, General Requirements for Safety and Essential Performance	WD-SE-R-180675-A0	IEC60601-1:2005 + C2:2007 + A1:2012, 3rd Edition EN60601-1:2006 + A1:2013 + A12:2014
EAC	RU-AT.AB49.B.09571	TP TC 004/2011
RoHS2		RoHS 2011/65/EU + AM2015/863

EMC Compliance	Condition	Standard / Criterion
Electromagnetic compatibility of multimedia equipment - Emission requirements <sup>(9)</sup>	with external filter (see filter suggestion below)	EN55032, Class A EN55032, Class B

**EMC Filtering Suggestions according to EN55032**

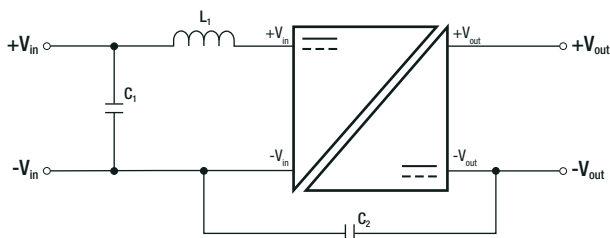

**Notes:**

Note9: Filter suggestions are valid for indicated part numbers only.  
For other part numbers, please contact RECOM tech support for advice.

**Component List Class A**

Model	C1	C2	L1
RSO-0505S	10µF/100V MLCC	N/A	<a href="#">3.9µH choke RLS-397</a>
RSO-1205S			
RSO-2405S			
RSO-4805S			

**Component List Class B**

Model	C1	C2	L1
RSO-0505S	10µF/100V MLCC	2.2nF	<a href="#">5.6µH choke RLS-567</a>
RSO-1205S			
RSO-2405S			
RSO-4805S			<a href="#">12µH choke RLS-126</a>

**Specifications** (measured @ Ta= 25°C, nom. Vin, full load and after warm-up unless otherwise stated)

**DIMENSION AND PHYSICAL CHARACTERISTICS**

Parameter	Type	Value
Material	case potting PCB	non-conductive black plastic, (UL94 V-0) epoxy, (UL94 V-0) FR4, (UL94 V-0)
Dimension (LxWxH)		21.8 x 11.1 x 9.2mm
Weight		4.7g typ.

**Dimension Drawing (mm)**

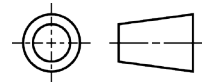
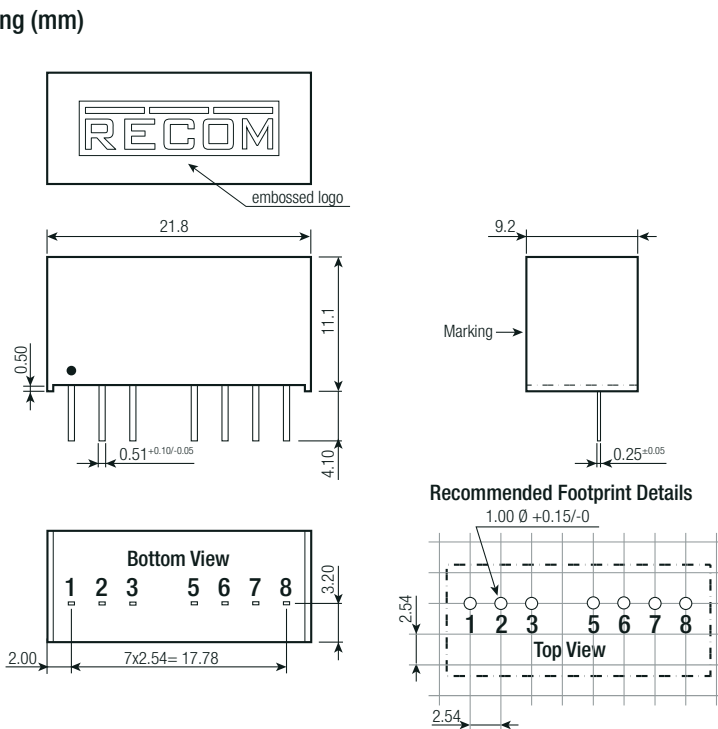

**Pinning information**

Pin #	Single	Dual
1	-Vin	-Vin
2	+Vin	+Vin
3	CTRL <sup>(10)</sup>	CTRL <sup>(10)</sup>
5	NC	NC
6	+Vout	+Vout
7	-Vout	COM
8	NC <sup>(11)</sup>	-Vout

NC= no connection  
Tolerance: xx.x= ±0.5mm  
xx.xx= ±0.25mm

**Notes:**

Note10: This pin provides an Off function which puts the converter into a low power mode. When the pin is 'high' the converter is OFF and when the pin is open the converter is ON. There is no allowed low state for this pin. (refer to „ON/OFF CTRL“ on page 2)

Note11: This pin is used internally. No external connection allowed

**PACKAGING INFORMATION**

Parameter	Type	Value
Packaging Dimension (LxWxH)	tube	520.0 x 17.0 x 10.0mm
Packaging Quantity	tube	22pcs
Storage Temperature Range		-55°C to +125°C
Storage Humidity		95% RH max.