

Quad Single Supply Comparator

IL339

The IL339 consists of four independent precision voltage comparators with an offset voltage specification as low as 2.0 mV max for four comparators which were designed specifically to operate from a single power supply over a wide range of voltages.

Application areas include limit comparators, simple analog to digital converters; pulse, squarewave and time delay generators; wide range VCO; MOS clock timers; multivibrators and high voltage digital logic gates.

- Single or Split Supply Operation
- Low Input Bias Current
- Low Input Offset Current
- Input Common Mode Voltage Range to Gnd
- Low Output Saturation Voltage
- TTL and CMOS Compatible

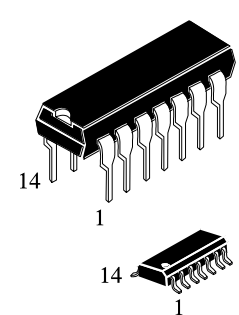

N SUFFIX
PLASTIC

D SUFFIX
SOIC

ORDERING INFORMATION
 IL339N Plastic
 IL339D SOIC
 $T_A = -40^\circ$ to 85° C for all packages.

LOGIC DIAGRAM

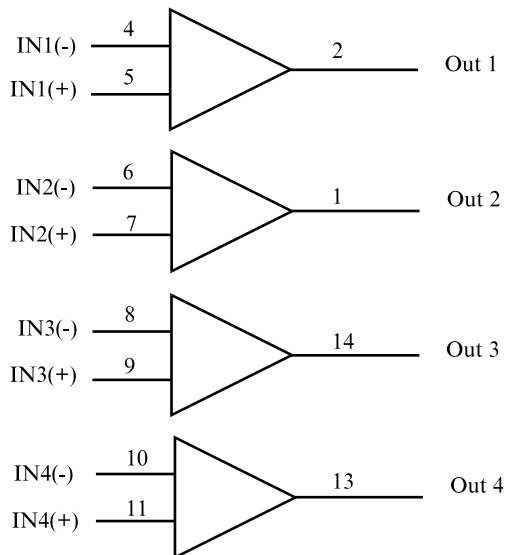

PIN 3 = V_{CC}
 PIN 12 = GND

PIN ASSIGNMENT

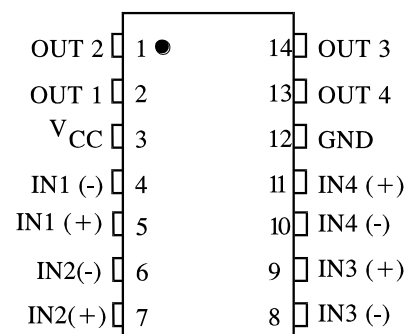

MAXIMUM RATINGS*

Symbol	Parameter	Value	Unit
V_{CC}	Power Supply Voltages		
	Single Supply Split Supplies	36 ± 18	V
V_{IDR}	Input Differential Voltage Range	36	V
V_{ICR}	Input Common Mode Voltage Range (1)	-0.3 to V_{CC}	V
I_{SC}	Output Short Circuit to Ground	Continuous	
I_{IN}	Input Current, per pin (2)	50	mA
T_J	Junction Temperature		
	Plastic Packages	150	$^{\circ}\text{C}$
T_{stg}	Storage Temperature	-65 to +150	$^{\circ}\text{C}$
T_L	Lead Temperature, 1mm from Case for 10 Seconds	260	$^{\circ}\text{C}$
P_D	Power Dissipation @ $T_A=25^{\circ}\text{C}$		
	Plastic Package	1.0	W
	Derate above 25°C	8.0	mW/ $^{\circ}\text{C}$

* Stresses beyond those listed under "absolute maximum ratings" may cause permanent damage to the device. These are stress ratings only and functional operation of the device at these or any other conditions beyond those indicated under "recommended operating conditions" is not implied.

Exposure to absolute-maximum-rated conditions for extended periods may affect device reliability.

Functional operation should be restricted to the Recommended Operating Conditions.

Notes:

1. Split Power Supplies.

2. $V_{IN} < -0.3\text{V}$. This input current will only exist when voltage at any of the input leads is driven negative.

RECOMMENDED OPERATING CONDITIONS

Symbol	Parameter	Min	Max	Unit
V_{CC}	DC Supply Voltage	± 2.5 or 5.0	± 15 or 30	V
T_A	Operating Temperature, All Package Types	-40	+85	$^{\circ}\text{C}$

This device contains protection circuitry to guard against damage due to high static voltages or electric fields. However, precautions must be taken to avoid applications of any voltage higher than maximum rated voltages to this high-impedance circuit. For proper operation, V_{IN} and V_{OUT} should be constrained to the range $\text{GND} \leq (V_{IN} \text{ or } V_{OUT}) \leq V_{CC}$.

Unused inputs must always be tied to an appropriate logic voltage level (e.g., either GND or V_{CC}). Unused outputs must be left open.

DC ELECTRICAL CHARACTERISTICS ($T_A = -40$ to $+85^\circ\text{C}$)

Symbol	Parameter	Test Conditions	Guaranteed Limit			Unit
			Min	Typ	Max	
V_{IO}	Input Offset Voltage	$V_0=1.4\text{V}$ $V_{CC}=5.0\text{-}30\text{V}; R_S \leq 100\Omega$ $V_{ICR}=0\text{V} - (V_{CC}-1.5)\text{V}$	-		9.0 5.0*	mV
I_{IB}	Input Bias Current	$V_0=1.4\text{V}$ $V_{CC}=5.0\text{-}30\text{V}$ $V_{ICR}=0\text{V} - (V_{CC}-1.5)\text{V}$	-		400	nA
I_{IO}	Input Offset Current	$V_0=1.4\text{V}$ $V_{CC}=5.0\text{-}30\text{V}$ $V_{ICR}=0\text{V} - (V_{CC}-1.5)\text{V}$	-		± 150	nA
V_{ICR}	Input Common Mode Voltage Range	$V_{CC}=5.0\text{-}30\text{V}$	0		$V_{CC}-2.0\text{V}$	V
I_{CC}	Supply Current	$R_L = \infty, V_{CC}=5.0$ $R_L = \infty, V_{CC}=30\text{V}$	- -		2.0* 2.5*	mA
A_{VOL}	Voltage Gain	$V_{CC}=15\text{V}, R_L=15\text{K}\Omega$	-	200*	-	V/mV
t_1	Large Signal Response Time	$V_{IN}=\text{TTL Logic Swing}$, $V_{ref}=1.4\text{V}, V_{CC}=5.0\text{V}$, $R_L=5.1\text{K}\Omega, V_{RL}=5.0\text{V}$	-	300*	-	ns
t_2	Response Time	$V_{CC}=5.0\text{V}, R_L=5.1\text{K}\Omega$, $V_{RL}=5.0\text{V}$	-	1.3*	-	μs
I_{sink}	Output Sink Current	$V_{I(-)}=1.0\text{V}, V_{I(+)}=0\text{V}$, $V_0 \leq 1.5\text{V}, V_{CC}=5.0\text{V}$	6.0*	-	-	mA
V_{sat}	Saturation Voltage	$V_{I(-)}=1.0\text{V}, V_{I(+)}=0\text{V}$, $I_{sink} \leq 4.0\text{mA}, V_{CC}=5.0\text{V}$	-	-	700	mV
I_{OL}	Output Leakage Current	$V_{I(+)}=1.0\text{V}, V_{I(-)}=0\text{V}$, $V_0=5.0\text{V}$ $V_0=30\text{V}$		0.1*	1000	nA
V_{IDR}	Differential Input Voltage Range	All $V_{IN} \geq \text{GND}$ or $V\text{-Supply}$ (if used)			V_{CC}^*	V

*=@25°C

TYPICAL PERFORMANCE CHARACTERISTICS

($V_{CC}=1.5V$, $T_A=+25^{\circ}C$, (each comparator))

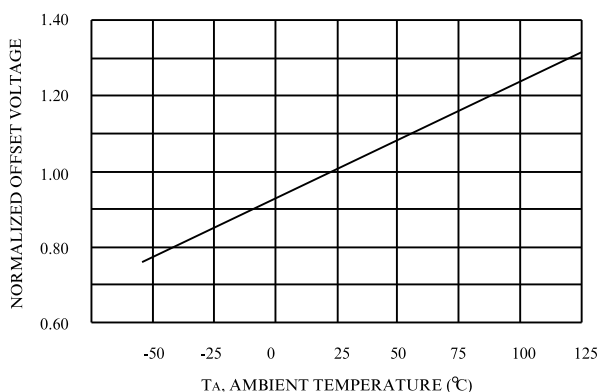

Figure 1. Normalized Input Offset Voltage

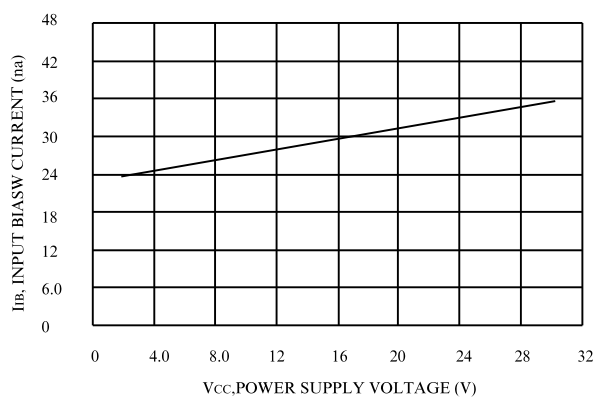

Figure 2. Input Bias Current

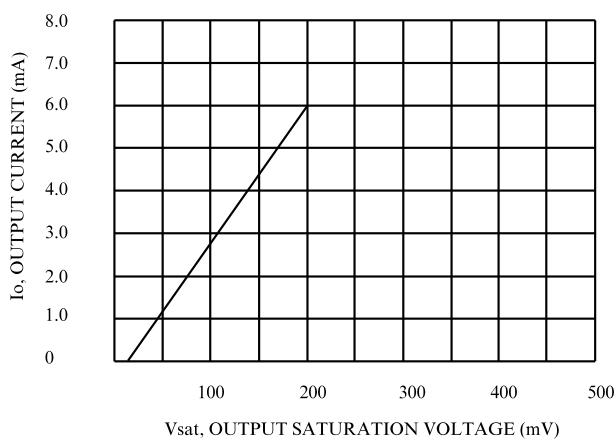
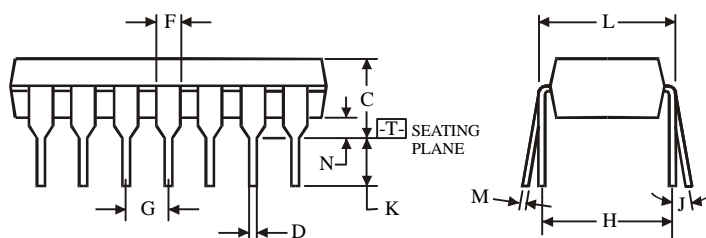
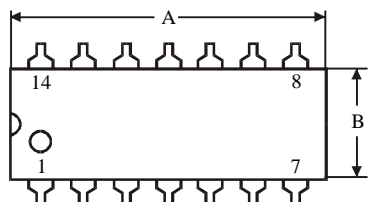
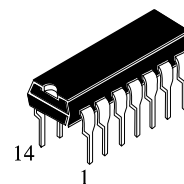

Figure 3. Output Sink Current versus Output Saturation Voltage

**N SUFFIX PLASTIC DIP
(MS - 001AA)**



$$\oplus 0.25 (0.010) \text{ (M) T}$$

NOTES:

- Dimensions "A", "B" do not include mold flash or protrusions.
Maximum mold flash or protrusions 0.25 mm (0.010) per side.

Symbol	Dimension, mm	
	MIN	MAX
A	18.67	19.69
B	6.1	7.11
C		5.33
D	0.36	0.56
F	1.14	1.78
G	2.54	
H	7.62	
J	0°	10°
K	2.92	3.81
L	7.62	8.26
M	0.2	0.36
N	0.38	

**D SUFFIX SOIC
(MS - 012AB)**

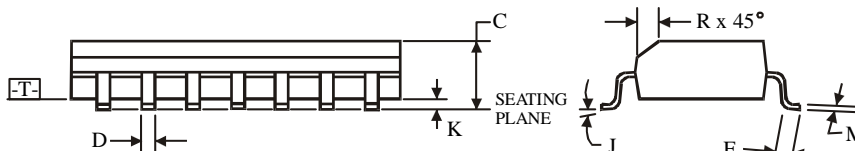
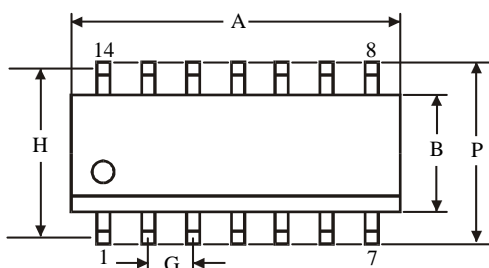
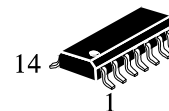

$$\oplus 0.25 (0.010) \text{ (M) T C (M)}$$

NOTES:

- Dimensions A and B do not include mold flash or protrusion.
- Maximum mold flash or protrusion 0.15 mm (0.006) per side
for A; for B - 0.25 mm (0.010) per side.

Symbol	Dimension, mm	
	MIN	MAX
A	8.55	8.75
B	3.8	4
C	1.35	1.75
D	0.33	0.51
F	0.4	1.27
G	1.27	
H	5.27	
J	0°	8°
K	0.1	0.25
M	0.19	0.25
P	5.8	6.2
R	0.25	0.5