

# Features

# Regulated Converter

- 85 to 305VAC input voltage range
- 4kVAC isolation strength
- Operating temperature: -40°C to +90°C
- Full load output power up to 80°C
- Low profile of 15.4mm
- Standby mode optimized for Ecodesigns
- EMC compliance EN55032 class “B”



## RAC02E-K/277

2 Watt  
1.35” x 0.88”  
Single Output

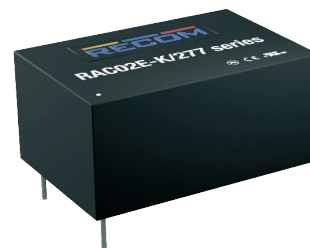

### Description

The cost-efficient RAC02E-K/277 AC/DC converter series has an input range of nominal 100VAC to an enhanced 277VAC, delivering an uncompromising 2 watts of output power with tightly regulated outputs from 3.3V to 24VDC. These low profile, encapsulated print-mountable modules in an industry-standard pinout deliver full output power from -40°C to +80°C and are certified for operation up to +90°C air ambient with output power reduced to 1.2W. This series of AC/DC modules holds international safety certifications for industrial, domestic, ITE, use with 4kVAC input to output isolation, they are suitable for worldwide applications in automation control, industry 4.0, IoT. Due to their LPS (Limited Power Source) and reinforced class II installation rating for floating outputs and their significantly wide margin to class B EMC compliance without external components, these are the easiest to use, versatile power modules in the industry.

### Selection Guide

Part Number	Input Voltage Range [VAC]	nom. Output Voltage [VDC]	Output Current [mA]	Efficiency typ. <sup>(1)</sup> [%]
RAC02E-3.3SK/277	85-305	3.3	600	68
RAC02E-05SK/277	85-305	5	400	72
RAC02E-12SK/277	85-305	12	167	73
RAC02E-15SK/277	85-305	15	133	75
RAC02E-24SK/277	85-305	24	83	78

#### Notes:

Note1: Efficiency is tested at nominal input and full load at +25°C ambient

### Model Numbering



### Specifications (measured @ Ta= 25°C, nom. Vin, full load and after warm-up unless otherwise stated)

BASIC CHARACTERISTICS					
Parameter	Condition		Min.	Typ.	Max.
Nominal Input Voltage	50/60Hz		100VAC		277VAC
Operating Range <sup>(2,3)</sup>	47-63Hz DC		85VAC 120VDC	277VAC	305VAC 430VDC
Input Current	115VAC 230VAC 277VAC				60mA 40mA 30mA
Inrush Current	cold start at 25°C	115VAC 230VAC 277VAC			10A 20A 25A
No load Power Consumption					75mW
ErP Standby Mode Conformity (Maximum output power available for stated maximum input power)	Input Power= 0.5W 1.0W				0.32W 0.67W
<b>Notes:</b>					
Note2: The products were submitted for safety files at AC-Input operation. (90-305VAC)					
Note3: Refer to “Derating Graph <sup>(7)</sup> ”					

continued on next page

**YOU MAY ALSO LIKE**  
Please consider this alternatives:

**RAC03-K**

UL/IEC/EN62368-1 certified  
CAN/GSA C22.2 No. 62368-1 certified  
IEC/EN61558-1/2-16 certified  
EN IEC60335-1 pending  
EN55032/EN55035 compliant  
EN55014-1/-2 compliant  
EN61204-3 compliant  
FCC Part 15 compliant  
CB Report

**Specifications** (measured @ Ta= 25°C, nom. Vin, full load and after warm-up unless otherwise stated)

**BASIC CHARACTERISTICS**

Parameter	Condition	Min.	Typ.	Max.
Input Frequency Range	AC Input	47Hz		63Hz
Minimum Load		0%		
Power Factor	115VAC	0.55		
	230VAC	0.45		
	277VAC	0.4		
Start-up Time			15ms	
Rise Time			10ms	
Hold-up Time	115VAC	15ms		
	230VAC	80ms		
	277VAC	120ms		
Internal Operating Frequency	100% load at nominal Vin			132kHz
Output Ripple and Noise <sup>(4)</sup>	20MHz BW	3.3, 5Vout others		120mVp-p 1% of Vout

**Notes:**

Note4: Measurements are made with a 0.1µF MLCC & 10µF E-cap in parallel across output. (low ESR)

**Efficiency vs. Load**

**RAC02E-3.3SK/277**

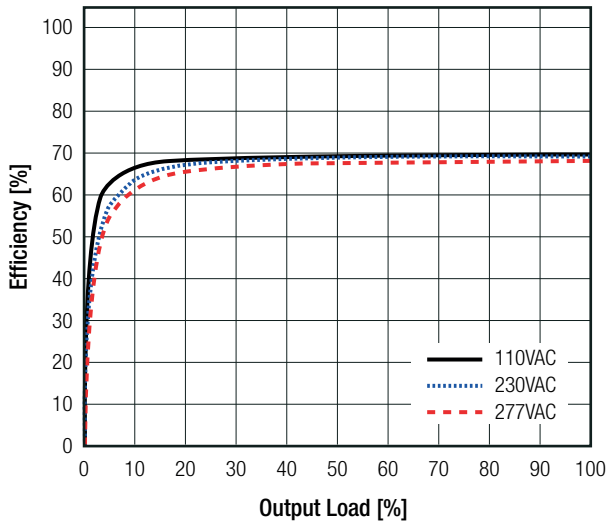

**RAC02E-05SK/277**

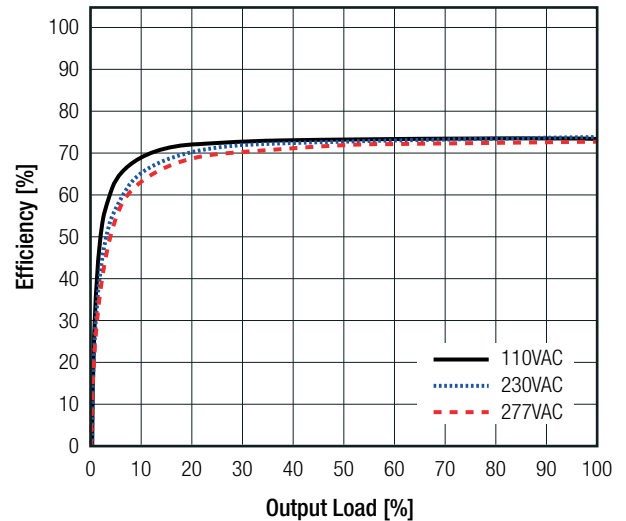

**RAC02E-12SK/277 / RAC02E-24SK/277**

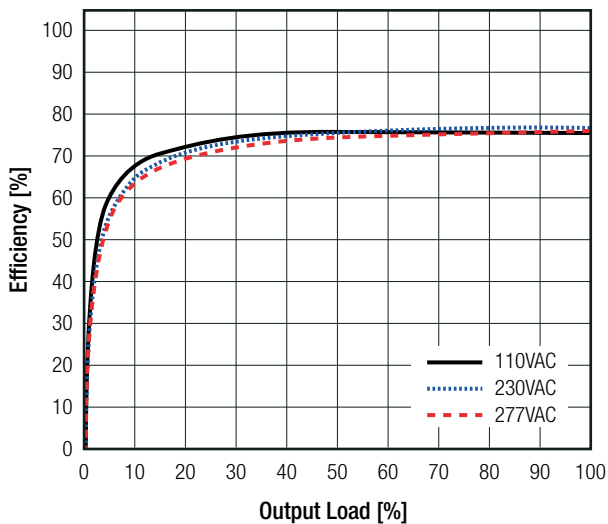

**RAC02E-15SK/277**

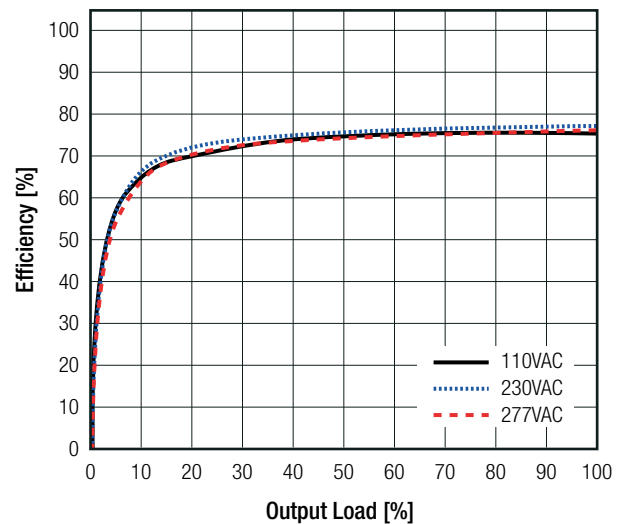

continued on next page

**Specifications** (measured @ Ta= 25°C, nom. Vin, full load and after warm-up unless otherwise stated)

**REGULATIONS**

Parameter	Condition	Value
Output Accuracy	3.3, 5Vout others	±2.0% typ. ±1.0% typ.
Line Regulation	low line to high line, full load	±0.5% typ.
Load Regulation <sup>(5)</sup>	10% to 100% load	0.5% typ.
Transient Response	10% load step change recovery time	6.0% max. 350µs max.

**Notes:**

Note5: Operation below 10% load will not harm the converter, but specifications may not be met

**Deviation vs. Load**

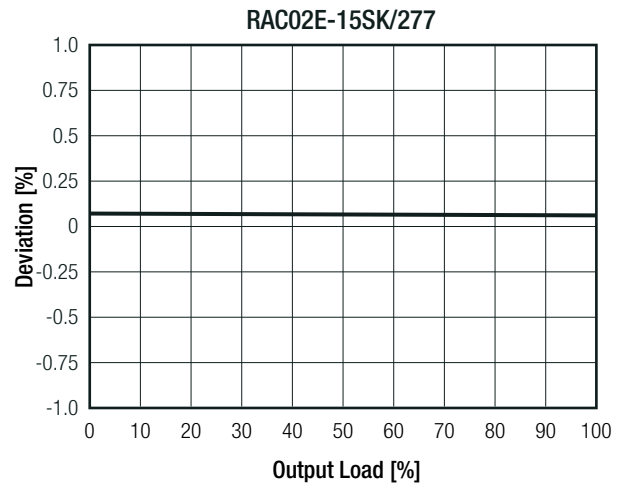
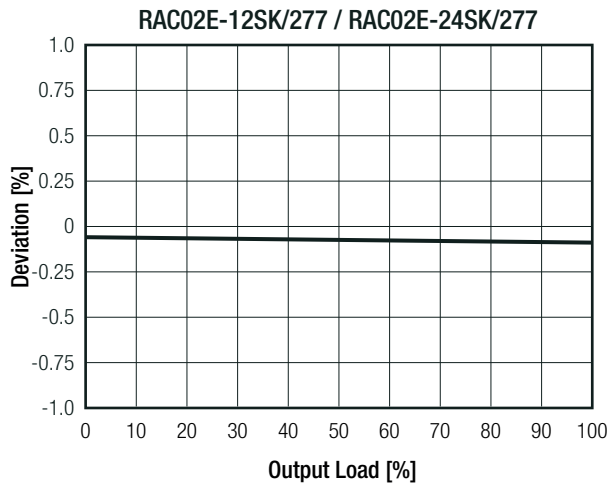
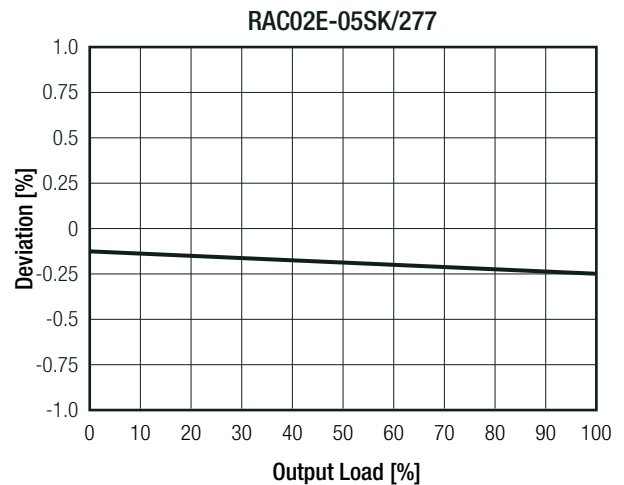
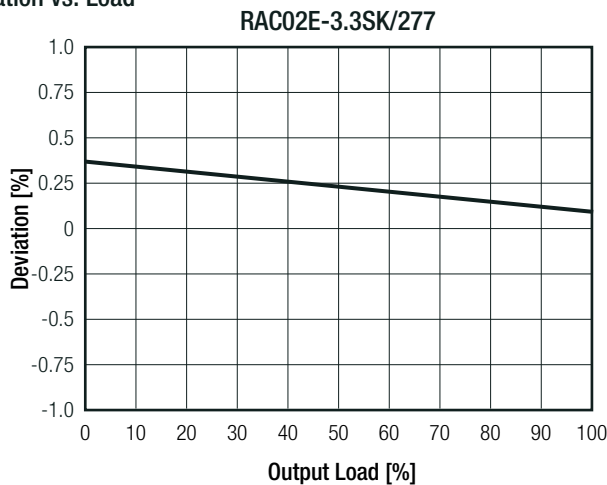

**PROTECTIONS**

Parameter	Type	Value
Input Fuse	internal	fusible resistor
Short Circuit Protection (SCP)		Hiccup mode, auto recovery
Over Voltage Protection (OVP)		120% - 260%, hiccup mode
Over Current Protection (OCP)		120% - 300%, hiccup mode
Over Voltage Category (OVC)		OVCII
Isolation Voltage <sup>(6)</sup>	I/P to O/P	1 minute 4kVAC

**Notes:**

Note6: For repeat Hi-Pot testing, reduce the time and/or the test voltage

continued on next page

**Specifications** (measured @ Ta= 25°C, nom. Vin, full load and after warm-up unless otherwise stated)

**PROTECTIONS**

Parameter	Condition	Value
Isolation Resistance	I/P to O/P, Isolation Voltage 500VDC	1GΩ min.
Isolation Capacitance	I/P to O/P, 100KHz/0.1V	100pF max.
Leakage Current	@ 277VAC	0.25mA max.
Insulation Grade		reinforced

**ENVIRONMENTAL**

Parameter	Condition		Value
Operating Temperature Range	@ natural convection 0.1m/s	refer to "Derating Graph (7)"	-40°C to +85/90°C
Maximum Case Temperature			+95°C
Temperature Coefficient			±0.03%/K
Operating Altitude			2000m
Operating Humidity	non-condensing		20% - 90% RH max.
Pollution Degree			PD2
Vibration			10-500Hz, 2G 10min./1cycle, period 60min. each along x,y,z axes
MTBF	according to MIL-HDBK-217F, G.B.	+25°C +40°C	1850 x 10 <sup>3</sup> hours 1510 x 10 <sup>3</sup> hours
Design Lifetime	230VAC/60Hz and full load +50°C		>30 x 10 <sup>3</sup> hours

**Derating Graph (7)**

(@ Chamber and natural convection 0.1m/s)

**RAC02E-3.3SK/277**

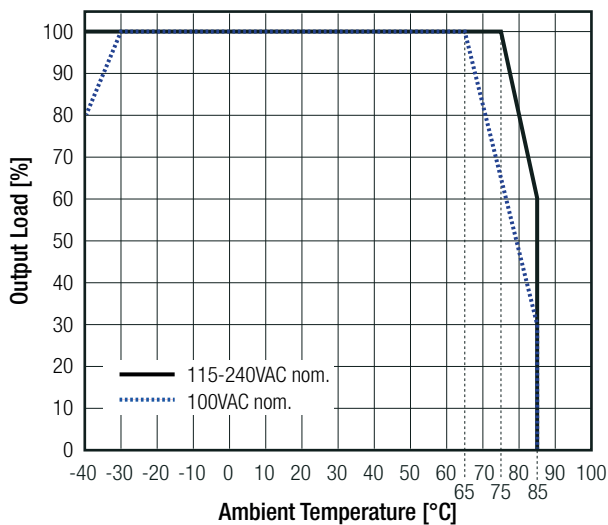

**others**

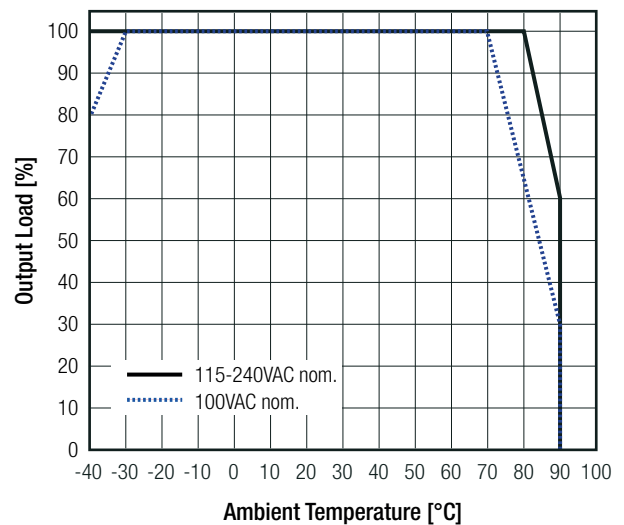

**Notes:**

Note7: Output power derating for Line-input of less than 90VAC (de-rate linearly from 100% at 90VAC to 85% at 85VAC)  
For 61558-2-16 considerations refer to 100VAC nom. ratings

**Specifications** (measured @ Ta= 25°C, nom. Vin, full load and after warm-up unless otherwise stated)

<b>SAFETY AND CERTIFICATION</b>		
<b>Certificate Type (Safety)</b>	<b>Report Number</b>	<b>Standard</b>
Audio/Video, information and communication technology equipment - Part 1: Safety requirements	E491408-A6014-UL	UL62368-1:2019 3rd Edition CAN/CSA-C22.2 No. 62368-1:2019
Audio/Video, information and communication technology equipment - Safety requirements (CB Scheme)	200703001-1	IEC62368-1:2018 3rd Edition
Audio/Video, information and communication technology equipment - Safety requirements		EN IEC 62368-1:2020+A11:2020
Audio/Video, information and communication technology equipment - Safety requirements (LVD)	200703001-3	EN62368-1:2014+A11:2017
Safety of power transformers, power supplies, reactors and similar products for supply voltages up to 1100 V (CB Scheme)	60394453 001	IEC61558-1:2005 2nd Edition + A1:2009
Safety of power transformers, power supplies, reactors and similar products for supply voltages up to 1100 V		EN61558-1:2005 + A1:2009
Safety of power transformers, power supplies, reactors and similar products for supply voltages up to 1100 V Part 2: Particular requirements (CB Scheme)		IEC61558-2-16:2009 1st Edition + A1:2013
Safety of power transformers, power supplies, reactors and similar products for supply voltages up to 1100 V Part 2: Particular requirements		EN61558-2-16:2009 + A1:2013
Household and similar electrical appliances – Safety – Part 1: General requirements	pending	EN IEC60335-1
RoHS2		RoHS 2011/65/EU + AM2015/863
<b>EMC Compliance (according to EN55032/35)</b>	<b>Condition</b>	<b>Standard / Criterion</b>
Electromagnetic compatibility of multimedia equipment – Emission Requirements		EN55032:2015, Class B
Electromagnetic compatibility of multimedia equipment – Immunity requirements		EN55035:2017
ESD Electrostatic discharge immunity test	Air: ±2, 4, 8kV; Contact: ±4kV	IEC61000-4-2:2008 , Criteria A EN61000-4-2:2009, Criteria A
Radiated, radio-frequency, electromagnetic field immunity test	3V/m: 80-1000MHz, 1800MHz, 2600MHz, 3500MHz, 5000MHz	IEC/EN61000-4-3:2006 + A2:2010, Criteria A
Fast Transient and Burst Immunity	AC Port: ±1kV	IEC/EN61000-4-4:2012, Criteria A
Surge Immunity	AC Port: ±0.5, 1kV	IEC/EN61000-4-5:2014, Criteria A
Immunity to conducted disturbances, induced by radio-frequency fields	3Vrms: 0.15-10MHz 3-1Vrms: 10-30MHz 1Vrms: 30-80MHz	IEC61000-4-6:2013. Criteria A EN6100-4-6:2014, Criteria A
Voltage Dips	100% & 30%	IEC/EN61004-11:2004, Criteria A
Voltage Interruptions	>95%	IEC/EN61004-11:2004, Criteria A
Limits of Harmonic Current Emissions		EN IEC 61000-3-2:2019
Limits of Voltage Fluctuations & Flicker	Clause 5	EN61000-3-3:2013+A1
Limitations on the amount of electromagnetic interference allowed from digital and electronic devices		FCC 47 CFR Part 15 Subpart B, Class B
<b>EMC Compliance (according to EN55014-1 and EN55014-2)</b>	<b>Condition</b>	<b>Standard / Criterion</b>
Electromagnetic compatibility of multimedia equipment – Emission Requirements		EN55014-1:2017
Information technology equipment - Immunity characteristics - Limits and methods of measurement		EN55014-2:2015
ESD Electrostatic discharge immunity test	Air: ±8kV; Contact: ±4kV	IEC61000-4-2:2008 , Criteria A EN61000-4-2:2009, Criteria A
Fast Transient and Burst Immunity	AC Port: ±1kV	IEC/EN61000-4-4:2012, Criteria A
Surge Immunity	AC Port: ±0.5, 1kV	IEC/EN61000-4-5:2014, Criteria A
Immunity to conducted disturbances, induced by radio-frequency fields	3Vrms: 0.15-230MHz	IEC61000-4-6:2013. Criteria A EN6100-4-6:2014, Criteria A
Voltage Dips	100% & 60%	IEC/EN61004-11:2004, Criteria A
Voltage Interruptions	>95%	IEC/EN61004-11:2004, Criteria A

continued on next page

**Specifications** (measured @ Ta= 25°C, nom. Vin, full load and after warm-up unless otherwise stated)

EMC Compliance (according to EN61204-3)	Condition	Standard / Criterion
Low voltage power supplies, d.c. output Part 3: Electromagnetic compatibility		EN IEC 61204-3:2018
ESD Electrostatic discharge immunity test	Air: ±8kV Contact: ±4kV	IEC61000-4-2:2008 , Criteria A EN61000-4-2:2009, Criteria A
Radiated, radio-frequency, electromagnetic field immunity test	3V/m: 80-1000MHz; 1400-2000MHz 1V/m: 2000-2700MHz	IEC/EN61000-4-3:2006 + A2:2010, Criteria A
Fast Transient and Burst Immunity	AC Port: ±1kV	IEC/EN61000-4-4:2012, Criteria A
Surge Immunity	AC Port: ±0.5, 1kV	IEC/EN61000-4-5:2014, Criteria A
Immunity to conducted disturbances, induced by radio-frequency fields	3Vrms: 0.15-80MHz	IEC61000-4-6:2013. Criteria A EN6100-4-6:2014, Criteria A
Voltage Dips	100%, 60%, 30%	IEC/EN61004-11:2004, Criteria A
Voltage Interruptions	>95%	IEC/EN61004-11:2004, Criteria A

**DIMENSION AND PHYSICAL CHARACTERISTICS**

Parameter	Type	Value
Material	case/baseplate potting PCB	black plastic, (UL94 V-0) silicone, (UL94 V-0) FR4, (UL94 V-0)
Dimension (LxWxH)		33.7 x 22.2 x 15.4mm
Weight		18.4g typ.

**Dimension Drawing (mm)**

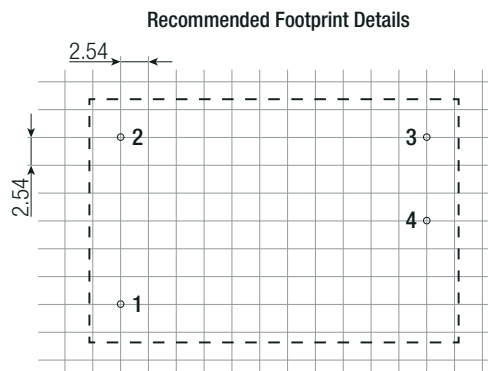
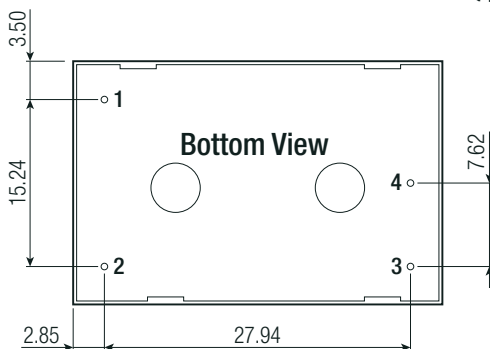
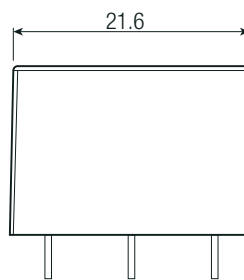
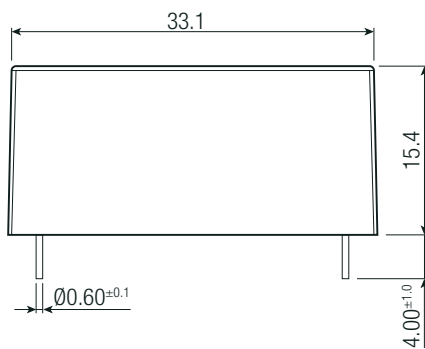
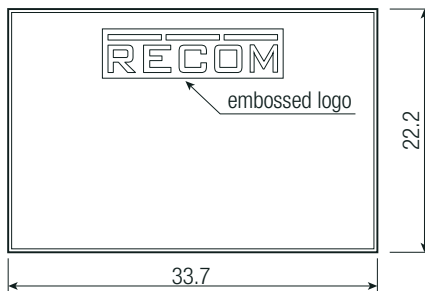

**General tolerances according to ISO 2768-m**  
(table for reference only)

Dimension range	Tolerances
0.5 - 6 mm	±0.1 mm
6 - 30 mm	±0.2 mm
30 - 120 mm	±0.3 mm
120 - 400 mm	±0.5 mm

**Pinning Information**

Pin #	Single
1	VAC in (L)
2	VAC in (N)
3	-Vout
4	+Vout

**Specifications** (measured @ Ta= 25°C, nom. Vin, full load and after warm-up unless otherwise stated)

**PACKAGING INFORMATION**

Parameter	Type	Value
Packaging Dimension (LxWxH)	tube	490.0 x 36.3 x 26.3mm
Packaging Quantity		20pcs
Storage Temperature Range		-40°C to +85°C
Storage Humidity	non-condensing	95% RH max.