

## CLQ6B-TKW: PLCC8 4-in-1 RGBW SMD LEDs

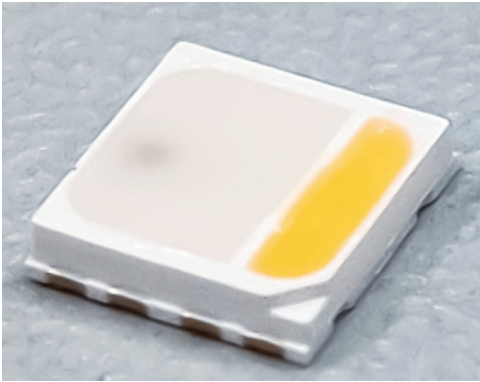

### PRODUCT DESCRIPTION

These SMD LEDs are packaged in an industry standard PLCC8 package. These high performance 4 color SMT LEDs are designed to work in a wide range of applications. A wide viewing angle and high brightness make these LEDs suitable for signage applications.

### FEATURES

- Size (mm): 5.0 x 5.2 x 1.1
- Dominant Wavelength/CCT
  - Red (619 - 624nm)
  - Green (520 - 535nm)
  - Blue (460 - 475nm)
  - White(3000K/4000K/5000K/5700K)
- Lead - Free
- RoHS Compliant

### APPLICATIONS

- Architecture Lighting
- Decorative Lighting
- Amusement

**ABSOLUTE MAXIMUM RATINGS ( $T_A = 25^\circ\text{C}$ )**

| Items  | Symbol     | Absolute Maximum Rating |     |     |     | Unit                      |
|--|------------|-------------------------|-----|-----|-----|---------------------------|
|  |            | R                       | G   | B   | W   |                           |
| Forward Current <sup>Note 1</sup>                    | $I_F$      | 200                     | 180 | 180 | 200 | mA                        |
| Peak Forward Current <sup>Note 2</sup>               | $I_{FP}$   | 500                     | 400 | 400 | 500 | mA                        |
| Reverse Voltage                                      | $V_R$      | 5                       | 5   | 5   | 5   | V                         |
| Power Dissipation                                    | $P_D$      | 520                     | 684 | 684 | 720 | mW                        |
| Operation Temperature                                | $T_{opr}$  | -40 ~ +85               |     |     |     | $^\circ\text{C}$          |
| Storage Temperature                                  | $T_{stg}$  | -40 ~ +100              |     |     |     | $^\circ\text{C}$          |
| Junction Temperature                                 | $T_J$      | 110                     | 110 | 110 | 110 | $^\circ\text{C}$          |
| Junction/ambient                                     | $R_{THJA}$ | 60                      | 110 | 70  | 80  | $^\circ\text{C}/\text{W}$ |
| Junction/solder point                                | $R_{THJS}$ | 20                      | 70  | 40  | 40  | $^\circ\text{C}/\text{W}$ |
| Electrostatic Discharge Classification(MIL-STD-883E) | ESD        | 1000 V                  |     |     |     |                           |

**Note:**

1. Single color light
2. Pulse width  $\leq 0.1$  msec, duty  $\leq 1/10$ .

**TYPICAL ELECTRICAL & OPTICAL CHARACTERISTICS ( $T_A = 25^\circ\text{C}$ )**

| Characteristics                         | Condition  | Symbol           | Values  |         |         |       | Unit          |
|---|--|------------------|---------|---------|---------|-------|---------------|
|   |  |                  | R       | G       | B       | W     |               |
| Dominant Wavelength                     | $I_F = 100$ mA(R)<br>$I_F = 100$ mA(G)<br>$I_F = 100$ mA(B)<br>$I_F = 100$ mA(W) | $\lambda_{DOM}$  | 619~624 | 520~535 | 460~475 | NA    | nm            |
| Spectral bandwidth at 50% $I_{REL}$ max | $I_F = 100$ mA(R)<br>$I_F = 100$ mA(G)<br>$I_F = 100$ mA(B)<br>$I_F = 100$ mA(W) | $\Delta \lambda$ | 24      | 38      | 28      | NA    | nm            |
| Forward Voltage                         | $I_F = 100$ mA(R)<br>$I_F = 100$ mA(G)<br>$I_F = 100$ mA(B)<br>$I_F = 100$ mA(W) | $V_{F(avg)}$     | 2.1     | 3.0     | 3.1     | 2.9   | V             |
|   |  | $V_{F(max)}$     | 2.5     | 3.7     | 3.5     | 3.5   | V             |
| Luminous Intensity                      | $I_F = 100$ mA(R)<br>$I_F = 100$ mA(G)<br>$I_F = 100$ mA(B)<br>$I_F = 100$ mA(W) | $I_{V(min)}$     | 3000    | 7030    | 1824    | 10100 | mcd           |
|   |  | $I_{V(avg)}$     | 4700    | 12000   | 3400    | 15000 | mcd           |
| Luminous Flux(Reference)                | $I_F = 100$ mA(R)<br>$I_F = 100$ mA(G)<br>$I_F = 100$ mA(B)<br>$I_F = 100$ mA(W) | $\Phi_{V(avg)}$  | 14.5    | 32.5    | 9.5     | 43    | lm            |
| Reverse Current (max)                   | $V_R = 5$ V  | $I_R$            | 100     | 100     | 100     | 100   | $\mu\text{A}$ |

\* Continuous reverse voltage can cause LED damage.

## INTENSITY BIN LIMIT

| Red (100 mA) |           |           | Green (100 mA) |           |           | Blue (100 mA) |           |           | White (100 mA) |           |           |
|--------------|-----------|-----------|----------------|-----------|-----------|---------------|-----------|-----------|----------------|-----------|-----------|
| Bin Code     | Min.(mcd) | Max.(mcd) | Bin Code       | Min.(mcd) | Max.(mcd) | Bin Code      | Min.(mcd) | Max.(mcd) | Bin Code       | Min.(mcd) | Max.(mcd) |
| 1L           | 3000      | 4180      | 1R             | 7030      | 10100     | 1H            | 1824      | 2560      | 1T             | 10100     | 14400     |
| 1M           | 3590      | 5020      | 1S             | 8200      | 12000     | 1J            | 2130      | 3000      | 1U             | 12000     | 16800     |
| 1N           | 4180      | 5860      | 1T             | 10100     | 14400     | 1K            | 2560      | 3590      | 1V             | 14400     | 20160     |
|              |           |           |                |           |           | 1L            | 3000      | 4180      |                |           |           |

\* Tolerance of measurement of luminous intensity is  $\pm 10\%$

## COLOR BIN LIMIT

| Red (100 mA) |          |          | Green (100 mA) |          |          | Blue (100 mA) |          |          |
|--------------|----------|----------|----------------|----------|----------|---------------|----------|----------|
| Bin Code     | Min.(nm) | Max.(nm) | Bin Code       | Min.(nm) | Max.(nm) | Bin Code      | Min.(nm) | Max.(nm) |
| RB           | 619      | 624      | G7             | 520      | 525      | B3            | 460      | 465      |
|              |          |          | G23            | 522.5    | 527.5    | B23           | 462.5    | 467.5    |
|              |          |          | G8             | 525      | 530      | B4            | 465      | 470      |
|              |          |          | G45            | 527.5    | 532.5    | B45           | 467.5    | 472.5    |
|              |          |          | G9             | 530      | 535      | B5            | 470      | 475      |

\* Tolerance of measurement of dominant wavelength is  $\pm 1$  nm.

## CRI BIN LIMIT

| White (100 mA) |          |          |
|----------------|----------|----------|
| Bin Code       | CRI Min. | CRI Max. |
| D              | 75       | 80       |
| H              | 80       | 85       |
| J              | 85       | 90       |

\* Tolerance of measurement of CRI is  $\pm 2$ .

COLOR BIN LIMIT

White (100 mA)

- Tolerance of measurement of the color coordinates is  $\pm 0.01$ .

| Bin Code | Sub-bins | x      | y      |
|----------|----------|--------|--------|
| XA       | A11      | 0.3146 | 0.3172 |
|          |          | 0.3201 | 0.3222 |
|          |          | 0.3211 | 0.3106 |
|          |          | 0.3161 | 0.3059 |
|          | A12      | 0.3130 | 0.3284 |
|          |          | 0.3190 | 0.3339 |
|          |          | 0.3201 | 0.3222 |
|          |          | 0.3146 | 0.3172 |
|          | A13      | 0.3190 | 0.3339 |
|          |          | 0.3251 | 0.3394 |
|          |          | 0.3256 | 0.3273 |
|          |          | 0.3201 | 0.3222 |
|          | A14      | 0.3201 | 0.3222 |
|          |          | 0.3256 | 0.3273 |
|          |          | 0.3261 | 0.3152 |
|          |          | 0.3211 | 0.3106 |
|          | A21      | 0.3115 | 0.3397 |
|          |          | 0.3180 | 0.3456 |
|          |          | 0.3190 | 0.3339 |
|          |          | 0.3130 | 0.3284 |
|          | A22      | 0.3099 | 0.3509 |
|          |          | 0.3170 | 0.3572 |
|          |          | 0.3180 | 0.3456 |
|          |          | 0.3115 | 0.3397 |
|          | A23      | 0.3170 | 0.3572 |
|          |          | 0.3240 | 0.3636 |
|          |          | 0.3245 | 0.3515 |
|          |          | 0.3180 | 0.3456 |
| A24      | 0.3180   | 0.3456 |        |
|          | 0.3245   | 0.3515 |        |
|          | 0.3251   | 0.3394 |        |
|          | 0.3190   | 0.3339 |        |

| Bin Code | Sub-bins | x      | y      |
|----------|----------|--------|--------|
| XA       | A31      | 0.3245 | 0.3515 |
|          |          | 0.3311 | 0.3574 |
|          |          | 0.3311 | 0.3449 |
|          |          | 0.3251 | 0.3394 |
|          | A32      | 0.3240 | 0.3636 |
|          |          | 0.3311 | 0.3699 |
|          |          | 0.3311 | 0.3574 |
|          |          | 0.3245 | 0.3515 |
|          | A33      | 0.3311 | 0.3699 |
|          |          | 0.3381 | 0.3762 |
|          |          | 0.3376 | 0.3633 |
|          |          | 0.3311 | 0.3574 |
|          | A34      | 0.3311 | 0.3574 |
|          |          | 0.3376 | 0.3633 |
|          |          | 0.3371 | 0.3504 |
|          |          | 0.3311 | 0.3449 |
|          | A41      | 0.3256 | 0.3273 |
|          |          | 0.3311 | 0.3324 |
|          |          | 0.3311 | 0.3199 |
|          |          | 0.3261 | 0.3152 |
|          | A42      | 0.3251 | 0.3394 |
|          |          | 0.3311 | 0.3449 |
|          |          | 0.3311 | 0.3324 |
|          |          | 0.3256 | 0.3273 |
|          | A43      | 0.3311 | 0.3449 |
|          |          | 0.3371 | 0.3504 |
|          |          | 0.3366 | 0.3374 |
|          |          | 0.3311 | 0.3324 |
| A44      | 0.3311   | 0.3324 |        |
|          | 0.3366   | 0.3374 |        |
|          | 0.3361   | 0.3245 |        |
|          | 0.3311   | 0.3199 |        |

| Bin Code | Sub-bins | x      | y      |
|----------|----------|--------|--------|
| XD       | D11      | 0.3371 | 0.3504 |
|          |          | 0.3433 | 0.3546 |
|          |          | 0.3423 | 0.3413 |
|          |          | 0.3366 | 0.3374 |
|          | D12      | 0.3376 | 0.3633 |
|          |          | 0.3443 | 0.3678 |
|          |          | 0.3433 | 0.3546 |
|          |          | 0.3371 | 0.3504 |
|          | D13      | 0.3443 | 0.3678 |
|          |          | 0.3509 | 0.3724 |
|          |          | 0.3494 | 0.3588 |
|          |          | 0.3433 | 0.3546 |
|          | D14      | 0.3433 | 0.3546 |
|          |          | 0.3494 | 0.3588 |
|          |          | 0.3479 | 0.3453 |
|          |          | 0.3423 | 0.3413 |
|          | D21      | 0.3381 | 0.3762 |
|          |          | 0.3453 | 0.3811 |
|          |          | 0.3443 | 0.3678 |
|          |          | 0.3376 | 0.3633 |
|          | D22      | 0.3386 | 0.3891 |
|          |          | 0.3463 | 0.3944 |
|          |          | 0.3453 | 0.3811 |
|          |          | 0.3381 | 0.3762 |
|          | D23      | 0.3463 | 0.3944 |
|          |          | 0.3541 | 0.3996 |
|          |          | 0.3525 | 0.3860 |
|          |          | 0.3453 | 0.3811 |
| D24      | 0.3453   | 0.3811 |        |
|          | 0.3525   | 0.3860 |        |
|          | 0.3509   | 0.3724 |        |
|          | 0.3443   | 0.3678 |        |

| Bin Code | Sub-bins | x      | y      |
|----------|----------|--------|--------|
| XD       | D31      | 0.3525 | 0.3860 |
|          |          | 0.3596 | 0.3908 |
|          |          | 0.3576 | 0.3769 |
|          |          | 0.3509 | 0.3724 |
|          | D32      | 0.3541 | 0.3996 |
|          |          | 0.3616 | 0.4047 |
|          |          | 0.3596 | 0.3908 |
|          |          | 0.3525 | 0.3860 |
|          | D33      | 0.3616 | 0.4047 |
|          |          | 0.3693 | 0.4099 |
|          |          | 0.3668 | 0.3957 |
|          |          | 0.3596 | 0.3908 |
|          | D34      | 0.3596 | 0.3908 |
|          |          | 0.3668 | 0.3957 |
|          |          | 0.3643 | 0.3815 |
|          |          | 0.3576 | 0.3769 |
|          | D41      | 0.3494 | 0.3588 |
|          |          | 0.3556 | 0.3631 |
|          |          | 0.3536 | 0.3492 |
|          |          | 0.3479 | 0.3453 |
|          | D42      | 0.3509 | 0.3724 |
|          |          | 0.3576 | 0.3769 |
|          |          | 0.3556 | 0.3631 |
|          |          | 0.3494 | 0.3588 |
|          | D43      | 0.3576 | 0.3769 |
|          |          | 0.3643 | 0.3815 |
|          |          | 0.3618 | 0.3673 |
|          |          | 0.3556 | 0.3631 |
| D44      | 0.3556   | 0.3631 |        |
|          | 0.3618   | 0.3673 |        |
|          | 0.3592   | 0.3531 |        |
|          | 0.3536   | 0.3492 |        |

## COLOR BIN LIMIT

### White (100 mA)

- Tolerance of measurement of the color coordinates is  $\pm 0.01$ .

| Bin Code | Sub-bins | x      | y      |
|----------|----------|--------|--------|
| SB       | 4C3      | 0.3663 | 0.3758 |
|          |          | 0.3680 | 0.3833 |
|          |          | 0.3736 | 0.3874 |
|          |          | 0.3719 | 0.3797 |
|          | 4C4      | 0.3646 | 0.368  |
|          |          | 0.3663 | 0.3758 |
|          |          | 0.3719 | 0.3797 |
|          |          | 0.3702 | 0.3722 |
|          | 4D3      | 0.3630 | 0.3611 |
|          |          | 0.3646 | 0.368  |
|          |          | 0.3702 | 0.3722 |
|          |          | 0.3686 | 0.3649 |
|          | 4D4      | 0.3614 | 0.3539 |
|          |          | 0.3630 | 0.3611 |
|          |          | 0.3686 | 0.3649 |
|          |          | 0.3670 | 0.3578 |
|          | 4T4      | 0.3680 | 0.3833 |
|          |          | 0.3698 | 0.3915 |
|          |          | 0.3754 | 0.3954 |
|          |          | 0.3736 | 0.3874 |
|          | 5S1      | 0.3736 | 0.3874 |
|          |          | 0.3754 | 0.3954 |
|          |          | 0.3820 | 0.3997 |
|          |          | 0.3802 | 0.3916 |
|          | 5S4      | 0.3802 | 0.3916 |
|          |          | 0.3820 | 0.3997 |
|          |          | 0.3894 | 0.4044 |
|          |          | 0.3871 | 0.3959 |
| 5T1      | 0.3871   | 0.3959 |        |
|          | 0.3894   | 0.4044 |        |
|          | 0.3962   | 0.4086 |        |
|          | 0.3937   | 0.4001 |        |
| 5T4      | 0.3937   | 0.4001 |        |
|          | 0.3962   | 0.4086 |        |
|          | 0.4035   | 0.4133 |        |
|          | 0.4006   | 0.4044 |        |

| Bin Code | Sub-bins | x      | y      |
|----------|----------|--------|--------|
| SB       | 5A1      | 0.3670 | 0.3578 |
|          |          | 0.3686 | 0.3649 |
|          |          | 0.3744 | 0.3685 |
|          |          | 0.3726 | 0.3612 |
|          | 5A2      | 0.3686 | 0.3649 |
|          |          | 0.3702 | 0.3722 |
|          |          | 0.3763 | 0.3760 |
|          |          | 0.3744 | 0.3685 |
|          | 5A3      | 0.3744 | 0.3685 |
|          |          | 0.3763 | 0.3760 |
|          |          | 0.3825 | 0.3798 |
|          |          | 0.3804 | 0.3721 |
|          | 5A4      | 0.3726 | 0.3612 |
|          |          | 0.3744 | 0.3685 |
|          |          | 0.3804 | 0.3721 |
|          |          | 0.3783 | 0.3646 |
|          | 5B1      | 0.3702 | 0.3722 |
|          |          | 0.3719 | 0.3797 |
|          |          | 0.3782 | 0.3837 |
|          |          | 0.3763 | 0.3760 |
|          | 5B2      | 0.3719 | 0.3797 |
|          |          | 0.3736 | 0.3874 |
|          |          | 0.3802 | 0.3916 |
|          |          | 0.3782 | 0.3837 |
|          | 5B3      | 0.3782 | 0.3837 |
|          |          | 0.3802 | 0.3916 |
|          |          | 0.3869 | 0.3958 |
|          |          | 0.3847 | 0.3877 |
| 5B4      | 0.3763   | 0.3760 |        |
|          | 0.3782   | 0.3837 |        |
|          | 0.3847   | 0.3877 |        |
|          | 0.3825   | 0.3798 |        |

| Bin Code | Sub-bins | x      | y      |
|----------|----------|--------|--------|
| SB       | 5C1      | 0.3825 | 0.3798 |
|          |          | 0.3847 | 0.3877 |
|          |          | 0.3912 | 0.3917 |
|          |          | 0.3887 | 0.3836 |
|          | 5C2      | 0.3847 | 0.3877 |
|          |          | 0.3869 | 0.3958 |
|          |          | 0.3937 | 0.4001 |
|          |          | 0.3912 | 0.3917 |
|          | 5C3      | 0.3912 | 0.3917 |
|          |          | 0.3937 | 0.4001 |
|          |          | 0.4006 | 0.4044 |
|          |          | 0.3978 | 0.3958 |
|          | 5C4      | 0.3887 | 0.3836 |
|          |          | 0.3912 | 0.3917 |
|          |          | 0.3978 | 0.3958 |
|          |          | 0.3950 | 0.3875 |
|          | 5D1      | 0.3783 | 0.3646 |
|          |          | 0.3804 | 0.3721 |
|          |          | 0.3863 | 0.3758 |
|          |          | 0.3840 | 0.3681 |
|          | 5D2      | 0.3804 | 0.3721 |
|          |          | 0.3825 | 0.3798 |
|          |          | 0.3887 | 0.3836 |
|          |          | 0.3863 | 0.3758 |
|          | 5D3      | 0.3863 | 0.3758 |
|          |          | 0.3887 | 0.3836 |
|          |          | 0.3950 | 0.3875 |
|          |          | 0.3924 | 0.3794 |
| 5D4      | 0.3840   | 0.3681 |        |
|          | 0.3863   | 0.3758 |        |
|          | 0.3924   | 0.3794 |        |
|          | 0.3898   | 0.3716 |        |

## COLOR BIN LIMIT

### White (100 mA)

- Tolerance of measurement of the color coordinates is  $\pm 0.01$ .

| Bin Code | Sub-bins | x      | y      |
|----------|----------|--------|--------|
| SC       | 6C3      | 0.4186 | 0.4037 |
|          |          | 0.4222 | 0.4127 |
|          |          | 0.4299 | 0.4165 |
|          |          | 0.4259 | 0.4073 |
|          | 6C4      | 0.4150 | 0.3950 |
|          |          | 0.4186 | 0.4037 |
|          |          | 0.4259 | 0.4073 |
|          |          | 0.4221 | 0.3984 |
|          | 6D3      | 0.4116 | 0.3865 |
|          |          | 0.4150 | 0.3950 |
|          |          | 0.4221 | 0.3984 |
|          |          | 0.4183 | 0.3898 |
|          | 6D4      | 0.4082 | 0.3782 |
|          |          | 0.4116 | 0.3865 |
|          |          | 0.4183 | 0.3898 |
|          |          | 0.4147 | 0.3814 |
|          | 6T4      | 0.4222 | 0.4127 |
|          |          | 0.4265 | 0.4220 |
|          |          | 0.4340 | 0.4260 |
|          |          | 0.4299 | 0.4165 |
|          | 7S1      | 0.4299 | 0.4165 |
|          |          | 0.4340 | 0.4260 |
|          |          | 0.4406 | 0.4284 |
|          |          | 0.4364 | 0.4188 |
|          | 7S4      | 0.4364 | 0.4188 |
|          |          | 0.4406 | 0.4284 |
|          |          | 0.4477 | 0.4310 |
|          |          | 0.4430 | 0.4212 |
| 7T1      | 0.4430   | 0.4212 |        |
|          | 0.4477   | 0.4310 |        |
|          | 0.4543   | 0.4334 |        |
|          | 0.4496   | 0.4236 |        |
| 7T4      | 0.4496   | 0.4236 |        |
|          | 0.4543   | 0.4334 |        |
|          | 0.4614   | 0.4360 |        |
|          | 0.4562   | 0.4260 |        |

| Bin Code | Sub-bins | x      | y      |
|----------|----------|--------|--------|
| SC       | 7A1      | 0.4147 | 0.3814 |
|          |          | 0.4183 | 0.3898 |
|          |          | 0.4242 | 0.3919 |
|          |          | 0.4203 | 0.3833 |
|          | 7A2      | 0.4183 | 0.3898 |
|          |          | 0.4221 | 0.3984 |
|          |          | 0.4281 | 0.4006 |
|          |          | 0.4242 | 0.3919 |
|          | 7A3      | 0.4242 | 0.3919 |
|          |          | 0.4281 | 0.4006 |
|          |          | 0.4342 | 0.4028 |
|          |          | 0.4300 | 0.3939 |
|          | 7A4      | 0.4203 | 0.3833 |
|          |          | 0.4242 | 0.3919 |
|          |          | 0.4300 | 0.3939 |
|          |          | 0.4259 | 0.3853 |
|          | 7B1      | 0.4221 | 0.3984 |
|          |          | 0.4259 | 0.4073 |
|          |          | 0.4322 | 0.4096 |
|          |          | 0.4281 | 0.4006 |
|          | 7B2      | 0.4259 | 0.4073 |
|          |          | 0.4299 | 0.4165 |
|          |          | 0.4364 | 0.4188 |
|          |          | 0.4322 | 0.4096 |
|          | 7B3      | 0.4322 | 0.4096 |
|          |          | 0.4364 | 0.4188 |
|          |          | 0.4430 | 0.4212 |
|          |          | 0.4385 | 0.4119 |
| 7B4      | 0.4281   | 0.4006 |        |
|          | 0.4322   | 0.4096 |        |
|          | 0.4385   | 0.4119 |        |
|          | 0.4342   | 0.4028 |        |

| Bin Code | Sub-bins | x      | y      |
|----------|----------|--------|--------|
| SC       | 7C1      | 0.4342 | 0.4028 |
|          |          | 0.4385 | 0.4119 |
|          |          | 0.4449 | 0.4141 |
|          |          | 0.4403 | 0.4049 |
|          | 7C2      | 0.4385 | 0.4119 |
|          |          | 0.4430 | 0.4212 |
|          |          | 0.4496 | 0.4236 |
|          |          | 0.4449 | 0.4141 |
|          | 7C3      | 0.4449 | 0.4141 |
|          |          | 0.4496 | 0.4236 |
|          |          | 0.4562 | 0.4260 |
|          |          | 0.4513 | 0.4164 |
|          | 7C4      | 0.4403 | 0.4049 |
|          |          | 0.4449 | 0.4141 |
|          |          | 0.4513 | 0.4164 |
|          |          | 0.4465 | 0.4071 |
|          | 7D1      | 0.4259 | 0.3853 |
|          |          | 0.4300 | 0.3939 |
|          |          | 0.4359 | 0.3960 |
|          |          | 0.4316 | 0.3873 |
|          | 7D2      | 0.4300 | 0.3939 |
|          |          | 0.4342 | 0.4028 |
|          |          | 0.4403 | 0.4049 |
|          |          | 0.4359 | 0.3960 |
|          | 7D3      | 0.4359 | 0.3960 |
|          |          | 0.4403 | 0.4049 |
|          |          | 0.4465 | 0.4071 |
|          |          | 0.4418 | 0.3981 |
| 7D4      | 0.4316   | 0.3873 |        |
|          | 0.4359   | 0.3960 |        |
|          | 0.4418   | 0.3981 |        |
|          | 0.4373   | 0.3893 |        |

CIE CHROMATICITY DIAGRAM

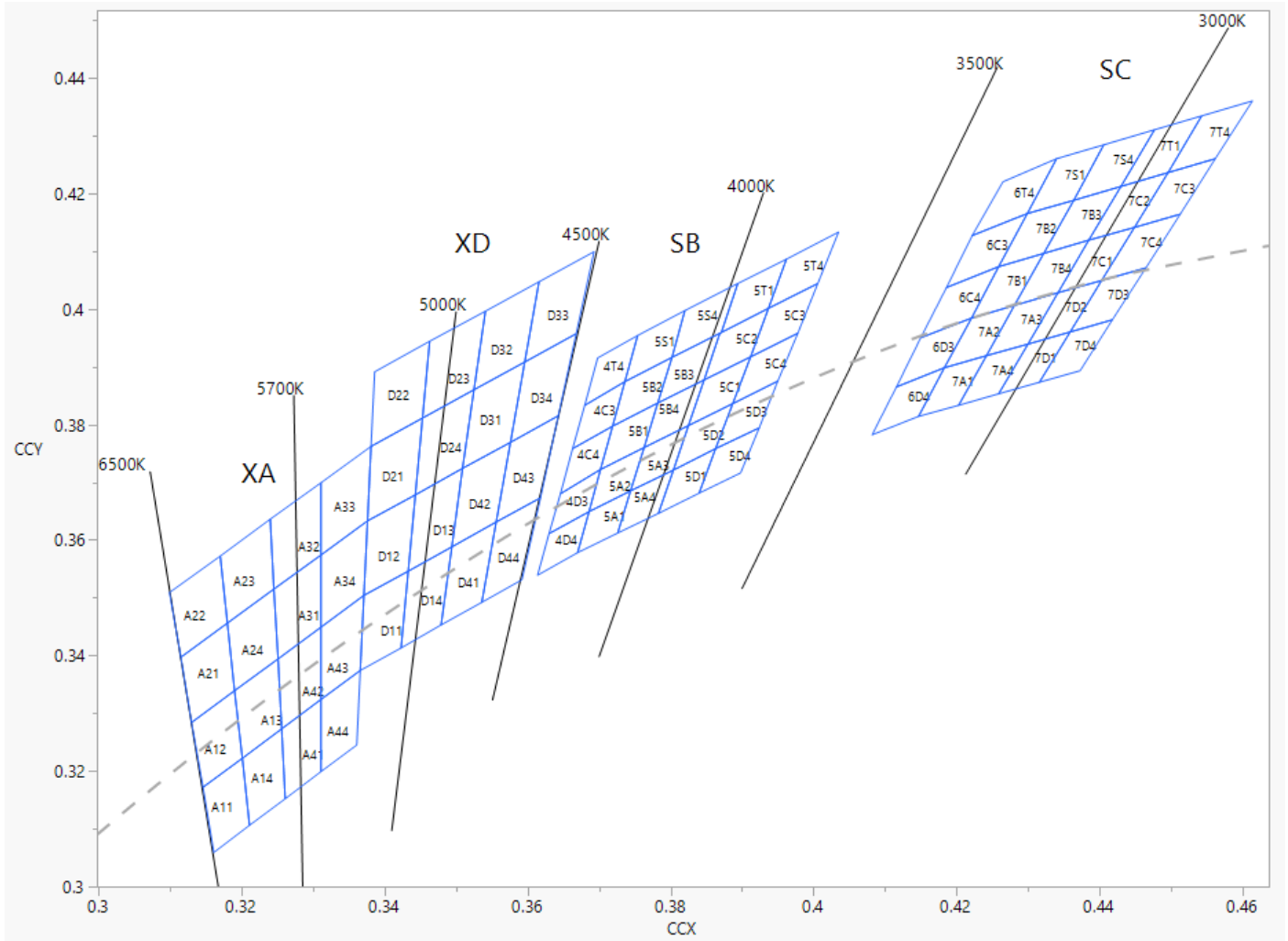

## ORDER CODE TABLE

| Kit Number                   | Color | Luminous Intensity (mcd)                       |      | Dominant Wavelength (nm)             |          |           |          | Package |
|------------------------------|-------|--|------|--------------------------------------|----------|-----------|----------|---------|
|                              |       | Min.   | Max. | Color Bin                            | Min.(nm) | Color Bin | Max.(nm) |         |
| CLQ6B-TKW-S1L1R1H1TBB7935AA3 | Red   | Any 1 Intensity bin from 1L(3000) - 1N(5860)   |      | RB                                   | 619      | RB        | 624      | Reel    |
|                              | Green | Any 1 Intensity bin from 1R(7030) - 1T(14400)  |      | Any 1 hue bin from G7(520) - G9(535) |          |           |          | Reel    |
|                              | Blue  | Any 1 Intensity bin from 1H(1824) - 1L(4180)   |      | Any 1 hue bin from B3(460) - B5(475) |          |           |          | Reel    |
|                              | White | Any 1 Intensity bin from 1T(10100) - 1V(20160) |      | XA                                   |          |           |          | Reel    |
| CLQ6B-TKW-S1L1R1H1TBB7935BB3 | Red   | Any 1 Intensity bin from 1L(3000) - 1N(5860)   |      | RB                                   | 619      | RB        | 624      | Reel    |
|                              | Green | Any 1 Intensity bin from 1R(7030) - 1T(14400)  |      | Any 1 hue bin from G7(520) - G9(535) |          |           |          | Reel    |
|                              | Blue  | Any 1 Intensity bin from 1H(1824) - 1L(4180)   |      | Any 1 hue bin from B3(460) - B5(475) |          |           |          | Reel    |
|                              | White | Any 1 Intensity bin from 1T(10100) - 1V(20160) |      | SB                                   |          |           |          | Reel    |
| CLQ6B-TKW-S1L1R1H1TBB7935CC3 | Red   | Any 1 Intensity bin from 1L(3000) - 1N(5860)   |      | RB                                   | 619      | RB        | 624      | Reel    |
|                              | Green | Any 1 Intensity bin from 1R(7030) - 1T(14400)  |      | Any 1 hue bin from G7(520) - G9(535) |          |           |          | Reel    |
|                              | Blue  | Any 1 Intensity bin from 1H(1824) - 1L(4180)   |      | Any 1 hue bin from B3(460) - B5(475) |          |           |          | Reel    |
|                              | White | Any 1 Intensity bin from 1T(10100) - 1V(20160) |      | SC                                   |          |           |          | Reel    |
| CLQ6B-TKW-S1L1R1H1TBB7935DD3 | Red   | Any 1 Intensity bin from 1L(3000) - 1N(5860)   |      | RB                                   | 619      | RB        | 624      | Reel    |
|                              | Green | Any 1 Intensity bin from 1R(7030) - 1T(14400)  |      | Any 1 hue bin from G7(520) - G9(535) |          |           |          | Reel    |
|                              | Blue  | Any 1 Intensity bin from 1H(1824) - 1L(4180)   |      | Any 1 hue bin from B3(460) - B5(475) |          |           |          | Reel    |
|                              | White | Any 1 Intensity bin from 1T(10100) - 1V(20160) |      | XD                                   |          |           |          | Reel    |

## Notes:

- The above kit numbers represent the order codes which include multiple intensity-bin and color-bin codes. Only one intensity-bin code and one color-bin code will be shipped on each reel. Single intensity-bin code and single color-bin code will be orderable in certain quantities. For example, any 1 intensity bin from 1R - 1T means only 1 intensity bin(1R or 1S or 1T) will be shipped by Cree LED. For example, any 1 color bin from G7 - G9 means only 1 color bin (G7 or G23 or G8 or G45 or G9) will be shipped by Cree LED.
- Please refer to the [HB LED Lamp Reliability Test Standards](#) document for reliability test conditions.
- Please refer to the [HB LED Lamp Soldering & Handling](#) document for information about how to use this LED product safely.



GRAPHS

The data below are collected from statistical figures that do not necessarily correspond to the actual parameters of each single LED. Hence, these data will be changed without further notice.

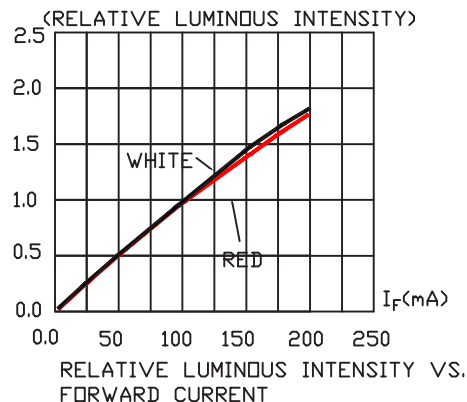
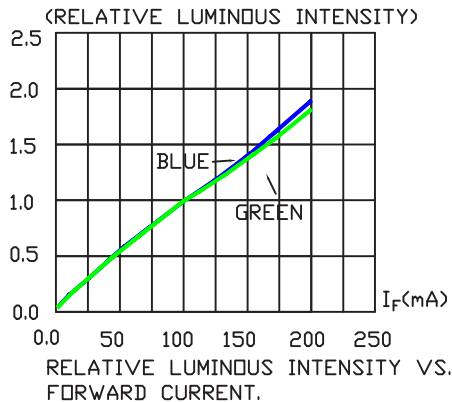
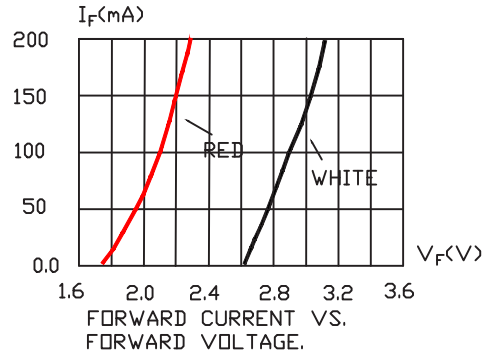
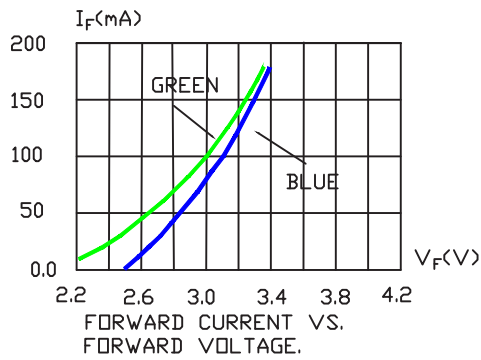
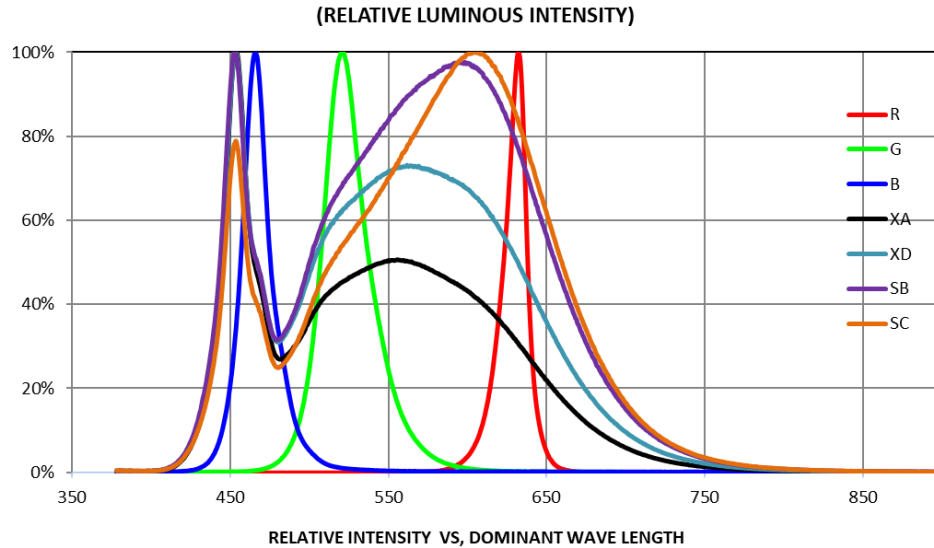

GRAPHS

The data below are collected from statistical figures that do not necessarily correspond to the actual parameters of each single LED. Hence, these data will be changed without further notice.

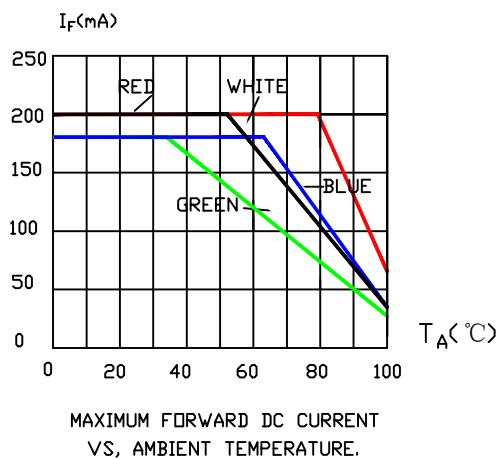
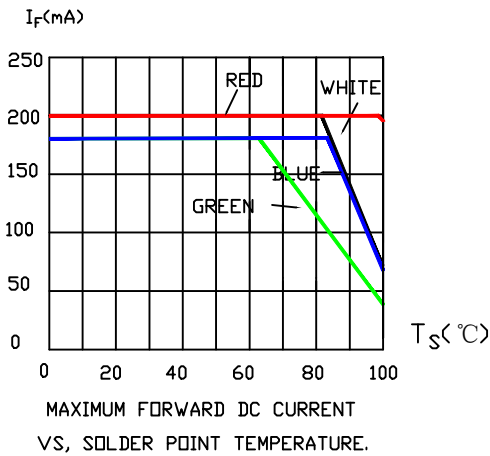
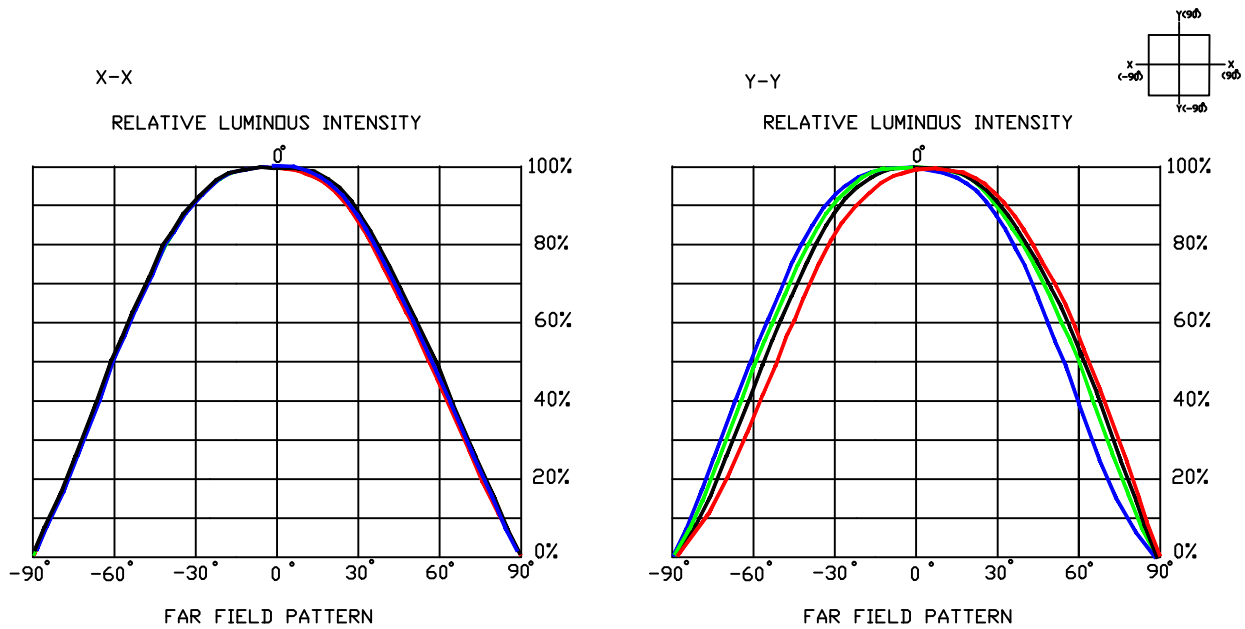

## MECHANICAL DIMENSIONS

All dimensions are in mm. Tolerance of measurement of the dimension is  $\pm 0.1$ .

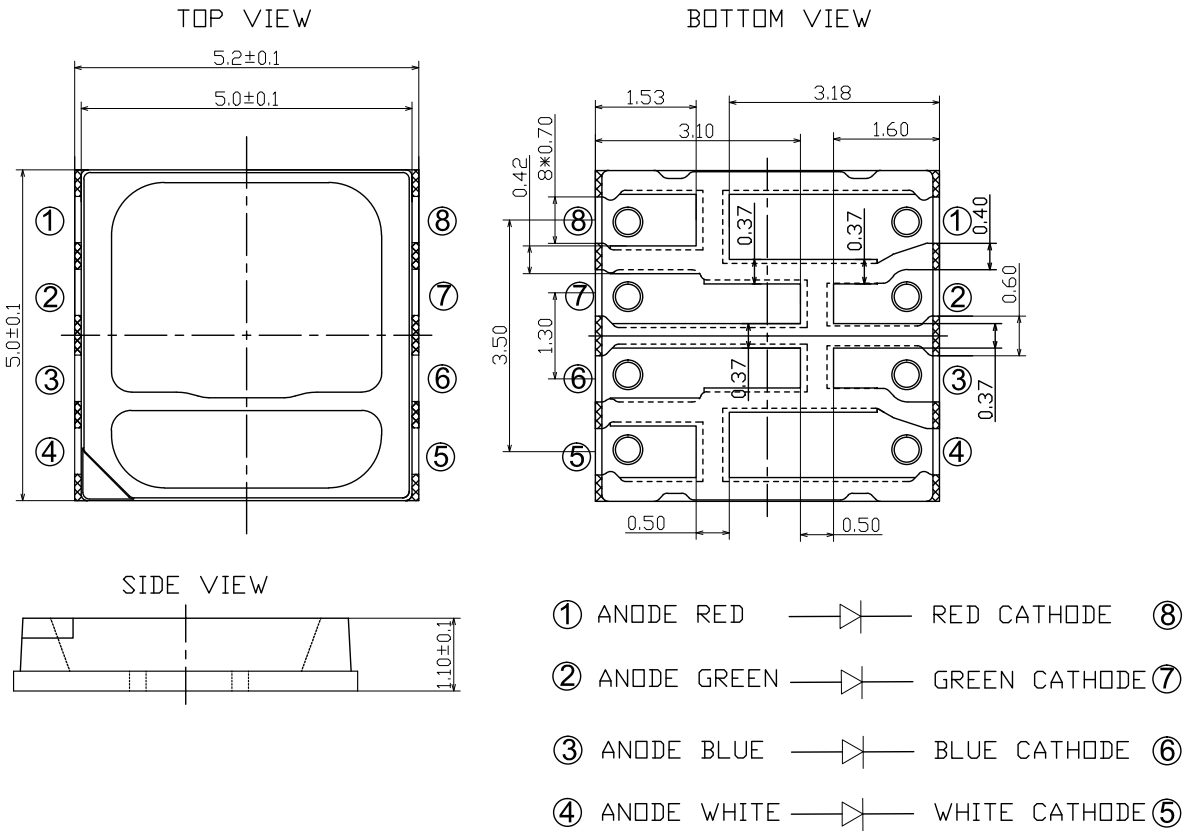

## RECOMMENDED SOLDER PAD DIMENSIONS

All dimensions are in mm. Tolerance of measurement of the dimension is  $\pm 0.1$ .

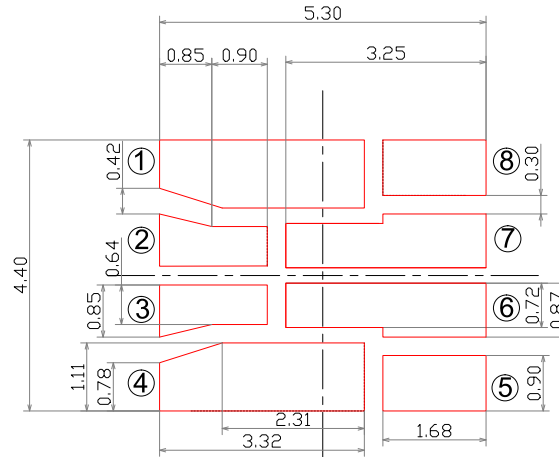

### Assembly Notes

- Modification of an SMD LED is not recommended after soldering. If modification cannot be avoided, the modifications must be pre-qualified to avoid damaging the SMD LED.
- Reflow soldering should not be done more than two times (according to model's MSL requirements).
- No stress should be exerted on the package during soldering.
- The package may be affected by environments & assemblies which contain corrosive substance. Please avoid conditions which may cause the LEDs to corrode tarnish or discolor.
- The PCB should not be wrapped after soldering to allow natural cooling down to 40°C.

## KIT NUMBER SYSTEM

Cree LED lamps are tested and sorted into performance bins. A bin is specified by ranges of color, forward voltage, and brightness. Sorted LEDs are packaged for shipping in various convenient options.

Cree LEDs are sold by order codes in combinations of bins called kits. Order codes are configured in the following manner:

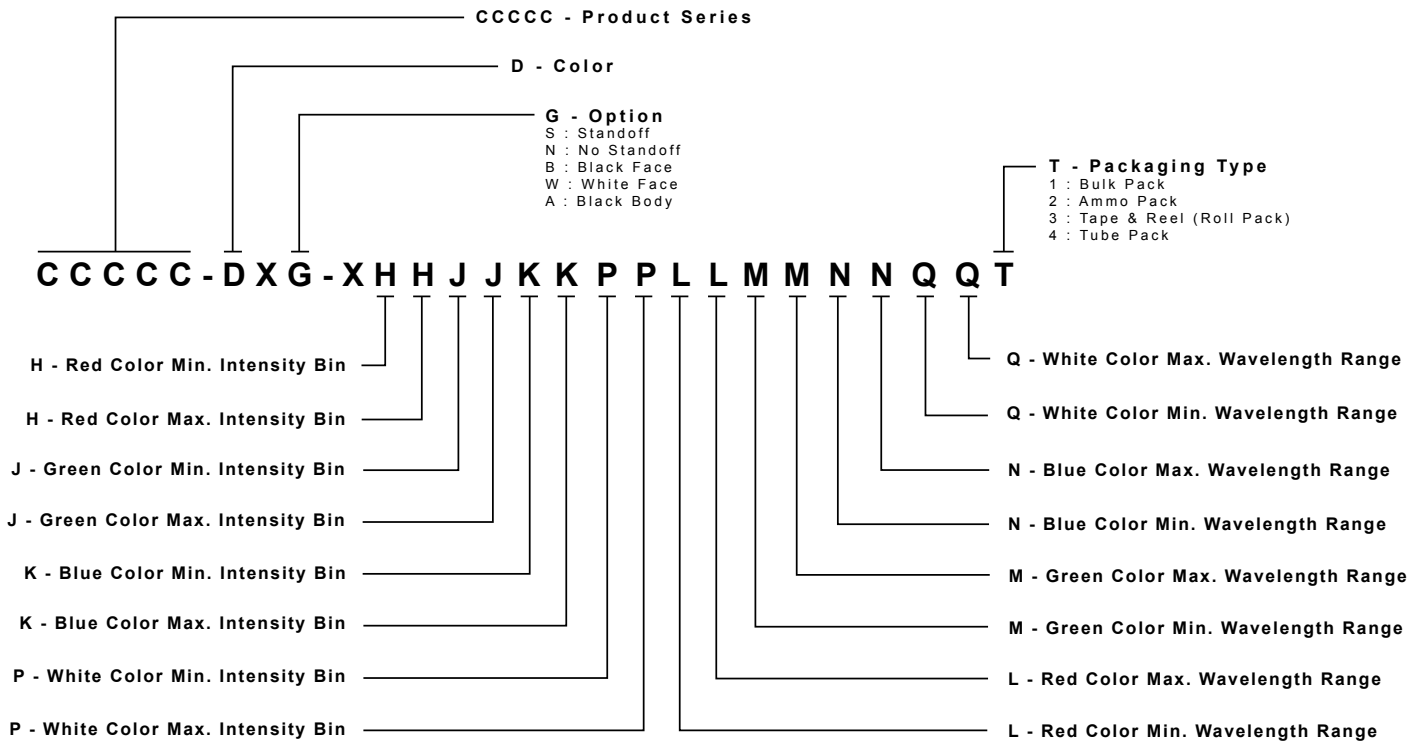

## REFLOW SOLDERING

- The CLQ6B-TKW is rated as a MSL 5a product.
- The recommended floor life out of bag is 24hrs.
- The temperature profile is as below.

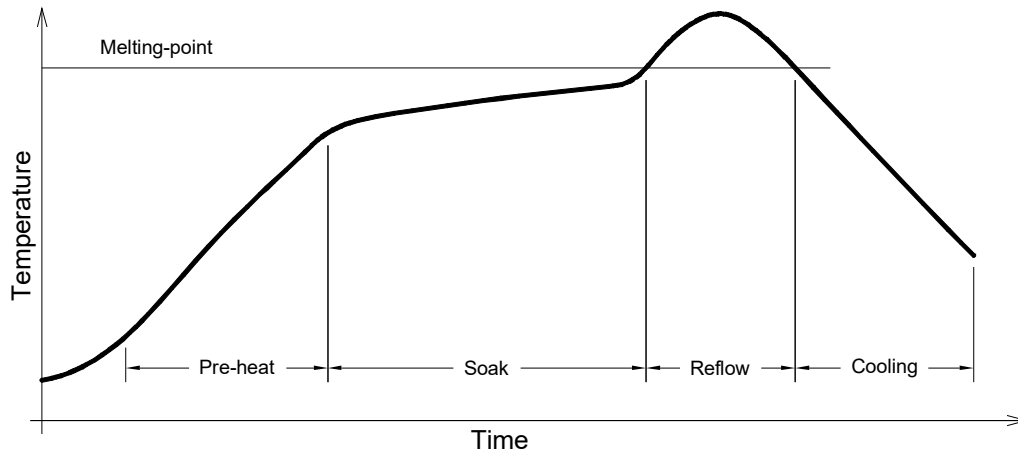

Use only with CLQ6B-TKW

| Solder   |
|--|
| Average ramp-up rate = 4 °C/second max.                |
| Soak temperature = 150°C-200°C                         |
| Soak time = 120 seconds max.                           |
| Duration above 217 °C = 60 seconds max.                |
| Peak temperature = 250°C max                           |
| Time within 5 °C of peak temperature = 10 seconds max. |
| Ramp-down rate = 6 °C/second max.                      |

- The packaging sizes of these SMD products are very small and the resin is still soft after solidification. Users are required to handle with care. Never touch the resin surface of SMD products.
- To avoid damaging the product's surface and interior device, it is recommended to choose a special nozzle to pick up the SMD products during the process of SMT production. If handling is necessary, take special care when picking up these products. The following method is necessary:
- Please refer to the [HB LED Lamp Soldering & Handling](#) document for information about how to use this LED product safely.

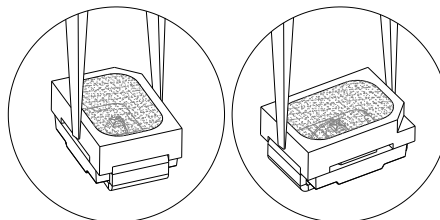

PACKAGING

- The LEDs are packed in cardboard boxes after packaging in normal or anti-electrostatic bags.
- Cardboard boxes will be used to protect the LEDs from mechanical shock during transportation.
- The boxes are not water resistant, and they must be kept away from water and moisture.
- The reel pack is applied in SMD LED.
- Max 4000 pcs per reel.

