

SPECIFICATIONS **CLY30B2T**

OUTLINES DIMENSIONS

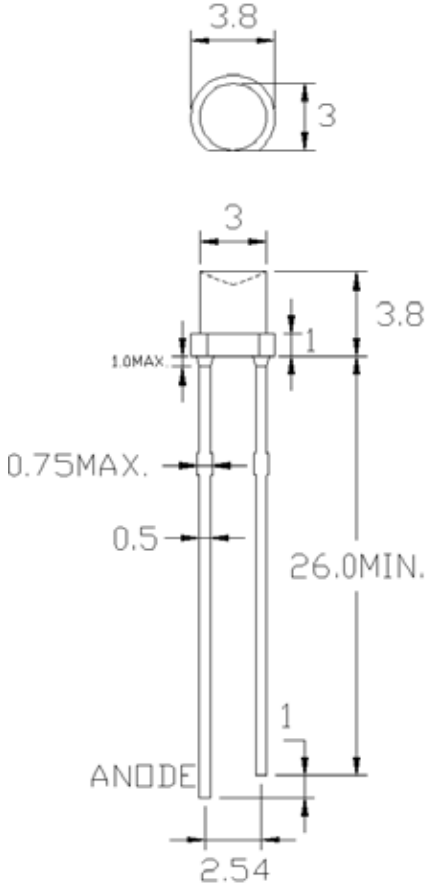

- Notes:
1. All Dimensions are in millimeters (inches).
 2. Tolerance is $\pm 0.25\text{mm}$ (0.01") unless otherwise noted.
 3. Specifications are subject to change without notice.

Part Number	Chip Material	Color of Emission	Lens Type	Viewing Angle
CLY30B2T	InGaN	Blue	Blue Tinted	140°



ChromeLED Corp. reserves the right to make changes at any time in order to supply the best product possible. The most current version of this document will always be available at: www.chromeled.com

ABSOLUTE MAXIMUM RATINGS
(TA=25°C)

Parameter	Symbol	Max Rating	Unit
Power Dissipation	PD	85	mW
Pulse Current Forward Current	IFP	100	mA
Continuous Forward Current	IF	20	mA
Reverse Voltage	VR	5	V
Operating Temperature Range	TOPR	-40~+85	°C
Storage Temperature Range	TSTG	-40~+100	°C
IFP = Pulse Width ≤ 10 ms, Duty Ratio ≤1/10. Soldering Condition: 260 °C/ 5sec			

OPTICAL-ELECTRICAL CHARACTERISTICS
(TA=25°C)

Parameter	Symbol	Test Condition	Value			Unit
			Min	Typ	Max	
Luminous Intensity	IV	IF = 20mA	60	100	-	mcd
Forward Voltage	VF	IF = 20mA	-	3.1	3.5	V
Reverse Leakage Current	IR	VR = 5V	-	-	10	μA
Viewing Angle	2θ1/2	IF = 20mA	-	140	-	deg
Dominant Wavelength	λD	IF = 20mA	-	467	-	nm

*Tolerance of viewing angle: -10 / +5 deg.



ChromeLED Corp. reserves the right to make changes at any time in order to supply the best product possible. The most current version of this document will always be available at: www.chromeled.com

OPTICAL CHARACTERISTIC CURVES

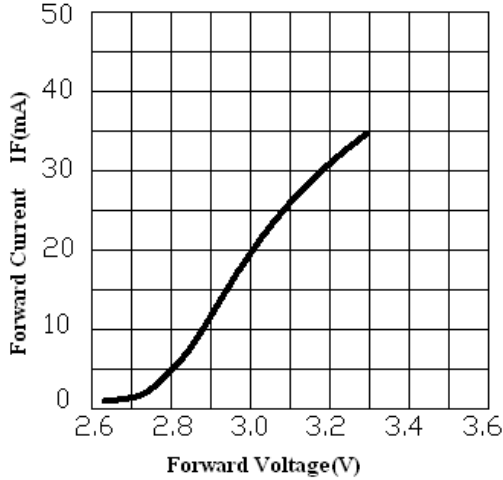

Forward Current vs. Forward Voltage

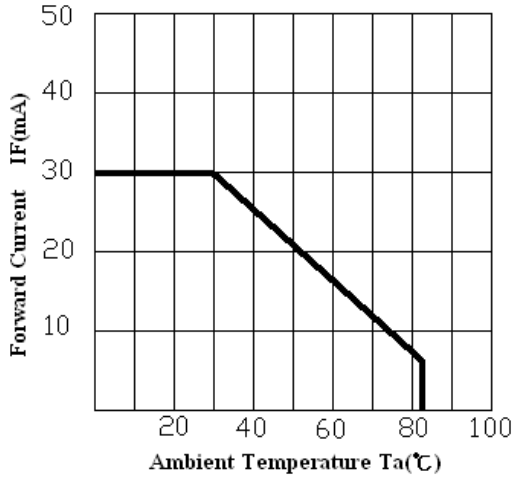

Forward Current Derating Curve

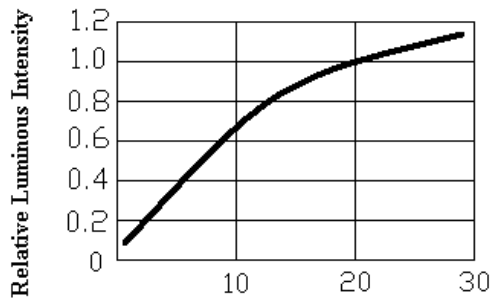

Forward current (mA) Ta=25°C
Luminous Intensity vs. Forward current

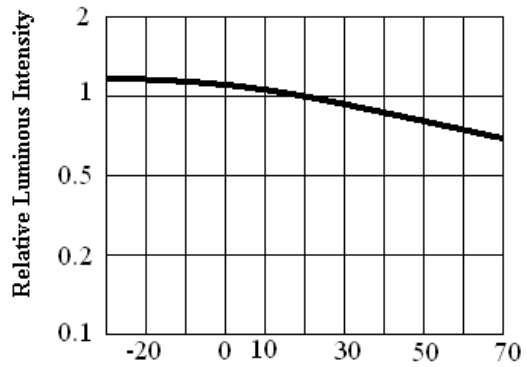

Ambient Temperature Ta= °C
Luminous Intensity vs. Ambient Temperature

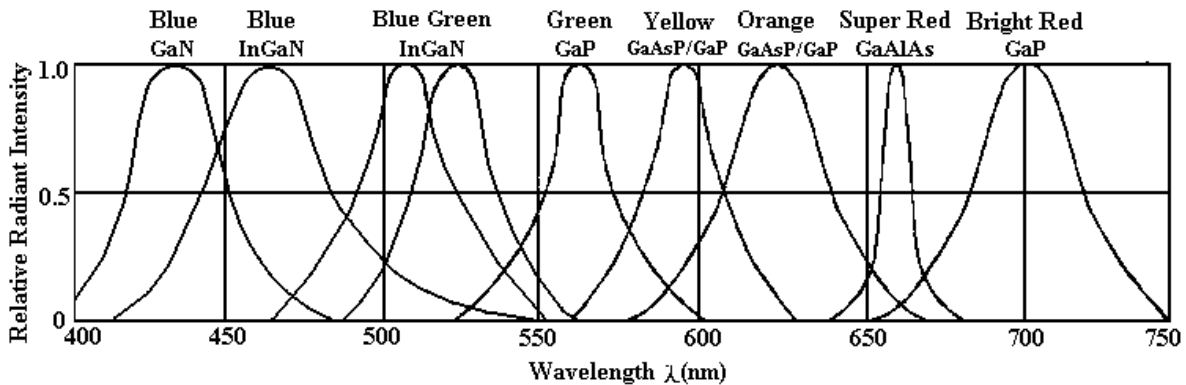

RELATIVE INTENSITY VS. WAVELENGTH



ChromeLED Corp. reserves the right to make changes at any time in order to supply the best product possible. The most current version of this document will always be available at: www.chromeled.com

SOLDERING CONDITIONS – LAMP TYPE LED
1. Soldering Conditions

Number of reflow process shall be less than 2 times and cooling process to normal temperature is required between first and second soldering process.

Recommended Soldering Conditions

Reflow Soldering			Hand Soldering	
	Lead Solder	Lead-Free Solder	Temperature	350°C max
Pre-heat	140~160°C	180~200°C	Soldering Time	3 sec. max. one time only
Pre-heat time	120 sec. max	120 sec. max		
Peak Temp.	230°C max	260°C max		
Soldering Time	10 sec. max	10 sec. max		
Condition	See below	See below		

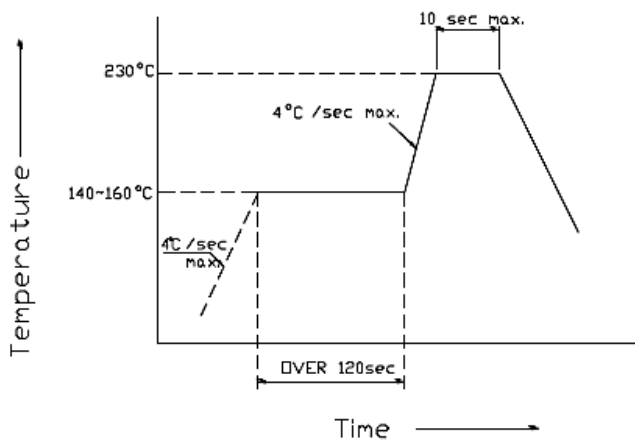
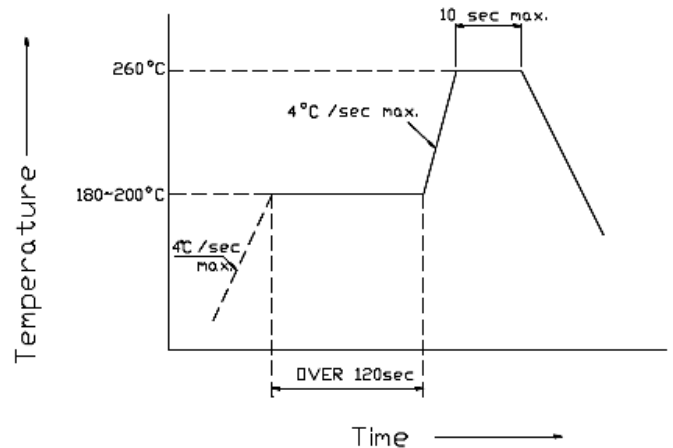
(Lead Solder)

(Lead-Free Solder)

2. Static Electricity

It is recommended that a wrist band or an anti-electrostatic glove be used when handling LEDs. All devices, equipment and machinery must be properly grounded.

Damaged LED will show some unusual characteristics such as the forward voltage becomes lower, or the LEDs do not light at the low current. Criteria: $V_F > 2.0V @ I_F = 0.5mA$.



ChromeLED Corp. reserves the right to make changes at any time in order to supply the best product possible. The most current version of this document will always be available at: www.chromeled.com