

PT5402



Pressure transmitter

PT-100-SEG14-A-ZVG/US/ IW

When selecting an alternative article and accessories please note that technical data may differ!

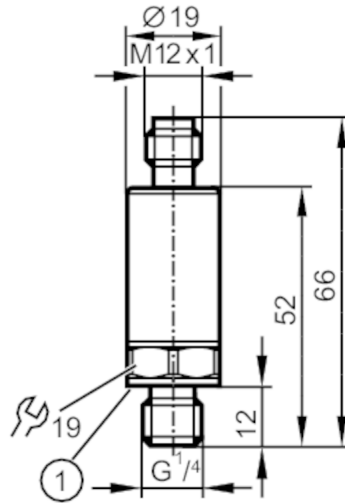

1 Sealing



Product characteristics

Number of inputs and outputs	Number of analogue outputs: 1		
Measuring range	0...100 bar	0...1450 psi	0...10 MPa
Process connection	threaded connection G 1/4 external thread (DIN EN ISO 1179-2)		

Application

Application	for industrial applications		
Media	liquids and gases		
Medium temperature [°C]	-40...90		
Min. bursting pressure	1000 bar	14500 psi	100 MPa
Pressure rating	250 bar	3625 psi	25 MPa
Note on pressure rating	static		
Vacuum resistance [mbar]	-1000		
Type of pressure	relative pressure		

Electrical data

Operating voltage [V]	8.5...36 DC		
Min. insulation resistance [MΩ]	100; (500 V DC)		
Protection class	III		
Reverse polarity protection	yes		
Power-on delay time [s]	< 0.1		

Inputs / outputs

Number of inputs and outputs	Number of analogue outputs: 1		
------------------------------	-------------------------------	--	--

Outputs

Total number of outputs	1		
Output signal	analogue signal		
Number of analogue outputs	1		
Analogue current output [mA]	4...20		

PT5402



Pressure transmitter

PT-100-SEG14-A-ZVG/US/ IW

Max. load	[Ω]	$(U_b - 8,5 \text{ V}) / 21,5 \text{ mA}$; @8,5V = 0 Ω; @12V max. 160 Ω; @24V max. 720 Ω
Short-circuit proof		yes
Overload protection		yes

Measuring/setting range

Measuring range	0...100 bar	0...1450 psi	0...10 MPa
-----------------	-------------	--------------	------------

Accuracy / deviations

Repeatability	[% of the span]	$< \pm 0,05$; (with temperature fluctuations $< 10 \text{ K}$)
Characteristics deviation	[% of the span]	$< \pm 0,5$; (incl. drift when overtightened, zero point and span error, non-linearity, hysteresis)
Linearity deviation	[% of the span]	$< \pm 0,1$ (BFSL) / $< \pm 0,2$ (LS)
Hysteresis deviation	[% of the span]	$< \pm 0,2$
Long-term stability	[% of the span]	$< \pm 0,1$; (per 6 months)
Temperature coefficient zero point and span	[% of the span / 10 K]	$< 0,1$ ($-25...90 \text{ °C}$) / $< 0,2$ ($-40...-25 \text{ °C}$)

Response times

Step response time analogue output	[ms]	1
------------------------------------	------	---

Operating conditions

Ambient temperature	[°C]	-40...90
Storage temperature	[°C]	-40...100
Protection		IP 67; IP 69K

Tests / approvals

EMC	DIN EN 61000-6-2	
	DIN EN 61000-6-3	
Shock resistance	DIN EN 60068-2-27	50 g (11 ms)
Vibration resistance	DIN EN 60068-2-6	20 g (10...2000 Hz)
MTTF	[years]	686
Pressure Equipment Directive		Sound engineering practice; can be used for group 2 fluids; group 1 fluids on request

Mechanical data

Weight	[g]	59
Materials		1.4542 (17-4 PH / 630); stainless steel (1.4404 / 316L); PEI
Materials (wetted parts)		1.4542 (17-4 PH / 630)
Min. pressure cycles		60 million; (at 1.2 times nominal pressure)
Tightening torque	[Nm]	25...35; (recommended tightening torque; depends on lubrication, seal and pressure rating)
Process connection		threaded connection G 1/4 external thread (DIN EN ISO 1179-2)
Process connection sealing		FKM (DIN EN ISO 1179-2)
Restrictor element integrated		no (can be retrofitted)

Remarks

Remarks		BFSL = Best Fit Straight Line LS = limit value setting
Pack quantity		1 pcs.

PT5402



Pressure transmitter

PT-100-SEG14-A-ZVG/US/ IW

Electrical connection

Connector: 1 x M12; coding: A



Connection

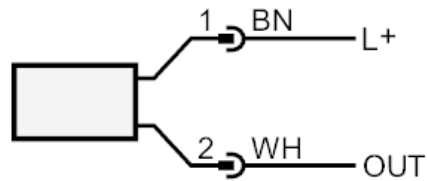

OUT	analogue output The following pin connection is available under article number PT53xx Pin 1: L+, Pin 3: OUT colours to DIN EN 60947-5-2
BN	brown
WH	white