

**PKB4216C Series Fully Regulated DC-DC Converters**  
 Input 36-75 V, Output up to 6.67 A / 200 W

28701-BMR672 Rev.G

Oct 2022

© Flex

### Key Features

- Industry standard low profile Eighth-brick  
58.40 x 22.70 x 8.6 mm (2.30 x 0.89 x 0.34 in)
- High efficiency, typ. 95.7% at 30 Vout full load
- Variable output voltage adjust 15 to 33 Vout
- Open frame intended for conducted cooling (cold wall)
- Optional radio optimized baseplate with GND-pin
- 1500 Vdc input to output isolation
- Meets safety requirements according to IEC/EN/UL 62368-1
- MTBF 3.53 Million hours



### General Characteristics

- Output over voltage protection
- Input under voltage shutdown
- Over temperature protection
- Monotonic start-up
- Pre-bias start up capability
- Output short-circuit protection
- Remote sense
- Remote control
- Highly automated manufacturing ensures quality
- ISO 9001/14001 certified supplier

#### Safety Approvals



#### Design for Environment



Meets requirements in high-temperature lead-free soldering processes.

### Contents

Ordering Information	2
General Information	2
Safety Specification	3
Absolute Maximum Ratings	4
Electrical Specification	
30 V, 6.67 A / 200 W	PKB4216C ..... 5
EMC Specification	9
Operating Information	10
Thermal Consideration	12
Connections	13
Mechanical Information	14
Soldering Information	20
Delivery Information	21
Product Qualification Specification	23

### PKB4216C Series Fully Regulated DC-DC Converters Input 36-75 V, Output up to 6.67 A / 200 W

28701-BMR672 Rev.G

Oct 2022

© Flex

### Ordering Information

Product program	Output
PKB4216C	30 V, 6.67 A / 200 W

### Product number and Packaging

PKB4216C n <sub>1</sub> n <sub>2</sub> n <sub>3</sub> n <sub>4</sub> n <sub>5</sub>					
Options	n <sub>1</sub>	n <sub>2</sub>	n <sub>3</sub>	n <sub>4</sub>	n <sub>5</sub>
Mounting	o				
Remote Control logic		o			
Baseplate			o		
Lead length				o	
Delivery package information					o

### Options Description

Options	Description
n <sub>1</sub>	SI Surface mount PI Through hole
n <sub>2</sub>	Negative * Positive
n <sub>3</sub>	HS Baseplate HV Baseplate with wings HVG Baseplate with wings and GND-pin
n <sub>4</sub>	5.33 mm * LA 3.69 mm (Pin-cut) LB 4.57 mm (Pin-cut) LC 2.79 mm (Pin-cut)
n <sub>5</sub>	/B Tray

Example: a through hole mounted with baseplate, positive logic, 4.57mm pin length 30V product with tray package would be PKB4216CPIPHSLB/B

\* Standard variant (i.e. no option selected).

### General Information

#### Reliability

The failure rate ( $\lambda$ ) and mean time between failures (MTBF =  $1/\lambda$ ) is calculated at max output power and an operating ambient temperature ( $T_A$ ) of +40°C. Flex Power Modules uses Telcordia SR-332 Issue 2 Method 1 to calculate the mean steady-state failure rate and standard deviation ( $\sigma$ ).

Telcordia SR-332 Issue 2 also provides techniques to estimate the upper confidence levels of failure rates based on the mean and standard deviation.

Mean steady-state failure rate,	Std. deviation, $\sigma$
284 nFailures/h	35.4 nFailures/h

MTBF (mean value) for the PKB4216C series = 3.53 Mh.  
MTBF at 90% confidence level = 3.04 Mh

#### Compatibility with RoHS requirements

The products are compatible with the relevant clauses and

requirements of the RoHS directive 2011/65/EU and have a maximum concentration value of 0.1% by weight in homogeneous materials for lead, mercury, hexavalent chromium, PBB and PBDE and of 0.01% by weight in homogeneous materials for cadmium.

Exemptions in the RoHS directive utilized in Flex Power Modules products are found in the Statement of Compliance document.

Flex Power Modules fulfills and will continuously fulfill all its obligations under regulation (EC) No 1907/2006 concerning the registration, evaluation, authorization and restriction of chemicals (REACH) as they enter into force and is through product materials declarations preparing for the obligations to communicate information on substances in the products.

#### Quality Statement

The products are designed and manufactured in an industrial environment where quality systems and methods like ISO 9000, Six Sigma, and SPC are intensively in use to boost the continuous improvements strategy. Infant mortality or early failures in the products are screened out and they are subjected to an ATE-based final test. Conservative design rules, design reviews and product qualifications, plus the high competence of an engaged work force, contribute to the high quality of the products.

#### Warranty

Warranty period and conditions are defined in Flex Power Modules General Terms and Conditions of Sale.

#### Limitation of Liability

Flex Power Modules does not make any other warranties, expressed or implied including any warranty of merchantability or fitness for a particular purpose (including, but not limited to, use in life support applications, where malfunctions of product can cause injury to a person's health or life).

#### © Flex 2022

The information and specifications in this technical specification is believed to be correct at the time of publication. However, no liability is accepted for inaccuracies, printing errors or for any consequences thereof. Flex reserves the right to change the contents of this technical specification at any time without prior notice.

<b>PKB4216C Series Fully Regulated DC-DC Converters</b> Input 36-75 V, Output up to 6.67 A / 200 W	28701-BMR672 Rev.G	Oct 2022
	© Flex	

## Safety Specification

### General information

Flex Power Modules DC/DC converters and DC/DC regulators are designed in accordance with the safety standards IEC 62368-1, EN 62368-1 and UL 62368-1 *Safety of Information Technology Equipment*.

IEC/EN/UL 62368-1 contains requirements to prevent injury or damage due to the following hazards:

- Electrical shock
- Energy hazards
- Fire
- Mechanical and heat hazards
- Radiation hazards
- Chemical hazards

On-board DC/DC converters and DC/DC regulators are defined as component power supplies. As components they cannot fully comply with the provisions of any safety requirements without "conditions of acceptability". Clearance between conductors and between conductive parts of the component power supply and conductors on the board in the final product must meet the applicable safety requirements. Certain conditions of acceptability apply for component power supplies with limited stand-off (see Mechanical Information and Safety Certificate for further information). It is the responsibility of the installer to ensure that the final product housing these components complies with the requirements of all applicable safety standards and regulations for the final product.

Component power supplies for general use should comply with the requirements in IEC/EN/UL 62368-1 *Safety of Information Technology Equipment*. Product related standards, e.g. IEEE 802.3af *Power over Ethernet*, and ETS-300132-2 *Power interface at the input to telecom equipment, operated by direct current (dc)* are based on IEC/EN/UL 62368-1 with regards to safety.

Flex Power Modules DC/DC converters, Power interface modules and DC/DC regulators are UL 62368-1 recognized and certified in accordance with EN 62368-1. The flammability rating for all construction parts of the products meet requirements for V-0 class material according to IEC 60695-11-10, *Fire hazard testing, test flames – 50 W* horizontal and vertical flame test methods.

### Isolated DC/DC converters

The product may provide basic or functional insulation between input and output according to IEC/EN/UL 62368-1 (see Safety Certificate), different conditions shall be met if the output of a basic or a functional insulated product shall be considered as safety extra low voltage (SELV).

For basic insulated products (see Safety Certificate) the output is considered as safety extra low voltage (SELV) if one of the following conditions is met:

- The input source provides supplementary or double or reinforced insulation from the AC mains according to IEC/EN/UL 62368-1.
- The input source provides functional or basic insulation from the AC mains and the product's output is reliably connected to protective earth according to IEC/EN/UL 62368-1.

For functional insulated products (see Safety Certificate) the output is considered as safety extra low voltage (SELV) if one of the following conditions is met:

- The input source provides double or reinforced insulation from the AC mains according to IEC/EN/UL 62368-1.
- The input source provides basic or supplementary insulation from the AC mains and the product's output is reliably connected to protective earth according to IEC/EN/UL 62368-1.
- The input source is reliably connected to protective earth and provides basic or supplementary insulation according to IEC/EN/UL 62368-1 and the maximum input source voltage is 60 Vdc.

Galvanic isolation between input and output is verified in an electric strength test and the isolation voltage ( $V_{iso}$ ) meets the voltage strength requirement for basic insulation according to IEC/EN/UL 62368-1.

It is recommended to use a slow blow fuse at the input of each DC/DC converter. If an input filter is used in the circuit the fuse should be placed in front of the input filter. In the rare event of a component problem that imposes a short circuit on the input source, this fuse will provide the following functions:

- Isolate the fault from the input power source so as not to affect the operation of other parts of the system
- Protect the distribution wiring from excessive current and power loss thus preventing hazardous overheating

**PKB4216C Series Fully Regulated DC-DC Converters**  
 Input 36-75 V, Output up to 6.67 A / 200 W

28701-BMR672 Rev.G

Oct 2022

© Flex

**Absolute Maximum Ratings**

Characteristics		min	typ	max	Unit
T <sub>P1</sub>	Operating Temperature (see Thermal Consideration section)	-40		+125	°C
T <sub>S</sub>	Storage temperature	-55		+125	°C
V <sub>I</sub>	Input voltage	-0.5		+80	V
C <sub>out</sub>	Output capacitance	100			µF
V <sub>iso</sub>	Isolation voltage (input to output test voltage)			1500	Vdc
V <sub>iso</sub>	Isolation voltage (input to baseplate qualification test voltage)			750	Vdc
V <sub>iso</sub>	Isolation voltage (baseplate to output qualification test voltage)			750	Vdc
V <sub>tr</sub>	Input voltage transient according to ETSI EN 300 132-2 and Telcordia GR-1089-CORE			100	V
V <sub>RC</sub>	Remote Control pin voltage (see Operating Information section)	Positive logic option		6	V
		Negative logic option	-0.5	6	V
V <sub>adj</sub>	Adjust pin voltage (see Operating Information section)	-0.5		5	V

Stresses above those listed under Absolute Maximum Ratings may cause permanent damage to the device. This is a stress rating only; functional operation of the device at these or any other conditions above those indicated in the Electrical Specification section of this specification is not implied. Exposure to absolute maximum rating conditions for extended periods may affect device reliability.

**Fundamental Circuit Diagram**

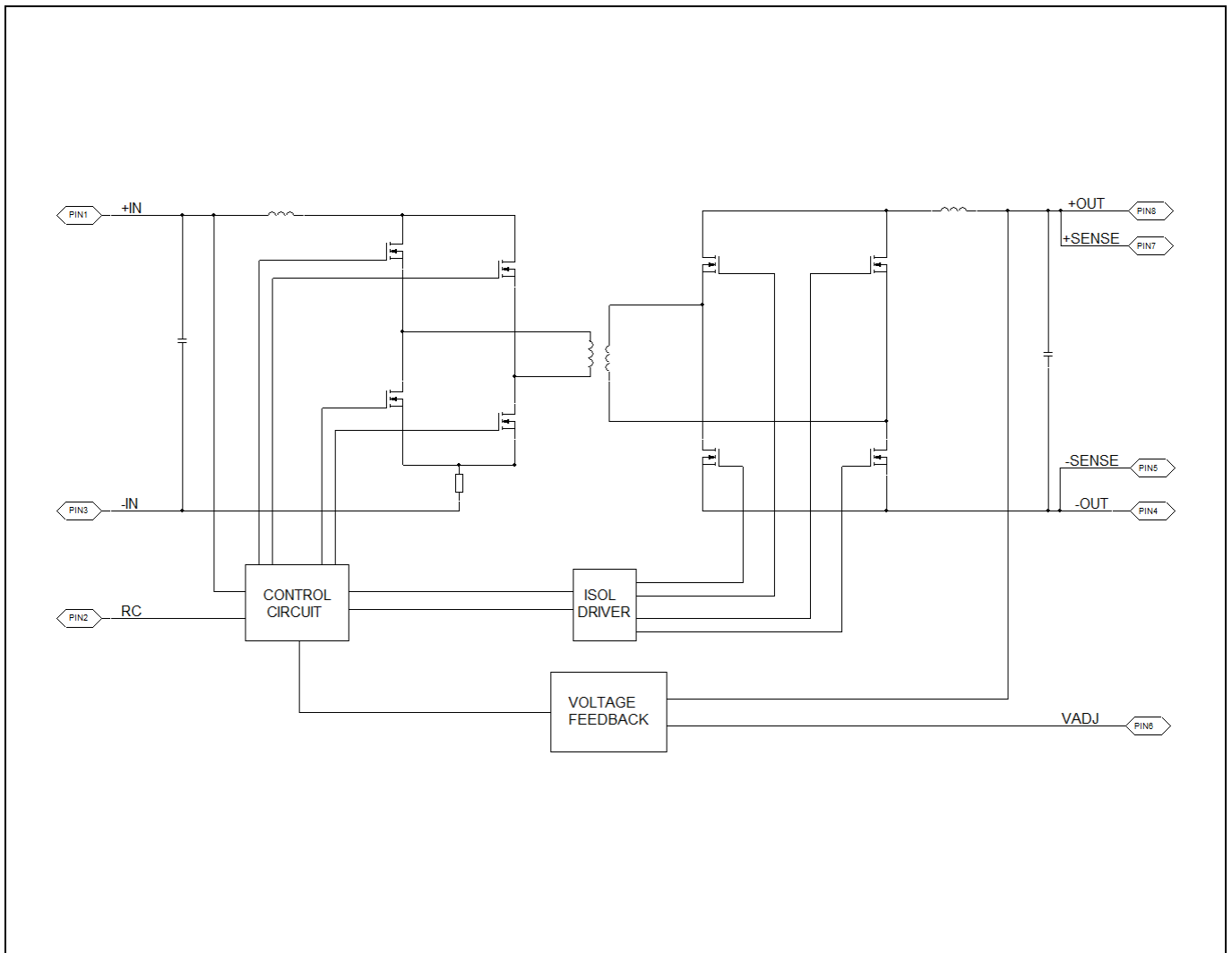

<b>PKB4216C Series Fully Regulated DC-DC Converters</b> Input 36-75 V, Output up to 6.67 A / 200 W	28701-BMR672 Rev.G	Oct 2022
	© Flex	

**Electrical Specification**  
**30 V, 6.7 A / 200 W**

**PKB4216C**

$T_{P1} = -30$  to  $+100^{\circ}\text{C}$ ,  $V_I = 36$  to  $75$  V, unless otherwise specified under Conditions.  
 Typical values given at:  $T_{P1} = +25^{\circ}\text{C}$ ,  $V_I = 48$  V,  $I_O = \text{max}$ , unless otherwise specified under Conditions.  
 Additional  $C_{in} = 100 \mu\text{F}$ ,  $C_{out} = 100\mu\text{F}$ . See Operating Information section for selection of capacitor types.

Characteristics		Conditions	min	typ	max	Unit
$V_I$	Input voltage range		36		75	V
$V_{loff}$	Turn-off input voltage	Decreasing input voltage	31.5	33.0	34.5	V
$V_{lon}$	Turn-on input voltage	Increasing input voltage	33.5	34.8	36	V
$C_I$	Internal input capacitance			9.4		$\mu\text{F}$
$P_O$	Output power		0		200	W
$\eta$	Efficiency	50% of max $I_O$		95.6		%
		max $I_O$		95.7		
		50% of max $I_O$ , $V_I = 53$ V		95.2		
		max $I_O$ , $V_I = 53$ V		95.6		
$P_d$	Power Dissipation	max $I_O$		9.3	13	W
$P_{li}$	Input idling power	$I_O = 0$ A, $V_I = 48$ V		2.9		W
$P_{RC}$	Input standby power	$V_I = 48$ V (turned off with RC)		1.0		W
$f_s$	Switching frequency	0-100 % of max $I_O$	375	400	425	kHz

$V_{Oi}$	Output voltage initial setting and accuracy	$T_{P1} = +25^{\circ}\text{C}$ , $V_I = 48$ V, $I_O = 6.67$ A	29.7	30	30.3	V
$V_O$	Output adjust range	See operating information	15		33	V
	Output voltage tolerance band	0-100% of max $I_O$	29.55		30.45	V
	Idling voltage	$I_O = 0$ A	29.55		30.45	V
	Line regulation	max $I_O$		5	10	mV
	Load regulation	$V_I = 48$ V, 10-100% of max $I_O$		5	15	mV
$V_{tr}$	Load transient voltage deviation	$V_I = 48$ V, Load step 25-75-25% of max $I_O$ , $di/dt = 1$ A/ $\mu\text{s}$ , $C_O = 1.5\text{mF}$		170	250	mV
$t_{tr}$	Load transient recovery time			200	400	$\mu\text{s}$
$t_r$	Ramp-up time (from 10-90% of $V_{Oi}$ )	10-100% of max $I_O$		80	90	ms
$t_s$	Start-up time (from $V_I$ connection to 90% of $V_{Oi}$ )			90	100	ms
$t_f$	$V_I$ shut-down fall time (from $V_I$ off to 10% of $V_O$ )	max $I_O$		1.4		ms
		$I_O = 0$ A		16		s
$t_{RC}$	RC start-up time	max $I_O$		90		ms
	RC shut-down fall time (from RC off to 10% of $V_O$ )	max $I_O$		1.6		ms
		$I_O = 0$ A		16		s
$I_O$	Output current		0		6.7	A
$I_{lim}$	Current limit threshold	$T_{P1} < \text{max } T_{P1}$	8	8.8	10.5	A
$I_{sc}$	Short circuit current	$T_{P1} = 25^{\circ}\text{C}$ , see Note 1		4.1	6	A
$C_{out}$	Recommended Capacitive Load	$T_{P1} = 25^{\circ}\text{C}$ , see Note 2	100		1500	$\mu\text{F}$
$V_{Oac}$	Output ripple & noise	See ripple & noise section, $V_{Oi}$		35	90	mVp-p
OVP	Over voltage protection	$T_{P1} = +25^{\circ}\text{C}$ , $V_I = 48$ V, 0-100% of max $I_O$	38.8	42	43.8	V
RC	Sink current, see Note 3	See operating information	0.5			mA
	Trigger level	Decreasing / Increasing RC-voltage	1.2 / 2.2	1.4 / 2.5	2.5 / 3.8	V

Note 1: RMS current at OCP in hic-up mode

Note 2: Low ESR value

Note 3: Sink current drawn by external device connected to the RC pin.

**PKB4216C Series Fully Regulated DC-DC Converters**  
 Input 36-75 V, Output up to 6.67 A / 200 W

28701-BMR672 Rev.G

Oct 2022

© Flex

**Typical Characteristics**  
**30.0 V, 6.7 A / 200 W**

**PKB4216C**

**Efficiency**

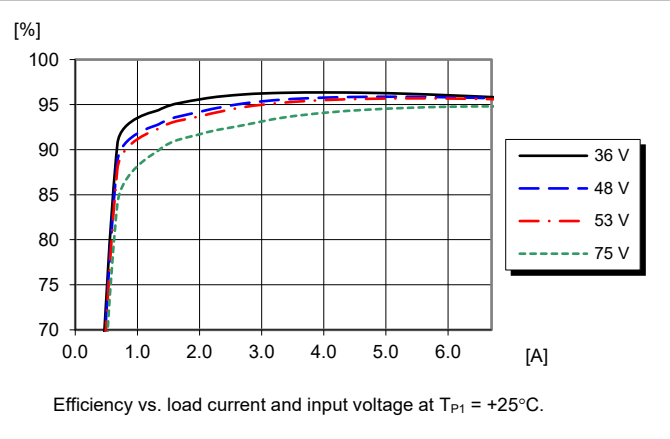

**Power Dissipation**

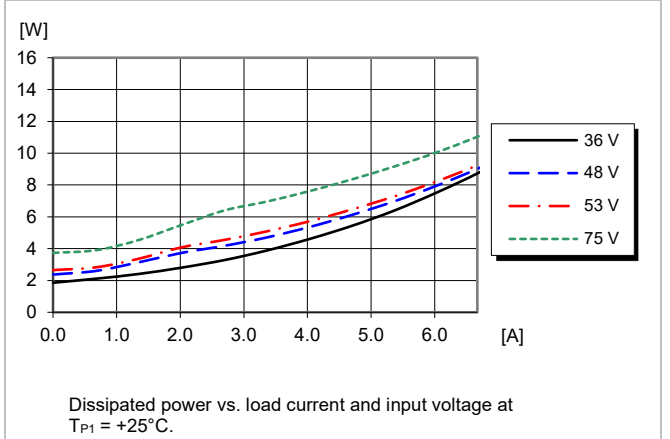

**Output Characteristics**

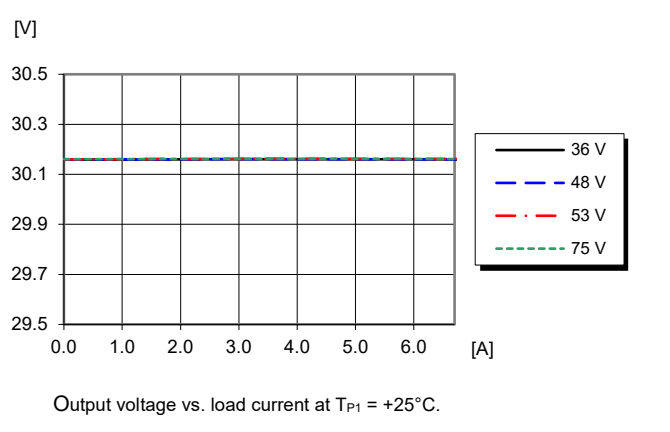

**Current Limit Characteristics**

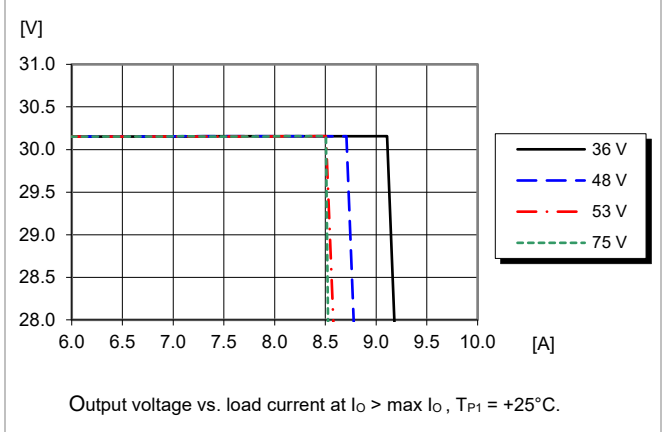

**Maximum start-up current vs. Output capacitance**

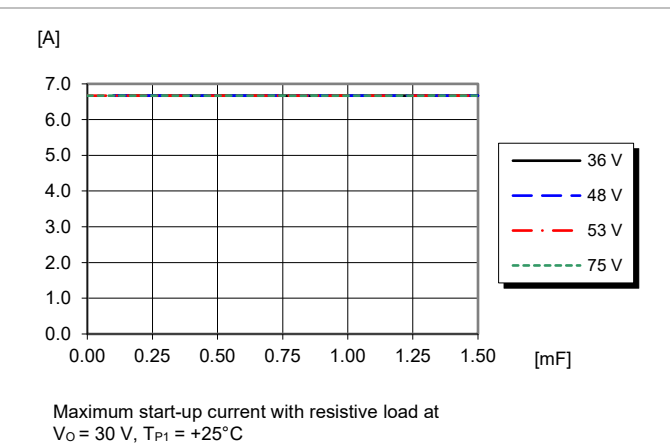

**PKB4216C Series Fully Regulated DC-DC Converters**  
 Input 36-75 V, Output up to 6.67 A / 200 W

28701-BMR672 Rev.G

Oct 2022

© Flex

### Typical Characteristics

**30.0 V, 6.7 A / 200 W**

**PKB4216C**

#### Start-up

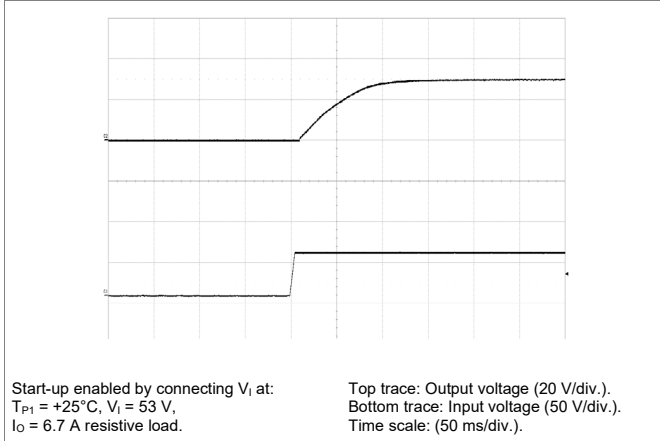

#### Shut-down

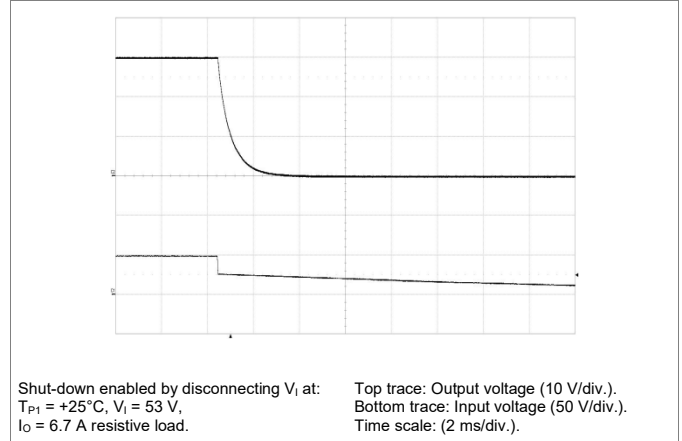

#### Output Ripple & Noise

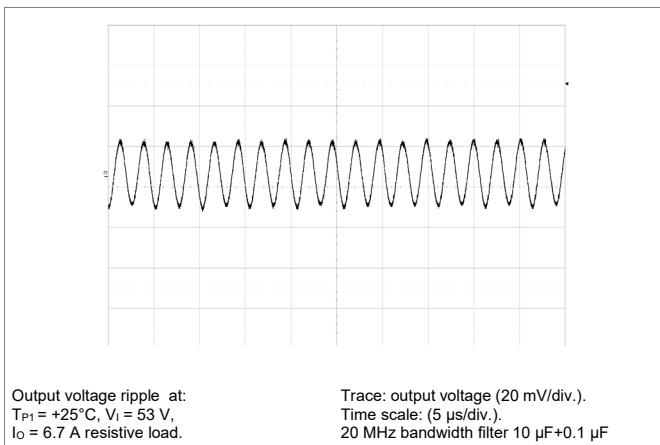

#### Output Load Transient Response

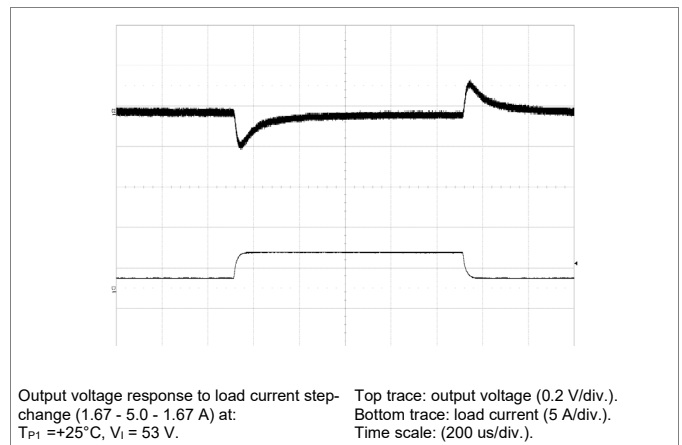

#### Output Voltage Adjust (see operating information)

##### Passive adjust

The resistor value for an adjusted output voltage is calculated by using the following equations:

Output Voltage Adjust Upwards, Increase:

$$R_{adj} = 5.11 \times \left( \frac{30(100 + \Delta\%)}{1.2 \times \Delta\%} - \frac{(100 + 2 \times \Delta\%)}{\Delta\%} \right) \text{ k}\Omega$$

Example: Increase 4%  $\Rightarrow V_{out} = 31.2\text{ Vdc}$

$$5.11 \times \left( \frac{30(100 + 4)}{1.2 \times 4} - \frac{(100 + 2 \times 4)}{4} \right) \text{ k}\Omega = 3183 \text{ k}\Omega$$

Output Voltage Adjust Downwards, Decrease:

$$R_{adj} = 5.11 \times \left( \frac{100}{\Delta\%} - 2 \right) \text{ k}\Omega$$

Example: Decrease 2%  $\Rightarrow V_{out} = 29.4\text{ Vdc}$

$$5.11 \times \left( \frac{100}{2} - 2 \right) \text{ k}\Omega = 245 \text{ k}\Omega$$

##### Active trimming formula:

$$V_{out} = 15.03 + 12.27 \times V_c$$

$V_{out}$ : output voltage

$V_c$ : control voltage between  $V_{adj}$  and -sense

**PKB4216C Series Fully Regulated DC-DC Converters**  
 Input 36-75 V, Output up to 6.67 A / 200 W

28701-BMR672 Rev.G

Oct 2022

© Flex

**Typical Characteristics**  
**30 V, 6.7 A / 200 W**

**PKB4216C**

**Output Current Derating – Open frame**

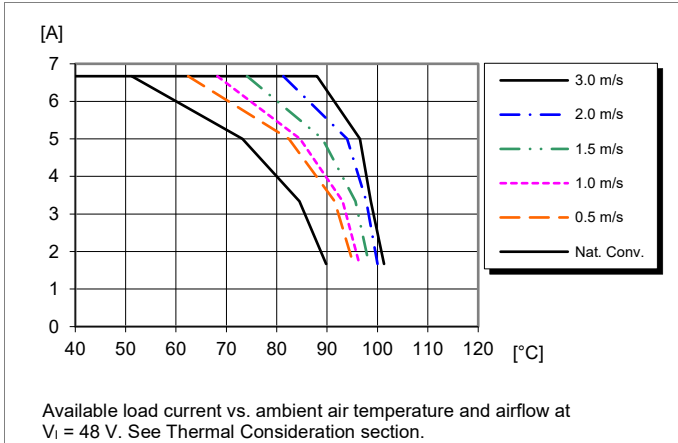

**Output Current Derating – Base plate**

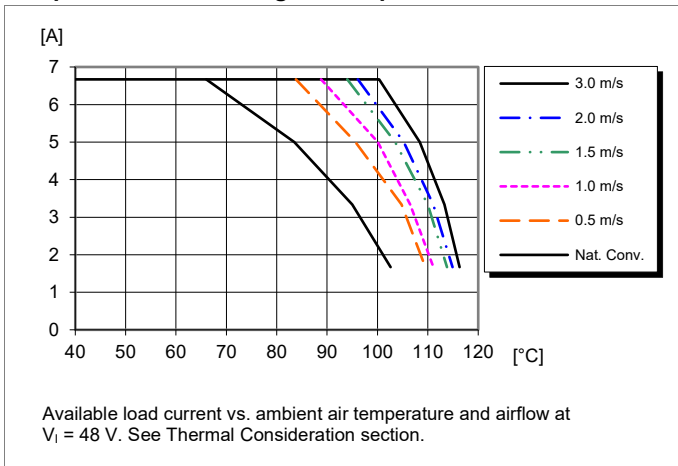

**Thermal Resistance – Base plate**

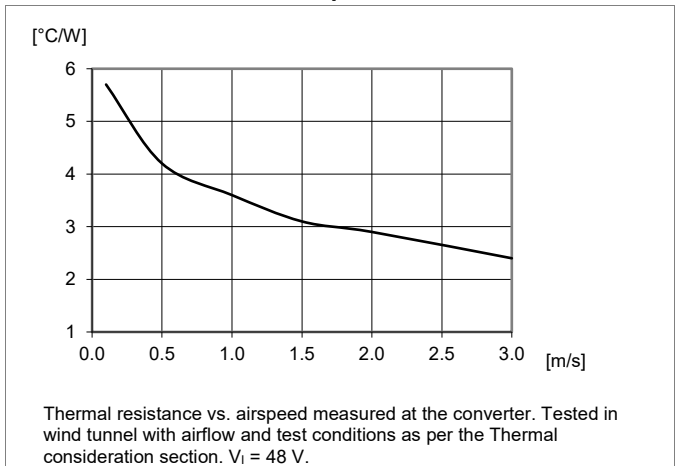

**Output Current Derating – Cold wall sealed box**

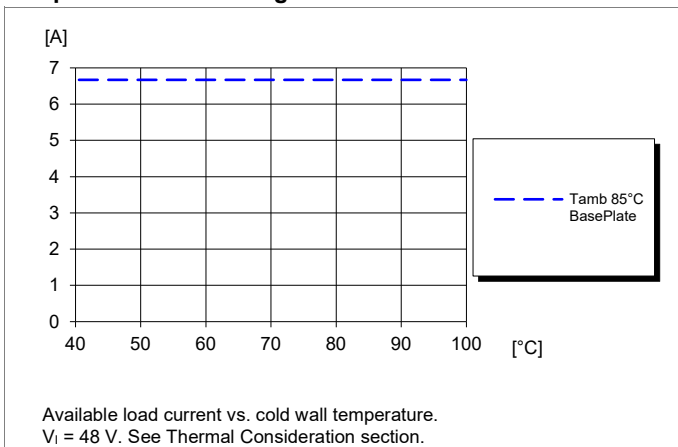



**PKB4216C Series Fully Regulated DC-DC Converters**  
 Input 36-75 V, Output up to 6.67 A / 200 W

28701-BMR672 Rev.G

Oct 2022

© Flex

### EMC Specification

Conducted EMI measured according to EN55022, CISPR 22 and FCC part 15J (see test set-up). See Design Note 009 for further information. The fundamental switching frequency is 400 kHz for PKB4216C. The EMI characteristics below is measured at  $V_I = 48\text{ V}$  and  $\text{max } I_O$ .

### Conducted EMI Input terminal value (typ)

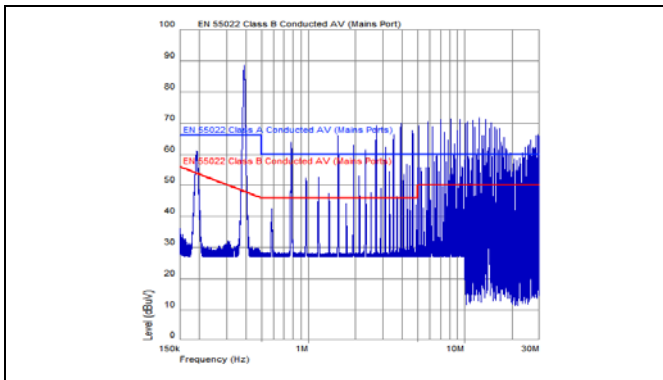

EMI without filter

### Optional external filter for class B

Suggested external input filter in order to meet class B in EN 55022, CISPR 22 and FCC part 15J.

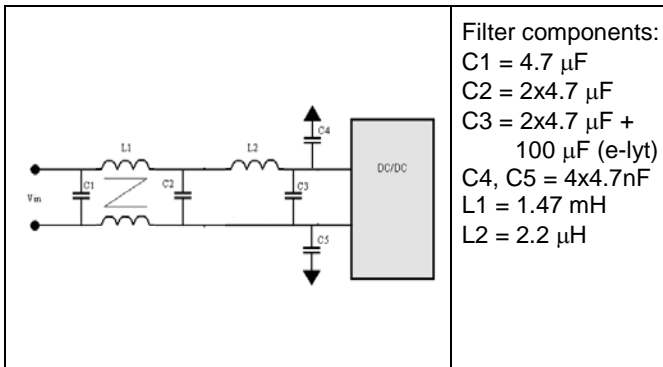

Filter components:  
 $C1 = 4.7\ \mu\text{F}$   
 $C2 = 2 \times 4.7\ \mu\text{F}$   
 $C3 = 2 \times 4.7\ \mu\text{F} + 100\ \mu\text{F (e-lyt)}$   
 $C4, C5 = 4 \times 4.7\ \text{nF}$   
 $L1 = 1.47\ \text{mH}$   
 $L2 = 2.2\ \mu\text{H}$

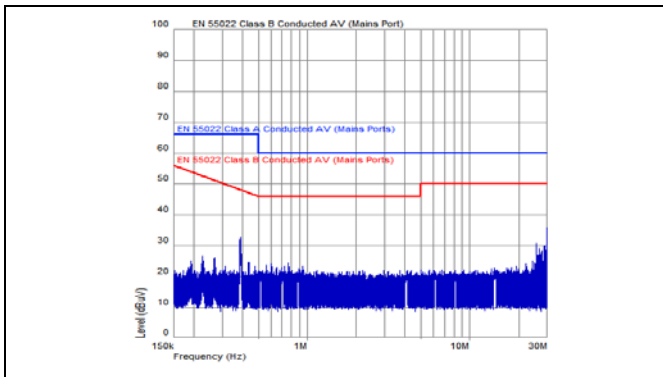

EMI with filter

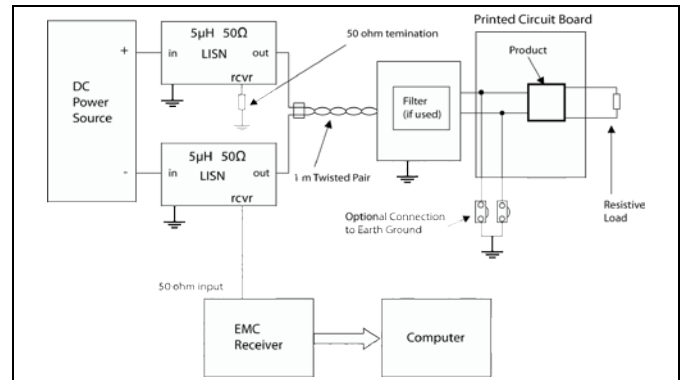

Test set-up

### Layout recommendations

The radiated EMI performance of the product will depend on the PWB layout and ground layer design. It is also important to consider the stand-off of the product. If a ground layer is used, it should be connected to the output of the product and to the equipment ground or chassis.

A ground layer will increase the stray capacitance in the PWB and improve the high frequency EMC performance.

### Output ripple and noise

Output ripple and noise is measured according to figure below. See Design Note 022 for detailed information.

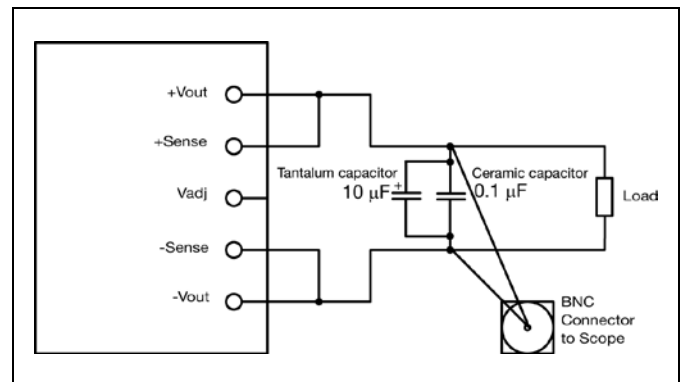

Output ripple and noise test setup

## PKB4216C Series Fully Regulated DC-DC Converters

Input 36-75 V, Output up to 6.67 A / 200 W

28701-BMR672 Rev.G

Oct 2022

© Flex

### Operating information

#### Input Voltage

The input voltage range 36 to 75 Vdc meets the requirements of the European Telecom Standard ETS 300 132-2 for normal input voltage range in -48 and -60 Vdc systems, -40.5 to -57.0 V and -50.0 to -72 V respectively.

At input voltages exceeding 75 V, the power loss will be higher than at normal input voltage and  $T_{P1}$  must be limited to absolute max +105°C. The absolute maximum continuous input voltage is 80 Vdc.

Short duration transient disturbances can occur on the DC distribution and input of the product when a short circuit fault occurs on the equipment side of a protective device (fuse or circuit breaker). The voltage level, duration and energy of the disturbance are dependent on the particular DC distribution network characteristics and can be sufficient to damage the product unless measures are taken to suppress or absorb this energy. The transient voltage can be limited by capacitors and other energy absorbing devices like Zener diodes connected across the positive and negative input conductors at a number of strategic points in the distribution network. The end-user must secure that the transient voltage will not exceed the value stated in the Absolute maximum ratings. ETSI TR 100 283 examines the parameters of DC distribution networks and provides guidelines for controlling the transient and reduce its harmful effect.

#### Turn-off Input Voltage

The products monitor the input voltage and will turn on and turn off at predetermined levels. The minimum hysteresis between turn on and turn off input voltage is 1 V.

#### Remote Control (RC)

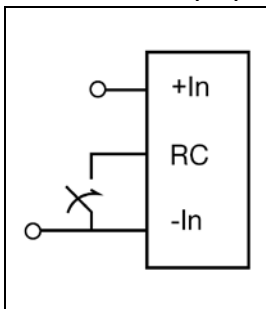

The products are fitted with a remote control function referenced to the primary negative input connection (-In), with negative and positive logic options available. The RC function allows the product to be turned on/off by an external device like a semiconductor or mechanical switch. The RC pin has an internal pull up resistor of 10 kΩ to +5V.

The external device must provide a minimum required sink current to guarantee a voltage not higher than maximum voltage on the RC pin (see Electrical characteristics table). When the RC pin is left open, the voltage generated on the RC pin is 5 V.

The standard product is provided with “negative logic” RC. To turn off the product the RC pin should be left open, or connected to a voltage higher than 4 V referenced to -In. In

situations where it is desired to have the product to power up automatically without the need for control signals or a switch, the RC pin can be wired directly to -In. To turn on the product the RC pin should be lower than 1V referenced to -In.

The second option is “positive logic” remote control, which can be ordered by adding the suffix “P” to the end of the part number. When the RC pin is left open, the product starts up automatically when the input voltage is applied. Turn off is achieved by connecting the RC pin to the -In, or a voltage lower than 1V referenced to -In. The product will restart automatically when this connection is opened.

The RC function incorporates a short delay in order to not trigger on glitches. Typically this filter has a settling time of 0.1-0.5 ms. This setup reduces the risk that the noise may cause the converter to shut down or power up accidentally.

See Design Note 021 for detailed information.

#### Input and Output Impedance

The impedance of both the input source and the load will interact with the impedance of the product. It is important that the input source has low characteristic impedance. The products are designed for stable operation with a minimum of 100uF external capacitors connected to the input and output. The electrolytic capacitors will be degraded in low temperature and the ESR value may increase. The needed input capacitance in low temperature should be equivalent to 100uF at 20° C. This means that the input capacitor value may need to be substantially larger to guarantee a stable input at low temperatures. The performance in some applications can be enhanced by addition of external capacitance as described under External Decoupling Capacitors.

The minimum required capacitance value depends on the output power and the input voltage. The higher output power the higher input capacitance is needed.

#### External Decoupling Capacitors

When powering loads with significant dynamic current requirements, the voltage regulation at the load can be improved by addition of decoupling capacitors at the load. The most effective technique is to locate low ESR ceramic and electrolytic capacitors as close to the load as possible, using several parallel capacitors to lower the effective ESR. The ceramic capacitors will handle high-frequency dynamic load changes while the electrolytic capacitors are used to handle low frequency dynamic load changes. It is equally important to use low resistance and low inductance PWB layouts and cabling.

External decoupling capacitors will become part of the product’s control loop. The control loop is optimized for a wide range of external capacitance and the maximum recommended value that could be used without any additional analysis is found in the Electrical specification. The ESR of the capacitors is a very important parameter.

## PKB4216C Series Fully Regulated DC-DC Converters

Input 36-75 V, Output up to 6.67 A / 200 W

28701-BMR672 Rev.G

Oct 2022

© Flex

Stable operation is guaranteed with a verified ESR value of  $>10\text{ m}\Omega$  across the output connections.

For further information please contact your local Flex Power Modules representative.

### Output Voltage Adjust ( $V_{\text{adj}}$ )

The products have an Output Voltage Adjust pin ( $V_{\text{adj}}$ ). This pin can be used to adjust the output voltage above or below Output voltage initial setting.

When increasing the output voltage, the voltage at the output pins (including any remote sense compensation) must be kept below the threshold of the over voltage protection (OVP), to prevent the product from shutting down. At increased output voltages the maximum power rating of the product remains the same, and the max output current must be decreased correspondingly. At minimum input voltage the output voltage adjust range may be decreased depending on load and temperature.

To increase the output voltage a resistor should be connected between the  $V_{\text{adj}}$  pin and +Sense pin. The value of the adjust resistor should be calculated according to the formulas provided in the Electrical Specification section for the respective product.

To decrease the output voltage, the resistor should be connected between the  $V_{\text{adj}}$  pin and -Sense pin.

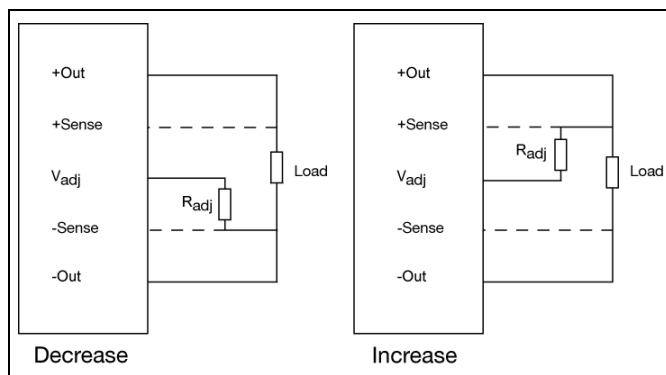

### Parallel Operation

This product is not designed for paralleling without using external current sharing circuits. See Design Note 006 for detailed information.

### Remote Sense

The products have remote sense that can be used to compensate for voltage drops between the output and the load. The sense traces should be located close to the PWB ground layer to reduce noise susceptibility. The remote sense circuitry will compensate for up to 10% voltage drop between output pins and the point of load.

If the remote sense is not needed +Sense should be connected to +Out and -Sense should be connected to -Out.

### Over Temperature Protection (OTP)

The products are protected from thermal overload by an internal over temperature shutdown circuit. When  $T_{P1}$  as defined in thermal consideration section exceeds  $130^{\circ}\text{C}$  the product will shut down. The product will make continuous attempts to start up (non-latching mode) and resume normal operation automatically when the temperature has dropped  $>10^{\circ}\text{C}$  below the temperature threshold.

### Over Voltage Protection (OVP)

The products have output over voltage protection that will shut down the product in over voltage conditions. The product will make continuous attempts to start up (non-latching mode) and resume normal operation automatically after removal of the over voltage condition.

### Over Current Protection (OCP)

The products include current limiting circuitry for protection at continuous overload. The OCP works in a hiccup mode and will make continuous attempts to start up and will resume normal operation automatically after removal of the over current condition. The load distribution should be designed for continuous overload. The OCP works in a hiccup mode and will make continuous attempts to start up and will resume normal operation automatically after removal of the over current condition. The load distribution should be designed for the specified maximum output short circuit current.

### Pre-bias Start-up

The product has a Pre-bias start up functionality and will not sink current during start up if a pre-bias load is present at the output terminals.

**PKB4216C Series Fully Regulated DC-DC Converters**  
 Input 36-75 V, Output up to 6.67 A / 200 W

28701-BMR672 Rev.G

Oct 2022

© Flex

### Thermal Consideration

#### General

The products are designed to operate in different thermal environments and sufficient cooling must be provided to ensure reliable operation.

For products mounted on a PWB without a baseplate attached, cooling is achieved mainly by conduction, from the pins to the host board, and convection, which is dependant on the airflow across the product. Increased airflow enhances the cooling of the product. The Output Current Derating graph found in the Output section for each model provides the available output current vs. ambient air temperature and air velocity at  $V_I = 48 V$ .

The product is tested on a 254 x 254 mm, 35  $\mu m$  (1 oz), 16-layer test board mounted vertically in a wind tunnel with a cross-section of 608 x 203 mm.

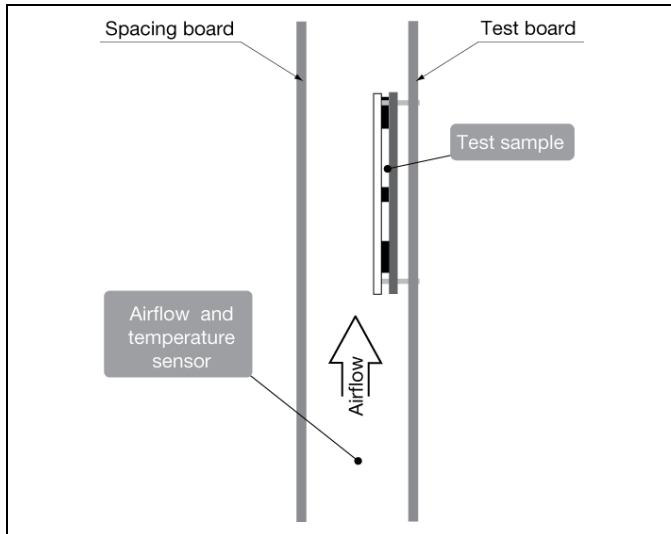

For products with baseplate or gap-pad used in a sealed box/cold wall application, cooling is achieved mainly by conduction through the cold wall. Modules without a base plate will have the best thermal performance if a profiled cold wall and gap filler is used. Look in the Thermal Management section for detailed drawings. The Output Current Derating graphs are found in the Output section for each model. The product performance has been tested in a sealed box presented in the figure below. The ambient temperature (inside the box) has been set to 85°C. The cold wall temperature varied. See Design Note 028 for further details.

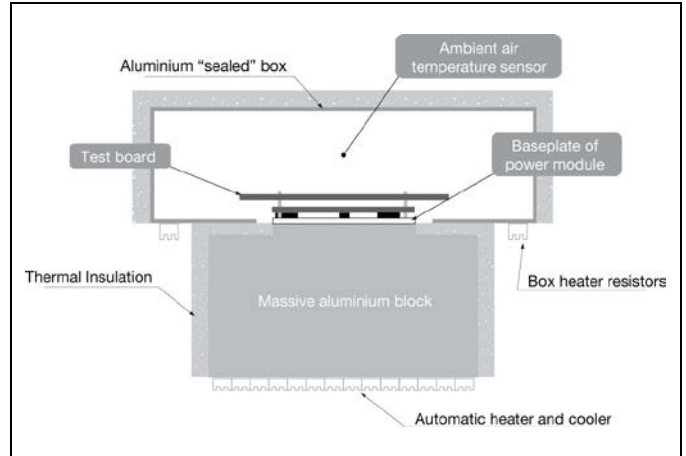

Gap-pad between cold wall and module ferrites:  
 Bergquist 5000S35, 2mm compressed to 1.2mm.  
 Hardness shore (00) 35.  
 Thermal conductivity 5.0 W/m-K

#### Definition of product operating temperature

The temperature at the positions ( $T_{P1}$ ,  $T_{P2}$ ,  $T_{P3}$ ,  $T_{P4}$ ) should not exceed the maximum temperatures in the table below. The number of measurement points may vary with different thermal design and topology. Temperatures above maximum measured at the reference point P1, P2, P3, P4 are not allowed and may cause permanent damage.

Position	Description	Max Temp.
P1	Mosfet, Reference point	$T_{P1} = 125^\circ C$
P2	Resistor	$T_{P2} = 125^\circ C$
P3	Opto-coupler	$T_{P3} = 110^\circ C$
P4	Mosfet, Reference point, baseplate	$T_{P4} = 125^\circ C$

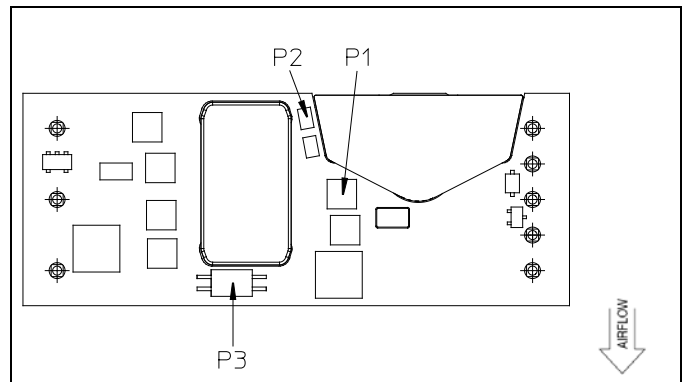

Open frame

**PKB4216C Series Fully Regulated DC-DC Converters**  
 Input 36-75 V, Output up to 6.67 A / 200 W

28701-BMR672 Rev.G

Oct 2022

© Flex

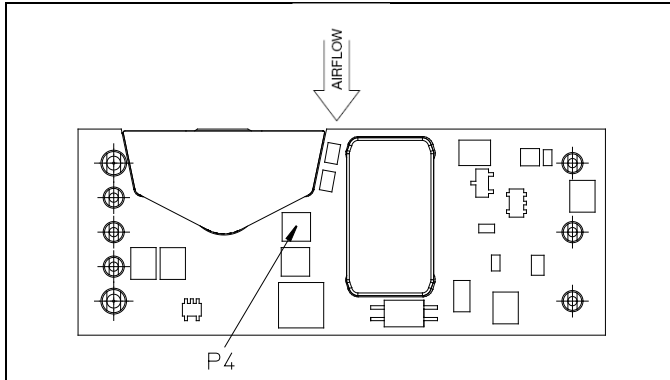

Baseplate

### Connections

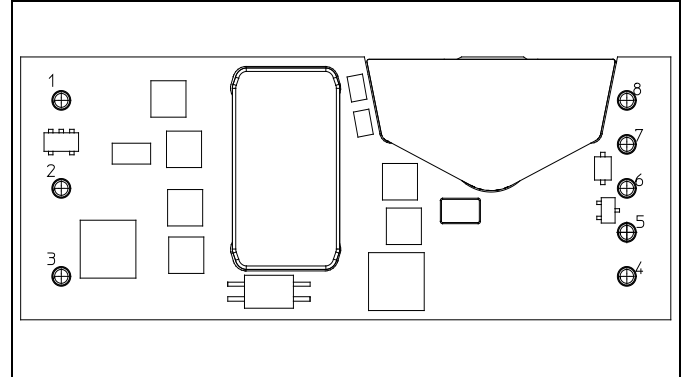

### Ambient Temperature Calculation

For products with base plate the maximum allowed ambient temperature can be calculated by using the thermal resistance.

- The power loss is calculated by using the formula  $((1/\eta) - 1) \times \text{output power} = \text{power losses (Pd)}$ .  
 $\eta$  = efficiency of product. E.g. 94.5% = 0.945
- Find the thermal resistance (Rth) in the Thermal Resistance graph found in the Output section for each model. **Note that the thermal resistance can be significantly reduced if a heat sink is mounted on the top of the base plate.**

Calculate the temperature increase ( $\Delta T$ ).

$$\Delta T = R_{th} \times P_d$$

3. Max allowed ambient temperature is:

$$\text{Max } T_{P1} - \Delta T.$$

E.g. PKB4216C at 1m/s:

- $((\frac{1}{0.945}) - 1) \times 200 \text{ W} = 11.6 \text{ W}$
- $11.6 \text{ W} \times 4.6^\circ\text{C/W} = 53.5^\circ\text{C}$
- $125^\circ\text{C} - 53.5^\circ\text{C} = \text{max ambient temperature is } 71.5^\circ\text{C}$

The actual temperature will be dependent on several factors such as the PWB size, number of layers and direction of airflow.

Pin	Designation	Function
1	+In	Positive Input
2	RC	Remote Control
3	-In	Negative Input
4	-Out	Negative Output
5	-Sense	Negative Remote Sense
6	Vadj	Output Voltage Adjust
7	+Sense	Positive Remote Sense
8	+Out	Positive Output

**PKB4216C Series Fully Regulated DC-DC Converters**  
 Input 36-75 V, Output up to 6.67 A / 200 W

28701-BMR672 Rev.G

Oct 2022

© Flex

**Mechanical Information – Surface Mount Version**

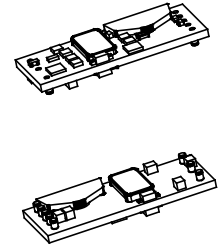
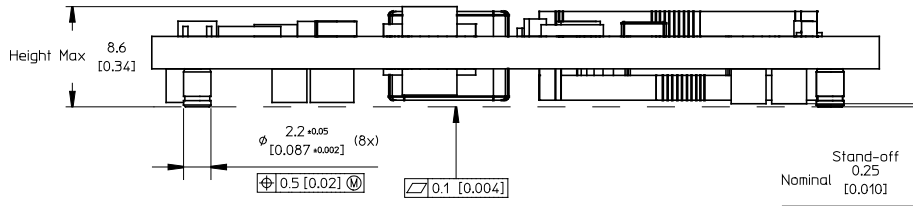

TOP VIEW

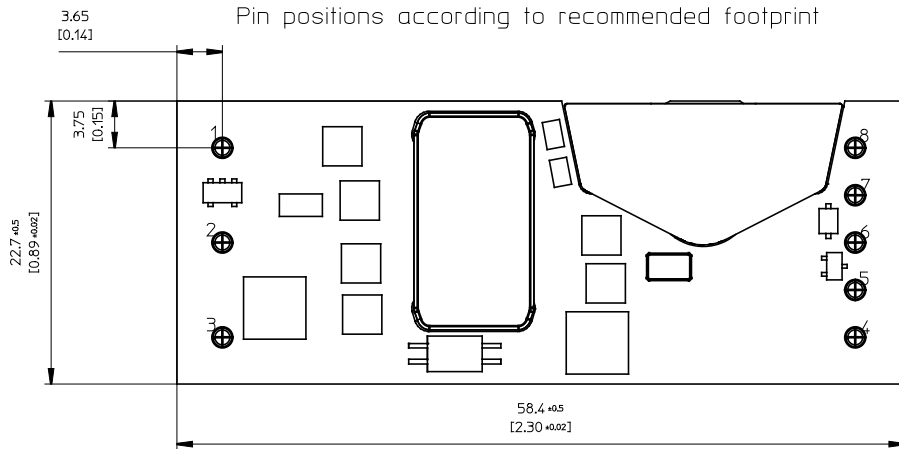

RECOMMENDED FOOTPRINT - TOP VIEW

PIN SPECIFICATIONS

Pin 1-8 Material: Copper alloy  
 Plating: Min 0.1 µm Au over 1-3 µm Ni.

Recommended pad dimensions are only for reference. It is the end users decision based in different situations like production processes, substrate thickness etc.

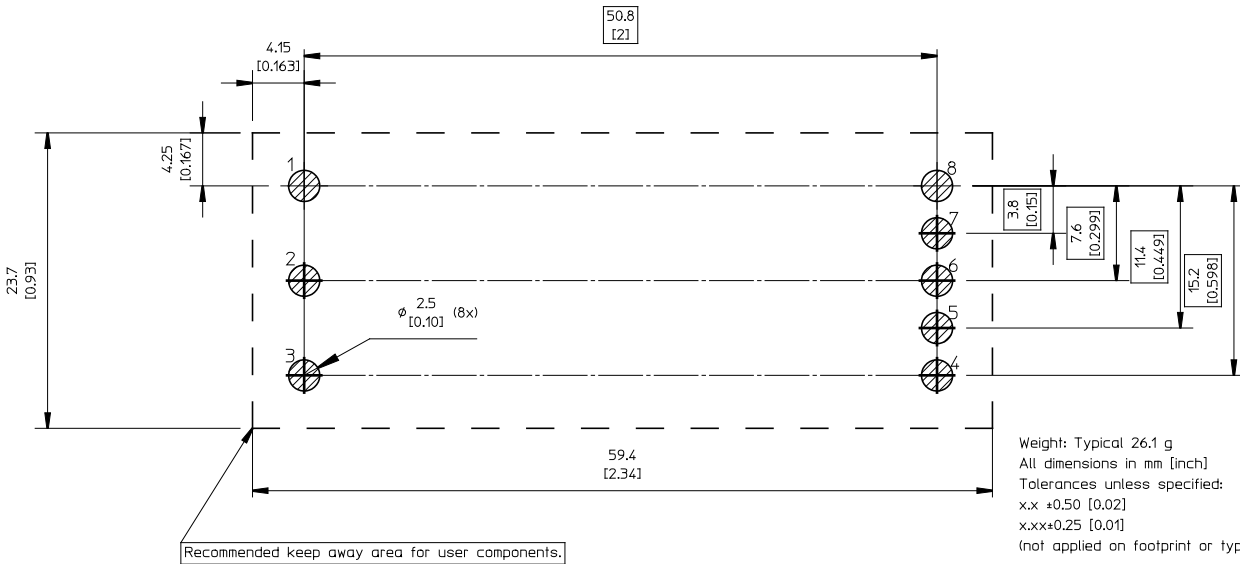

Weight: Typical 26.1 g  
 All dimensions in mm [inch]  
 Tolerances unless specified:  
 x.x ±0.50 [0.02]  
 x.xx±0.25 [0.01]  
 (not applied on footprint or typical values)



All component placements – whether shown as physical components or symbolical outline – are for reference only and are subject to change throughout the product's life cycle, unless explicitly described and dimensioned in this drawing.

**PKB4216C Series Fully Regulated DC-DC Converters**  
 Input 36-75 V, Output up to 6.67 A / 200 W

28701-BMR672 Rev.G

Oct 2022

© Flex

**Mechanical Information – Through hole Version**

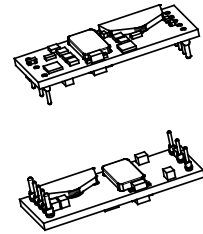
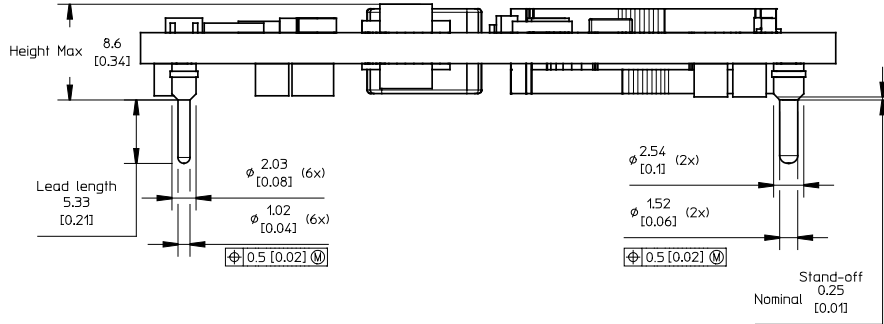

TOP VIEW

Pin positions according to recommended footprint

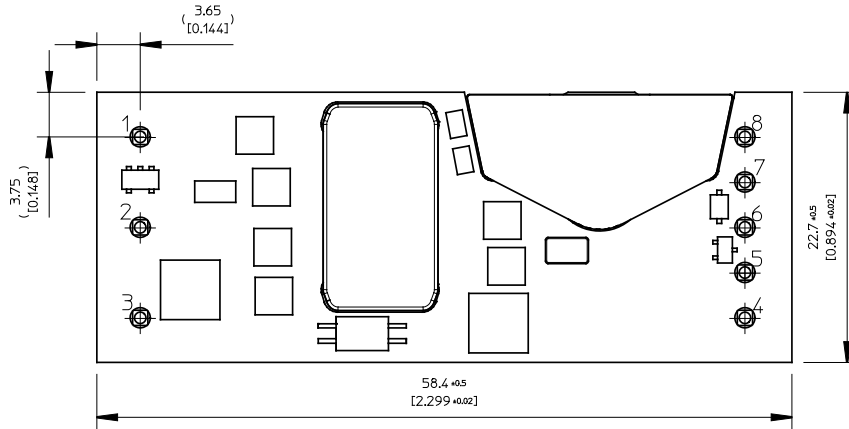

PIN SPECIFICATIONS

Pin 1-8 Material: Copper alloy  
 Plating: Min 0.1  $\mu$ m Au over 1-3  $\mu$ m Ni.

RECOMMENDED FOOTPRINT - TOP VIEW

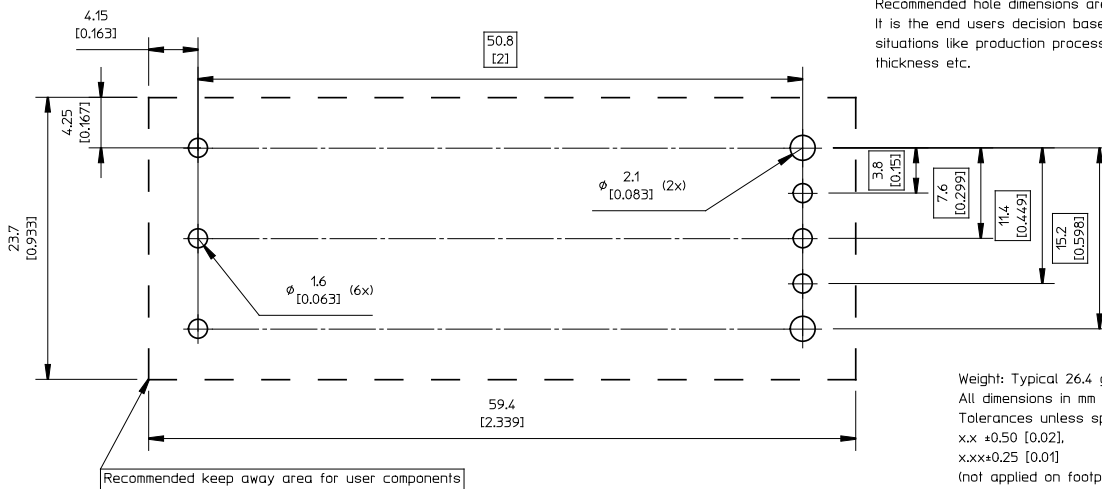

Recommended hole dimensions are only for reference. It is the end users decision based on different situations like production processes, substrate thickness etc.

Weight: Typical 26.4 g  
 All dimensions in mm  
 Tolerances unless specified:  
 x.x  $\pm$ 0.50 [0.02],  
 x.xx $\pm$ 0.25 [0.01]  
 (not applied on footprint or typical values)



**PKB4216C Series Fully Regulated DC-DC Converters**  
 Input 36-75 V, Output up to 6.67 A / 200 W

28701-BMR672 Rev.G

Oct 2022

© Flex

**Mechanical Information – Wing base plate Version**

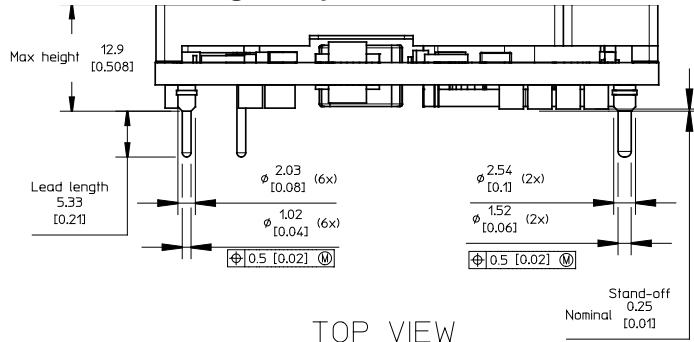

TOP VIEW

Pin positions according to recommended footprint

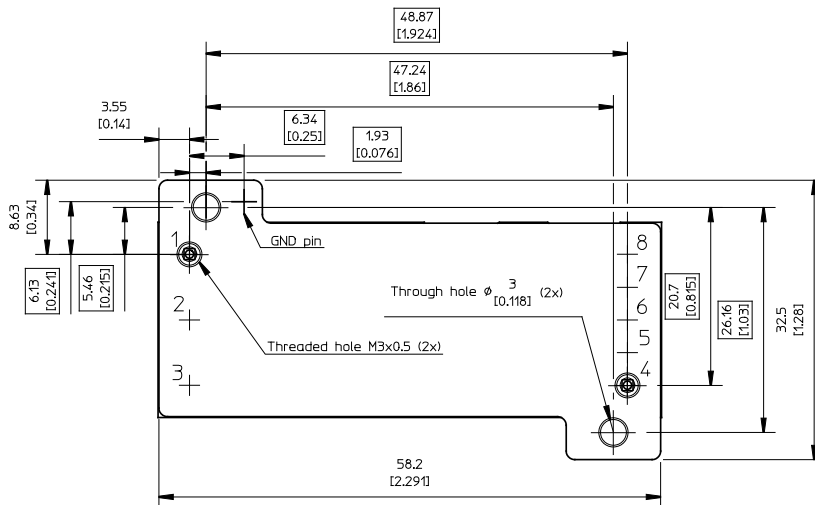

RECOMMENDED FOOTPRINT - TOP VIEW

CASE

Material: Aluminium

For screw attachment apply mounting torque of max 0.44 Nm [3.9 lbf in]. M3 screws must not protrude more than 3 mm [0.118] in to the base plate.

PIN SPECIFICATIONS

Pin 1-8 Material: Copper alloy

Plating: Min Au 0.1  $\mu$ m over 1-3  $\mu$ m Ni.

NOTE

GND pin is optional and pin specification applies to GND pin.

Recommended hole dimensions are only for reference. It is the end users decision based on different situations like production processes, substrate thickness etc.

Weight: Typical 59 g (59.2 g GND option)  
 All dimensions in mm [inch]  
 Tolerances unless specified:  
 x.x  $\pm$ 0.50 [0.02]  
 x.xx  $\pm$ 0.25 [0.01]  
 (not applied on footprint or typical values)





**PKB4216C Series Fully Regulated DC-DC Converters**  
 Input 36-75 V, Output up to 6.67 A / 200 W

28701-BMR672 Rev.G

Oct 2022

© Flex

**Mechanical Information – Base plate version**

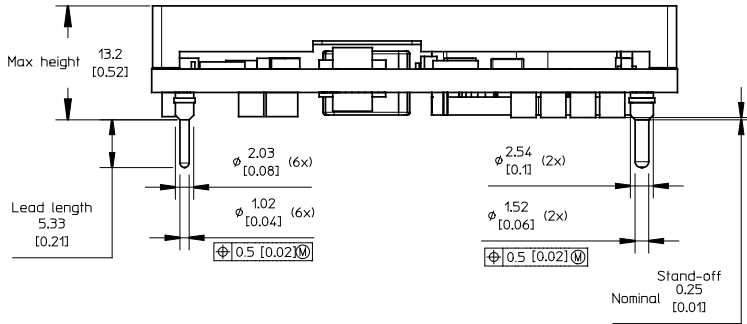

TOP VIEW

Pin positions according to recommended footprint

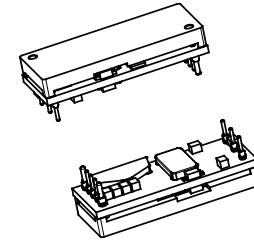

CASE  
 Material: Aluminium  
 For screw attachment apply mounting torque of max 0.44 Nm [3.9 lbf in]. M3 screws must not protrude more than 3 mm [0.118] in to the base plate.

PIN SPECIFICATIONS  
 Pin 1-8 Material: Copper alloy  
 Plating: Min Au 0.1 µm over 1-3 µm Ni.

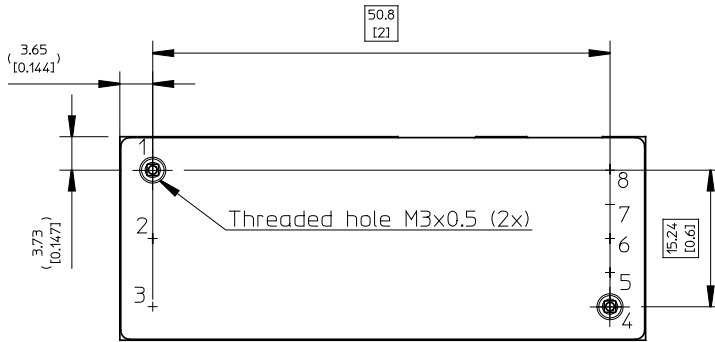

RECOMMENDED FOOTPRINT - TOP VIEW

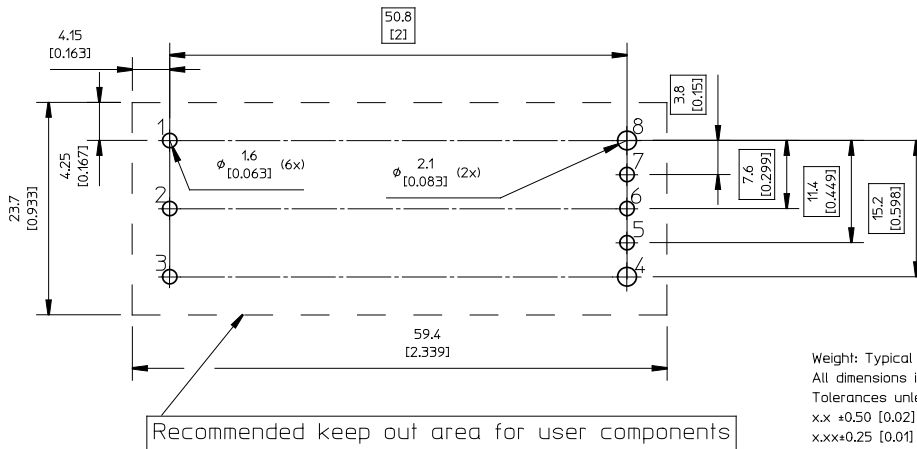

Weight: Typical 54 g  
 All dimensions in mm [inch]  
 Tolerances unless specified:  
 x.x +0.50 [0.02]  
 x.xx+0.25 [0.01]  
 (not applied on footprint or typical values)



**PKB4216C Series Fully Regulated DC-DC Converters**  
 Input 36-75 V, Output up to 6.67 A / 200 W

28701-BMR672 Rev.G

Oct 2022

© Flex

**Thermal Management**

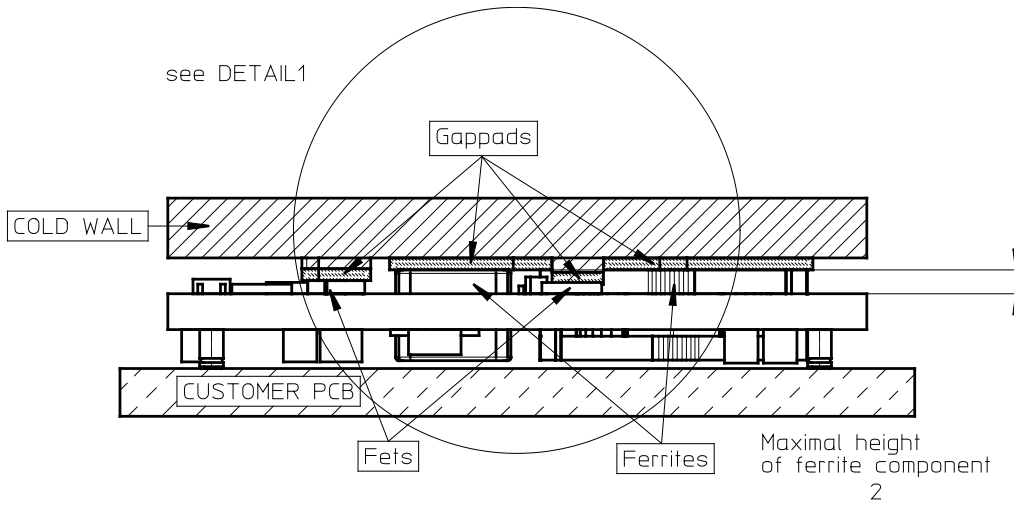

**Thermal pad:**

The thermal gap pads are intended to withdraw heat from ferrites and fets and transport the heat through the thermal material to the cold wall.

The gap pads must be carefully chosen in accordance with thermal conductivity and mounting pressure.

To choose the correct gap filler material, height difference between the two ferrites must be taken into consideration.

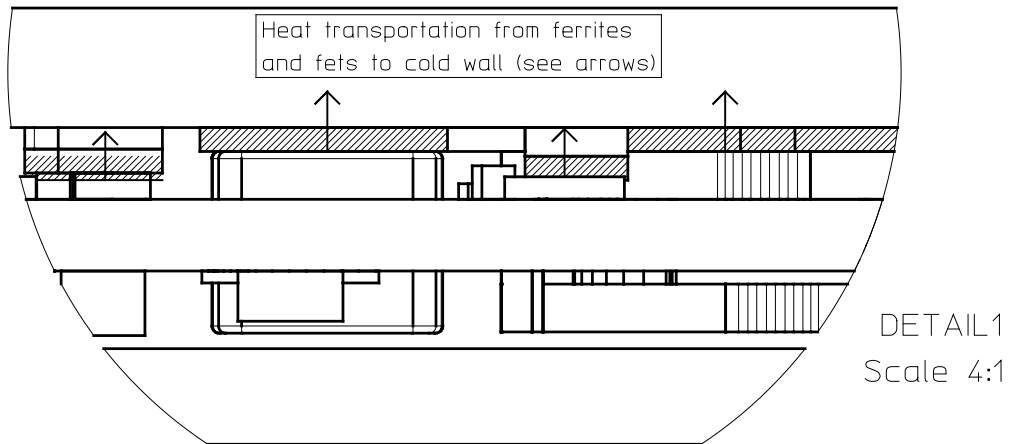

**PKB4216C Series Fully Regulated DC-DC Converters**  
 Input 36-75 V, Output up to 6.67 A / 200 W

28701-BMR672 Rev.G

Oct 2022

© Flex

Section A-A

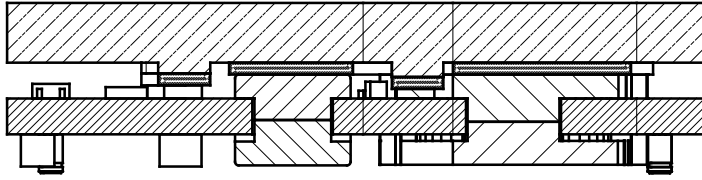

View above showing the milled protrusion for the fet's and the 1 mm gappads (see hatch explanation in right info box).

Section view showing

- COLDWALL:
- GAP PADS:
- PCB:

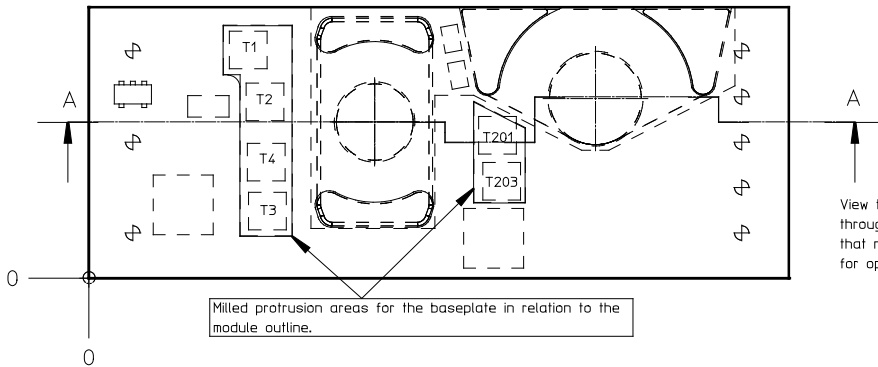

View to the left show module from top through the coldwall showing the two areas that needs to be milled to meet the FET's for optimal heat evacuation.

Milled protrusion areas for the baseplate in relation to the module outline.

COLD-WALL PROTRUSION DESIGN

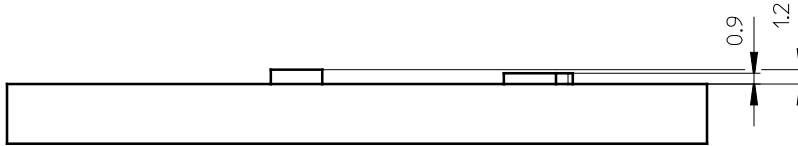

Dimensions for the two protrusions of the cold-wall dimensioned in relation to origo from top-view.

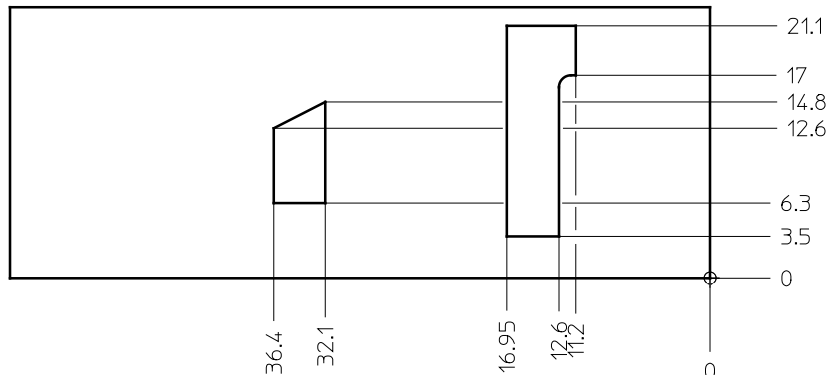

**PKB4216C Series Fully Regulated DC-DC Converters**  
 Input 36-75 V, Output up to 6.67 A / 200 W

28701-BMR672 Rev.G

Oct 2022

© Flex

**Soldering Information - Surface Mounting**

The surface mount product is intended for forced convection or vapor phase reflow soldering in SnPb and Pb-free processes.

The reflow profile should be optimised to avoid excessive heating of the product. It is recommended to have a sufficiently extended preheat time to ensure an even temperature across the host PWB and it is also recommended to minimize the time in reflow.

A no-clean flux is recommended to avoid entrapment of cleaning fluids in cavities inside the product or between the product and the host board, since cleaning residues may affect long time reliability and isolation voltage.

General reflow process specifications		SnPb eutectic	Pb-free
Average ramp-up ( $T_{PRODUCT}$ )		3°C/s max	3°C/s max
Typical solder melting (liquidus) temperature	$T_L$	183°C	221°C
Minimum reflow time above $T_L$		60 s	60 s
Minimum pin temperature	$T_{PIN}$	210°C	235°C
Peak product temperature	$T_{PRODUCT}$	225°C	260°C
Average ramp-down ( $T_{PRODUCT}$ )		6°C/s max	6°C/s max
Maximum time 25°C to peak		6 minutes	8 minutes

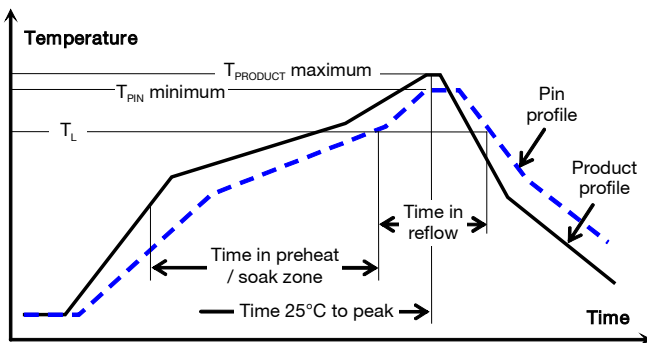

**Minimum Pin Temperature Recommendations**

Pin number 4 is chosen as reference location for the minimum pin temperature recommendation since this will likely be the coolest solder joint during the reflow process.

**SnPb solder processes**

For SnPb solder processes, a pin temperature ( $T_{PIN}$ ) in excess of the solder melting temperature, ( $T_L$ , 183°C for Sn63Pb37) for more than 60 seconds and a peak temperature of 220°C is recommended to ensure a reliable solder joint.

For dry packed products only: depending on the type of solder paste and flux system used on the host board, up to a recommended maximum temperature of 245°C could be used, if the products are kept in a controlled environment (dry pack handling and storage) prior to assembly.

**Lead-free (Pb-free) solder processes**

For Pb-free solder processes, a pin temperature ( $T_{PIN}$ ) in excess of the solder melting temperature ( $T_L$ , 217 to 221°C for SnAgCu solder alloys) for more than 60 seconds and a peak temperature of 245°C on all solder joints is recommended to ensure a reliable solder joint.

**Maximum Product Temperature Requirements**

Top of the product PWB near pin 2 is chosen as reference location for the maximum (peak) allowed product temperature ( $T_{PRODUCT}$ ) since this will likely be the warmest part of the product during the reflow process.

**SnPb solder processes**

For SnPb solder processes, the product is qualified for MSL 1 according to IPC/JEDEC standard J-STD-020C.

During reflow  $T_{PRODUCT}$  must not exceed 225 °C at any time.

**Pb-free solder processes**

For Pb-free solder processes, the product is qualified for MSL 3 according to IPC/JEDEC standard J-STD-020C.

During reflow  $T_{PRODUCT}$  must not exceed 260 °C at any time.

**Dry Pack Information**

Products intended for Pb-free reflow soldering processes are delivered in standard moisture barrier bags according to IPC/JEDEC standard J-STD-033 (Handling, packing, shipping and use of moisture/reflow sensitivity surface mount devices).

Using products in high temperature Pb-free soldering processes requires dry pack storage and handling. In case the products have been stored in an uncontrolled environment and no longer can be considered dry, the modules must be baked according to J-STD-033.

**Thermocoupler Attachment**

Top of PWB near pin 2 for measurement of maximum product temperature,  $T_{PRODUCT}$

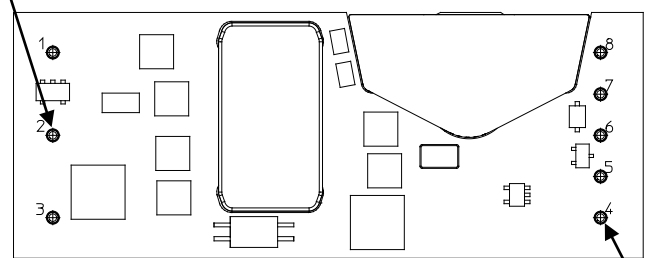

Pin 4 for measurement of minimum pin (solder joint) temperature,  $T_{PIN}$

**PKB4216C Series Fully Regulated DC-DC Converters**  
 Input 36-75 V, Output up to 6.67 A / 200 W

28701-BMR672 Rev.G

Oct 2022

© Flex

**Soldering Information - Hole Mounting**

The hole mounted product is intended for plated through hole mounting by wave or manual soldering. The pin temperature is specified to maximum to 270°C for maximum 10 seconds.

A maximum preheat rate of 4°C/s and maximum preheat temperature of 150°C is suggested. When soldering by hand, care should be taken to avoid direct contact between the hot soldering iron tip and the pins for more than a few seconds in order to prevent overheating.

A no-clean flux is recommended to avoid entrapment of cleaning fluids in cavities inside the product or between the product and the host board. The cleaning residues may affect long time reliability and isolation voltage.

**Delivery Package Information**

The products are delivered in antistatic injection molded trays (Jedec design guide 4.10D standard) and in antistatic trays.

Tray Specifications – SMD /Pin in paste	
<b>Material</b>	Antistatic PPE
<b>Surface resistance</b>	$10^5 < \text{Ohm/square} < 10^{12}$
<b>Bakability</b>	The trays can be baked at maximum 125°C for 48 hours
<b>Tray thickness</b>	17.40 mm 0.685 [inch]
<b>Box capacity</b>	100 products (5 full trays/box)
<b>Tray weight</b>	125 g empty, 630 g full tray

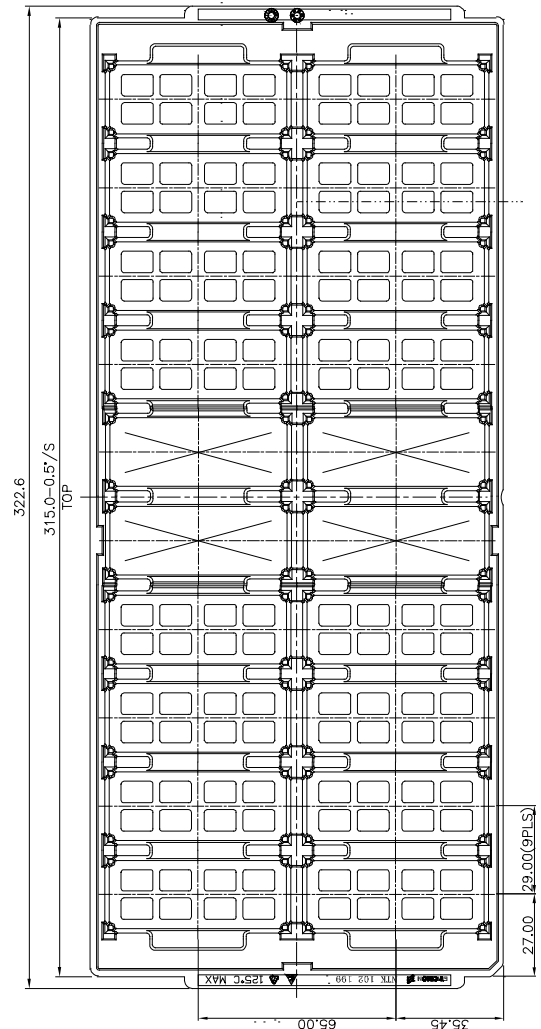

JEDEC standard tray for 2x10 = 20 products.  
 All dimensions in mm [inch]  
 Tolerances: X.x ±0.26 [0.01], X.xx ±0.13 [0.005]  
 Note: pick up positions refer to center of pocket.  
 See mechanical drawing for exact location on product.

**PKB4216C Series Fully Regulated DC-DC Converters**  
 Input 36-75 V, Output up to 6.67 A / 200 W

28701-BMR672 Rev.G

Oct 2022

© Flex

Tray Specifications – Through hole version	
<b>Material</b>	PE Foam, dissipative
<b>Surface resistance</b>	$10^5 < \text{Ohm/square} < 10^{12}$
<b>Bakability</b>	The trays are not bakable
<b>Tray thickness</b>	22 mm [0.866 inch]
<b>Box capacity</b>	100 products (4 full trays/box) Open frame 25 products (1 full tray/box) Base plate 20 products (1 full tray/box) Wing base plate
<b>Tray weight</b>	Product – Open frame 793 g full tray, 54 g empty tray Product – Base plate option 930 full tray, 60 g empty tray Product – Wing base plate option 880 full tray, 60 g empty tray

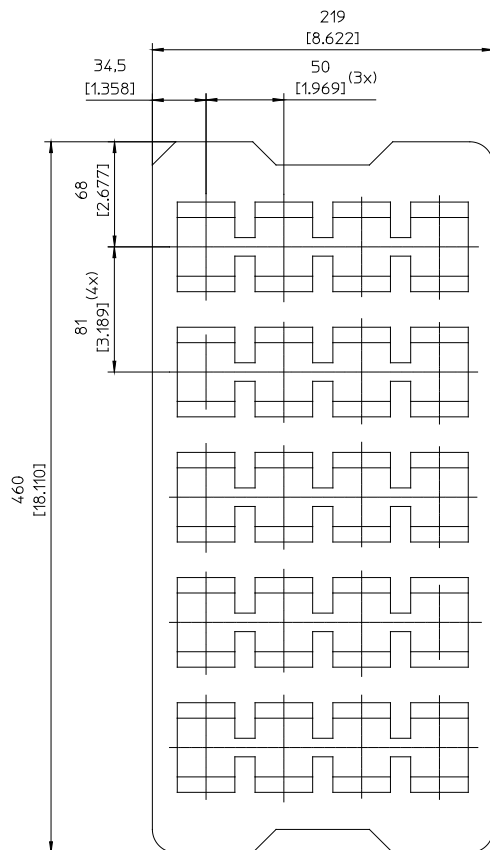

Soft tray for Wing base plate version

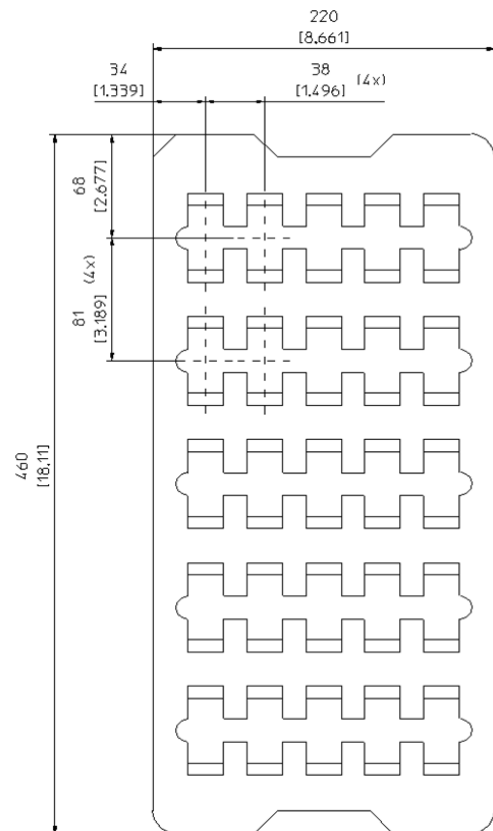

Soft tray for open frame & base plate version

**PKB4216C Series Fully Regulated DC-DC Converters**  
 Input 36-75 V, Output up to 6.67 A / 200 W

28701-BMR672 Rev.G

Oct 2022

© Flex

**Product Qualification Specification**

Characteristics			
External visual inspection	IPC-A-610		
Change of temperature (Temperature cycling)	IEC 60068-2-14 Na	Temperature range Number of cycles Dwell/transfer time	-40 to 100°C 1000 15 min/0-1 min
Cold (in operation)	IEC 60068-2-1 Ad	Temperature T <sub>A</sub> Duration	-45°C 72 h
Damp heat	IEC 60068-2-67 Cy	Temperature Humidity Duration	85°C 85 % RH 1000 hours
Dry heat	IEC 60068-2-2 Bd	Temperature Duration	125°C 1000 h
Electrostatic discharge susceptibility	IEC 61340-3-1, JESD 22-A114 IEC 61340-3-2, JESD 22-A115	Human body model (HBM) Machine Model (MM)	Class 1B, 500 V Class 3, 200 V
Immersion in cleaning solvents	IEC 60068-2-45 XA, method 2	Water Glycol ether Isopropyl alcohol	55°C 35°C 35°C
Mechanical shock	IEC 60068-2-27 Ea	Peak acceleration Duration	100 g 6 ms
Moisture reflow sensitivity <sup>1</sup>	J-STD-020C	Level 1 (SnPb-eutectic) Level 3 (Pb Free)	225°C 260°C
Operational life test	MIL-STD-202G, method 108A	Duration	1000 h
Resistance to soldering heat <sup>2</sup>	IEC 60068-2-20 Tb, method 1A	Solder temperature Duration	270°C 10-13 s
Robustness of terminations	IEC 60068-2-21 Test Ua1 IEC 60068-2-21 Test Ue1	Through hole mount products Surface mount products	All leads All leads
Solderability	IEC 60068-2-58 test Td <sup>1</sup>	Preconditioning Temperature, SnPb Eutectic Temperature, Pb-free	150°C dry bake 16 h 215°C 235°C
	IEC 60068-2-20 test Ta <sup>2</sup>	Preconditioning Temperature, SnPb Eutectic Temperature, Pb-free	Steam ageing 235°C 245°C
Vibration, broad band random	IEC 60068-2-64 Fh, method 1	Frequency Spectral density Duration	10 to 500 Hz 0.07 g <sup>2</sup> /Hz 10 min in each direction

## Notes

<sup>1</sup> Only for products intended for reflow soldering (surface mount products)<sup>2</sup> Only for products intended for wave soldering (plated through hole products)