

ALMD-EL3E, ALMD-EG3E, ALMD-CM3E, ALMD-CB3E

High Brightness SMT Round Amber, Red, Green, and Blue LED Lamps

Description

The Broadcom[®] ALMD-xx3E LED series has the same or just slightly less luminous intensity than conventional high brightness, through-hole LEDs.

The LED lamps can be assembled using common SMT assembly processes and are compatible with industrial reflow soldering processes.

The LEDs are made with an advanced optical grade epoxy for superior performance in outdoor sign applications.

For easy pick and place assembly, the LEDs are shipped in tape and reel. Every reel is shipped from a single intensity and color bin—except the red color—for better uniformity.

Features

- Compact form factor
- High brightness material
- Available in Red, Amber, Green, and Blue colors
 - Red AlInGaP 626 nm
 - Amber AlInGaP 590 nm
 - Green InGaN 525 nm
 - Blue InGaN 470 nm
- JEDEC MSL 2A
- Compatible with reflow soldering process
- Typical viewing angle: 30°
- Tinted lens

Applications

- Full color signs
- Mono color signs

CAUTION! InGaN devices are Class 1C HBM ESD sensitive, AlInGaP devices are Class 1B ESD sensitive per JEDEC Standard. Observe appropriate precautions during handling and processing. Refer to Application Note AN-1142 for additional details.

CAUTION! Keep the LED in the moisture barrier bag (MBB) with <5% RH when not in use because prolonged exposure to environment might cause the silver-plated leads to tarnish or rust, which might cause difficulties in soldering.

Figure 1: Package Dimensions

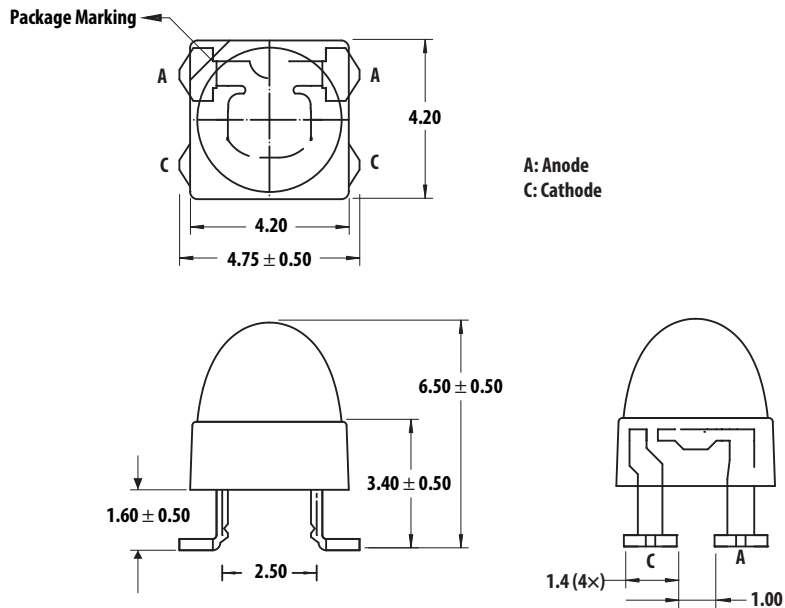
**NOTE:**

1. All dimensions are in millimeters.
2. Tolerance is ± 0.20 mm, unless other specified.
3. Mildsteel lead frame.

Device Selection Guide

Part Number	Color and Dominant Wavelength λ_d (nm) Typ ^a	Luminous Intensity I_v (mcd) ^{b, c, d}		Viewing Angle Typ (°) ^e
		Min	Max	
ALMD-EG3E-WY002	Red 626	5500	12000	30
ALMD-EG3E-XY002	Red 626	7200	12000	
ALMD-EL3E-WY002	Amber 590	5500	12000	
ALMD-EL3E-XYK02	Amber 590	7200	12000	
ALMD-CM3E-Y1002	Green 525	9300	21000	
ALMD-CB3E-SU002	Blue 470	1900	4200	

- a. Dominant wavelength, λ_d , is derived from the CIE Chromaticity Diagram and represents the color of the lamp.
- b. The luminous intensity is measured on the mechanical axis of the lamp package and it is tested with pulsing condition.
- c. The optical axis is closely aligned with the package mechanical axis.
- d. Tolerance for each bin limit is $\pm 15\%$.
- e. $\theta_{1/2}$ is the off-axis angle where the luminous intensity is half the on-axis intensity.

Part Numbering System

A L M D -

x ₁	x ₂	x ₃	x ₄
----------------	----------------	----------------	----------------

 -

x ₅	x ₆	x ₇	x ₈	x ₉
----------------	----------------	----------------	----------------	----------------

Code	Description	Option	
x ₁	Package type	E C	Round AlInGaP Round InGaN
x ₂	Color	B G L M	Blue Red Amber Green
x ₃	Viewing angle	3	30°
x ₄	Product specification designation	E	
x ₅	Minimum intensity bin	Refer to device selection guide	
x ₆	Maximum intensity bin	Refer to device selection guide	
x ₇	Color bin selection	0	Full distribution
		K	Color bins 2 and 4
x ₈ x ₉	Packaging option	02	Tested 20 mA, 13-in. carrier tape

Intensity Bin Limit Table (1.3:1 Iv Bin Ratio)

Bin	Intensity (mcd) at 20 mA	
	Min.	Max.
S	1900	2500
T	2500	3200
U	3200	4200
V	4200	5500
W	5500	7200
X	7200	9300
Y	9300	12000
Z	12000	16000
1	16000	21000

Tolerance for each bin limit is $\pm 15\%$.

V_F Bin Table (V at 20 mA) for Red and Amber Only

Bin ID	Min.	Max.
V _D	1.8	2.0
V _A	2.0	2.2
V _B	2.2	2.4

Tolerance for each bin limit is ± 0.05 V.

Red Color Range

Min. Dom.	Max. Dom.	X Min.	Y Min.	X Max.	Y Max.
618.0	630.0	0.6872	0.3126	0.6890	0.2943
		0.6690	0.3149	0.7080	0.2920

Tolerance for each bin limit is ± 0.5 nm.

Amber Color Range

Bin	Min. Dom.	Max. Dom.	X Min.	Y Min.	X Max.	Y Max.
1	584.5	587.0	0.5420	0.4580	0.5530	0.4400
			0.5370	0.4550	0.5570	0.4420
2	587.0	589.5	0.5570	0.4420	0.5670	0.4250
			0.5530	0.4400	0.5720	0.4270
4	589.5	592.0	0.5720	0.4270	0.5820	0.4110
			0.5670	0.4250	0.5870	0.4130
6	592.0	594.5	0.5870	0.4130	0.5950	0.3980
			0.5820	0.4110	0.6000	0.3990

Tolerance for each bin limit is ± 0.5 nm.

Green Color Range

Bin	Min. Dom.	Max. Dom.	X Min.	Y Min.	X Max.	Y Max.
1	519.0	523.0	0.0667	0.8323	0.1450	0.7319
			0.1200	0.7375	0.0979	0.8316
2	523.0	527.0	0.0979	0.8316	0.1711	0.7218
			0.1450	0.7319	0.1305	0.8189
3	527.0	531.0	0.1305	0.8189	0.1967	0.7077
			0.1711	0.7218	0.1625	0.8012
4	531.0	535.0	0.1625	0.8012	0.2210	0.6920
			0.1967	0.7077	0.1929	0.7816
5	535.0	539.0	0.1929	0.7816	0.2445	0.6747
			0.2210	0.6920	0.2233	0.7600

Tolerance for each bin limit is ± 0.5 nm.

Absolute Maximum Rating, $T_J = 25^\circ\text{C}$

Parameter	Red and Amber	Green	Blue	Units
DC Forward Current ^a	50	30	20	mA
Peak Forward Current	100 ^b	100 ^c	100 ^c	mA
Power Dissipation	120	114	76	mW
LED Junction Temperature	110			$^\circ\text{C}$
Operating Temperature Range	-40 to +85			$^\circ\text{C}$
Storage Temperature Range	-40 to +100			$^\circ\text{C}$

a. Derate linearly as shown in [Figure 5](#) and [Figure 10](#).

b. Duty factor 30%, frequency 1 kHz.

c. Duty factor 10%, frequency 1 kHz.

Blue Color Range

Bin	Min. Dom.	Max. Dom.	X Min.	Y Min.	X Max.	Y Max.
1	460.0	464.0	0.1440	0.0297	0.1766	0.0966
			0.1818	0.0904	0.1374	0.0374
2	464.0	468.0	0.1374	0.0374	0.1699	0.1062
			0.1766	0.0966	0.1291	0.0495
3	468.0	472.0	0.1291	0.0495	0.1616	0.1209
			0.1699	0.1062	0.1187	0.0671
4	472.0	476.0	0.1187	0.0671	0.1517	0.1423
			0.1616	0.1209	0.1063	0.0945
5	476.0	480.0	0.1063	0.0945	0.1397	0.1728
			0.1517	0.1423	0.0913	0.1327

Tolerance for each bin limit is ± 0.5 nm.

Electrical/Optical Characteristics, $T_J = 25\text{ }^\circ\text{C}$

Parameter	Symbol	Min.	Typ.	Max.	Units	Test Conditions
Forward Voltage Red Amber Green Blue	V_F	1.8 1.8 2.8 2.8	2.1 2.1 3.2 3.2	2.4 2.4 3.8 3.8	V	$I_F = 20\text{ mA}$
Reverse Voltage ^a Red and Amber Green and Blue	V_R	5 5			V	$I_R = 100\text{ }\mu\text{A}$ $I_R = 10\text{ }\mu\text{A}$
Dominant Wavelength ^b Red Amber Green Blue	λ_d	618.0 584.5 519.0 460.0	626.0 590.0 525.0 470.0	630.0 594.5 539.0 480.0	nm	$I_F = 20\text{ mA}$
Peak Wavelength Red Amber Green Blue	λ_{PEAK}		634 594 516 464		nm	Peak of Wavelength of Spectral Distribution at $I_F = 20\text{ mA}$
Thermal Resistance Red Amber Green Blue	$R_{\theta J-PIN}$		270 270 270 480		$^\circ\text{C/W}$	LED Junction-to-Pin
Luminous Efficacy ^c Red Amber Green Blue	η_V		200 490 530 65		lm/W	Emitted Luminous Power/Emitted Radiant Power
Thermal coefficient of λ_d Red Amber Green Blue			0.059 0.103 0.028 0.024		nm/ $^\circ\text{C}$	$I_F = 20\text{ mA}; +25^\circ\text{C} \leq T_J \leq +100^\circ\text{C}$

a. Indicates product final testing condition. Long-term reverse bias is not recommended.

b. The dominant wavelength is derived from the Chromaticity Diagram and represents the color of the lamp.

c. The radiant intensity, I_e in watts per steradian, may be found from the equation $I_e = I_V/\eta_V$ where I_V is the luminous intensity in candelas and η_V is the luminous efficacy in lumens/watt.

AlInGaP

Figure 2: Relative Intensity vs. Wavelength

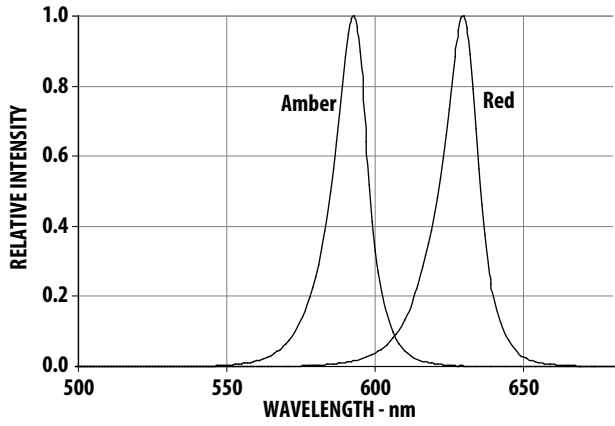

Figure 3: Forward Current vs. Forward Voltage

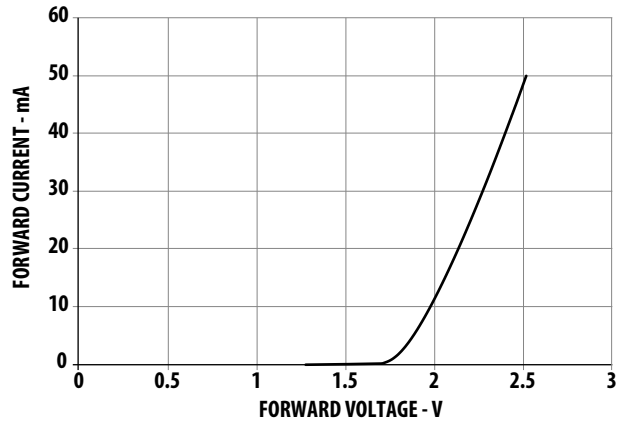

Figure 4: Relative Intensity vs. Forward Current

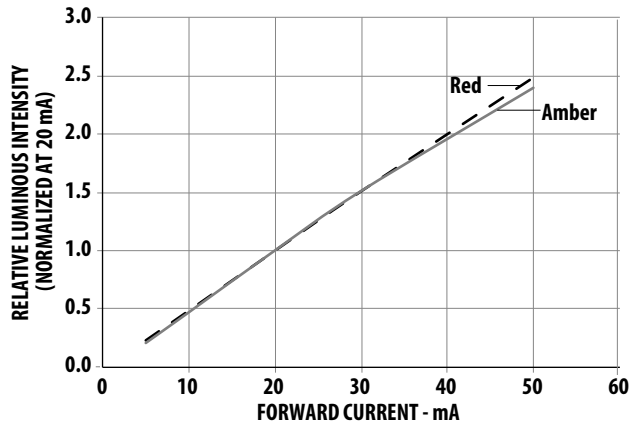

Figure 5: Maximum Forward Current vs. Ambient Temperature

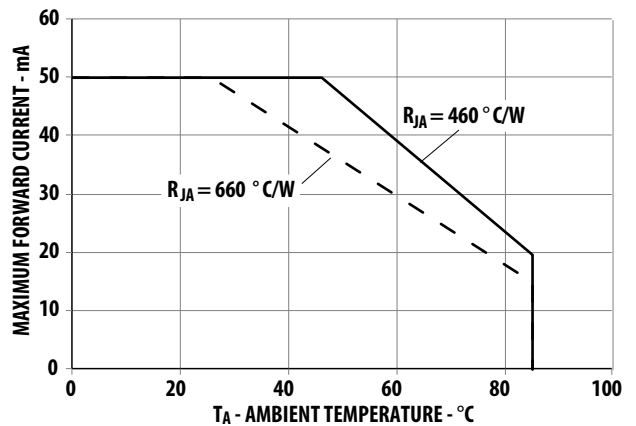
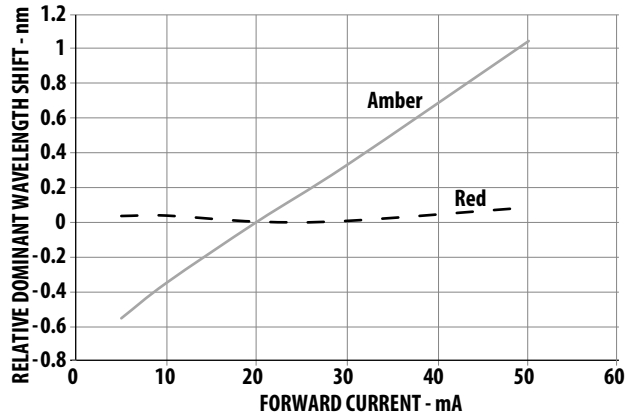

Figure 6: Relative Dominant Wavelength Shift vs. Forward Current



InGaN

Figure 7: Relative Intensity vs. Wavelength

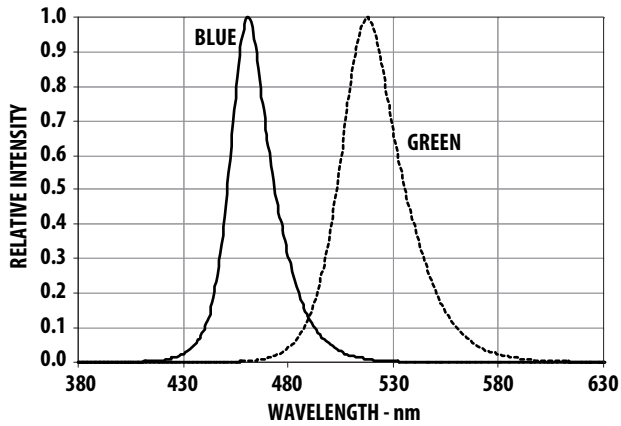

Figure 8: Forward Current vs. Forward Voltage

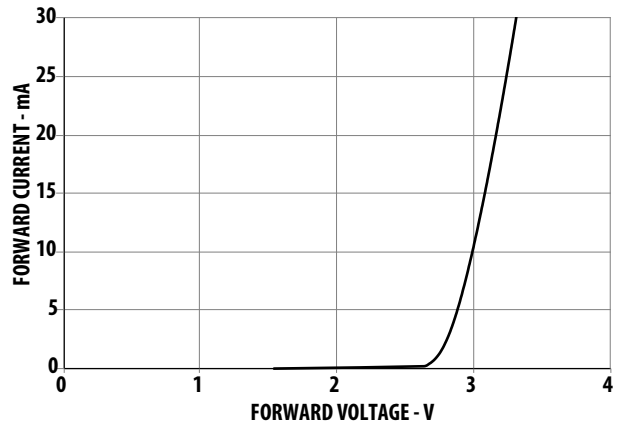

Figure 9: Relative Intensity vs. Forward Current

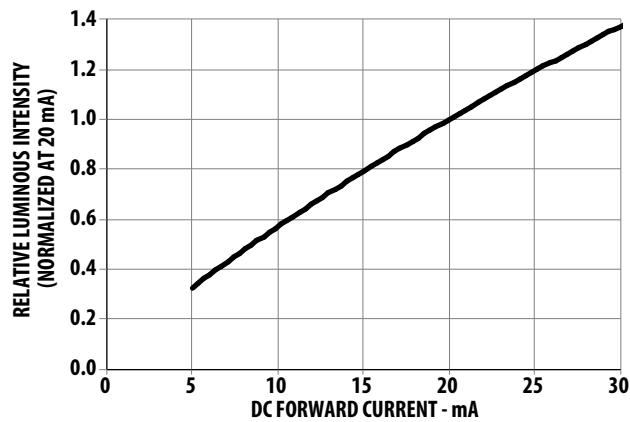

Figure 10: Maximum Forward Current vs. Ambient Temperature

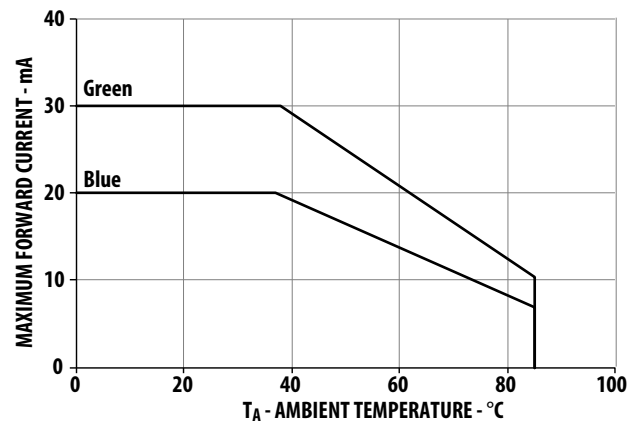

Figure 11: Dominant Wavelength Shift vs. Forward Current

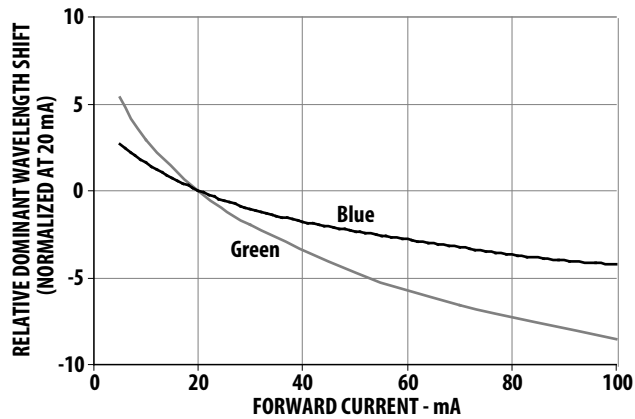

Figure 12: Radiation Pattern for X-Axis

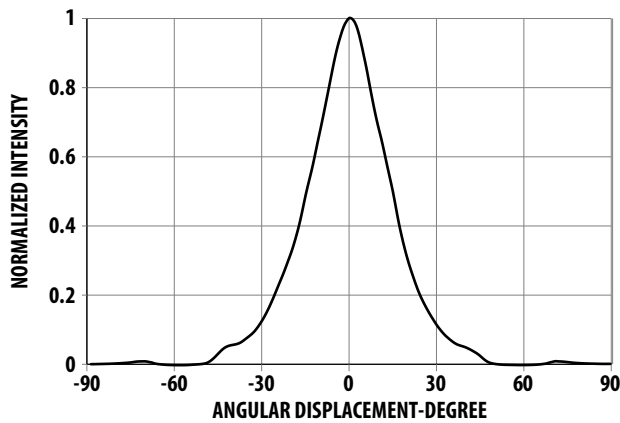

Figure 13: Component Axis for Radiation Pattern

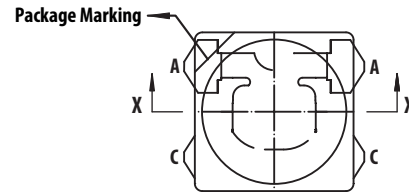

Figure 14: Relative Intensity Shift vs. Junction Temperature

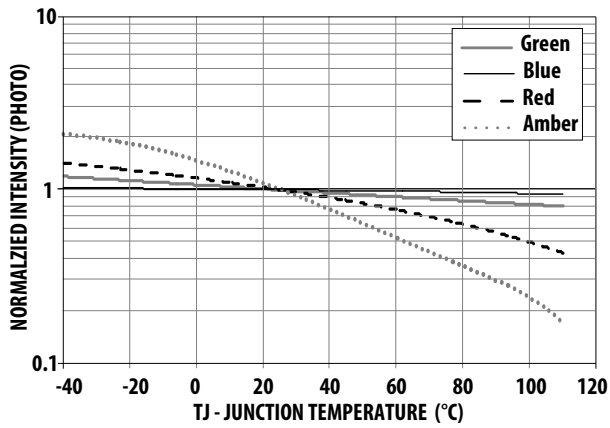

Figure 15: Forward Voltage Shift vs. Junction Temperature

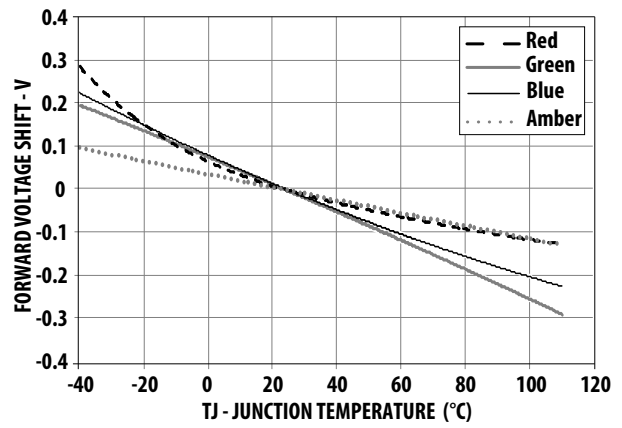
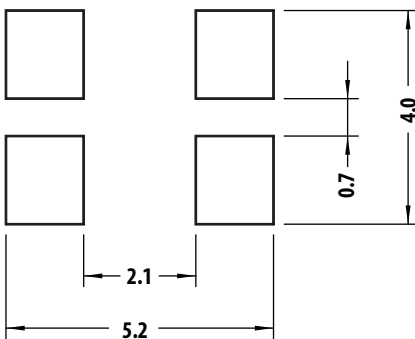
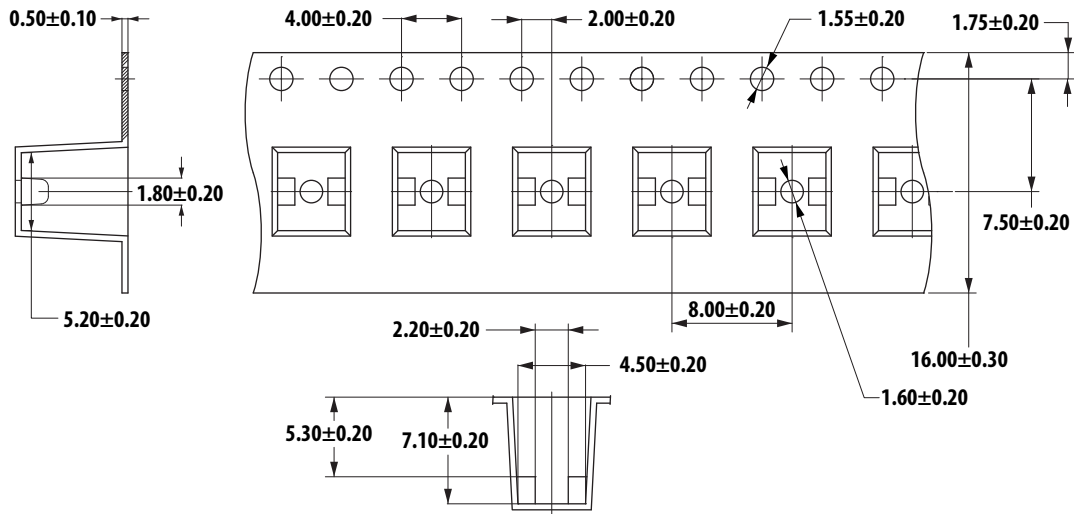

Figure 16: Recommended Soldering Land Pattern



NOTE: Recommended stencil thickness is 0.1524 mm (6 mils) minimum and above.

Figure 17: Carrier Tape Dimensions



NOTE: All dimensions are in mm.

Figure 18: Reel Dimension

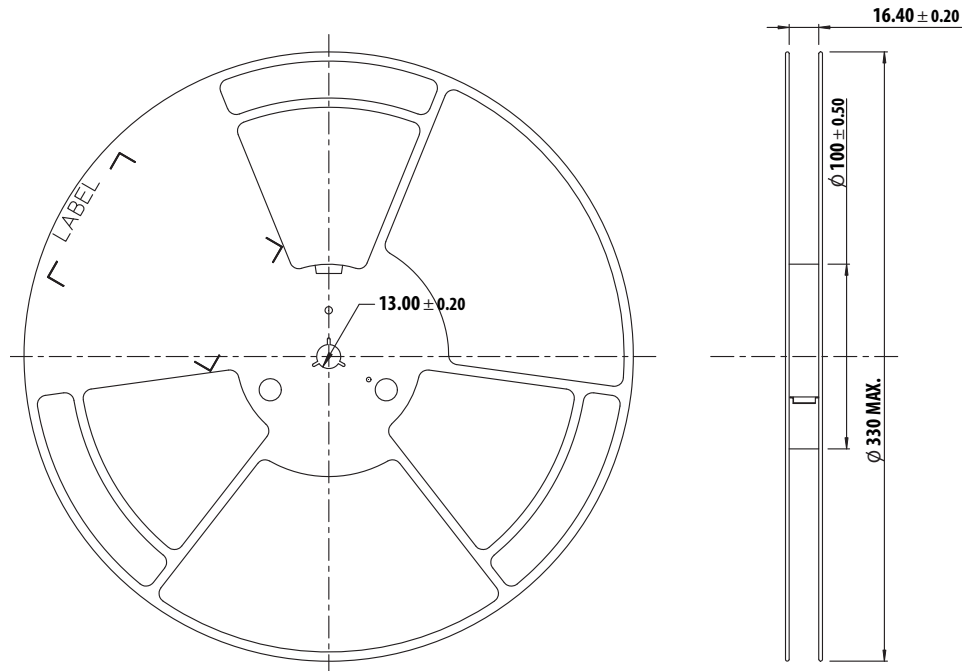

NOTE: All dimensions are in mm.

Figure 19: Unit Orientation from Reel

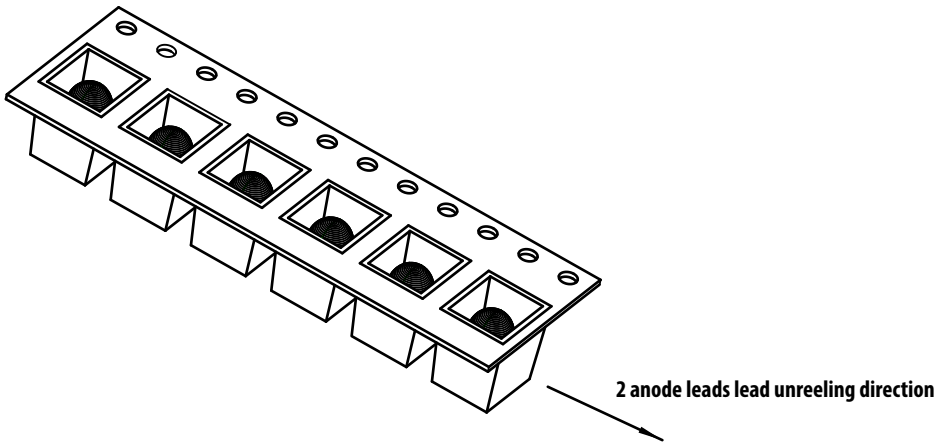

Soldering

Recommended reflow soldering conditions:

(i) Leaded reflow soldering

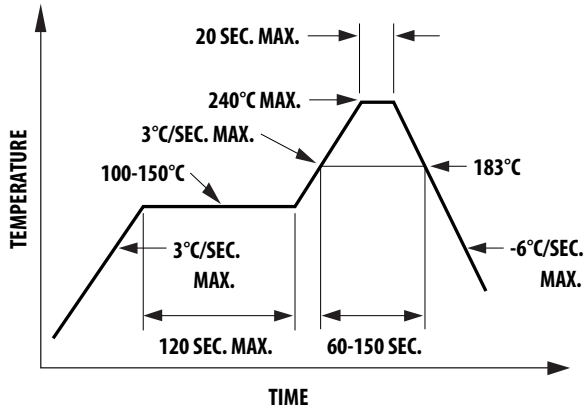

(ii) Lead-free reflow soldering

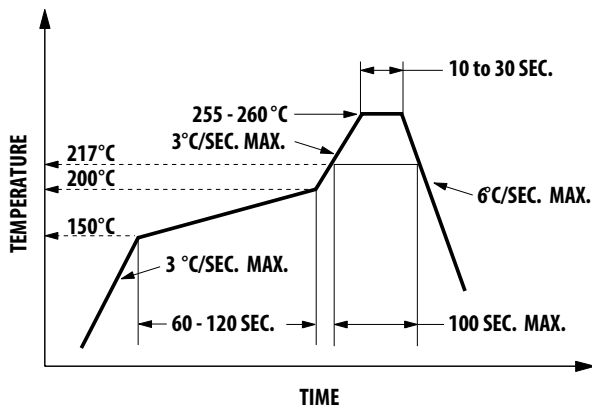

- Reflow soldering must not be done more than twice. Take the necessary precautions for handling a moisture-sensitive device, as stated in the following section.
- The recommended board reflow direction follows.

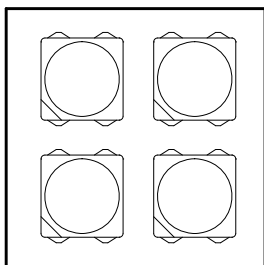

- Do not apply any pressure or force on the LED during reflow and after reflow when the LED is still hot.
- Use reflow soldering to solder the LED. Use hand soldering only for rework if unavoidable but must be strictly controlled to the following conditions:
 - Soldering iron tip temperature = 320°C maximum
 - Soldering duration = 3 seconds maximum
 - Number of cycles = 1 only
 - Power of soldering iron = 50 W maximum
- Do not touch the LED body with a hot soldering iron except the soldering terminals because this may damage the LED.
- For de-soldering, use a double-flat tip.
- Confirm beforehand whether the functionality and performance of the LED is affected by hand soldering.

Precautionary Notes

Handling Precautions

For automated pick-and-place, Broadcom has tested the following nozzle size made with urethane material to be work well with this LED. However, due to the possibility of variations in other parameters such as pick-and-place machine maker/model and other settings of the machine, verify the selected nozzle.

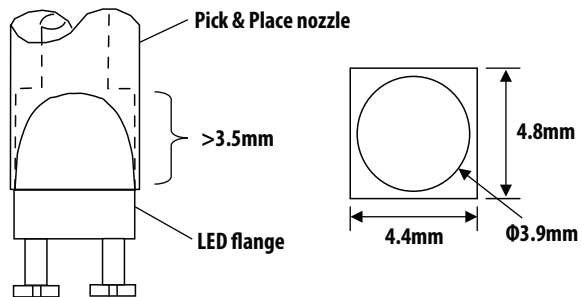

NOTE:

1. The nozzle tip should touch the LED flange during pick and place.
2. The outer dimensions of the nozzle should fit into the carrier tape pocket.

Handling of Moisture-Sensitive Devices

This product has a Moisture Sensitive Level 2a rating per JEDEC J-STD-020. Refer to Broadcom Application Note AN5305, *Handling of Moisture Sensitive Surface Mount Devices*, for additional details and a review of proper handling procedures.

Before use

- Store an unopened moisture barrier bag (MBB) at <math><40^{\circ}\text{C}/90\% \text{RH}</math> for 12 months. If the actual shelf life has exceeded 12 months and the humidity indicator card (HIC) indicates that baking is not required, it is safe to reflow the LEDs per the original MSL rating.
- Do not open the MBB prior to assembly (for example, for IQC).

Control after opening the MBB

- Read the HIC immediately upon opening of the MBB.
- Keep the LEDs at <math><30^{\circ}\text{C}/60\% \text{RH}</math> at all times, and complete all high-temperature-related processes, including soldering, curing, or rework, within 672 hours.

Control for unfinished reel

Store unused LEDs in a sealed MBB with desiccant or desiccator at <math><5\% \text{RH}</math>.

Control of assembled boards

If the PCB soldered with the LEDs is to be subjected to other high-temperature processes, store the PCB in a sealed MBB with desiccant or desiccator at <math><5\% \text{RH}</math> to ensure that all LEDs have not exceeded their floor life of 672 hours.

Baking is required if the following conditions exist

- The HIC indicator is not BROWN at 10% and is AZURE at 5%.
- The LEDs are exposed to conditions of $>30^{\circ}\text{C}/60\% \text{RH}$ at any time.
- The LEDs' floor life exceeded 672 hrs.

The recommended baking condition is $60^{\circ}\text{C} \pm 5^{\circ}\text{C}$ for 20 hours. Baking should only be done once.

Storage

The soldering terminals of these LEDs are silver plated. If the LEDs are exposed in an ambient environment for too long, the silver plating might be oxidized, which affects its solderability performance. As such, keep unused LEDs in sealed a MBB with desiccant or in desiccator at <math><5\% \text{RH}</math>.

Application Precautions

- The drive current of the LED must not exceed the maximum allowable limit across temperature as stated in the data sheet. Use constant current driving to ensure consistent performance.
- LEDs exhibit slightly different characteristics at different drive currents that might result in larger performance variations (such as, intensity, wavelength, and forward voltage). Set the application current as close as possible to the test current to minimize these variations.
- The LED is not intended for reverse bias. Use other appropriate components for such purposes. When driving the LED in matrix form, ensure that the reverse bias voltage does not exceed the allowable limit of the LED.
- Avoid rapid change in ambient temperatures, especially in high humidity environments, because these will cause condensation on the LED.
- If the LED is intended to be used in an outdoor or a harsh environment, protect the LED leads with suitable potting material against damages caused by rain water, oil, corrosive gases, and so on. Use a louver or a shade to reduce direct sunlight on the LEDs.

Eye Safety Precautions

LEDs may pose optical hazards when in operation. Do not look directly at operating LEDs because it may be harmful to the eyes. For safety reasons, use appropriate shielding or personal protective equipment.

Disclaimer

Broadcom's products and software are not specifically designed, manufactured, or authorized for sale as parts, components, or assemblies for the planning, construction, maintenance, or direct operation of a nuclear facility or for use in medical devices or applications. The customer is solely responsible, and waives all rights to make claims against Broadcom or its suppliers, for all loss, damage, expense, or liability in connection with such use.

Broadcom, the pulse logo, Connecting everything, Avago Technologies, Avago, and the A logo are among the trademarks of Broadcom and/or its affiliates in the United States, certain other countries, and/or the EU.

Copyright © 2016–2020 Broadcom. All Rights Reserved.

The term "Broadcom" refers to Broadcom Inc. and/or its subsidiaries. For more information, please visit www.broadcom.com.

Broadcom reserves the right to make changes without further notice to any products or data herein to improve reliability, function, or design. Information furnished by Broadcom is believed to be accurate and reliable. However, Broadcom does not assume any liability arising out of the application or use of this information, nor the application or use of any product or circuit described herein, neither does it convey any license under its patent rights nor the rights of others.

