

Click to
ORDER
samples

AM30-NZ



Open frame

The AM30-NZ series is designed to offer an ultra-thin solution to customers with designs that have challenging height considerations. This series is available in both SIP and DIP packages with open frame and metal case options. The total height of 0.24inches (6.8mm) for the Dual Inline Package offers significant space optimization when compared to typical 3W DIP products with approximately twice the height (~0.4inches).

In addition, the AM30-NZ offers an impressive 500VAC or 1500VDC isolation with a 2:1 input voltage range of 4.5-9VDC or 4:1 input voltage range of 9-36VDC. It is also designed with input under-voltage protection, output over-voltage, over-current, short circuit protection, which enables the AM30-NZ series to be used in a variety of application related to industrial control, instrumentation and communication equipment.

Features

- Wide Input Range: 4.5VDC – 36VDC
- Operating Temp: -40 °C to +85 °C
- Low ripple & noise, 50mV(p-p) typ.
- Efficiency up to 82%
- Adjustable output voltage
- Output short circuit, over voltage protection
- Optional package: DIP/SMD
- Regulated Output

Summary

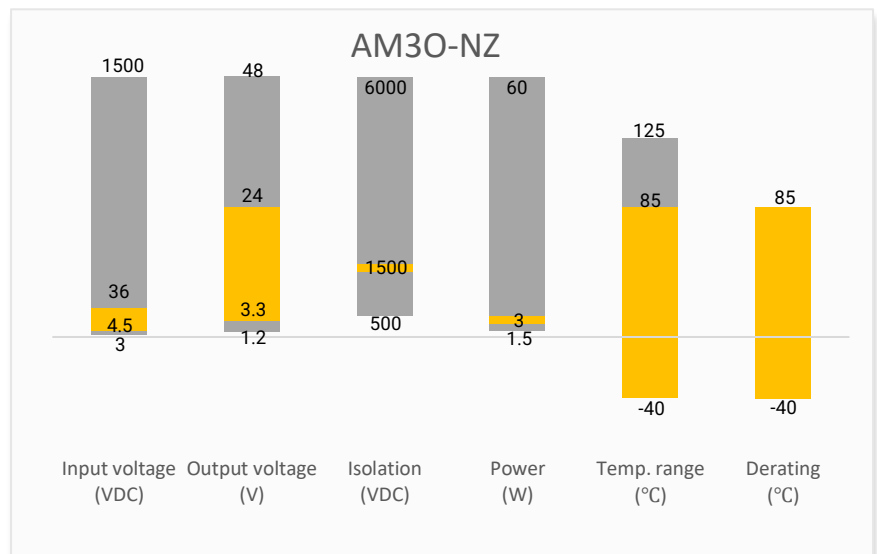

Training



Product Training Video
(click to open)



Press Release

Coming Soon!

Application Notes

Applications



Power Grid



Industrial



Telecom



Instrumentation

Models & Specifications

Single Output							
Model	Input Voltage (VDC)	Output Voltage (VDC)	Input Current Max (mA)		Output Current Max (mA)	Maximum Capacitive Load (μ F)	Efficiency Typ. (%) Full Load
			No Load	Full Load			
AM30-0505SNZ	5 (4.5 ~ 9)	5	45	857	600	470	72
AM30-0512SNZ	5 (4.5 ~ 9)	12	45	857	250	220	76
AM30-0515SNZ	5 (4.5 ~ 9)	15	45	857	200	100	77
AM30-0524SNZ	5 (4.5 ~ 9)	24	45	857	125	47	76
AM30-2403SNZ	24 (9 ~ 36)	3.3	15	169	909	1000	72
AM30-2405SNZ	24 (9 ~ 36)	5	15	169	600	1000	77
AM30-2412SNZ	24 (9 ~ 36)	12	15	169	250	470	81
AM30-2415SNZ	24 (9 ~ 36)	15	15	169	200	330	82
AM30-2424SNZ	24 (9 ~ 36)	24	15	169	125	100	81

Note: Use suffix "M" for DIP package with case, suffix "L" for SMD package without case and suffix "LM" for SMD package with case (ex. AM30-0505SNZ is DIP package without case, AM30-0505SNZ-M is DIP package with case, AM30-0505SNZ-L is SMD package without case, AM30-0505SNZ-LM is SMD package with case version).

Input Specification				
Parameters	Conditions	Typical	Maximum	Units
Voltage range	See models table			VDC
Filter	5V input models	LC filter		
	24V input models	Capacitor filter		
Absolute maximum rating	5V input models, 1 sec. max		16	VDC
	24V input models, 1 sec. max		50	VDC
Reflected ripple current	Nominal input voltage	100		mA pk-pk
Start-up voltage	5V input models		4.5	VDC
	24V input models		9	VDC
Under voltage protection	5V input models	2.5		VDC
	24V input models	5.5		VDC
Ctrl *	ON	Ctrl pin pulled low to GND(0~0.3VDC)		
	OFF	Ctrl pin open or pulled high(2~12VDC)		
	Shutdown current	5	10	mA

* The Ctrl pin voltage is referenced to input GND.

Isolation Specification				
Parameters	Conditions	Typical	Maximum	Units
Tested I/O, I/O to case voltage	60 sec, 5mA max	500		VAC
	60 sec, 1mA max	1500		VDC
Resistance	Resistance at 500VDC	\geq 100		M Ω
Capacitance	I/O capacitance at 100KHz/0.1V	1000		pF

Output Specification					
Parameters	Conditions	Typical	Maximum	Units	
Voltage accuracy	0 ~ 100% load	± 1	± 2	%	
Line regulation	Full load	± 0.2	± 0.5	%	
Load regulation	5 ~ 100% load		± 1	%	
Over voltage protection		110~160		% Vout	
Over current protection		160	110~250	% Iout	
Short circuit protection	Continuous, Auto recovery				
Temperature coefficient	Full load		± 0.03	%/°C	
Ripple & Noise*	20MHz bandwidth, 5 ~ 100% load	50	100	mV pk-pk	
Output voltage adjustment		±5		% Vout	
Transient recovery time	25% load step change	300	500	µS	
Transient response deviation	25% load step change	3.3V Vout models	±5	±10	%
		5V Vout models	±5	±8	%
		Others	±3	±5	%

* Ripple and Noise are measured at 20MHz bandwidth by using a 0.1µF (M/C) and 10µF (E/C) parallel capacitor and typical input with full load

General Specifications				
Parameters	Conditions	Typical	Maximum	Units
Switching frequency	PWM mode	330		KHz
Operating temperature	See derating graph	-40 to +85		°C
Storage temperature		-55 to +125		°C
Reflow soldering temperature	For SMD package only, peak temp ≤ 245°C, 60 sec max at 217°C, please refer to IPC/JEDEC J-STD-020D.1.			
Soldering temperature	Wave-soldering, 10 sec max		260	°C
	1.5mm from case, 10 sec max		300	°C
Cooling	Free air convection (20 LFM)			
Humidity	Non-condensing		95	% RH
Case material	Aluminum alloy(Optional -M and -LM models only)			
Vibration	10-150Hz, 5G, 90min. along X, Y and Z			
Shock	50G, 11ms once each along X, Y and Z axis			
Weight	Without case models	2.2		g
	With case models	3.5		
Dimensions (L x W x H)	DIP package without case models	0.95 x 0.59 x 0.24 inches, 24.00 x 15.10 x 6.19mm		
	DIP package with case models	0.98 x 0.65 x 0.27 inches, 25.00 x 16.40 x 6.80mm		
	SMD package without case models	1.03 x 0.59 x 0.24 inches, 26.20 x 15.10 x 6.19mm		
	SMD package with case models	1.03 x 0.65 x 0.27 inches, 26.20 x 16.40 x 6.80mm		
MTBF	> 1 000 000 hrs (MIL-HDBK -217F, t=+25°C) / Full Load			

Safety Specifications		
Parameters		
Agency approval	CE EN62368-1	
Standards	EMC - Conducted and radiated emission	CISPR32/EN55032, CLASS B with recommended circuit part B
	Electrostatic Discharge Immunity	IEC 61000-4-2, Contact ±6KV, Criteria B
	RF, Electromagnetic Field Immunity	IEC 61000-4-3, 10V/m, Criteria A
	Electrical Fast Transient/Burst Immunity	IEC 61000-4-4, ±2KV with recommended circuit part A, Criteria B
	Surge Immunity	IEC 61000-4-5, line to line ±2KV with recommended circuit part A, Criteria B
	RF, Conducted Disturbance Immunity	IEC 61000-4-6, 3 Vr.m.s, Criteria A

Note: It is suggested to connect the Y capacitor from case to input pin ground during EMC testing (with case models only)

Derating

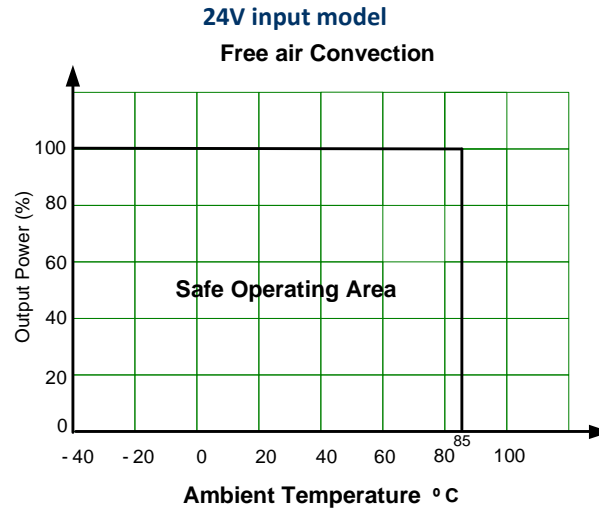
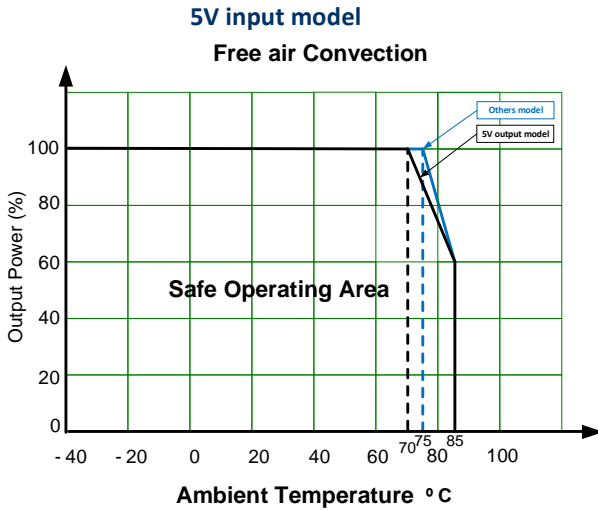

Typical Application Circuit

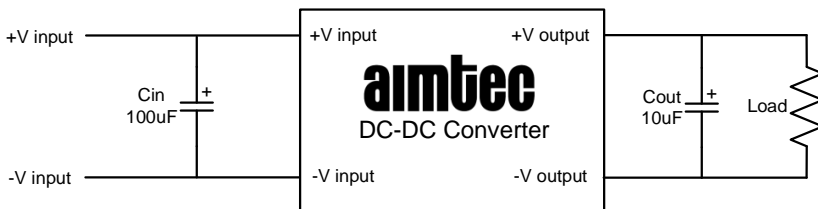

EMC Recommended Circuit

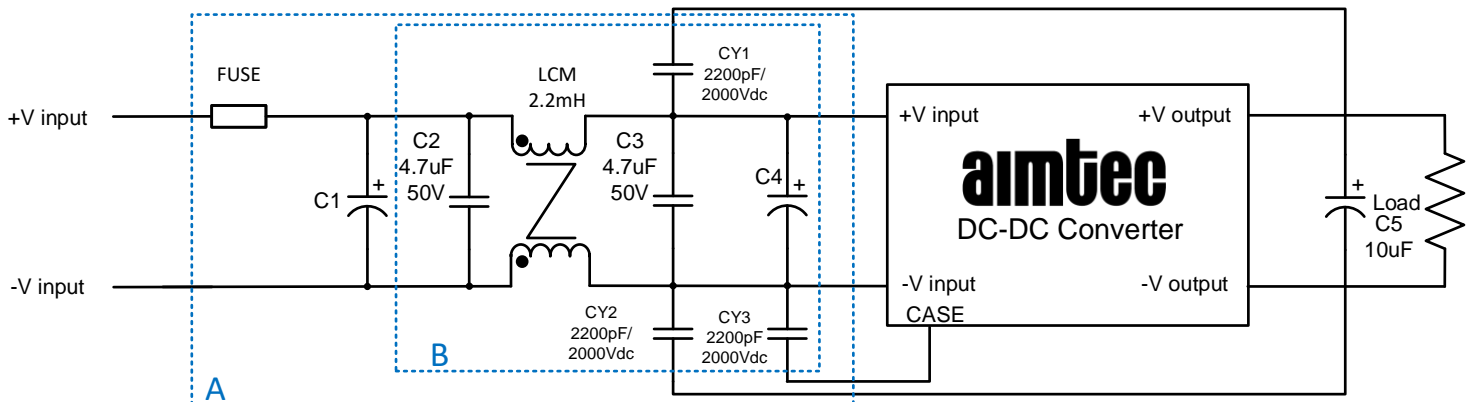

Fuse : Choose according to actual input current.

Note: The package with case model, the case should be connected the Y capacitor to input pin GND when testing EMC performance.

5V input models: C1:2200uF/35V, C4:100uF/50V

24V input models: C1:1000uF/50V, C4:220uF/50V

Dimensions

AM30- xxxx SNZ (DIP package without case)

Front View

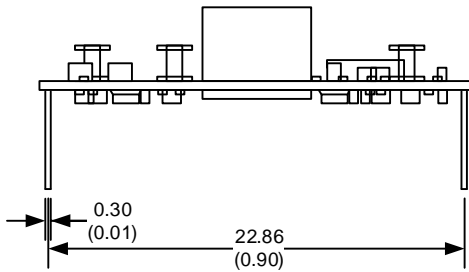

Right View

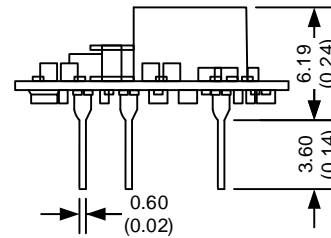

Bottom View

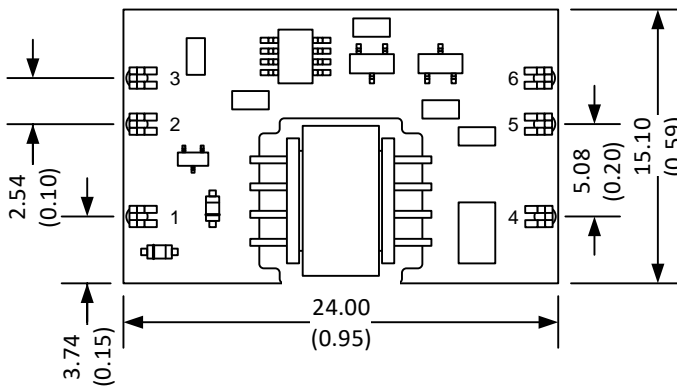

Notes:

All dimensions are typical in millimeters (inches).
Pin diameter tolerances : ± 0.1 (± 0.004)
Stand-off tolerance ± 0.50 (± 0.02)

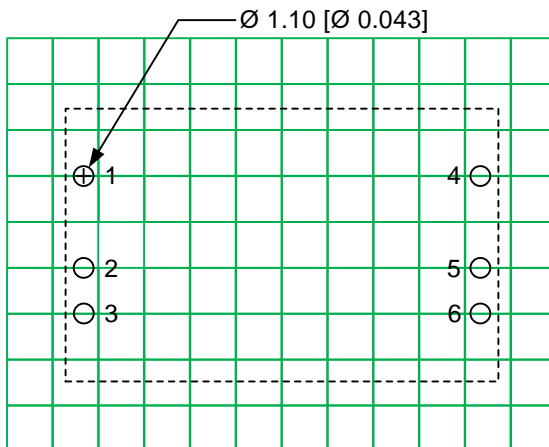

Note : Grid 2.54*2.54 mm

Pin Out Specifications

Pin	Single
1	+V Input
2	Ctrl
3	-V Input
4	+V Output
5	Trim
6	-V Output

AM30- xxxx SNZ-M (DIP package with case)

Front View

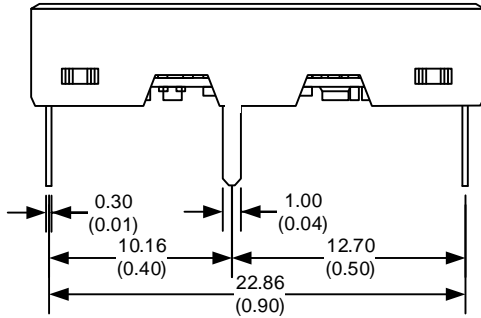

Right View

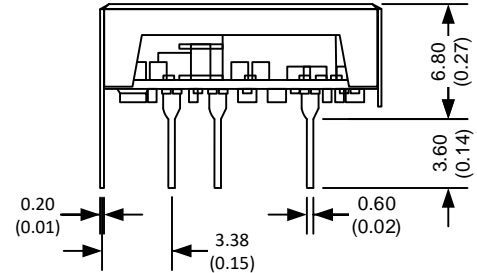

Bottom View

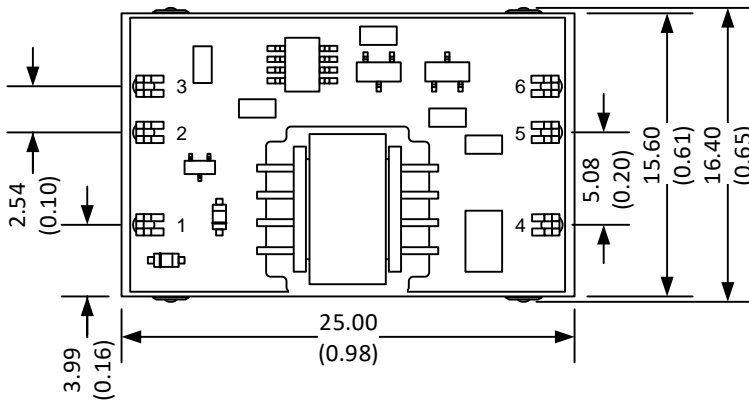

Notes:

All dimensions are typical in millimeters (inches).
Pin diameter tolerance : ± 0.1 (± 0.004)
Stand-off tolerance ± 0.50 (± 0.02)

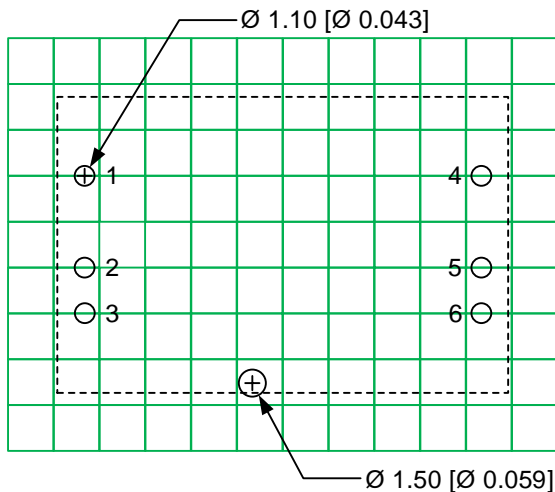

Note : Grid 2.54*2.54 mm

Pin Out Specifications

Pin	Single
1	+V Input
2	Ctrl
3	-V Input
4	+V Output
5	Trim
6	-V Output

AM30- xxxx SNZ-L (SMD package without case)

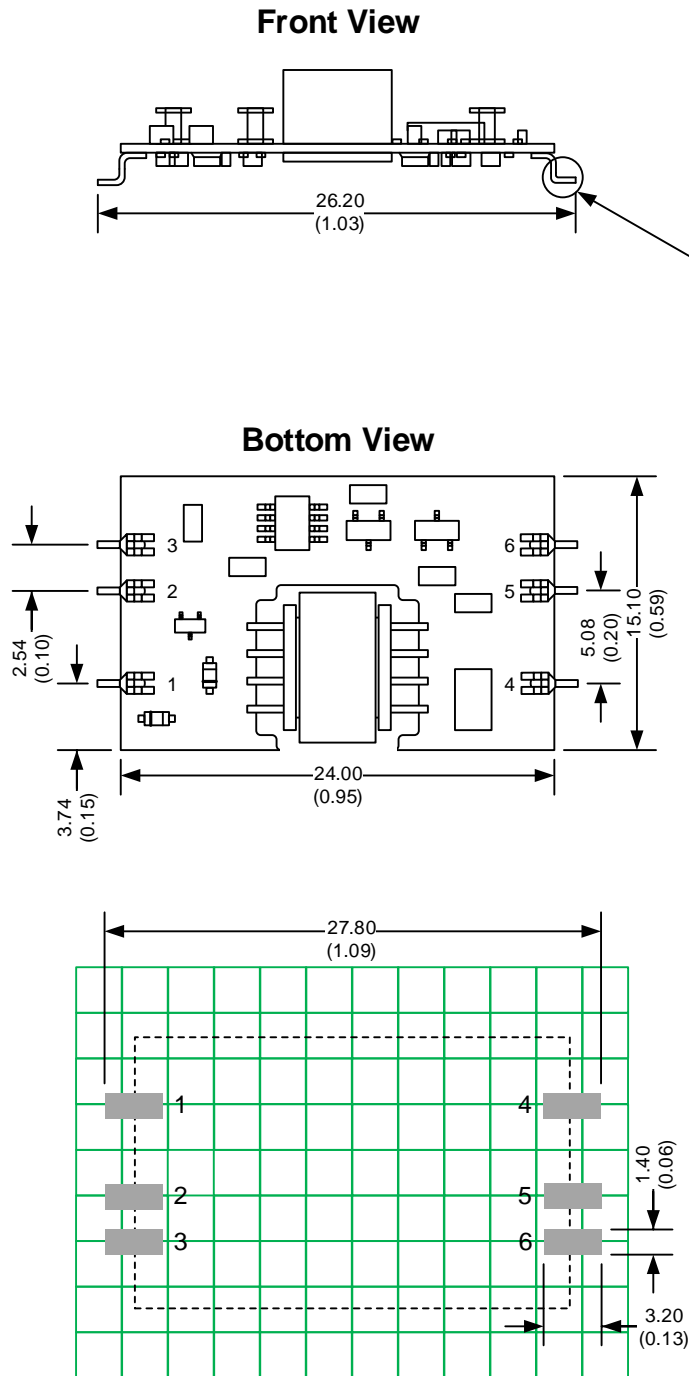

Notes:
 All dimensions are typical in millimeters (inches).
 Pin diameter tolerances : ± 0.1 (± 0.004)
 Stand-off tolerance ± 0.50 (± 0.02)

Pin Out Specifications	
Pin	Single
1	+V Input
2	Ctrl
3	-V Input
4	+V Output
5	Trim
6	-V Output

Note : Grid 2.54*2.54 mm

AM30- xxxx SNZ-LM (SMD package with case)

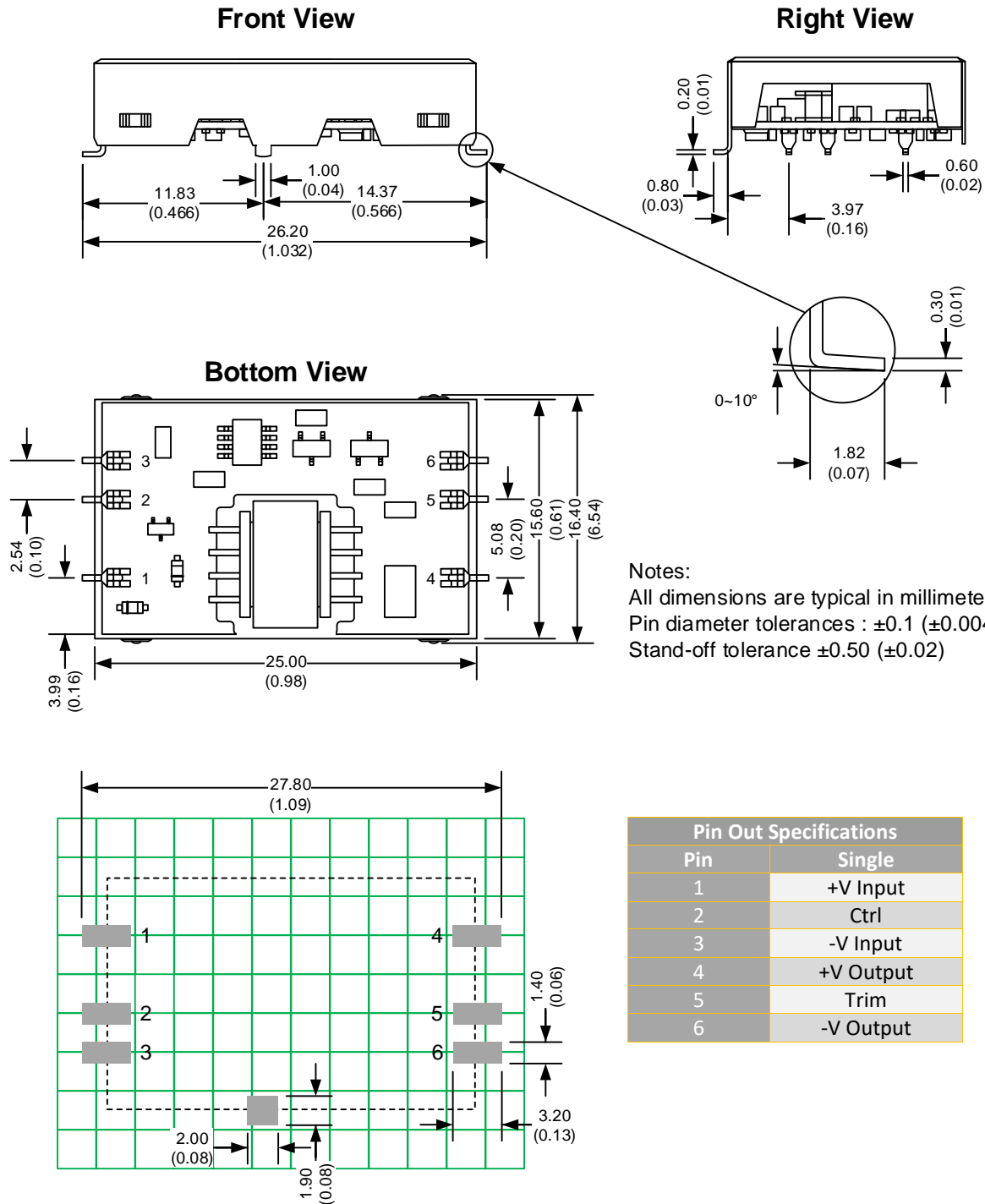

Notes:
 All dimensions are typical in millimeters (inches).
 Pin diameter tolerances : ± 0.1 (± 0.004)
 Stand-off tolerance ± 0.50 (± 0.02)

Pin Out Specifications	
Pin	Single
1	+V Input
2	Ctrl
3	-V Input
4	+V Output
5	Trim
6	-V Output

Note : Grid 2.54*2.54 mm

Trimming

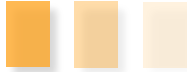

Output voltage can be externally trimmed by utilizing the methods as shown below

Fixed Resistor

Variable Potentiometer

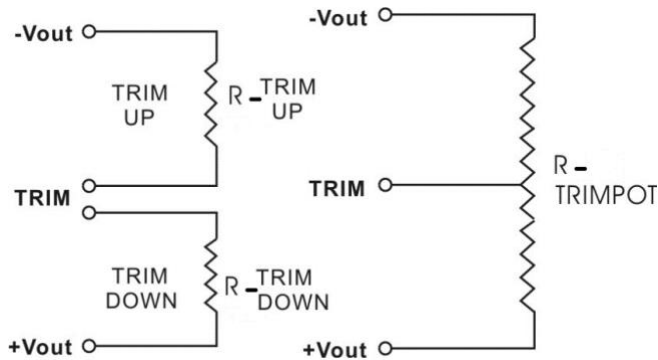

Leave open if not used.

3.3V output models

Trim down %	1	2	3	4	5
Vout (VDC)	3.267	3.234	3.201	3.168	3.135
Rt down (K Ω)	121.557	79.342	57.087	43.342	34.009
Trim up %	1	2	3	4	5
Vout (VDC)	3.342	3.366	3.399	3.432	3.465
Rt up (K Ω)	4252.376	226.149	92.726	55.640	38.229

5V output models

Trim down %	1	2	3	4	5
Vout (VDC)	4.950	4.900	4.850	4.800	4.750
Rt down (K Ω)	130.630	58.880	34.963	23.005	15.830
Trim up %	1	2	3	4	5
Vout (VDC)	5.050	5.100	5.150	5.200	5.250
Rt up (K Ω)	133.500	61.750	37.833	25.875	18.700

12V output models

Trim down %	1	2	3	4	5
Vout (VDC)	11.880	11.760	11.640	11.520	11.400
Rt down (K Ω)	813.735	399.920	259.338	188.540	145.897
Trim up %	1	2	3	4	5
Vout (VDC)	12.120	12.240	12.360	12.480	12.600
Rt up (K Ω)	219.089	100.320	61.504	42.238	30.724

15V output models

Trim down %	1	2	3	4	5
Vout (VDC)	14.850	14.700	14.550	14.400	14.250
Rt down (K Ω)	1166.483	568.567	369.261	269.608	209.817
Trim up %	1	2	3	4	5
Vout (VDC)	15.150	15.300	15.450	15.600	15.750
Rt up (K Ω)	224.167	104.583	64.722	44.792	32.833

24V output models

Trim down %	1	2	3	4	5
Vout (VDC)	23.760	23.520	23.280	23.040	22.800
Rt down (K Ω)	1645.641	917.947	628.702	473.386	376.466
Trim up %	1	2	3	4	5
Vout (VDC)	24.240	24.480	24.720	24.960	25.200
Rt up (K Ω)	361.706	136.129	78.855	52.703	37.726

NOTE: **1.** Datasheets are updated as needed and as such, specifications are subject to change without notice. Once printed or downloaded, datasheets are no longer controlled by Aimtec; refer to www.aimtec.com for the most current product specifications. **2.** Product labels shown, including safety agency certifications on labels, may vary based on the date manufactured. **3.** Mechanical drawings and specifications are for reference only. **4.** All specifications are measured at an ambient temperature of 25°C, humidity<75%, nominal input voltage and at rated output load unless otherwise specified. **5.** Aimtec may not have conducted destructive testing or chemical analysis on all internal components and chemicals at the time of publishing this document. CAS numbers and other limited information are considered proprietary and may not be available for release. **6.** This product is not designed for use in critical life support systems, equipment used in hazardous environments, nuclear control systems or other such applications which necessitate specific safety and regulatory standards other the ones listed in this datasheet. **7.** Warranty is in accordance with Aimtec's standard Terms of Sale available at www.aimtec.com.