

## Crystal Oscillator (SPXO)

- Package size (7.0 mm × 5.0 mm × 1.3 mm)
- Fundamental mode SPXO
- Output: CMOS
- Reference weight Typ.147 mg

### [ 1 ] Product Number / Product Name / Marking

(1-1) Product Number / Ordering Code

**X1G0044810008xx**

Last 2 digits code(xx) defines Quantity.

The standard is "00", 1 000 pcs/Reel.

(1-2) Product Name / Model Name

**SG7050CAN 20.000000 MHz TJGA**

### [ 2 ] Operating Range

Parameter	Symbol	Specifications			Unit	Conditions
		Min.	Typ.	Max.		
Supply voltage	V <sub>CC</sub>	1.60	-	3.63	V	-
	GND	0	-	0	V	-
Operating temperature range	T <sub>use</sub>	-40	-	+85	°C	-
CMOS load condition	L <sub>CMOS</sub>	-	-	15	pF	-

### [ 3 ] Frequency Characteristics

(Unless stated otherwise [ 3 ] Operating Range)

Parameter	Symbol	Specifications			Unit	Conditions
		Min.	Typ.	Max.		
Output frequency	f <sub>o</sub>	-	20.000000	-	MHz	-
Frequency tolerance *1	f <sub>tol</sub>	-50	-	+50	×10 <sup>-6</sup>	T <sub>use</sub>
Frequency aging	f <sub>age</sub>	-3	-	+3	×10 <sup>-6</sup>	+25 °C, First year

\*1 Frequency tolerance includes initial frequency tolerance, temperature variation, supply voltage change and load drift.

### [ 4 ] Electrical Characteristics

(Unless stated otherwise [ 3 ] Operating Range)

Parameter	Symbol	Specifications			Unit	Conditions
		Min.	Typ.	Max.		
Start-up time	t <sub>str</sub>	-	-	3.0	ms	t = 0 at 90 % V <sub>CC</sub>
Current consumption	I <sub>CC</sub>	-	-	1.8	mA	No load condition, V <sub>CC</sub> = 3.3 V
Stand-by current	I <sub>std</sub>	-	-	2.7	μA	$\overline{ST}$ = GND, V <sub>CC</sub> = 3.3 V
Output voltage	V <sub>OH</sub>	90 % V <sub>CC</sub>	-	-	V	I <sub>OH</sub> = -4 mA @V <sub>CC</sub> = 3.3 V
	V <sub>OL</sub>	-	-	10 % V <sub>CC</sub>	V	I <sub>OL</sub> = 4 mA @V <sub>CC</sub> = 3.3 V
Rise time	t <sub>r</sub>	-	-	3.5	ns	20 % V <sub>CC</sub> to 80 % V <sub>CC</sub> Level, L <sub>CMOS</sub> = 15 pF, V <sub>CC</sub> = 1.8 V ± 10 %
Fall time	t <sub>f</sub>	-	-	3.5	ns	80 % V <sub>CC</sub> to 20 % V <sub>CC</sub> Level, L <sub>CMOS</sub> = 15 pF, V <sub>CC</sub> = 1.8 V ± 10 %
Symmetry	SYM	45	-	55	%	50 % V <sub>CC</sub> Level, L <sub>CMOS</sub> ≤ 15 pF
Input voltage	V <sub>IH</sub>	80 % V <sub>CC</sub>	-	-	V	$\overline{ST}$ terminal
	V <sub>IL</sub>	-	-	20 % V <sub>CC</sub>	V	$\overline{ST}$ terminal
Output disable time (ST)	t <sub>stp_st</sub>	-	-	100	ns	$\overline{ST}$ terminal HIGH → LOW
Output enable time (ST)	t <sub>sta_st</sub>	-	-	3	ms	$\overline{ST}$ terminal LOW → HIGH

[ For other general specifications, please refer to the attached Full Data Sheet below ]

# Crystal oscillator: SG2016 / 3225 / 5032 / 7050CAN & SG-210STF

## Features

- Crystal oscillator (SPXO)
- Frequency: 20 standard frequencies (4 MHz to 72 MHz)
- Output: CMOS
- Supply voltage: 1.6 V to 3.63 V
- Operating temperature: -20 °C to +70 °C  
-40 °C to +105 °C

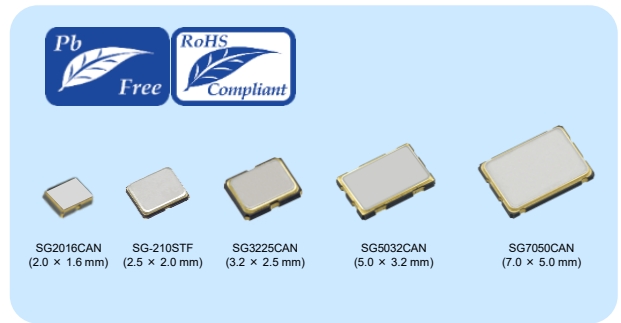

## Applications

- IoT, Wearable device
- Data center, Storage
- Medical, Industrial automation

## Description

Epson's SGxxxxCAN & SG-210STF are Simple Packaged Crystal Oscillator (SPXO) series with CMOS output. These SPXO's are ideal for variety of applications from IoT, wearables, medical, industrial automation, etc. These SPXO have low current consumption, wide operating voltage from 1.6 V to 3.63 V and wide operating temperature range from -40 °C to 85 °C, in addition operation up to 105 °C is available. These SPXO's are available in five different package size from 2.0 × 1.6 mm to 7.0 × 5.0 mm and available in standard pin out's.

## Outline Drawing and Terminal Assignment

SG2016CAN

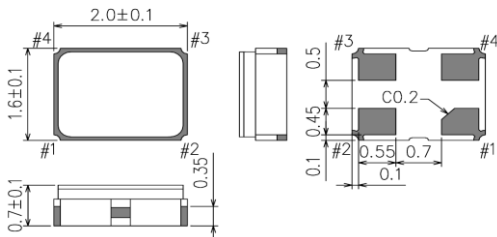

SG-210STF

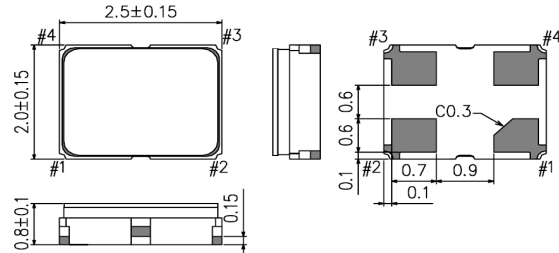

SG3225CAN

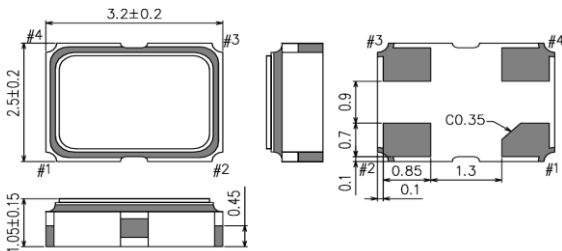

SG5032CAN

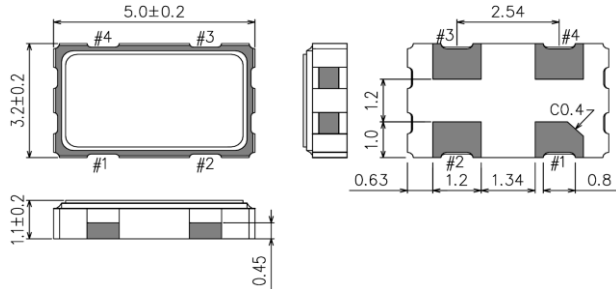

SG7050CAN

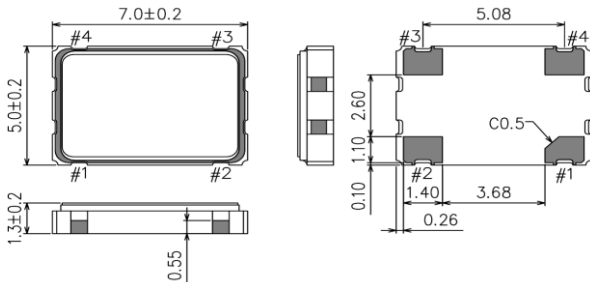

## Terminal Assignment

Pin #	Connection	Function	
		ST function	Output
#1	ST	ST terminal	
		"H" or OPEN	Oscillation
		"L"	Oscillation stop
#2	GND	GND terminal	
#3	OUT	Output terminal	
#4	V <sub>CC</sub>	V <sub>CC</sub> terminal	

## [ 1 ] Product Name / Product Number

(1-1) SG2016CAN

(1) Product Name (Standard Form)

SG2016 CAN 25.000000MHz I J H A  
 ① ② ③ ④⑤⑥⑦

①Model ②Output (C:CMOS) ③Frequency ④Supply voltage

⑤Frequency tolerance ⑥Operating temperature ⑦Internal identification code ("A" is default)

④Supply voltage Refer to Figure 1	
T	1.8 V to 3.3 V Typ.
K	2.5 V to 3.3 V Typ.

\*Figure 1 is on the next page

⑤Frequency tolerance / ⑥Operating temperature	
DB	$\pm 25 \times 10^{-6}$ / -20 °C to +70 °C
JG	$\pm 50 \times 10^{-6}$ / -40 °C to +85 °C
JH	$\pm 50 \times 10^{-6}$ / -40 °C to +105 °C

(2) Product Number / Ordering Code

Frequency [MHz]	Frequency tolerance / Operating temperature		
	DB	JG	JH
	$\pm 25 \times 10^{-6}$ -20 °C to +70 °C	$\pm 50 \times 10^{-6}$ -40 °C to +85 °C	$\pm 50 \times 10^{-6}$ -40 °C to +105 °C
4	-	X1G004801003000	X1G004801004900
8	-	X1G004801004500	X1G004801004600
10	-	X1G004801002900	X1G004801002700
12	X1G004801005000	X1G004801000700	X1G004801005100
12.288	X1G004801005200	X1G004801004400	X1G004801005300
14.7456	-	X1G004801005400	X1G004801005500
16	-	X1G004801001400	X1G004801005600
20	X1G004801005700	X1G004801005800	X1G004801001800
24	X1G004801005900	X1G004801000200	X1G004801004000
24.576	-	X1G004801006000	X1G004801003100
25	X1G004801002400	X1G004801001200	X1G004801003500
26	-	X1G004801000300	X1G004801003900
27	-	X1G004801006100	X1G004801002100
32	-	X1G004801006200	X1G004801006300
33.33	-	X1G004801006400	X1G004801006500
33.3333	-	X1G004801002600	X1G004801006600
40	-	X1G004801006700	X1G004801003600
48	X1G004801006800	X1G004801002000	X1G004801006900
50	X1G004801007000	X1G004801001300	X1G004801002800
72	X1G004801007100	X1G004801007200	X1G004801007300

## (1-2) SG-210STF

## (1) Product Name (Standard Form)

SG-210 S T F 25.000000 MHz Y

①

②③

④

⑤

①Model ②Function (S:Standby) ③Supply voltage

④Frequency ⑤Frequency tolerance / Operating temperature

③Supply voltage Refer to Figure 1	
T	1.8 V to 3.3 V Typ.

\*Figure 1 is on the next page

⑤Frequency tolerance / Operating temperature	
S	$\pm 25 \times 10^{-6}$ / -20 °C to +70 °C
L	$\pm 50 \times 10^{-6}$ / -40 °C to +85 °C
Y	$\pm 50 \times 10^{-6}$ / -40 °C to +105 °C

## (2) Product Number / Ordering Code

Frequency [MHz]	Frequency tolerance / Operating temperature		
	S	L	Y
	$\pm 25 \times 10^{-6}$ -20 °C to +70 °C	$\pm 50 \times 10^{-6}$ -40 °C to +85 °C	$\pm 50 \times 10^{-6}$ -40 °C to +105 °C
4	-	X1G004171000900	X1G004171029900
8	-	X1G004171001500	X1G004171006900
10	-	X1G004171001600	X1G004171036500
12	X1G004171016300	X1G004171001800	X1G004171028000
12.288	X1G004171006100	X1G004171001900	X1G004171036600
14.7456	-	X1G004171002500	X1G004171036700
16	-	X1G004171002700	X1G004171015400
20	X1G004171021800	X1G004171002900	X1G004171023800
24	X1G004171015600	X1G004171003100	X1G004171019700
24.576	-	X1G004171003200	X1G004171036800
25	X1G004171007700	X1G004171003300	X1G004171005900
26	-	X1G004171003400	X1G004171024400
27	-	X1G004171003500	X1G004171025000
32	-	X1G004171004000	X1G004171012700
33.33	-	X1G004171011900	X1G004171030000
33.3333	-	X1G004171012000	X1G004171007500
40	-	X1G004171004500	X1G004171020600
48	X1G004171007800	X1G004171004600	X1G004171036900
50	X1G004171007900	X1G004171004700	X1G004171012600
72	X1G004171037000	X1G004171012400	X1G004171037100

## (1-3) SG3225CAN

## (1) Product Name (Standard Form)

SG3225 CAN 25.000000 MHz I J H A

① ② ③ ④⑤⑥⑦

①Model ②Output (C:CMOS) ③Frequency ④Supply voltage

⑤Frequency tolerance ⑥Operating temperature ⑦Internal identification code ("A" is default)

④Supply voltage Refer to Figure 1	
T	1.8 V to 3.3 V Typ.
K	2.5 V to 3.3 V Typ.

\*Figure 1 is on the next page

⑤Frequency tolerance / ⑥Operating temperature	
DB	$\pm 25 \times 10^{-6}$ / -20 °C to +70 °C
JG	$\pm 50 \times 10^{-6}$ / -40 °C to +85 °C
JH	$\pm 50 \times 10^{-6}$ / -40 °C to +105 °C

## (2) Product Number / Ordering Code

Frequency [MHz]	Frequency tolerance / Operating temperature		
	DB	JG	JH
	$\pm 25 \times 10^{-6}$ -20 °C to +70 °C	$\pm 50 \times 10^{-6}$ -40 °C to +85 °C	$\pm 50 \times 10^{-6}$ -40 °C to +105 °C
4	-	X1G005961001115	X1G005961001215
8	-	X1G005961000415	X1G005961001315
10	-	X1G005961000515	X1G005961001415
12	X1G005961001515	X1G005961000615	X1G005961001615
12.288	X1G005961001715	X1G005961001815	X1G005961001915
14.7456	-	X1G005961002015	X1G005961002115
16	-	X1G005961002215	X1G005961002315
20	X1G005961002415	X1G005961000715	X1G005961002515
24	X1G005961002615	X1G005961000115	X1G005961002715
24.576	-	X1G005961000815	X1G005961002815
25	X1G005961002915	X1G005961000215	X1G005961003015
26	-	X1G005961003115	X1G005961003215
27	-	X1G005961003315	X1G005961003415
32	-	X1G005961003515	X1G005961003615
33.33	-	X1G005961003715	X1G005961003815
33.3333	-	X1G005961003915	X1G005961004015
40	-	X1G005961000915	X1G005961004115
48	X1G005961004215	X1G005961000315	X1G005961004315
50	X1G005961004415	X1G005961001015	X1G005961004515
72	X1G005961004615	X1G005961004715	X1G005961004815

(1-4) SG5032CAN

(1) Product Name (Standard Form)

SG5032 CAN 25.000000 MHz I J H A

① ② ③ ④⑤⑥⑦

①Model ②Output (C:CMOS) ③Frequency ④Supply voltage

⑤Frequency tolerance ⑥Operating temperature ⑦Internal identification code ("A" is default)

④Supply voltage Refer to Figure 1	
T	1.8 V to 3.3 V Typ.
K	2.5 V to 3.3 V Typ.

\*Figure 1 is on the next page

⑤Frequency tolerance / ⑥Operating temperature	
DB	$\pm 25 \times 10^{-6}$ / -20 °C to +70 °C
JG	$\pm 50 \times 10^{-6}$ / -40 °C to +85 °C
JH	$\pm 50 \times 10^{-6}$ / -40 °C to +105 °C

(2) Product Number / Ordering Code

Frequency [MHz]	Frequency tolerance / Operating temperature		
	DB	JG	JH
	$\pm 25 \times 10^{-6}$ -20 °C to +70 °C	$\pm 50 \times 10^{-6}$ -40 °C to +85 °C	$\pm 50 \times 10^{-6}$ -40 °C to +105 °C
4	-	X1G004451003400	X1G004451019600
8	-	X1G004451002100	X1G004451019700
10	-	X1G004451001300	X1G004451017800
12	X1G004451019800	X1G004451002800	X1G004451019900
12.288	X1G004451020000	X1G004451000100	X1G004451020100
14.7456	-	X1G004451001900	X1G004451020200
16	-	X1G004451000200	X1G004451020300
20	X1G004451020400	X1G004451001100	X1G004451020500
24	X1G004451017200	X1G004451000300	X1G004451020600
24.576	-	X1G004451002900	X1G004451020700
25	X1G004451009700	X1G004451000400	X1G004451020800
26	-	X1G004451008200	X1G004451020900
27	-	X1G004451000500	X1G004451021000
32	-	X1G004451001400	X1G004451021100
33.33	-	X1G004451021200	X1G004451021300
33.3333	-	X1G004451016700	X1G004451021400
40	-	X1G004451001200	X1G004451021500
48	X1G004451014900	X1G004451000700	X1G004451011200
50	X1G004451011500	X1G004451000800	X1G004451003600
72	X1G004451021600	X1G004451021700	X1G004451021800

## (1-5) SG7050CAN

## (1) Product Name (Standard Form)

SG7050 CAN 25.000000 MHz I J H A

① ② ③ ④⑤⑥⑦

①Model ②Output (C:CMOS) ③Frequency ④Supply voltage

⑤Frequency tolerance ⑥Operating temperature ⑦Internal identification code ("A" is default)

④Supply voltage Refer to Figure 1	
T	1.8 V to 3.3 V Typ.
K	2.5 V to 3.3 V Typ.

\*Figure 1 is on the next page

⑤Frequency tolerance / ⑥Operating temperature	
DB	$\pm 25 \times 10^{-6}$ / -20 °C to +70 °C
JG	$\pm 50 \times 10^{-6}$ / -40 °C to +85 °C
JH	$\pm 50 \times 10^{-6}$ / -40 °C to +105 °C

## (2) Product Number / Ordering Code

Frequency [MHz]	Frequency tolerance / Operating temperature		
	DB	JG	JH
	$\pm 25 \times 10^{-6}$ -20 °C to +70 °C	$\pm 50 \times 10^{-6}$ -40 °C to +85 °C	$\pm 50 \times 10^{-6}$ -40 °C to +105 °C
4	-	X1G004481005100	X1G004481025200
8	-	X1G004481001400	X1G004481025300
10	-	X1G004481000500	X1G004481025400
12	X1G004481025500	X1G004481000600	X1G004481025600
12.288	X1G004481025700	X1G004481000100	X1G004481025800
14.7456	-	X1G004481002500	X1G004481025900
16	-	X1G004481000700	X1G004481026000
20	X1G004481012800	X1G004481000800	X1G004481026100
24	X1G004481002200	X1G004481000200	X1G004481026200
24.576	-	X1G004481001600	X1G004481026300
25	X1G004481011600	X1G004481000300	X1G004481026400
26	-	X1G004481003500	X1G004481026500
27	-	X1G004481000400	X1G004481026600
32	-	X1G004481000900	X1G004481026700
33.33	-	X1G004481017900	X1G004481026800
33.3333	-	X1G004481003300	X1G004481026900
40	-	X1G004481001500	X1G004481027000
48	X1G004481022600	X1G004481001100	X1G004481027100
50	X1G004481011200	X1G004481001200	X1G004481016000
72	X1G004481027200	X1G004481018300	X1G004481027300

## [ 2 ] Absolute Maximum Ratings

Parameter	Symbol	Specification			Unit	Conditions
		Min.	Typ.	Max.		
Maximum supply voltage	$V_{CC}$	-0.3	-	4	V	
Input voltage	$V_{in}$	-0.3	-	$V_{CC} + 0.3$	V	ST terminal
Storage temperature range	$T_{stg}$	-55	-	+125	°C	SG2016CAN, SG3225CAN
		-40	-	+125	°C	All other

## [ 3 ] Operating Range

Parameter	Symbol	Specification			Unit	Conditions
		Min.	Typ.	Max.		
Supply voltage	$V_{CC}$	1.6	-	3.63	V	$f_o \leq 50$ MHz, $T_{use} = +105$ °C Max.
		1.71	-	3.63	V	$f_o = 72$ MHz, $T_{use} = +85$ °C Max.
		2.25	-	3.63	V	$f_o = 72$ MHz, $T_{use} = +105$ °C Max.
Supply voltage	GND	0.0	0.0	0.0	V	
Operating temperature range (Refer to Figure 1)	$T_{use}$	-20	+25	+70	°C	
		-40	+25	+85	°C	
		-40	+25	+105	°C	
CMOS load condition	$L_{CMOS}$	-	-	15	pF	

\* Power supply startup time ( $0\%V_{CC} \rightarrow 90\%V_{CC}$ ) should be more than 150  $\mu$ s

\* A 0.01  $\mu$ F to a 0.1  $\mu$ F bypass capacitor should be connected between  $V_{CC}$  and GND pins located close to the device



Figure 1: The upper limit of Operating temperature and the related conditions

Please note that Supply voltage range ( $V_{CC}$ ) depends on Output frequency( $f_o$ ) and upper limit of Operating temperature( $T_{use}$  Max.).

## [ 4 ] Frequency Characteristics

(Unless stated otherwise [ 3 ] Operating Range)

Parameter	Symbol	Specification			Unit	Conditions
		Min.	Typ.	Max.		
Output frequency	$f_o$	4, 8, 10, 12, 12.288, 14.7456, 16, 20, 24, 24.576, 25, 26, 27, 32, 33.33, 33.3333, 40, 48, 50, 72			MHz	
Frequency tolerance *1	$f_{tol}$	-25	-	+25	$\times 10^{-6}$	$T_{use} = -20$ °C to +70 °C
		-50	-	+50	$\times 10^{-6}$	$T_{use} = -40$ °C to +105 °C $T_{use} = -40$ °C to +85 °C *2
Frequency aging	$f_{age}$	-3		+3	$\times 10^{-6}$	$T_{use} = +25$ °C, First year

\*1 Frequency tolerance includes initial frequency tolerance, frequency / temperature characteristics, frequency / voltage coefficient, and frequency / load coefficient

\*2 This temperature range is only for  $f_o = 72$  MHz



## [ 5 ] Electrical Characteristics

(Unless stated otherwise [ 3 ] Operating Range)

Parameter	Symbol	Specification			Unit	Conditions
		Min.	Typ.	Max.		
Start-up time	t_str	-	-	3	ms	t = 0 at 90%V <sub>CC</sub>
Current consumption (No load) V <sub>CC</sub> = 1.8 V ± 10 %	I <sub>CC</sub>	-	-	1.5	mA	4 MHz ≤ f <sub>o</sub> ≤ 20 MHz
		-	-	1.8	mA	20 MHz < f <sub>o</sub> ≤ 40 MHz
		-	-	2.1	mA	40 MHz < f <sub>o</sub> ≤ 50 MHz
V <sub>CC</sub> = 1.8 V ± 5 %		-	-	2.4	mA	f <sub>o</sub> = 72 MHz
Current consumption (No load) V <sub>CC</sub> = 2.5 V ± 10 %		-	-	1.6	mA	4 MHz ≤ f <sub>o</sub> ≤ 20 MHz
		-	-	2.0	mA	20 MHz < f <sub>o</sub> ≤ 40 MHz
		-	-	2.4	mA	40 MHz < f <sub>o</sub> ≤ 50 MHz
Current consumption (No load) V <sub>CC</sub> = 3.3 V ± 10 %		-	-	2.8	mA	f <sub>o</sub> = 72 MHz
		-	-	1.8	mA	4 MHz ≤ f <sub>o</sub> ≤ 20 MHz
	-	-	2.2	mA	20 MHz < f <sub>o</sub> ≤ 40 MHz	
Stand-by current	I_std	-	-	2.1	μA	V <sub>CC</sub> = 1.8 V ± 10 % or ± 5 %, ST = GND
		-	-	2.5	μA	V <sub>CC</sub> = 2.5 V ± 10 %, ST = GND
		-	-	2.7	μA	V <sub>CC</sub> = 3.3 V ± 10 %, ST = GND
Output voltage	V <sub>OH</sub>	90 % V <sub>CC</sub>	-	-	V	Load current condition 1.8 V ± 10 %   2.5 V ± 10 %   3.3 V ± 10 % I <sub>OH</sub> -1.5 mA -3 mA -4 mA I <sub>OL</sub> 1.5 mA 3 mA 4 mA
	V <sub>OL</sub>	-	-	10 % V <sub>CC</sub>	V	
	V <sub>OH</sub>	V <sub>CC</sub> - 0.4	-	-	V	Load current condition 1.8 V ± 10 %   2.5 V ± 10 %   3.3 V ± 10 % I <sub>OH</sub> -3 mA -4 mA -6 mA I <sub>OL</sub> 3 mA 4 mA 6 mA
	V <sub>OL</sub>	-	-	0.4	V	
Symmetry	SYM	45	50	55	%	50 % V <sub>CC</sub> level, L_CMOS ≤ 15 pF
Rise time/Fall time	tr / tf	-	-	3	ns	V <sub>CC</sub> = 2.5 V or 3.3 V ± 10 %, 20 % V <sub>CC</sub> to 80 % V <sub>CC</sub> Level, L_CMOS = 15 pF
		-	-	3.5	ns	V <sub>CC</sub> = 1.8 V ± 10 % or ± 5 %, 20 % V <sub>CC</sub> to 80 % V <sub>CC</sub> Level, L_CMOS = 15 pF
Input voltage	V <sub>IH</sub>	80 % V <sub>CC</sub>	-	-	V	ST terminal
	V <sub>IL</sub>	-	-	20 % V <sub>CC</sub>	V	
Output disable time (ST)	tstp_st	-	-	100	ns	ST terminal HIGH → LOW
Output enable time (ST)	tsta_st	-	-	3	ms	ST terminal LOW → HIGH

## [ 6 ] Thermal resistance (For reference only)

Parameter	Symbol	Specification			Unit	Conditions
		Min.	Typ.	Max.		
Junction temperature	T <sub>j</sub>	-	-	+125	°C	
Junction to case	θ <sub>jc</sub>	-	9.8	-	°C/W	SG2016CAN
		-	15.2	-	°C/W	SG-210STF
		-	23.1	-	°C/W	SG3225CAN
		-	16.1	-	°C/W	SG5032CAN
		-	28.0	-	°C/W	SG7050CAN
Junction to ambient	θ <sub>ja</sub>	-	99.6	-	°C/W	SG2016CAN
		-	91.9	-	°C/W	SG-210STF
		-	103.8	-	°C/W	SG3225CAN
		-	82.5	-	°C/W	SG5032CAN
		-	78.8	-	°C/W	SG7050CAN

[ 7 ] Typical Performance Characteristics (For reference only)

The following data shows typical performance characteristics

(7-1) Frequency / Temperature Characteristics

$f_0 = 25 \text{ MHz}$ ,  $\pm 25 \times 10^{-6}$  at  $-20 \text{ }^\circ\text{C}$  to  $+70 \text{ }^\circ\text{C}$

n = 50 pcs

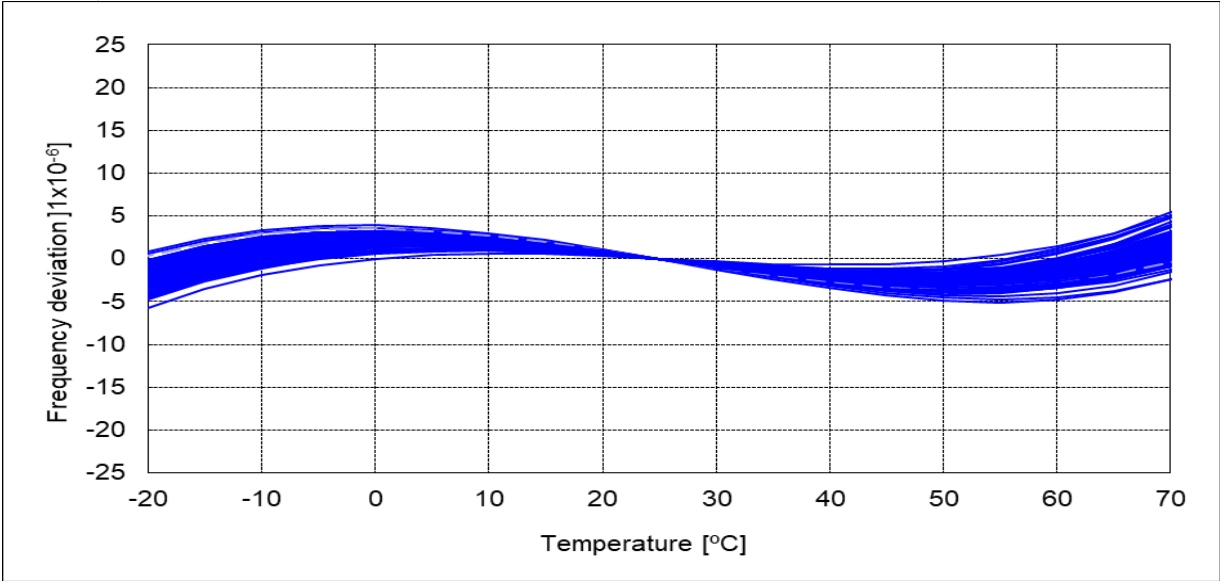

$f_0 = 25 \text{ MHz}$ ,  $\pm 50 \times 10^{-6}$  at  $-40 \text{ }^\circ\text{C}$  to  $+85 \text{ }^\circ\text{C}/+105 \text{ }^\circ\text{C}$

n = 50 pcs

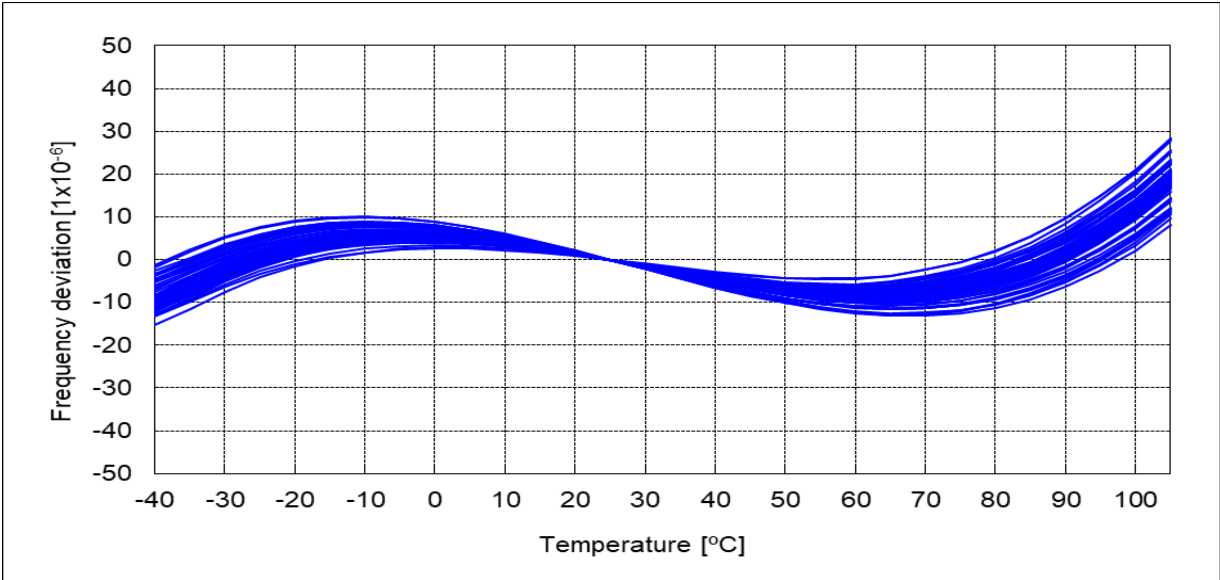

(7-2) Current Consumption

No load,  $T_{use} = +25\text{ }^{\circ}\text{C}$ , Freq. Dependency



$L_{CMOS} = 15\text{ pF}$ ,  $T_{use} = +25\text{ }^{\circ}\text{C}$ , Freq. Dependency



$f_o = 20\text{ MHz}$

$L_{CMOS} = 5\text{ pF}$ , Temperature Characteristic

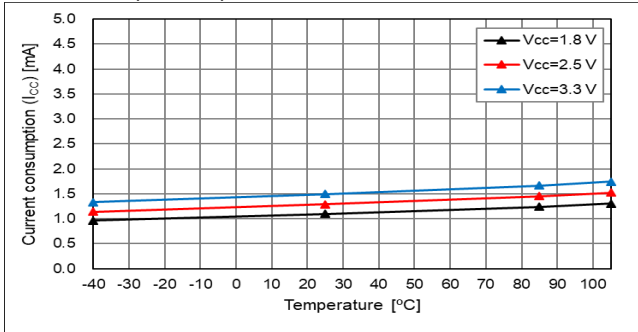

$T_{use} = +25\text{ }^{\circ}\text{C}$ , Output load( $L_{CMOS}$ ) Characteristics

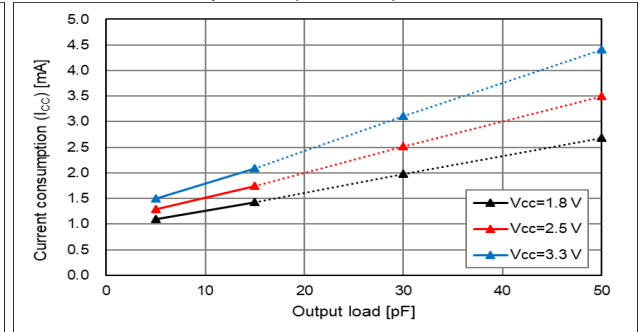

$f_o = 40\text{ MHz}$

$L_{CMOS} = 5\text{ pF}$ , Temperature Characteristic



$T_{use} = +25\text{ }^{\circ}\text{C}$ , Output load( $L_{CMOS}$ ) Characteristics



$f_o = 72\text{ MHz}$

$L_{CMOS} = 5\text{ pF}$ , Temperature Characteristic

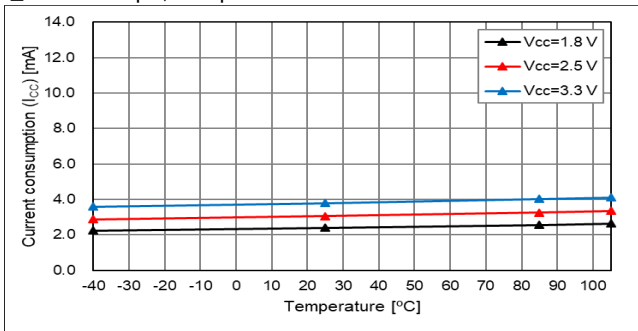

$T_{use} = +25\text{ }^{\circ}\text{C}$ , Output load( $L_{CMOS}$ ) Characteristics

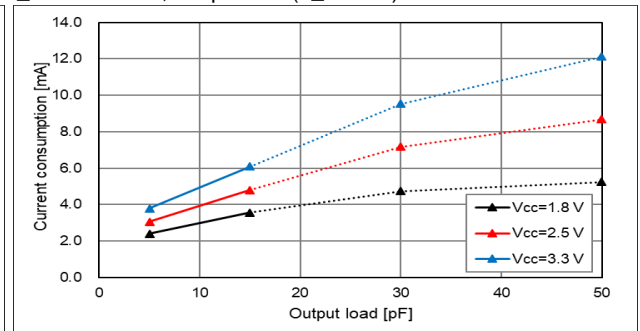

\* Output load condition under  $L_{CMOS} > 15\text{ pF}$  (dotted line area) is not guaranteed, and the data is for reference.

The actual current consumption is the total of the current under the condition of no load and the current to drive the output load ( $f_o \times L_{CMOS} \times V_{CC}$ ). To reduce the current consumption, it is effective to use lower frequency, lower supply voltage and lower output load.

(7-3) Rise Time / Fall Time

fo = 20 MHz, Rise Time

20% - 80% V<sub>CC</sub>, L<sub>CMOS</sub> = 15 pF, Temp. Char.

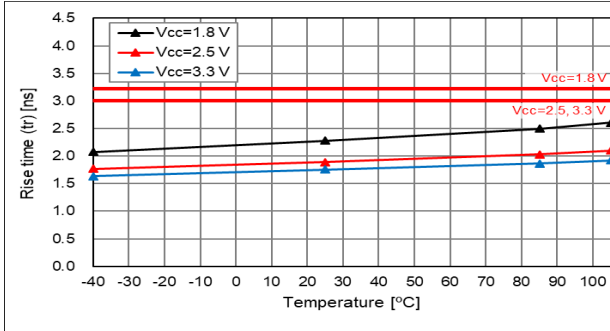

20% - 80% V<sub>CC</sub>, T<sub>use</sub> = +25 °C, Output load Char.

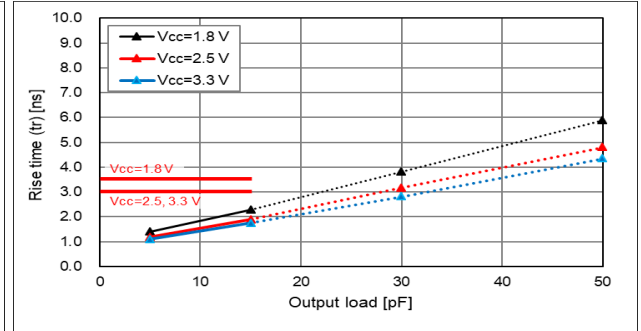

10% - 90% V<sub>CC</sub>, L<sub>CMOS</sub> = 15 pF, Temp. Char.

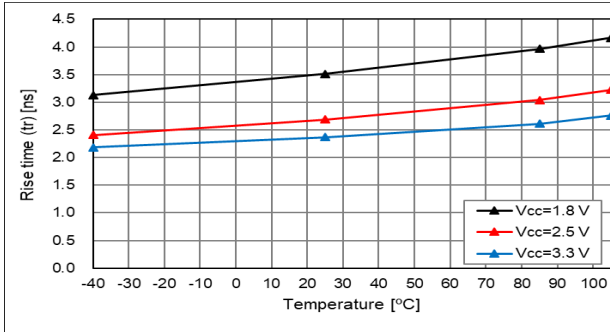

10% - 90% V<sub>CC</sub>, T<sub>use</sub> = +25 °C, Output load Char.

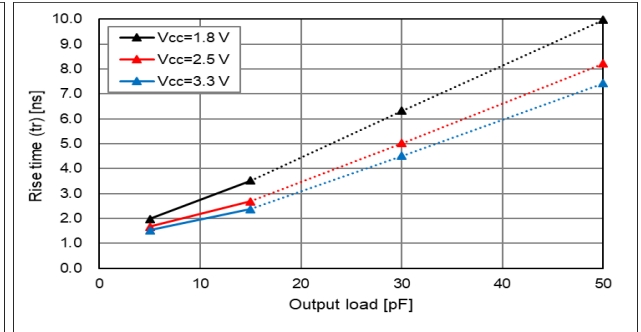

\* Output load condition under L<sub>CMOS</sub> > 15 pF (dotted line area) is not guaranteed, and the data is for reference.

fo = 20 MHz, Fall Time

20% - 80% V<sub>CC</sub>, L<sub>CMOS</sub> = 15 pF, Temp. Char.

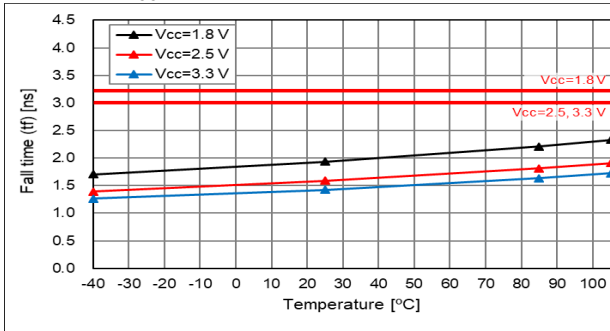

20% - 80% V<sub>CC</sub>, T<sub>use</sub> = +25 °C, Output load Char.

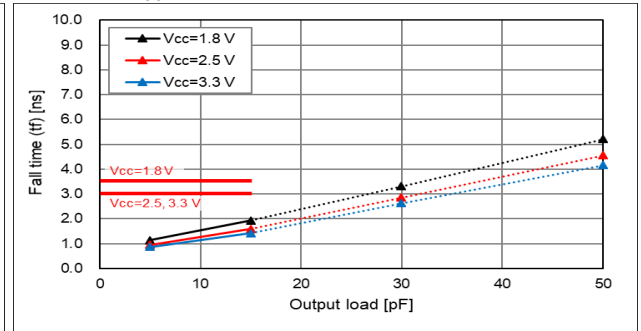

10% - 90% V<sub>CC</sub>, L<sub>CMOS</sub> = 15 pF, Temp. Char.

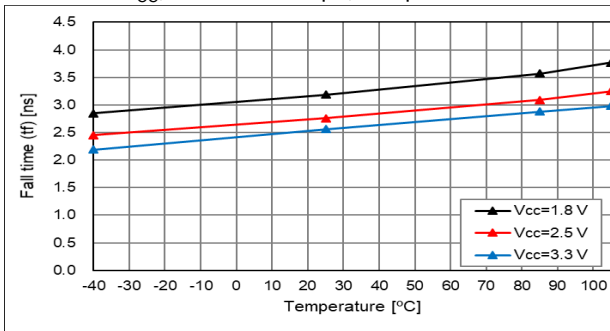

10% - 90% V<sub>CC</sub>, T<sub>use</sub> = +25 °C, Output load Char.

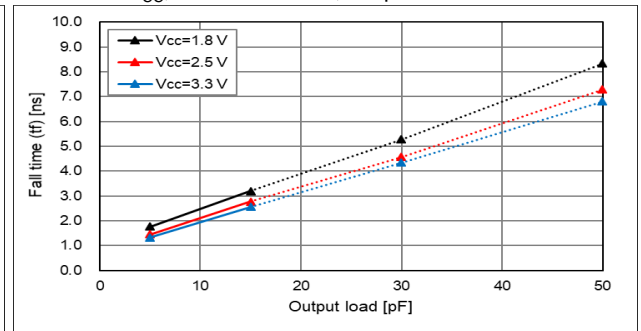

\* Output load condition under L<sub>CMOS</sub> > 15 pF (dotted line area) is not guaranteed, and the data is for reference.

(7-3) Rise Time / Fall Time [cont'd]

fo = 40 MHz, Rise Time

20% - 80% V<sub>CC</sub>, L<sub>CMOS</sub> = 15 pF, Temp. Char.



20% - 80% V<sub>CC</sub>, T<sub>use</sub> = +25 °C, Output load Char.

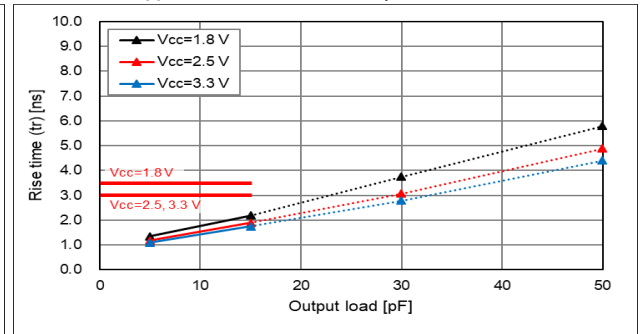

10% - 90% V<sub>CC</sub>, L<sub>CMOS</sub> = 15 pF, Temp. Char.



10% - 90% V<sub>CC</sub>, T<sub>use</sub> = +25 °C, Output load Char.

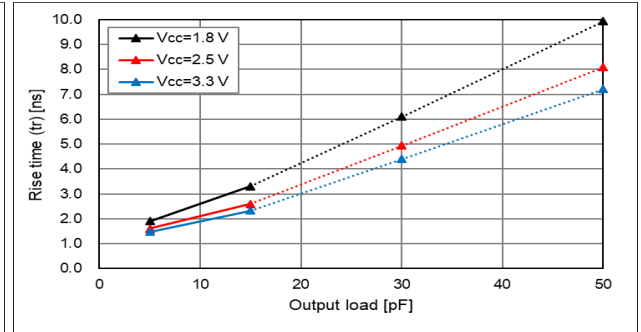

\* Output load condition under L<sub>CMOS</sub> > 15 pF (dotted line area) is not guaranteed, and the data is for reference.

fo = 40 MHz, Fall Time

20% - 80% V<sub>CC</sub>, L<sub>CMOS</sub> = 15 pF, Temp. Char.

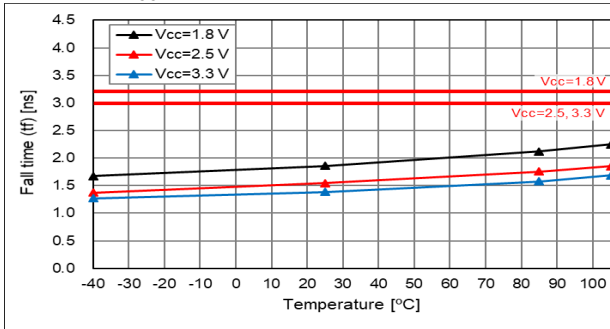

20% - 80% V<sub>CC</sub>, T<sub>use</sub> = +25 °C, Output load Char.

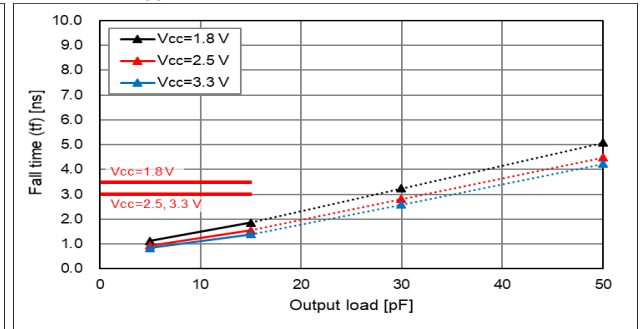

10% - 90% V<sub>CC</sub>, L<sub>CMOS</sub> = 15 pF, Temp. Char.

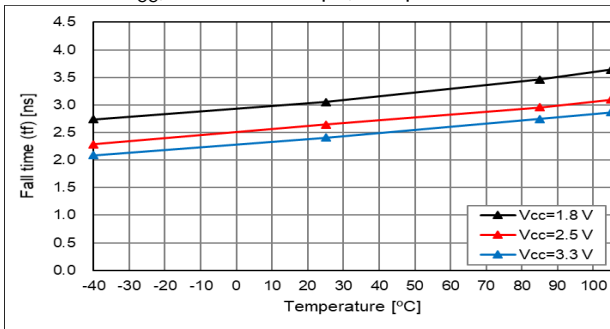

10% - 90% V<sub>CC</sub>, T<sub>use</sub> = +25 °C, Output load Char.

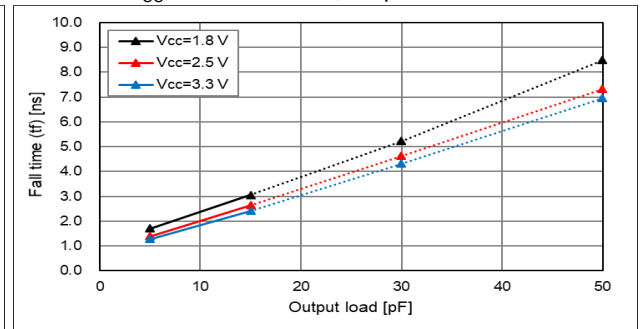

\* Output load condition under L<sub>CMOS</sub> > 15 pF (dotted line area) is not guaranteed, and the data is for reference.

(7-3) Rise Time / Fall Time [cont'd]

fo = 72 MHz, Rise Time

20% - 80% V<sub>CC</sub>, L<sub>CMOS</sub> = 15 pF, Temp. Char.

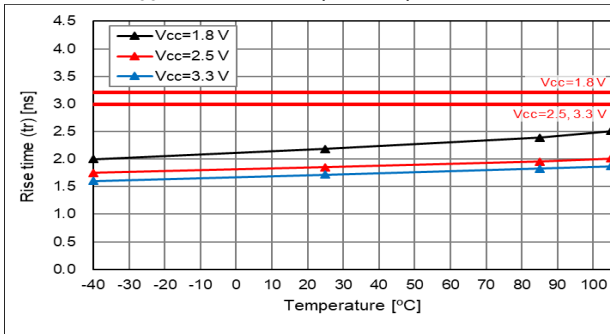

20% - 80% V<sub>CC</sub>, T<sub>use</sub> = +25 °C, Output load Char.

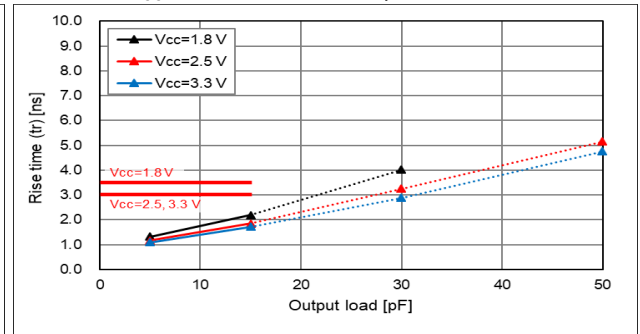

10% - 90% V<sub>CC</sub>, L<sub>CMOS</sub> = 15 pF, Temp. Char.



10% - 90% V<sub>CC</sub>, T<sub>use</sub> = +25 °C, Output load Char.



\* Output load condition under L<sub>CMOS</sub> > 15 pF (dotted line area) is not guaranteed, and the data is for reference.

There are some missing data in the graph. It is unmeasurable because of low amplitude under the condition of L<sub>CMOS</sub> > 15 pF.

fo = 72 MHz, Fall Time

20% - 80% V<sub>CC</sub>, L<sub>CMOS</sub> = 15 pF, Temp. Char.

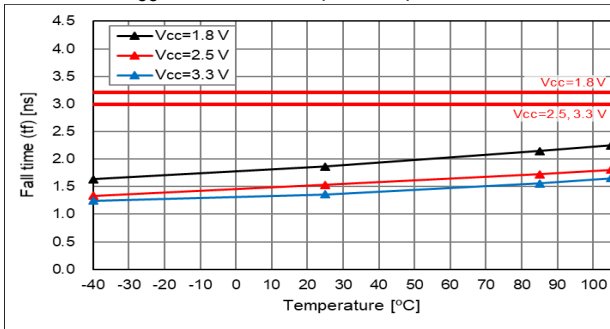

20% - 80% V<sub>CC</sub>, T<sub>use</sub> = +25 °C, Output load Char.

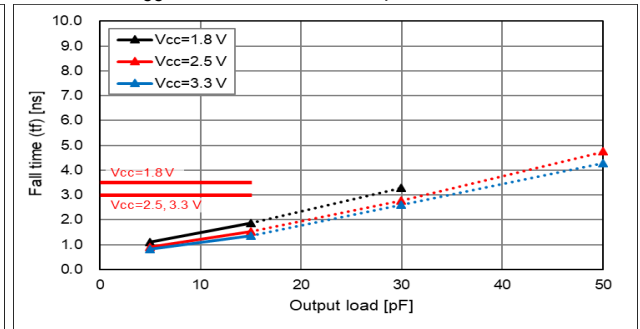

10% - 90% V<sub>CC</sub>, L<sub>CMOS</sub> = 15 pF, Temp. Char.

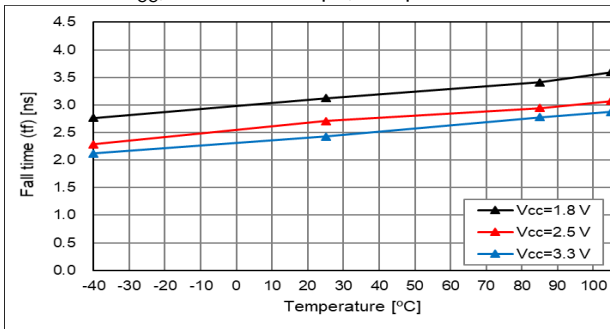

10% - 90% V<sub>CC</sub>, T<sub>use</sub> = +25 °C, Output load Char.

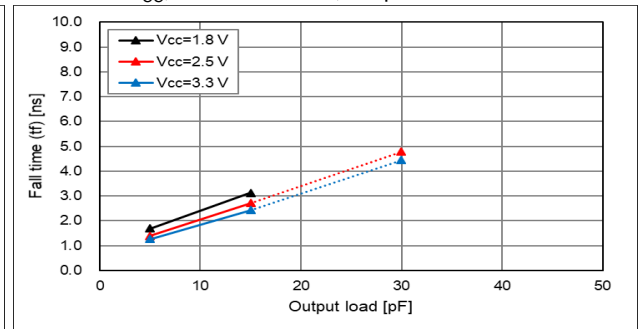

\* Output load condition under L<sub>CMOS</sub> > 15 pF (dotted line area) is not guaranteed, and the data is for reference.

There are some missing data in the graph. It is unmeasurable because of low amplitude under the condition of L<sub>CMOS</sub> > 15 pF.

## (7-4) Symmetry

fo = 20 MHz

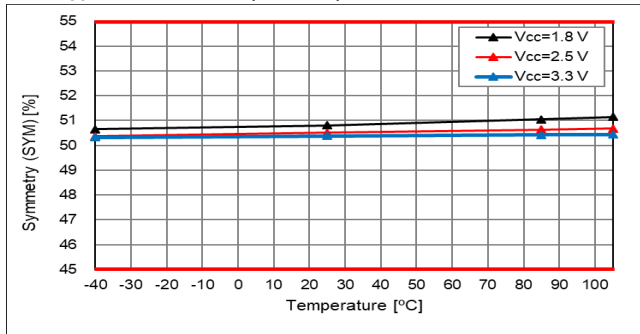
50 %V<sub>CC</sub>, L\_CMOS = 15 pF, Temp. Char.

fo = 40 MHz

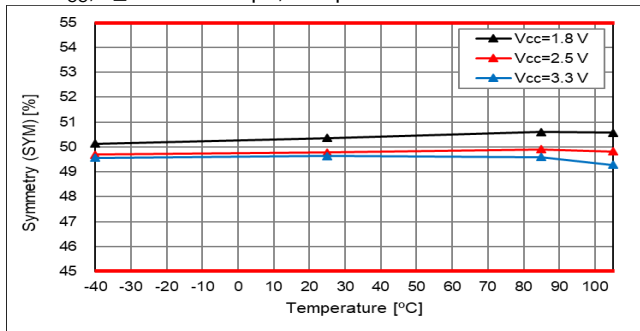
50 %V<sub>CC</sub>, L\_CMOS = 15 pF, Temp. Char.

fo = 72 MHz

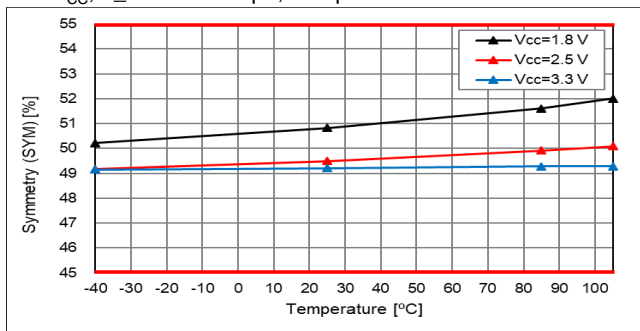
50 %V<sub>CC</sub>, L\_CMOS = 15 pF, Temp. Char.

## (7-5) Output Voltage

fo = 20 MHz

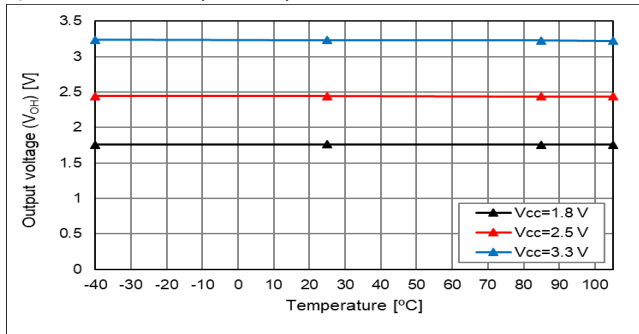
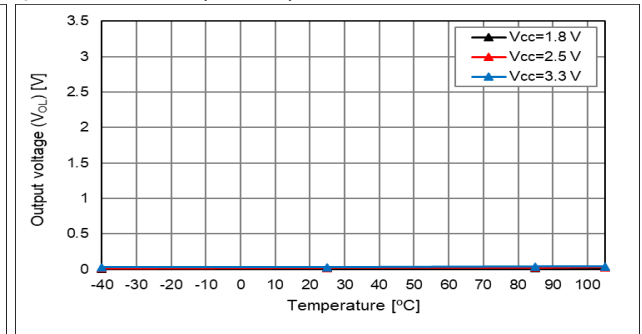
V<sub>OH</sub>, L\_CMOS = 15 pF, Temp. Char.V<sub>OL</sub>, L\_CMOS = 15 pF, Temp. Char.

fo = 40 MHz

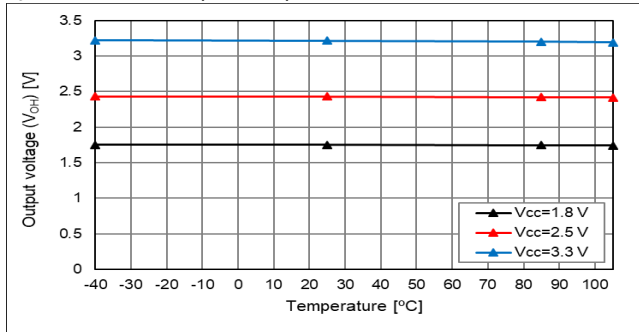
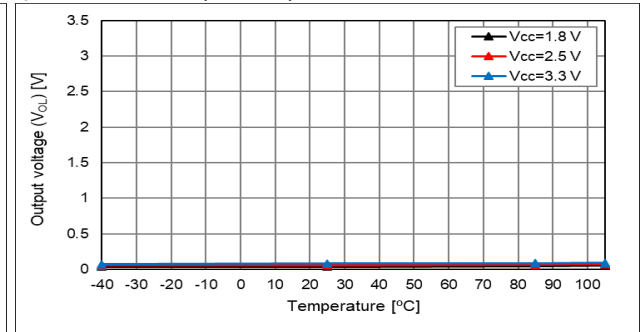
V<sub>OH</sub>, L\_CMOS = 15 pF, Temp. Char.V<sub>OL</sub>, L\_CMOS = 15 pF, Temp. Char.

fo = 72 MHz

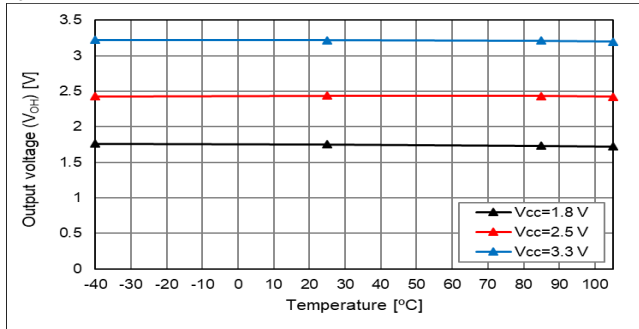
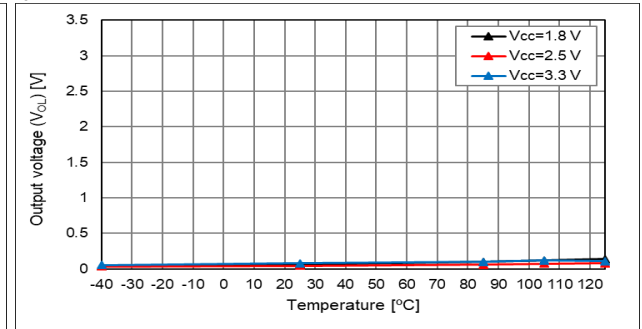
V<sub>OH</sub>, L\_CMOS = 15 pF, Temp. Char.V<sub>OL</sub>, L\_CMOS = 15 pF, Temp. Char.



(7-6) Phase Noise, Phase Jitter, and Jitter

fo = 20 MHz

V<sub>CC</sub> = 3.3 V, T<sub>use</sub> = +25 °C

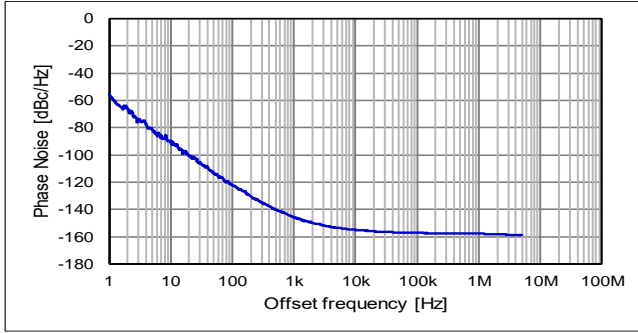

V<sub>CC</sub> = 2.5 V, T<sub>use</sub> = +25 °C

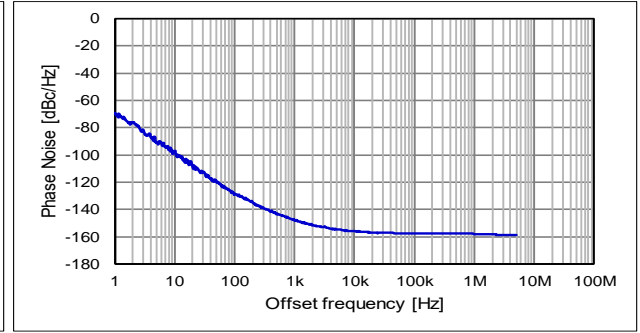

V<sub>CC</sub> = 1.8 V, T<sub>use</sub> = +25 °C

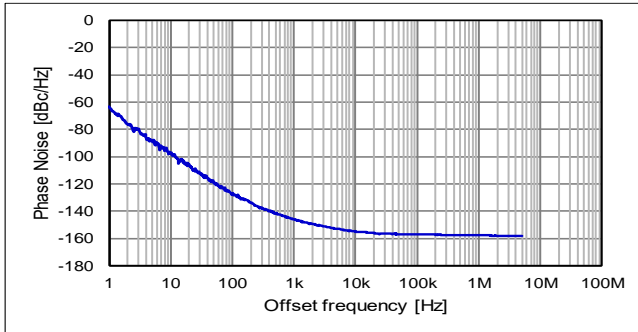

Phase Jitter (Offset frequency: 12 kHz to 5 MHz)

V <sub>CC</sub>	Phase Jitter
3.3 V	0.31 ps
2.5 V	0.31 ps
1.8 V	0.32 ps

Jitter (T<sub>use</sub> = +25 °C, V<sub>CC</sub> = 3.3 V)

Total jitter (BER = 10 <sup>-12</sup> )	31.3 ps
RMS jitter	1.8 ps
Peak to peak jitter	15 ps

fo = 40 MHz

V<sub>CC</sub> = 3.3 V, T<sub>use</sub> = +25 °C

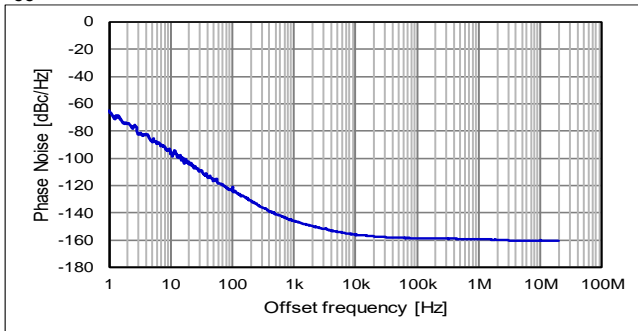

V<sub>CC</sub> = 2.5 V, T<sub>use</sub> = +25 °C

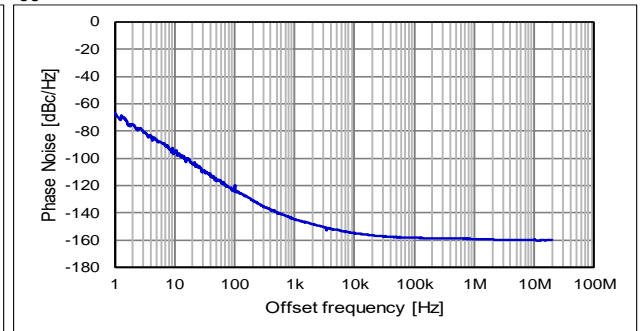

V<sub>CC</sub> = 1.8 V, T<sub>use</sub> = +25 °C

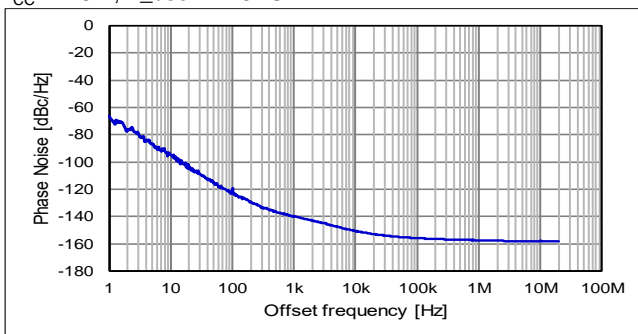

Phase Jitter (Offset frequency: 12 kHz to 20 MHz)

V <sub>CC</sub>	Phase Jitter
3.3 V	0.24 ps
2.5 V	0.26 ps
1.8 V	0.32 ps

Jitter (T<sub>use</sub> = +25 °C, V<sub>CC</sub> = 3.3 V)

Total jitter (BER = 10 <sup>-12</sup> )	22.3 ps
RMS jitter	1.8 ps
Peak to peak jitter	16 ps

(7-6) Phase Noise and Phase Jitter [cont'd]

fo = 72 MHz

V<sub>CC</sub> = 3.3 V, T<sub>use</sub> = +25 °C



V<sub>CC</sub> = 2.5 V, T<sub>use</sub> = +25 °C



V<sub>CC</sub> = 1.8 V, T<sub>use</sub> = +25 °C



Phase Jitter (Offset frequency: 12 kHz to 20 MHz)

V <sub>CC</sub>	Phase Jitter
3.3 V	0.16 ps
2.5 V	0.17 ps
1.8 V	0.20 ps

Jitter (T<sub>use</sub> = +25 °C, V<sub>CC</sub> = 3.3 V)

Total jitter (BER = 10 <sup>-12</sup> )	21.8 ps
RMS jitter	1.8 ps
Peak to peak jitter	16 ps

(7-7) Output Waveform

fo = 20 MHz

V<sub>CC</sub> = 3.3 V, L<sub>CMOS</sub> = 15 pF, T<sub>use</sub> = +25 °C

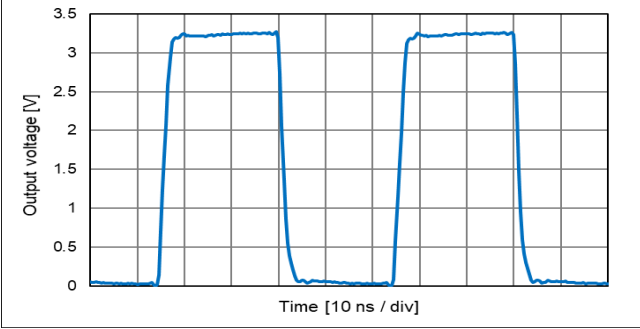

V<sub>CC</sub> = 2.5 V, L<sub>CMOS</sub> = 15 pF, T<sub>use</sub> = +25 °C

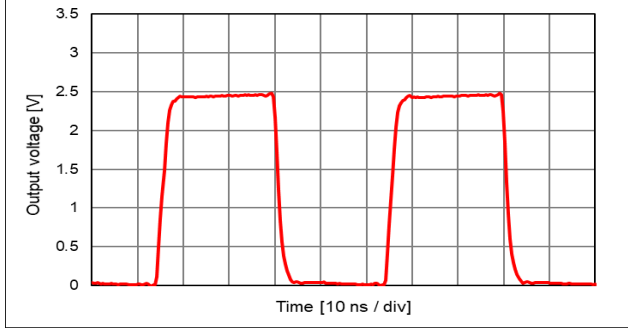

V<sub>CC</sub> = 1.8 V, L<sub>CMOS</sub> = 15 pF, T<sub>use</sub> = +25 °C

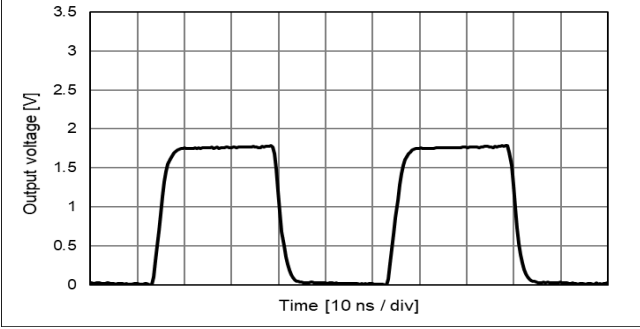

fo = 40 MHz

V<sub>CC</sub> = 3.3 V, L<sub>CMOS</sub> = 15 pF, T<sub>use</sub> = +25 °C

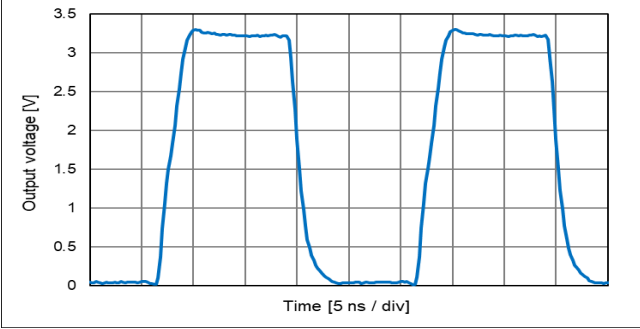

V<sub>CC</sub> = 2.5 V, L<sub>CMOS</sub> = 15 pF, T<sub>use</sub> = +25 °C

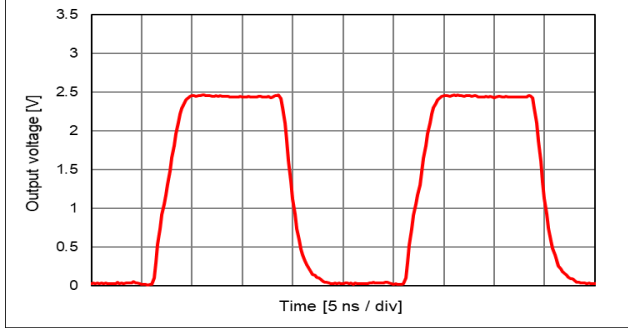

V<sub>CC</sub> = 1.8 V, L<sub>CMOS</sub> = 15 pF, T<sub>use</sub> = +25 °C

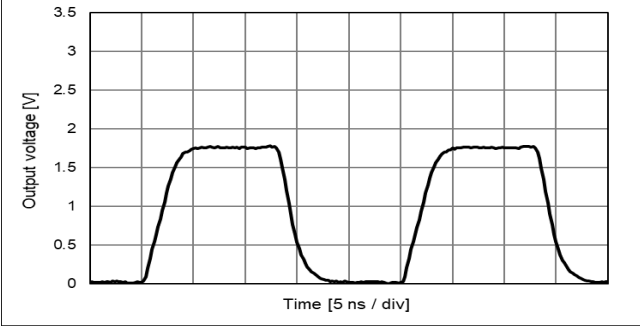

(7-7) Output Waveform [cont'd]

fo = 72 MHz

V<sub>CC</sub> = 3.3 V, L<sub>CMOS</sub> = 15 pF, T<sub>use</sub> = +25 °C

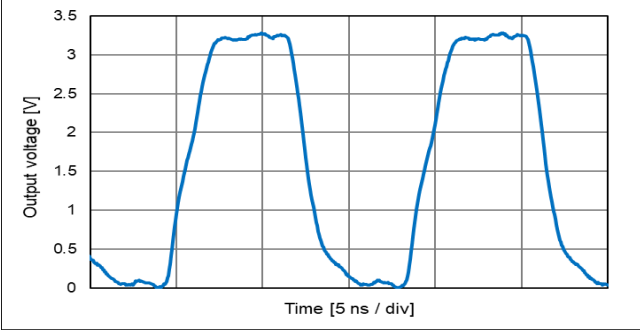

V<sub>CC</sub> = 2.5 V, L<sub>CMOS</sub> = 15 pF, T<sub>use</sub> = +25 °C

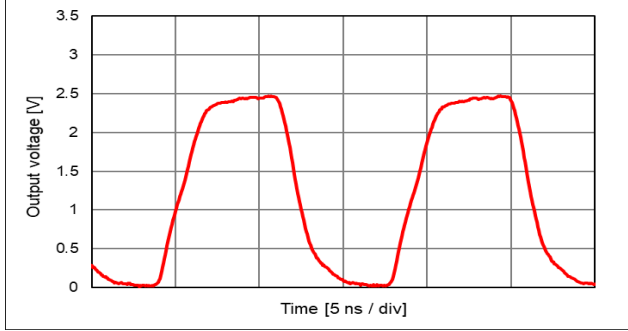

V<sub>CC</sub> = 1.8 V, L<sub>CMOS</sub> = 15 pF, T<sub>use</sub> = +25 °C

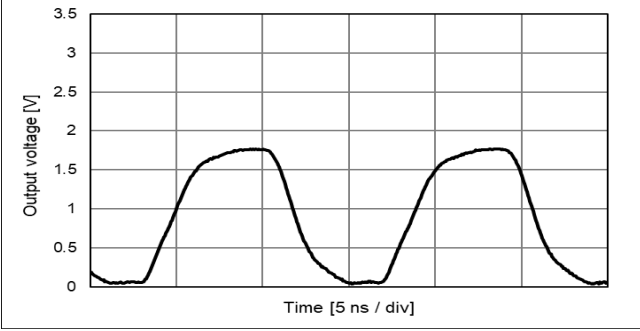

## [ 8 ] Test Circuit

## (8-1) Waveform Observation

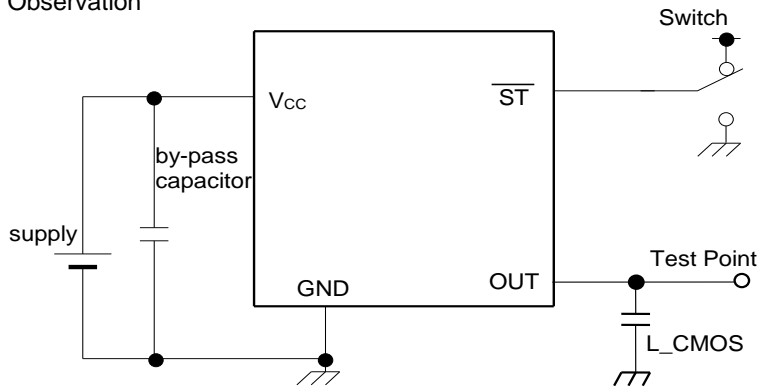

## (8-2) Current Consumption Test

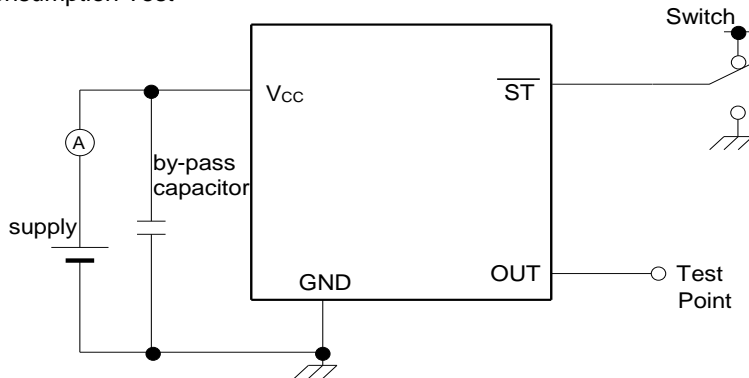

\*Standby current test should be  $\overline{ST} = \text{GND}$ .

## (8-3) Condition

## (1) Oscilloscope

The bandwidth should be minimum 5 times wider than measurement frequency

The probe ground should be placed closely to the test point and the lead length should be as short as possible

\* It is recommended to use miniature socket. (Don't use earth lead.)

(2)  $L_{\text{CMOS}}$  includes probe capacitance.(3) A 0.01  $\mu\text{F}$  to a 0.1  $\mu\text{F}$  bypass capacitor should be connected between  $V_{\text{CC}}$  and GND pins located close to the device

## (4) Use a current meter with a low internal impedance

## (5) Power Supply

Power supply startup time ( $0\%V_{\text{CC}} \rightarrow 90\%V_{\text{CC}}$ ) should be more than 150  $\mu\text{s}$

Power supply impedance should be as low as possible

(8-4) Timing Chart

(1) Output Waveform and Level



(2) Output Frequency Timing



(3)  $\overline{ST}$  Function and Timing

$\overline{ST}$ Terminal	Osc. circuit	Output status
"H" or OPEN	Oscillation	Specified frequency: Enable
"L"	Oscillation stop	High impedance: Disable

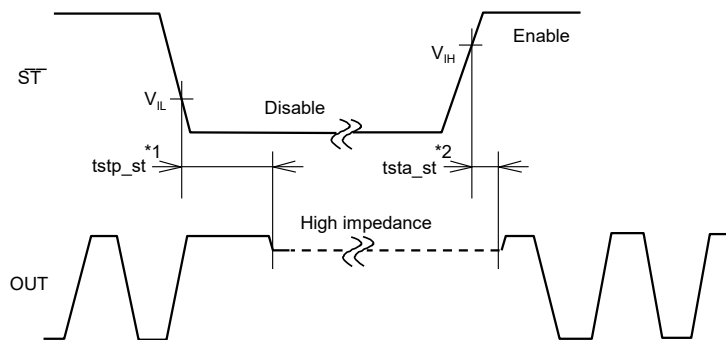

\*1 The period from  $\overline{ST} = V_{IL}$  to  $OUT = High\ impedance\ (Disable)$

\*2 The period from  $\overline{ST} = V_{IH}$  to  $OUT = Enable$

\* Judge of starting output:  $V_{OH} \geq 80\%V_{CC}$ ,  $V_{OL} \leq 20\%V_{CC}$ ,  $f_{out}$  is within  $f_o \pm 1\ 000 \times 10^{-6}$

\*  $\overline{ST}$  terminal voltage level should not exceed supply voltage when using  $\overline{ST}$  function.

Please note that  $\overline{ST}$  rise time should not exceed supply voltage rise time at the start-up.

[ 9 ] Outline Drawing and Recommended Footprint  
(9-1) SG2016CAN

Units: mm

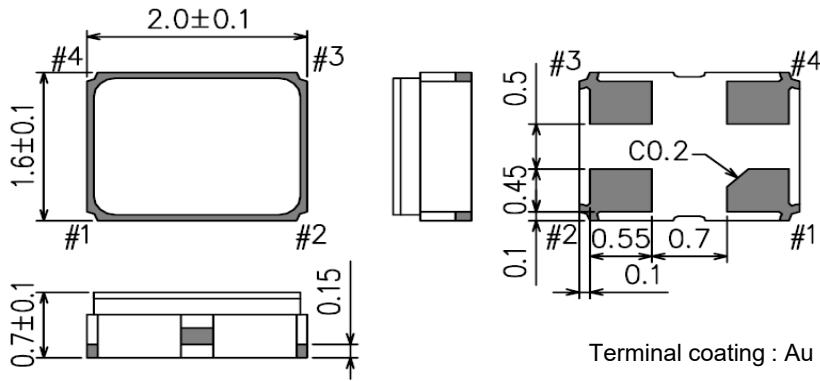

Terminal coating : Au plating

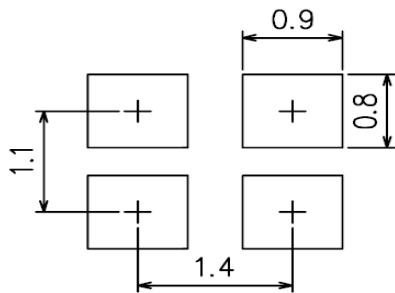

For stable operation, it is recommended that 0.01 μF to 0.1 μF bypass capacitors should be connected between V<sub>CC</sub> and GND and placed as close to the V<sub>CC</sub> pin as possible.

Reference Weight Typ.: 9.9 mg

Terminal Assignment

Pin #	Connection	Function		
#1	ST	ST terminal		
		ST function	Osc. Circuit	Output
		"H" or OPEN	Oscillation	Specified frequency: Enable
		"L"	Oscillation stop	High impedance: Disable
#2	GND	GND terminal		
#3	OUT	Output terminal		
#4	V <sub>CC</sub>	V <sub>CC</sub> terminal		

Marking

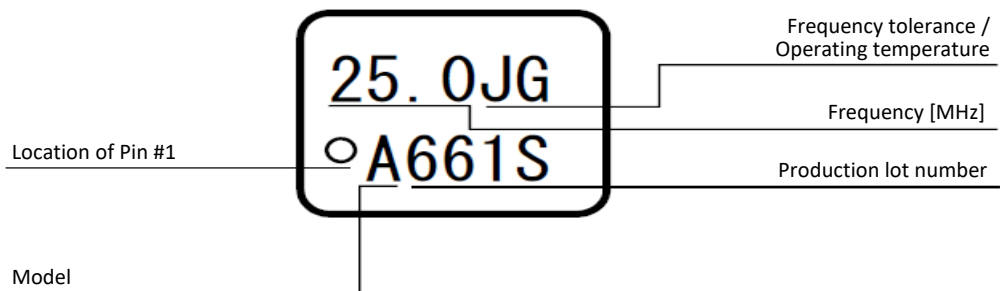

(9-2) SG-210STF

Units: mm

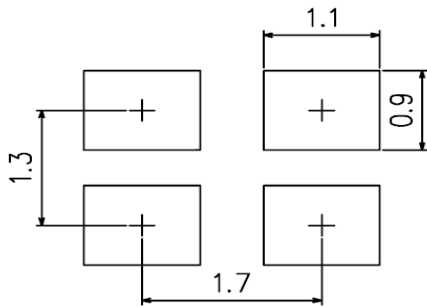
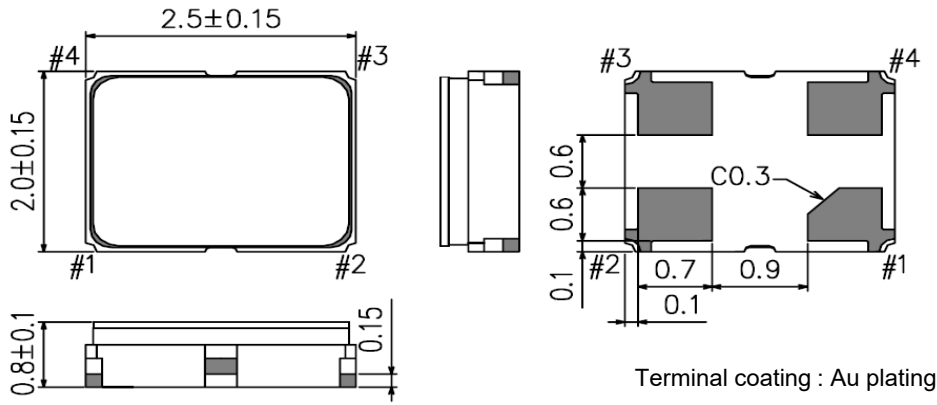

For stable operation, it is recommended that 0.01  $\mu$ F to 0.1  $\mu$ F bypass capacitors should be connected between  $V_{CC}$  and GND and placed as close to the  $V_{CC}$  pin as possible.

Reference Weight Typ.: 14 mg

Terminal Assignment

Pin #	Connection	Function		
#1	ST	ST terminal		
		ST function	Osc. Circuit	Output
		"H" or OPEN	Oscillation	Specified frequency: Enable
		"L"	Oscillation stop	High impedance: Disable
#2	GND	GND terminal		
#3	OUT	Output terminal		
#4	$V_{CC}$	$V_{CC}$ terminal		

Marking

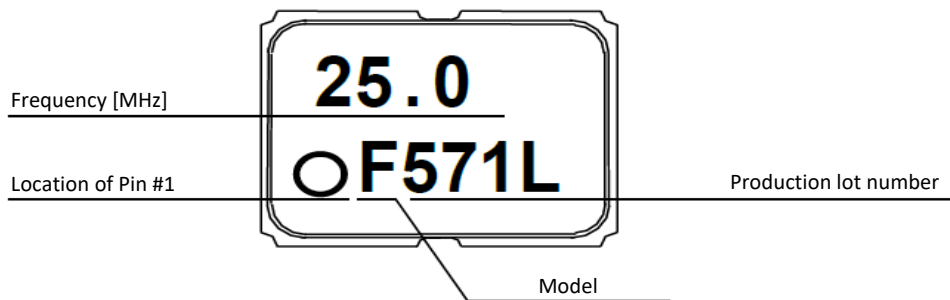



(9-3) SG3225CAN

Units: mm

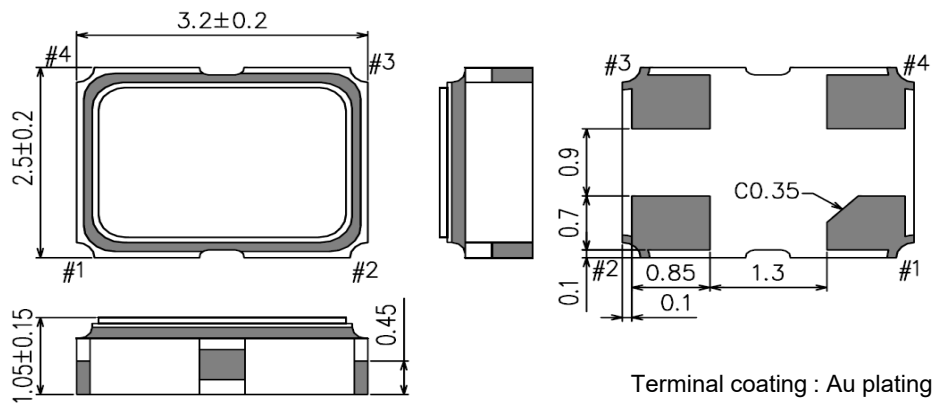

Terminal coating : Au plating

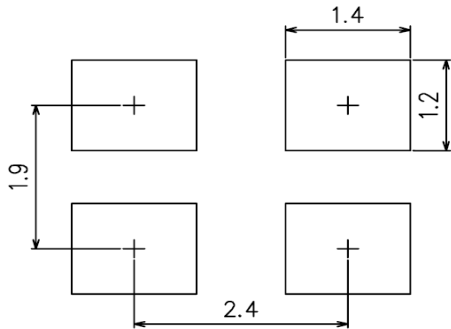

For stable operation, it is recommended that 0.01  $\mu$ F to 0.1  $\mu$ F bypass capacitors should be connected between  $V_{CC}$  and GND and placed as close to the  $V_{CC}$  pin as possible.

Reference Weight Typ.: 25 mg

Terminal Assignment

Pin #	Connection	Function		
#1	ST	ST terminal		
		ST function	Osc. Circuit	Output
		"H" or OPEN	Oscillation	Specified frequency: Enable
		"L"	Oscillation stop	High impedance: Disable
#2	GND	GND terminal		
#3	OUT	Output terminal		
#4	$V_{CC}$	$V_{CC}$ terminal		

Marking

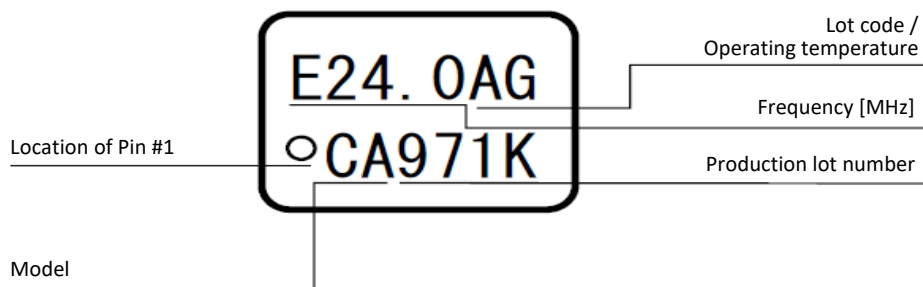

(9-4) SG5032CAN

Units: mm

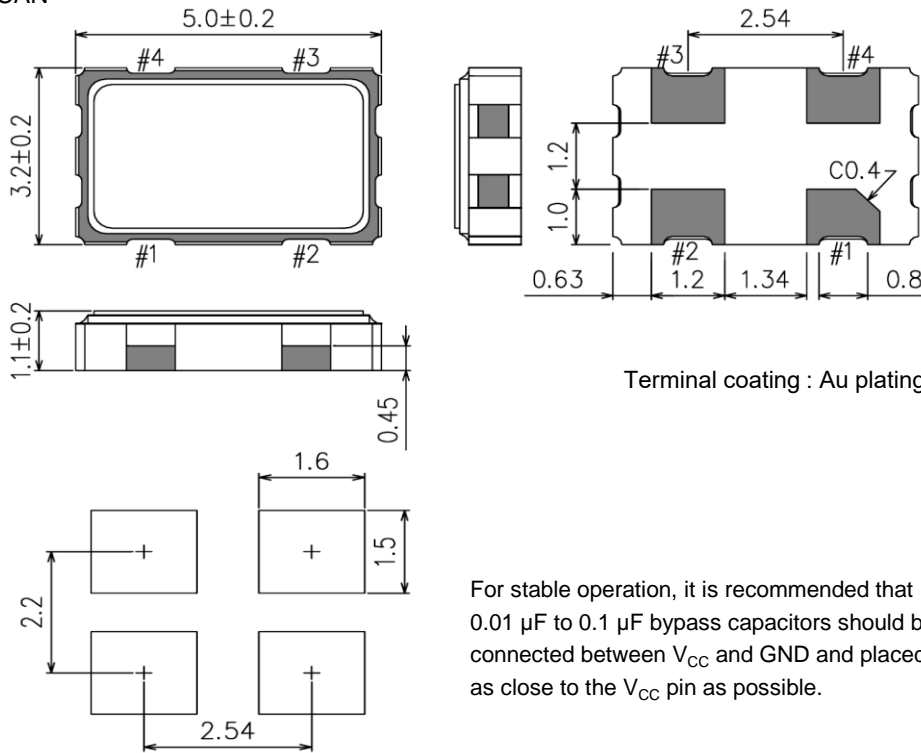

Reference Weight Typ.: 52 mg

Terminal Assignment

Pin #	Connection	Function		
#1	ST	ST terminal		
		ST function	Osc. Circuit	Output
		"H" or OPEN	Oscillation	Specified frequency: Enable
		"L"	Oscillation stop	High impedance: Disable
#2	GND	GND terminal		
#3	OUT	Output terminal		
#4	V <sub>CC</sub>	V <sub>CC</sub> terminal		

Marking

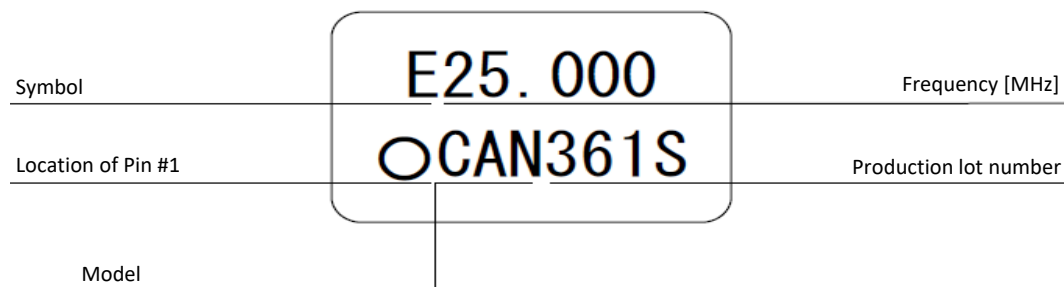

(9-5) SG7050CAN

Units: mm

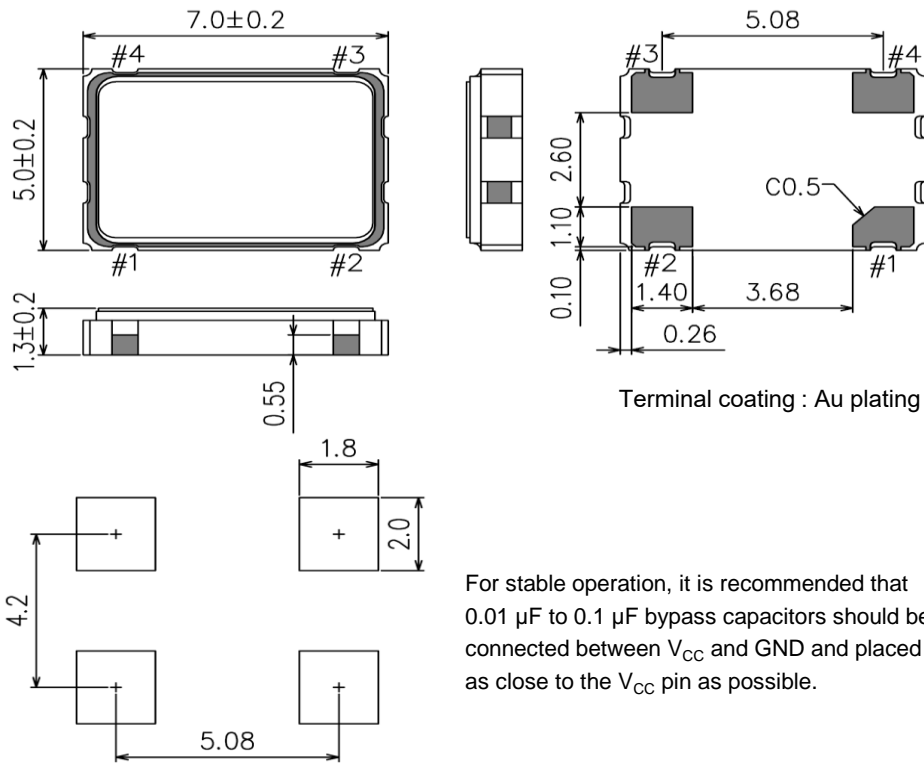

For stable operation, it is recommended that 0.01  $\mu$ F to 0.1  $\mu$ F bypass capacitors should be connected between  $V_{CC}$  and GND and placed as close to the  $V_{CC}$  pin as possible.

Reference Weight Typ.: 147 mg

Terminal Assignment

Pin #	Connection	Function		
#1	ST	ST terminal		
		ST function	Osc. Circuit	Output
		"H" or OPEN	Oscillation	Specified frequency: Enable
		"L"	Oscillation stop	High impedance: Disable
#2	GND	GND terminal		
#3	OUT	Output terminal		
#4	$V_{CC}$	$V_{CC}$ terminal		

Marking

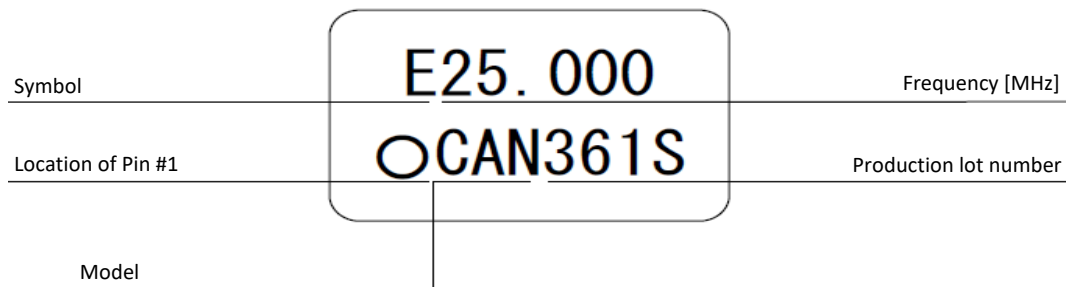

[ 10 ] Moisture Sensitivity Level

Parameter	Specification	Conditions
MSL	LEVEL 1	IPC/JEDEC J-STD-020D.1

[ 11 ] Reflow Profiles  
 IPC/JEDEC J-STD-020D.1

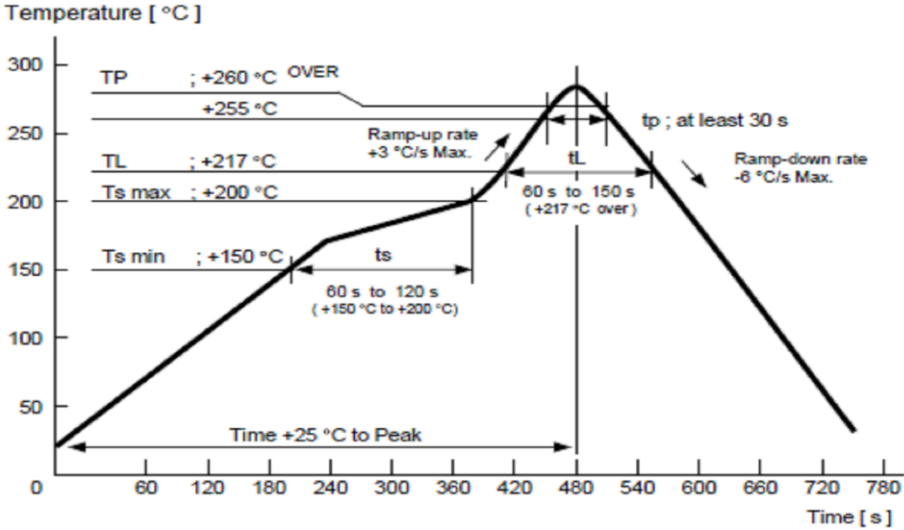

## [ 12 ] Packing Information

## (12-1) SG2016CAN

## (1) Packing Quantity

The last two digits of the Product Number (X1G004801xxxxxx) are a code that defines the packing quantity. The standard is "00" for a 3 000 pcs/Reel.

## (2) Taping Specification

Subject to EIA-481, IEC-60286 and JIS C0806

## 1) Tape Dimensions

Carrier Tape Material: PS (Polystyrene)

Top Tape Material: PET (Polyethylene Terephthalate) +PE (Polyethylene)

Units: mm

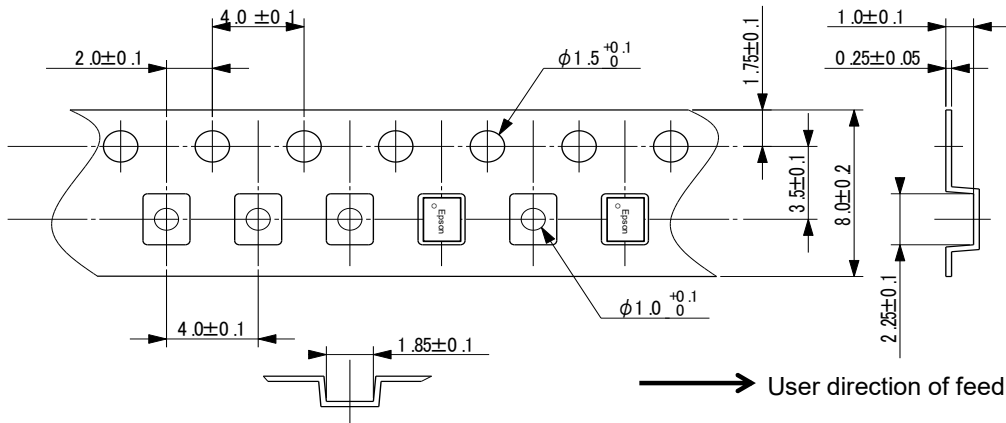

## 2) Reel Dimensions

Center Material: PS (Polystyrene)

Reel Material: PS (Polystyrene)

Units: mm

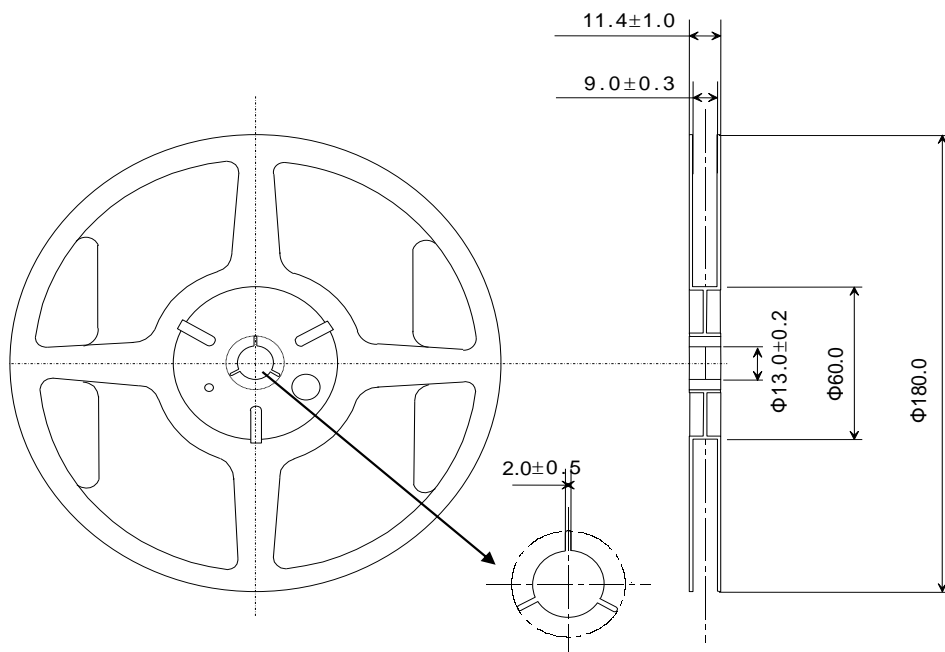

## 3) Storage Environment

We recommend to keep less than +30 °C and 85 %RH of humidity in a packed condition, and to use it less than 6 months after delivery.

(12-2) SG-210STF

(1) Packing Quantity

The last two digits of the Product Number (X1G004171xxxxxx) are a code that defines the packing quantity. The standard is "00" for a 3 000 pcs/Reel.

(2) Taping Specification

Subject to EIA-481, IEC-60286 and JIS C0806

1) Tape Dimensions

Carrier Tape Material: PS (Polystyrene)

Top Tape Material: PET (Polyethylene Terephthalate) +PE (Polyethylene)

Units: mm

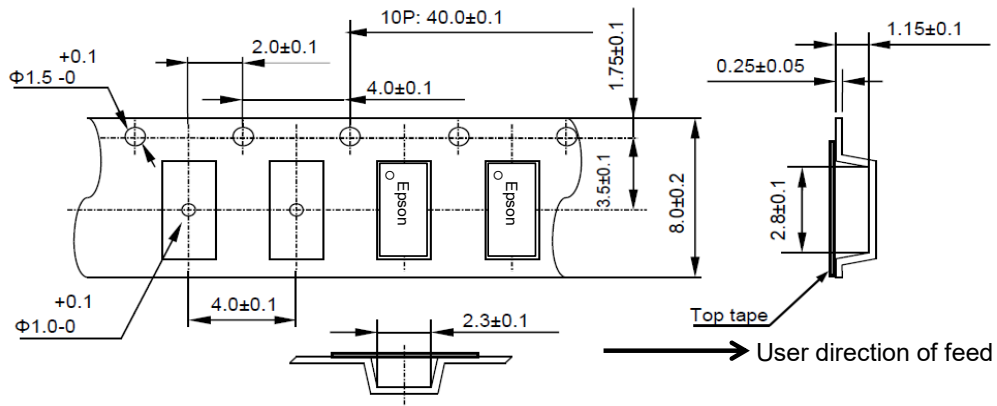

2) Reel Dimensions

Center Material: PS (Polystyrene)

Reel Material: PS (Polystyrene)

Units: mm

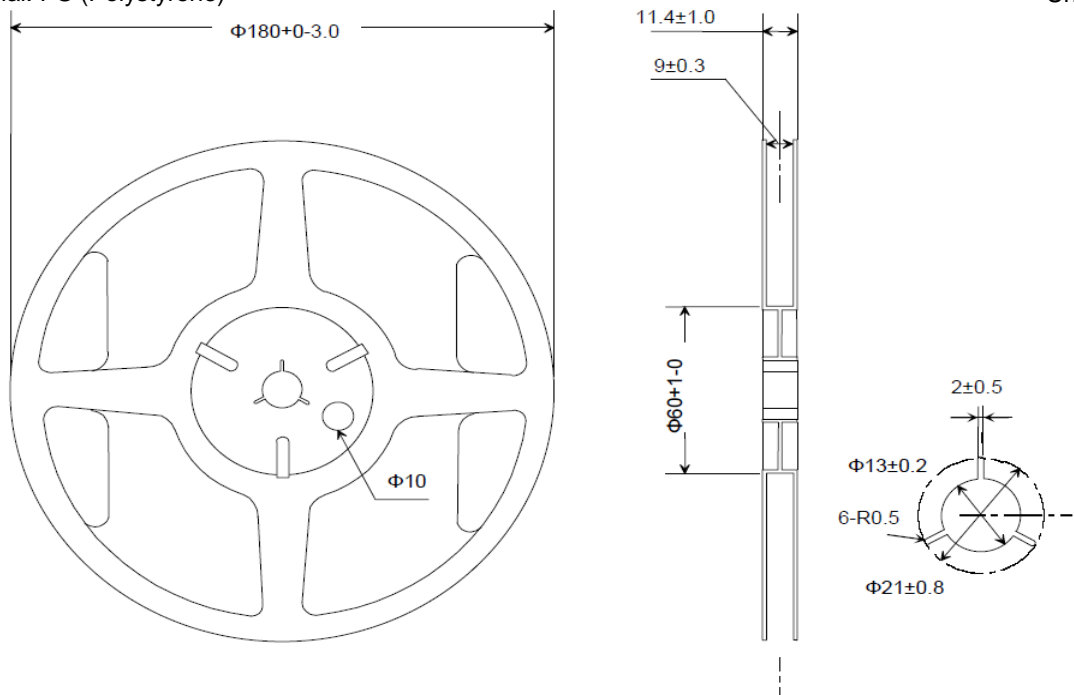

3) Storage Environment

We recommend to keep less than +30 °C and 85 %RH of humidity in a packed condition, and to use it less than 6 months after delivery.



(12-4) SG5032CAN

(1) Packing Quantity

The last two digits of the Product Number (X1G004451xxxxxx) are a code that defines the packing quantity. The standard is "00" for a 1 000 pcs/Reel.

(2) Taping Specification

Subject to EIA-481, IEC-60286 and JIS C0806

1) Tape Dimensions

Carrier Tape Material: PS (Polystyrene)

Top Tape Material: PET (Polyethylene Terephthalate) +PE (Polyethylene)

Units: mm

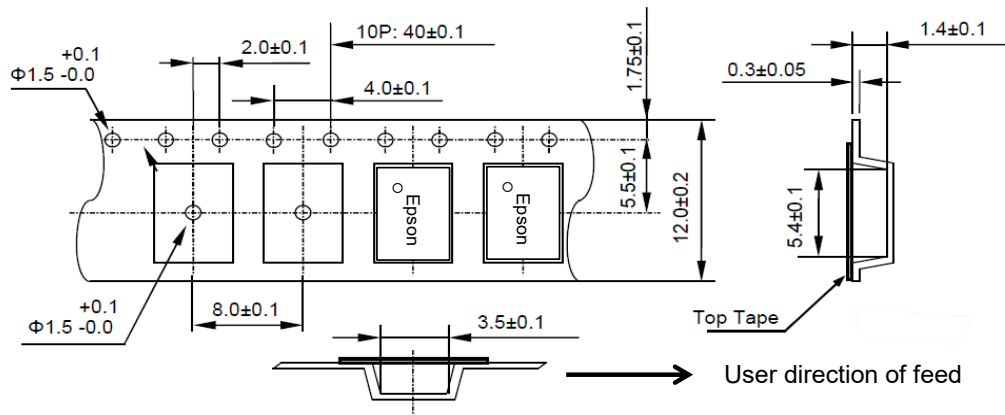

2) Reel Dimensions

Center Material: PS (Polystyrene)

Reel Material: PS (Polystyrene)

Units: mm

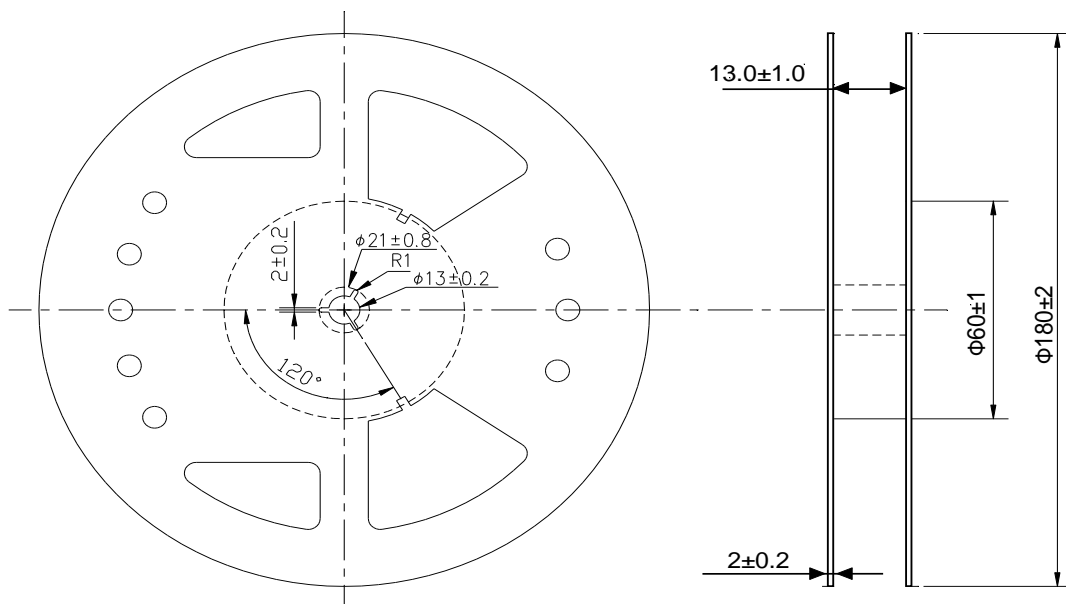

3) Storage Environment

We recommend to keep less than +30 °C and 85 %RH of humidity in a packed condition, and to use it less than 6 months after delivery.





## [ 13 ] Handling Precautions

Prior to using this product, please carefully read the section entitled "Precautions" on our Web site (<https://www5.epsondevice.com/en/information/#precaution>) for instructions on how to handle and use the product properly to ensure optimal performance of the product in your equipment.

Before using the product under any conditions other than those specified therein, please consult with us to verify and confirm that the performance of the product will not be negatively affected by use under such conditions.

In addition to the foregoing precautions, in order to avoid the deteriorating performance of the product, we strongly recommend that you DO NOT use the product under ANY of the following conditions:

- (1) Do not expose this product to excessive mechanical shock or vibration.
- (2) This product can be damaged by mechanical shock during the soldering process depending on the equipment used, process conditions, and any impact forces experienced. Always follow appropriate procedures, particularly when changing the assembly process in any way and be sure to follow applicable process qualification standards before starting production.
- (3) These devices are sensitive to ESD, use appropriate precautions during handling, assembly, test, shipment, and installation.
- (4) The use of ultrasonic technology for cleaning, bonding, etc. can damage the Xtal unit inside this product. Please carefully check for this consideration before using ultrasonic equipment for volume production with this product.
- (5) Noise and ripple on the power supply may have undesirable effects on operation and cause degradation of phase noise characteristics. Evaluate the operation of this device with appropriate power supplies carefully before use.
- (6) When applying power, ensure that the supply voltage increases monotonically for proper operation. On power down, do not reapply power until the supplies, bypass capacitors, and any bulk capacitors are completely discharged since that may cause the unit to malfunction.
- (7) Aging specifications are estimated from environmental reliability tests and expected frequency variation over time. They do not provide a guarantee of aging over the product lifecycle.
- (8) The metal cap on top of the device is directly connected to the GND terminal. Take necessary precautions to prevent any conductor not at ground potential from contacting the cap as that could cause a short circuit to GND.
- (9) Do not route any signal lines, supply voltage lines, or GND lines underneath the area where the oscillators are mounted including any internal layers and on the opposite side of the PCB. To avoid any issues due to interference of other signal lines, please take care not to place signal lines near the product as this may have an adverse effect on the performance of the product.
- (10) A bypass capacitor of the recommended value(s) must be connected between the  $V_{CC}$  and GND terminals of the product. Whenever possible, mount the capacitor(s) on the same side of the PCB and as close to the product as possible to keep the routing traces short.
- (11) Power supply connections to  $V_{CC}$  and GND pins should be routed as thick as possible while keeping the high frequency impedance low in order to get the best performance.
- (12) The use of a filter or similar element in series with the power supply connections to protect from electromagnetic radiation noise may increase the high frequency impedance of the power supply line and may cause the oscillator to not operate properly. Please verify the design to ensure sufficient operational margin prior to use.
- (13) Keep PCB routing from the output terminal(s) to the load as short as possible for best performance.
- (14) The Enable (ST) input terminal is high impedance and so susceptible to noise. Connect it to a low impedance source when used and when not used it is recommended to connect it to  $V_{CC}$  for active high inputs and GND for active low inputs.
- (15) Do not short the output to GND as that will damage the product. Always use with an appropriate load resistor connected.
- (16) This product should be reflowed no more than 3 times.
 

[Availability of mounting conditions]	
Reflow on the board	Available The parts may fall. Please judge whether it is possible to implement.
Reflow under the board	
Soldering pot/bath (Dip soldering system, Flow soldering system)	<b>Not Available</b>
Soldering iron	Available

If rework is needed after reflow, please correct it with a soldering iron with the tip set for a temperature of +350 °C or less and only contact each terminal once and for no more than 5 seconds. If this product is mounted on the bottom of the board during a reflow please check that it soldered down properly afterwards.
- (17) Product failures during the warranty period only apply when the product is used according to the recommended operating conditions described in the specifications. Products that have been opened for analysis or damaged will not be covered. It is recommended to store and use in normal temperature and humidity environments described in the specifications to ensure frequency accuracy and prevent moisture condensation. If the product is stored for more than one year, please confirm the pin solderability prior to use.
- (18) If the oscillation circuit is exposed to condensation, the frequency may change or oscillation may stop. Do not use in any conditions where condensation occurs.
- (19) Do not store or use the product in an environment where it can be exposed to chemical substances that are corrosive to metal or plastics such as salt water, organic solvents, chemical gasses, etc. Do not use the product when it is exposed to sunlight, dust, corrosive gasses, or other materials for long periods of time.
- (20) When using water-soluble solder flux make sure to completely remove the flux residue after soldering. Pay particular attention when the residues contain active halogens which will negatively affect the product and its performance.
- (21) Terminals on the side of the product are internally connected to the IC, be careful not to cause short-circuits or reduce the insulation resistance of them in any way.
- (22) Should any customer use the product in any manner contrary to the precautions and/or advice herein, such use shall be done at the customer's own risk.

## PROMOTION OF ENVIRONMENTAL MANAGEMENT SYSTEM CONFORMING TO INTERNATIONAL STANDARDS

At Seiko Epson, all environmental initiatives operate under the Plan-Do-Check-Action (PDCA) cycle designed to achieve continuous improvements. The environmental management system (EMS) operates under the ISO 14001 environmental management standard.

All of our major manufacturing and non-manufacturing sites, in Japan and overseas, completed the acquisition of ISO 14001 certification.



ISO 14000 is an international standard for environmental management that was established by the International Standards Organization in 1996 against the background of growing concern regarding global warming, destruction of the ozone layer, and global deforestation.

## WORKING FOR HIGH QUALITY

In order provide high quality and reliable products and services than meet customer needs, Seiko Epson made early efforts towards obtaining ISO9000 series certification and has acquired ISO9001 for all business establishments in Japan and abroad. We have also acquired IATF 16949 certification that is requested strongly by major manufacturers as standard.

IATF 16949 is the international standard that added the sector-specific supplemental requirements for automotive industry based on ISO9001.

### ■ Explanation of marks used in this datasheet

	<p>●Pb free.</p>
	<p>●Complies with EU RoHS directive. *About the products without the Pb-free mark. Contains Pb in products exempted by EU RoHS directive (Contains Pb in sealing glass, high melting temperature type solder or other)</p>

NOTICE: PLEASE READ CAREFULLY BELOW BEFORE THE USE OF THIS DOCUMENT ©Seiko Epson Corporation 2020

- The content of this document is subject to change without notice. Before purchasing or using Epson products, please contact with sales representative of Seiko Epson Corporation ("Epson") for the latest information and be always sure to check the latest information published on Epson's official web sites and resources.
- This document may not be copied, reproduced, or used for any other purposes, in whole or in part, without Epson's prior consent.
- Information provided in this document including, but not limited to application circuits, programs and usage, is for reference purpose only. Epson makes no guarantees against any infringements or damages to any third parties' intellectual property rights or any other rights resulting from the information. This document does not grant you any licenses, any intellectual property rights or any other rights with respect to Epson products owned by Epson or any third parties.
- Using Epson products, you shall be responsible for safe design in your products; that is, your hardware, software, and/or systems shall be designed enough to prevent any critical harm or damages to life, health or property, even if any malfunction or failure might be caused by Epson products. In designing your products with Epson products, please be sure to check and comply with the latest information regarding Epson products (including, but not limited to this document, specifications, data sheets, manuals, and Epson's web site). Using technical contents such as product data, graphic and chart, and technical information, including programs, algorithms and application circuit examples under this document, you shall evaluate your products thoroughly both in stand-alone basis and within your overall systems. You shall be solely responsible for deciding whether to adopt/use Epson products with your products.
- Epson has prepared this document carefully to be accurate and dependable, but Epson does not guarantee that the information is always accurate and complete. Epson assumes no responsibility for any damages you incurred due to any misinformation in this document.
- No dismantling, analysis, reverse engineering, modification, alteration, adaptation, reproduction, etc., of Epson products is allowed.
- Epson products have been designed, developed and manufactured to be used in general electronic applications and specifically requires particular quality or extremely high reliability in order to refrain from causing any malfunction or failure leading to critical harm to life and health, serious property damage, or severe impact on society, including, but not limited to listed below ("Specific Purpose"). Therefore, you are strongly advised to use Epson products only for the Anticipated Purpose. Should you desire to purchase and use Epson products for Specific Purpose, Epson makes no warranty and disclaims with respect to Epson products, whether express or implied, including without limitation any implied warranty of merchantability or fitness for any Specific Purpose. Please be sure to contact our sales representative in advance, if you desire Epson products for Specific Purpose:  
Space equipment (artificial satellites, rockets, etc.)/ Transportation vehicles and their control equipment (automobiles, aircraft, trains, ships, etc.) / Medical equipment/ Relay equipment to be placed on sea floor/ Power station control equipment / Disaster or crime prevention equipment/Traffic control equipment/ Financial equipment  
Other applications requiring similar levels of reliability as the above
- Epson products listed in this document and our associated technologies shall not be used in any equipment or systems that laws and regulations in Japan or any other countries prohibit to manufacture, use or sell. Furthermore, Epson products and our associated technologies shall not be used for the purposes of military weapons development (e.g. mass destruction weapons), military use, or any other military applications. If exporting Epson products or our associated technologies, please be sure to comply with the Foreign Exchange and Foreign Trade Control Act in Japan, Export Administration Regulations in the U.S.A (EAR) and other export-related laws and regulations in Japan and any other countries and to follow their required procedures.
- Epson assumes no responsibility for any damages (whether direct or indirect) caused by or in relation with your non-compliance with the terms and conditions in this document or for any damages (whether direct or indirect) incurred by any third party that you give, transfer or assign Epson products.
- For more details or other concerns about this document, please contact our sales representative.
- Company names and product names listed in this document are trademarks or registered trademarks of their respective companies.