

## MHz Range Crystal unit

- Package size (2.0 mm × 1.6 mm × 0.5 mm)
- Fundamental mode
- Reference weight Typ.7.0 mg

### [ 1 ] Product Number / Product Name / Marking

(1-1) Product Number / Ordering Code

**Q22FA12800140xx**

Last 2 digits code(xx) defines Quantity.

The standard is "18", 5 000 pcs/Reel.

(1-2) Product Name / Model Name

FA-128 26.000000 MHz 9.0 +10.0-10.0

### [ 2 ] Absolute maximum ratings

Parameter	Symbol	Specifications			Unit	Conditions
		Min.	Typ.	Max.		
Storage temperature	T_stg	-40	-	+125	°C	Storage as single product
Operating temperature range	T_use	-40	-	+105	°C	-

### [ 3 ] Specifications(characteristics)

Parameter	Symbol	Specifications			Unit	Conditions
		Min.	Typ.	Max.		
Nominal frequency	f_nom	-	26.000000	-	MHz	Fundamental
Frequency tolerance	f_tol	-10	-	+10	x 10 <sup>-6</sup>	@+25°C
Frequency Stability over temperature	f_tem	-20	-	+20	x 10 <sup>-6</sup>	-40°C to +85°C
Operating temperature	T_use	-40	-	+85	°C	
Level of drive	DL	-	10	100	μW	Recommended: 10 μW
Load capacitance	CL	-	9	-	pF	
Motional resistance (ESR)	R1	-	-	60	Ω	
Motional capacitance	C1	-	2.28	-	fF	
Motional inductance	L1	-	16.48	-	mH	
Shunt capacitance	C0	-	0.72	-	pF	
Frequency aging	f_age	-1	-	+1	x10 <sup>-6</sup> /yea	@+25°C, First year

[ For other general specifications, please refer to the attached Full Data Sheet below ]

## 2.0 x 1.6 mm size MHz range crystal unit: FA-128

### Features

- Package size: 2.0 x 1.6 mm, t = 0.5 mm Max.
- Frequency range: 19.2 MHz to 54 MHz
- Frequency tolerance (standard):  $\pm 10 \times 10^{-6}$  /  $\pm 30 \times 10^{-6}$  (@+25 °C)
- Frequency vs. temperature characteristics (standard):
  - $\pm 10 \times 10^{-6}$  (-20 °C to +75 °C)
  - $\pm 30 \times 10^{-6}$  (-20 °C to +75 °C)
- ESR:
  - 150  $\Omega$  Max. (19.2 MHz  $\leq$  f\_nom < 20 MHz)
  - 100  $\Omega$  Max. (20 MHz  $\leq$  f\_nom < 24 MHz)
  - 80  $\Omega$  Max. (24 MHz  $\leq$  f\_nom < 26 MHz)
  - 60  $\Omega$  Max. (26 MHz  $\leq$  f\_nom  $\leq$  54 MHz)

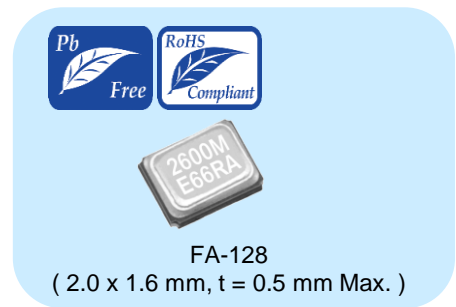

### Applications

- Small communication module for consumer and industrial applications
- Wearable devices
- Clock for MCU

### Description

The FA-128 has been commercialized as a reference clock for communication modules, which requires high accuracy, and as a clock for wireless communication and microcomputers for applications that require miniaturization (TWS (True Wireless Stereo), Smart Watch, etc.).

The products created using the element processing system technology cultivated over many years contribute to improving the performance of the customer's system.

### Outline Drawing and Terminal Assignment

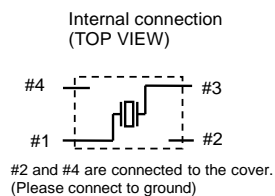
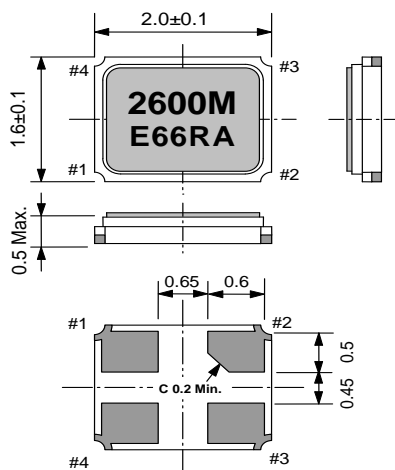

Pin	Connection
#1	X'tal
#2	GND
#3	X'tal
#4	GND

## [ 1 ] Product Number / Product Name

## (1-1) Product Number

Q22FA1280xxx18 (Please contact Epson for details)

## (1-2) Product Name (Standard Form)

FA-128 24.000000MHz 12.0 +10.0-10.0

① ② ③ ④

①Model ②Frequency ③Load capacitance (pF) ④Frequency tolerance ( $\times 10^{-6}$ , +25 °C)

In addition to the mentioned above specification items (① to ④),

please specify the frequency vs. temperature characteristics.

## [ 2 ] Absolute Maximum Ratings

Item	Symbol	Rating value			Unit	Note
		Min.	Typ.	Max.		
Storage temperature range	T_stg	-40	-	+125	°C	Satisfy environmental characteristics specifications

## [ 3 ] Operating Conditions

Item	Symbol	Rating value			Unit	Note
		Min.	Typ.	Max.		
Operating temperature range	T_use	-40	-	+85	°C	Please contact Epson
		-40	-	+105		
Level of drive	DL	1		200	μW	Recommended: 10 μW

## [ 4 ] Static Characteristics

Item	Symbol	Specifications	Unit	Condition / Remarks
Nominal frequency range	f_nom	19.2000 to 54.000	MHz	
Frequency tolerance (Standard)	f_tol	±10 ±30	$\times 10^{-6}$	T_use = +25 °C ± 3 °C DL = 100 μW Does not include frequency aging Please contact Epson for requirements not listed in the specifications
Frequency vs. temperature characteristics (Standard)	f_tem	±10 ±30	$\times 10^{-6}$	Reference at T_use = +25 °C ± 3 °C -20 °C to +75 °C Please contact Epson for requirements not listed in the specifications
Load capacitance	CL	6 to ∞	pF	Please specify
Motional resistance (ESR)	R1	Table 1.	Ω	π circuit IEC 60444-2 T_use = Operating temperature range DL = 100 μW
Shunt capacitance	C0	3.0 Max.	pF	
Frequency aging	f_age	±1 Max. (19.2 MHz ≤ f_nom < 40 MHz) ±2 Max. (40 MHz ≤ f_nom ≤ 54 MHz)	$\times 10^{-6}$	T_use = +25 °C ± 3 °C First year

Table 1.

Frequency	R1
19.2 MHz ≤ f_nom < 20 MHz	150 Ω Max.
20 MHz ≤ f_nom < 26 MHz	100 Ω Max.
24 MHz ≤ f_nom < 26 MHz	80 Ω Max.
26 MHz ≤ f_nom ≤ 54 MHz	60 Ω Max.

## [ 5 ] Example of Frequency Temperature Characteristics

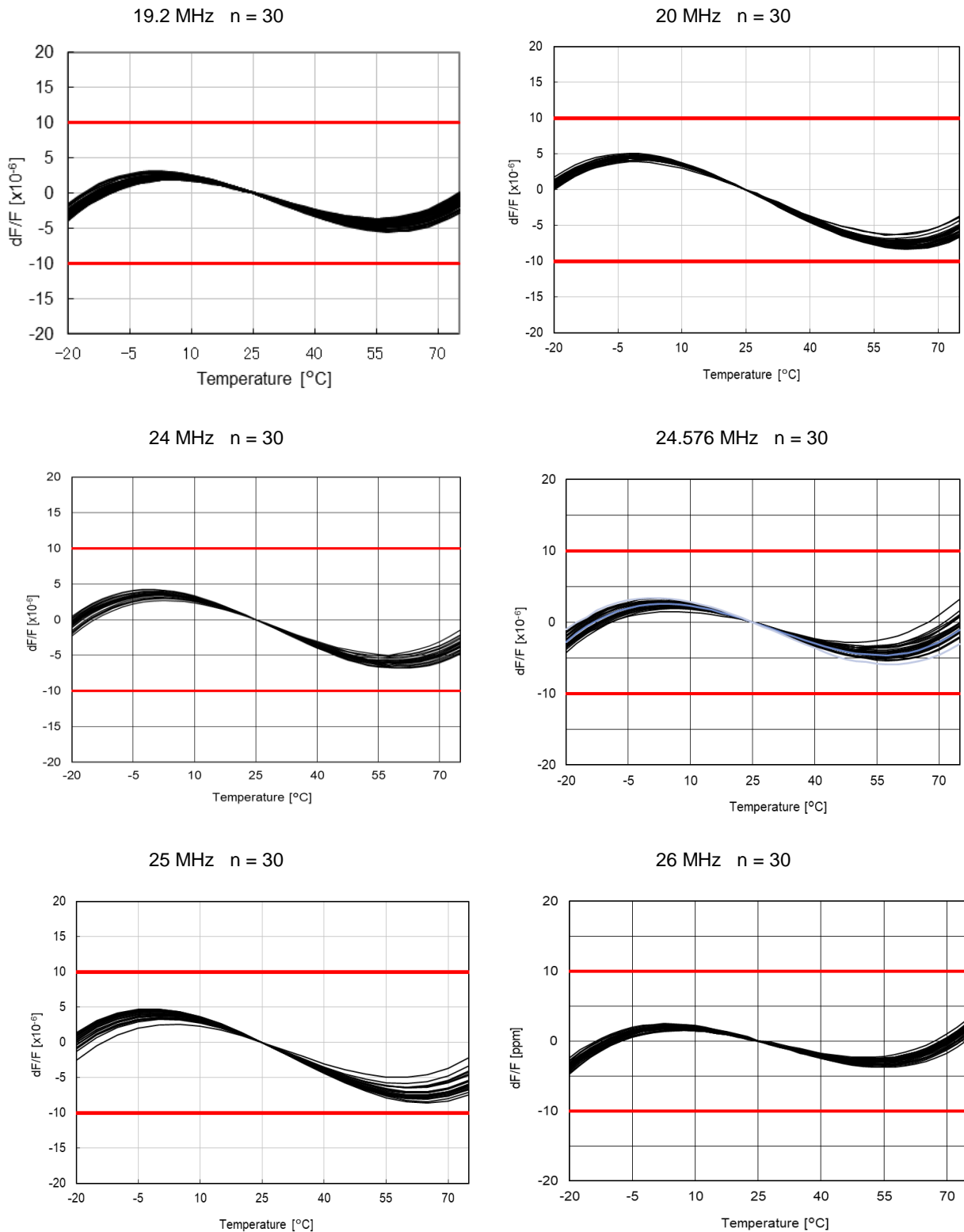

27.12 MHz n = 30

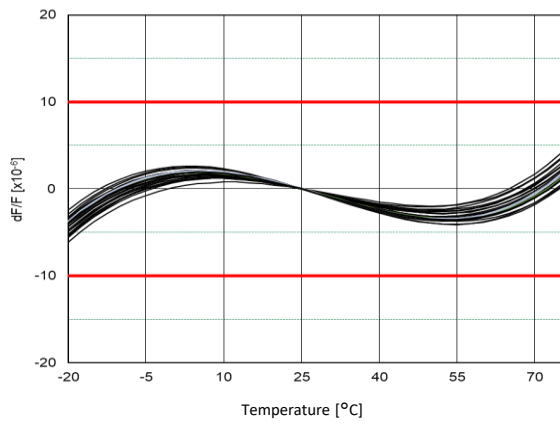

32 MHz n = 30

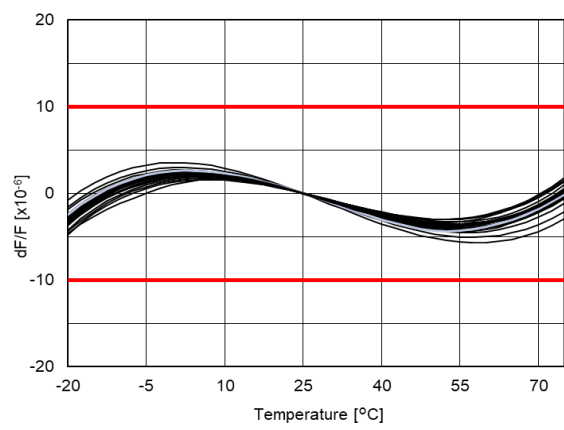

37.4 MHz n = 30

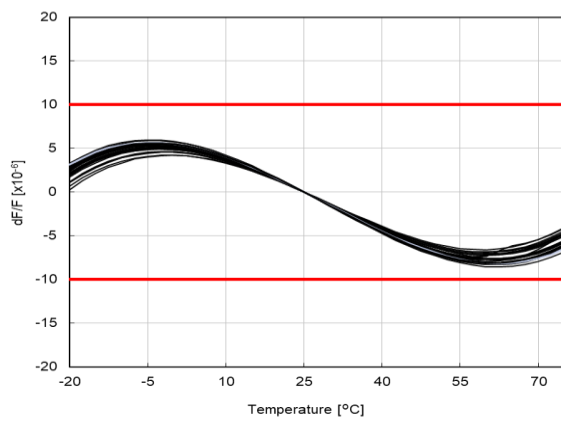

38.4 MHz n = 30

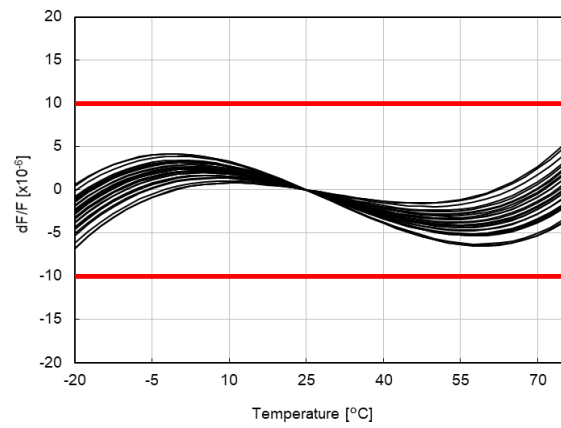

40 MHz n = 30

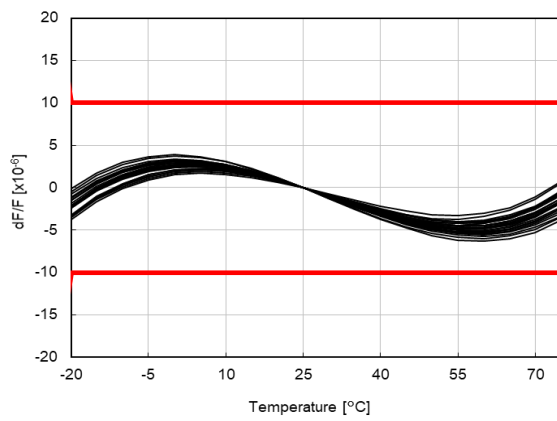

48 MHz n = 30

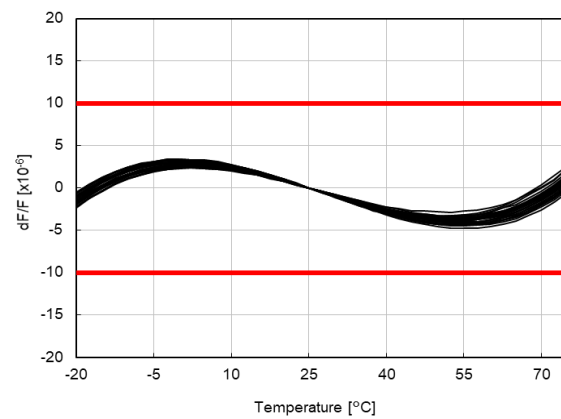

52 MHz n = 30

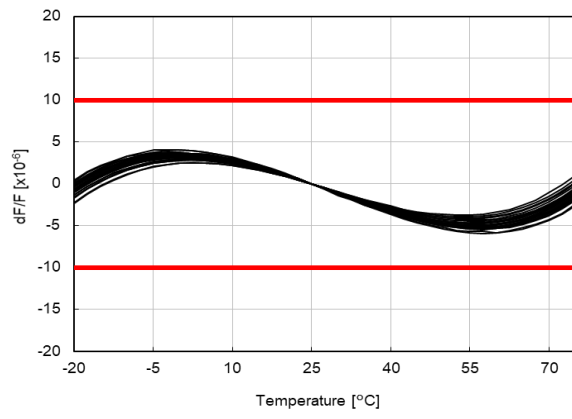

[ 6 ] Marking Description

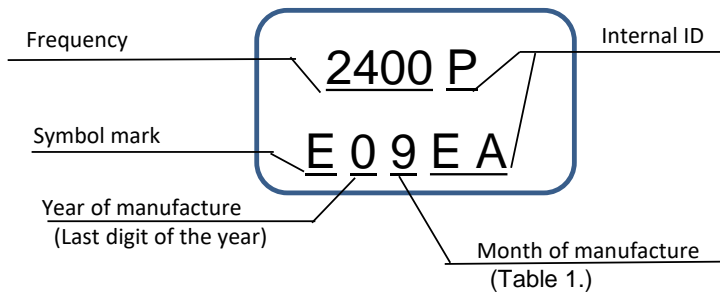
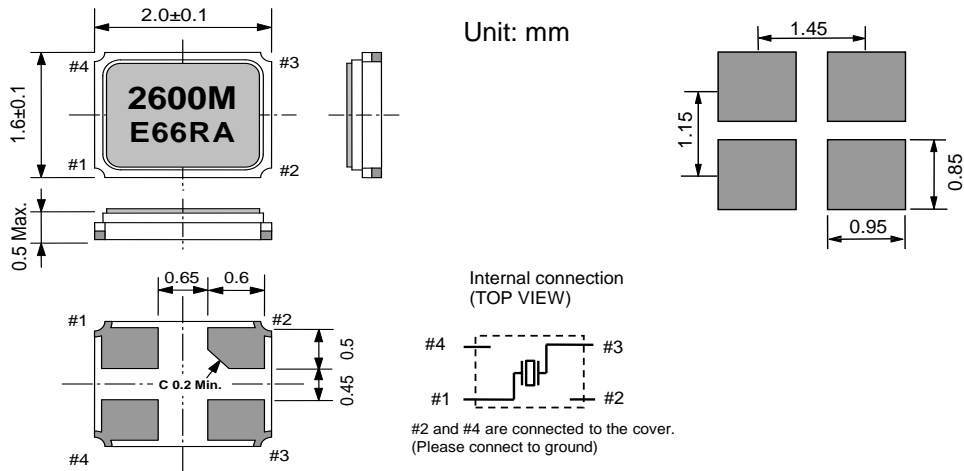

Table 1. Month of manufacture

Month	Jan	Feb	Mar	Apr	May	Jun	Jul	Aug	Sep	Oct	Nov	Dec
Code	1	2	3	4	5	6	7	8	9	X	Y	Z

[ 7 ] Outline Drawing and Recommended Footprint



Pin	Connection
#1	X'tal
#2	GND
#3	X'tal
#4	GND

Reference weight Typ.: 7 mg

Terminal coating: Au plating

## [ 8 ] Moisture Sensitivity Level

Parameter	Specification	Conditions
MSL	LEVEL1	JEDEC J-STD-020D.01

## [ 9 ] Reflow Profile (JEDEC J-STD-020D.01)

Temperature [ °C ]

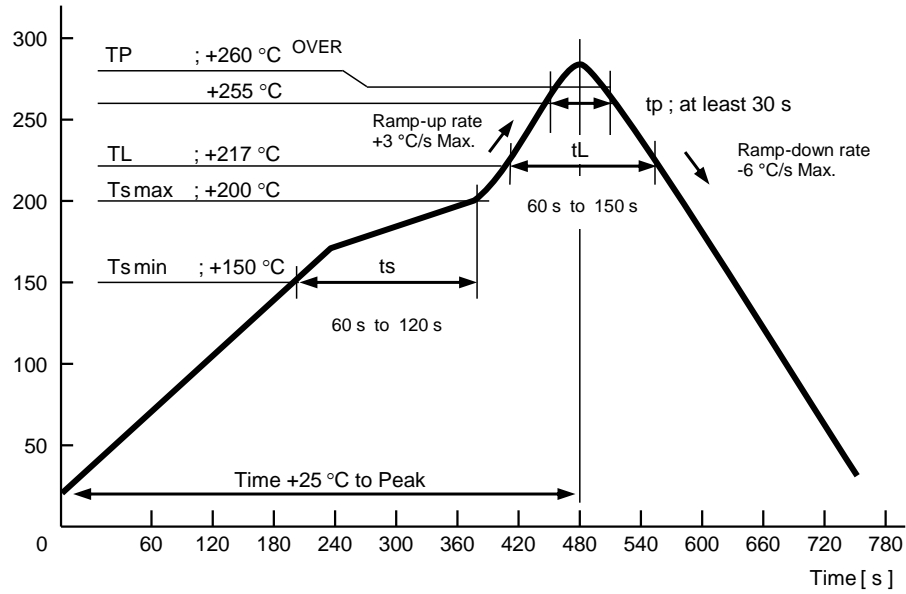



[ 10 ] Packing Information

(1) Packing Quantity

The last two digits of the Product Number (Q22FA1280xxxxxx) are a code that defines the packing quantity.  
The standard is "18" for a 5 000 pcs / Reel.

(2) Taping Specification

Subject to EAI-481, IEC 60286 and JIS C0806

(2-1) Tape Dimensions

Carrier Tape Material : PS (Polystyrene)

Top Tape Material : PET (Polyethylene Terephthalate) + PE (Polyethylene)

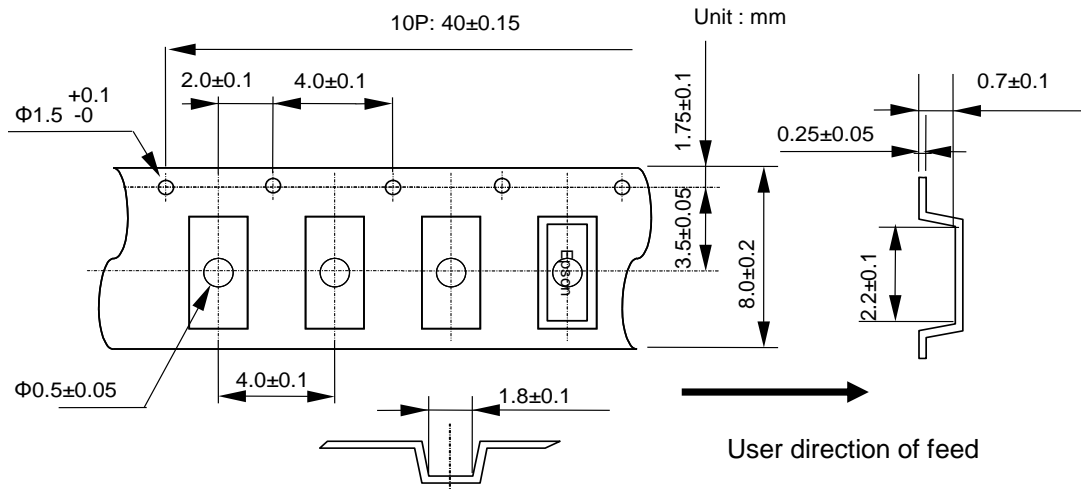

(2-2) Reel Dimensions

Center Material : PS (Polystyrene)

Reel Material : PS (Polystyrene)

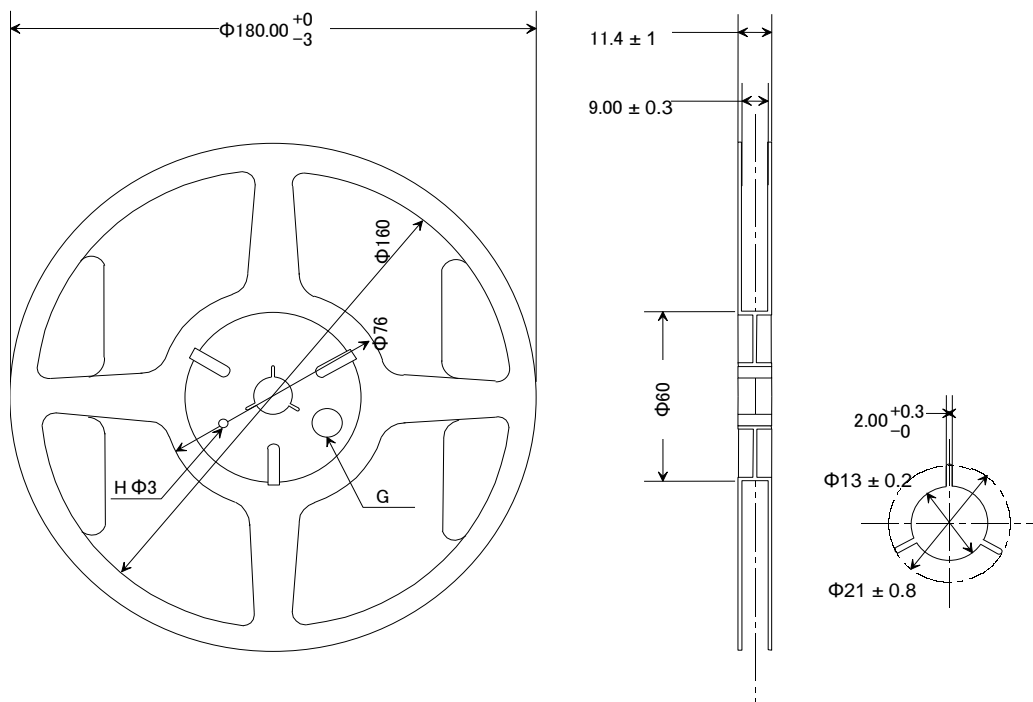

## [ 11 ] Handling Precautions

Prior to using this product, please carefully read the section entitled "Precautions" on our Web site (<https://www5.epsondevice.com/en/information/#precaution>) for instructions on how to handle and use the product properly to ensure optimal performance of the product in your equipment.

Before using the product under any conditions other than those specified therein, please consult with us to verify and confirm that the performance of the product will not be negatively affected by use under such conditions.

In addition to the foregoing precautions, in order to avoid the deteriorating performance of the product, we strongly recommend that you DO NOT use the product under ANY of the following conditions:

1. Max three (3) times re-flow is allowed. Its recommended to manually solder when not enough/no solder detected. (Using soldering iron at +350 °C Max × within 5 seconds)
2. Patterning on a board should follow our company recommended pattern.
3. Too much exciting shock or vibration may cause deterioration on damage.  
The product may damage depends on the condition such as a shock in assembly machinery.  
Please check your process condition in advance to minimize and maintain the shock level.
4. It is recommended to do patterning to the oscillator as short as possible. Abnormal oscillation may happened if the line is too long.
5. Condensation may occur when products are used/stored under remarkable temperature change.
6. This product may be affected to ultrasonic cleaning. It is depends on the cleaning conditions (Cleaning machine type/power/time/content/position etc.). The warranty will not cover any damage due to this type of usage.  
Check conditions prior to use.
7. When the substrate of oscillation become dewy, the crystal frequency is changed or stopped.  
Please use under without the dewfall.
8. Applying excessive excitation Drive Level to the crystal Unit may cause deterioration damage.
9. Few data or readings taken at user side may be different from our company's data. Confirmation of the different value is necessary before application.
10. To avoid malfunction, no pattern across or near the crystal is allowed.
11. Start up time of oscillation may be increased or no oscillation may occur unless adequate negative resistance is allocated in the oscillation circuit In order to avoid this, please provide enough negative resistance to the circuit design.

How to check the negative resistance.

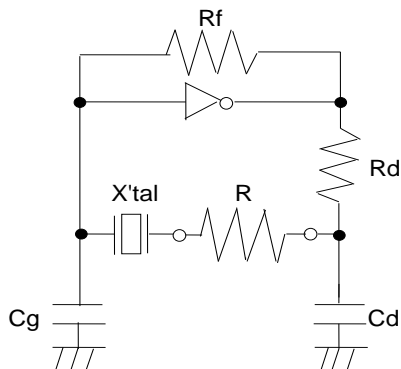

- 1) Insert a pure resistance R in series with the X'tal.
- 2) Adjust R and find the maximum R value that starts oscillation.
- 3) Check the value of R in the oscillation state of 2).  
Negative resistance of the circuit  $|-R| =$   
R + Series resistance value R1 of the X'tal
- 4) Negative resistance  $|-R|$  guideline:  
 $|-R| > R1 \text{ Max. } \times 5$

12. Please refer to packing specification for the storage method and packing standard.

## PROMOTION OF ENVIRONMENTAL MANAGEMENT SYSTEM CONFORMING TO INTERNATIONAL STANDARDS

At Seiko Epson, all environmental initiatives operate under the Plan-Do-Check-Action (PDCA) cycle designed to achieve continuous improvements. The environmental management system (EMS) operates under the ISO 14001 environmental management standard.

All of our major manufacturing and non-manufacturing sites, in Japan and overseas, completed the acquisition of ISO 14001 certification.



ISO 14000 is an international standard for environmental management that was established by the International Standards Organization in 1996 against the background of growing concern regarding global warming, destruction of the ozone layer, and global deforestation.

## WORKING FOR HIGH QUALITY

In order provide high quality and reliable products and services than meet customer needs, Seiko Epson made early efforts towards obtaining ISO9000 series certification and has acquired ISO9001 for all business establishments in Japan and abroad. We have also acquired IATF 16949 certification that is requested strongly by major manufacturers as standard.

IATF 16949 is the international standard that added the sector-specific supplemental requirements for automotive industry based on ISO9001.

### ■ Explanation of marks used in this datasheet

	<p>● <b>Pb free.</b></p>
	<p>● <b>Complies with EU RoHS directive.</b>                  *About the products without the Pb-free mark.                  Contains Pb in products exempted by EU RoHS directive                  (Contains Pb in sealing glass, high melting temperature type solder or other)</p>

NOTICE: PLEASE READ CAREFULLY BELOW BEFORE THE USE OF THIS DOCUMENT ©Seiko Epson Corporation 2020

- The content of this document is subject to change without notice. Before purchasing or using Epson products, please contact with sales representative of Seiko Epson Corporation ("Epson") for the latest information and be always sure to check the latest information published on Epson's official web sites and resources.
- This document may not be copied, reproduced, or used for any other purposes, in whole or in part, without Epson's prior consent.
- Information provided in this document including, but not limited to application circuits, programs and usage, is for reference purpose only. Epson makes no guarantees against any infringements or damages to any third parties' intellectual property rights or any other rights resulting from the information. This document does not grant you any licenses, any intellectual property rights or any other rights with respect to Epson products owned by Epson or any third parties.
- Using Epson products, you shall be responsible for safe design in your products; that is, your hardware, software, and/or systems shall be designed enough to prevent any critical harm or damages to life, health or property, even if any malfunction or failure might be caused by Epson products. In designing your products with Epson products, please be sure to check and comply with the latest information regarding Epson products (including, but not limited to this document, specifications, data sheets, manuals, and Epson's web site). Using technical contents such as product data, graphic and chart, and technical information, including programs, algorithms and application circuit examples under this document, you shall evaluate your products thoroughly both in stand-alone basis and within your overall systems. You shall be solely responsible for deciding whether to adopt/use Epson products with your products.
- Epson has prepared this document carefully to be accurate and dependable, but Epson does not guarantee that the information is always accurate and complete. Epson assumes no responsibility for any damages you incurred due to any misinformation in this document.
- No dismantling, analysis, reverse engineering, modification, alteration, adaptation, reproduction, etc., of Epson products is allowed.
- Epson products have been designed, developed and manufactured to be used in general electronic applications and specifically requires particular quality or extremely high reliability in order to refrain from causing any malfunction or failure leading to critical harm to life and health, serious property damage, or severe impact on society, including, but not limited to listed below ("Specific Purpose"). Therefore, you are strongly advised to use Epson products only for the Anticipated Purpose. Should you desire to purchase and use Epson products for Specific Purpose, Epson makes no warranty and disclaims with respect to Epson products, whether express or implied, including without limitation any implied warranty of merchantability or fitness for any Specific Purpose. Please be sure to contact our sales representative in advance, if you desire Epson products for Specific Purpose:  
 Space equipment (artificial satellites, rockets, etc.)/ Transportation vehicles and their control equipment (automobiles, aircraft, trains, ships, etc.) / Medical equipment/ Relay equipment to be placed on sea floor/ Power station control equipment / Disaster or crime prevention equipment/Traffic control equipment/ Financial equipment  
 Other applications requiring similar levels of reliability as the above
- Epson products listed in this document and our associated technologies shall not be used in any equipment or systems that laws and regulations in Japan or any other countries prohibit to manufacture, use or sell. Furthermore, Epson products and our associated technologies shall not be used for the purposes of military weapons development (e.g. mass destruction weapons), military use, or any other military applications. If exporting Epson products or our associated technologies, please be sure to comply with the Foreign Exchange and Foreign Trade Control Act in Japan, Export Administration Regulations in the U.S.A (EAR) and other export-related laws and regulations in Japan and any other countries and to follow their required procedures.
- Epson assumes no responsibility for any damages (whether direct or indirect) caused by or in relation with your non-compliance with the terms and conditions in this document or for any damages (whether direct or indirect) incurred by any third party that you give, transfer or assign Epson products.
- For more details or other concerns about this document, please contact our sales representative.
- Company names and product names listed in this document are trademarks or registered trademarks of their respective companies.