

REL-OR3/LDP-125DC/3X21 - Single relay



2909207

<https://www.phoenixcontact.com/us/products/2909207>

Please be informed that the data shown in this PDF document is generated from our online catalog. Please find the complete data in the user documentation. Our general terms of use for downloads are valid.



Plug-in octal relays with power contacts, 3 changeover contacts, test button, freewheeling diode, mechanical switch position indicator, polarity A1+, A2-, input voltage: 125 V DC

Commercial data

Item number	2909207
Packing unit	10 pc
Minimum order quantity	10 pc
Sales key	C460
Product key	CK6193
Catalog page	Page 308 (C-5-2019)
GTIN	4055626360171
Weight per piece (including packing)	88.97 g
Weight per piece (excluding packing)	88.97 g
Customs tariff number	85364900
Country of origin	PL

Technical data

Notes

General	The outputs are not suitable for switching different outer conductors.
General	Do not use to separate SELV / PELV circuits from other circuits, because safe isolation is not guaranteed.

Product properties

Product type	Single relay
Operating mode	100% operating factor
Mechanical service life	approx. 2×10^7 cycles

Insulation characteristics

Insulation	Basic insulation
------------	------------------

Insulation characteristics

Insulation	Basic insulation
Overvoltage category	III
Pollution degree	3

Electrical properties

Maximum power dissipation for nominal condition	1.44 W
Test voltage (Winding/contact)	2.5 kV _{rms} (50 Hz, 1 min., winding/contact)
Test voltage (Changeover contact/changeover contact)	2.5 kV _{rms} (50 Hz, 1 min., changeover contact/changeover contact)
Rated insulation voltage	250 V AC
Rated surge voltage	4 kV

Input data

Coil side

Nominal input voltage U_N	125 V DC
Input voltage range	106.25 V DC ... 137.5 V DC (see diagram)
Drive and function	monostable
Drive (polarity)	non-polarized
Typical input current at U_N	14 mA
Input power dissipation for U_N	1.75 W
Typical response time	18 ms
Typical release time	20 ms
Protective circuit	Freewheeling diode
Status display	Yellow LED

Output data

Switching

REL-OR3/LDP-125DC/3X21 - Single relay



2909207

<https://www.phoenixcontact.com/us/products/2909207>

Contact switching type	3 changeover contacts
Type of switch contact	Single contact
Contact material	AgNi
Maximum switching voltage	250 V DC
	440 V AC
Minimum switching voltage	10 V (At 24 mA)
Limiting continuous current	10 A
Maximum inrush current	30 A (20 ms, N/O contacts)
Min. switching current	10 mA (at 24 V)
Interrupting rating (ohmic load) max.	240 W (at 24 V DC)
	124 W (at 48 V DC)
	108 W (at 60 V DC)
	52 W (at 110 V DC)
	48 W (at 220 V DC)
	2500 VA (for 250 V AC)
Motor load according to UL 508	1/2 HP, 240 V AC (N/O contact)

Connection data

Connection method	Plug-in connection
-------------------	--------------------

Dimensions

Width	35 mm
Height	35 mm
Depth	54.4 mm

Environmental and real-life conditions

Ambient conditions

Degree of protection	RT I
Degree of protection (Installation location)	≥ IP54 (Installation location)
Ambient temperature (operation)	-40 °C ... 70 °C
Ambient temperature (storage/transport)	-40 °C ... 85 °C
Altitude	≤ 2000 m

Approvals

Corrosive gas test

Identification	ISA-S71.04. G3 Harsh Group
	EN 60068-2-60

Standards and regulations

Standards/regulations	IEC 60664
	IEC 61810

Mounting

Mounting position	any
-------------------	-----

Drawings

Diagram

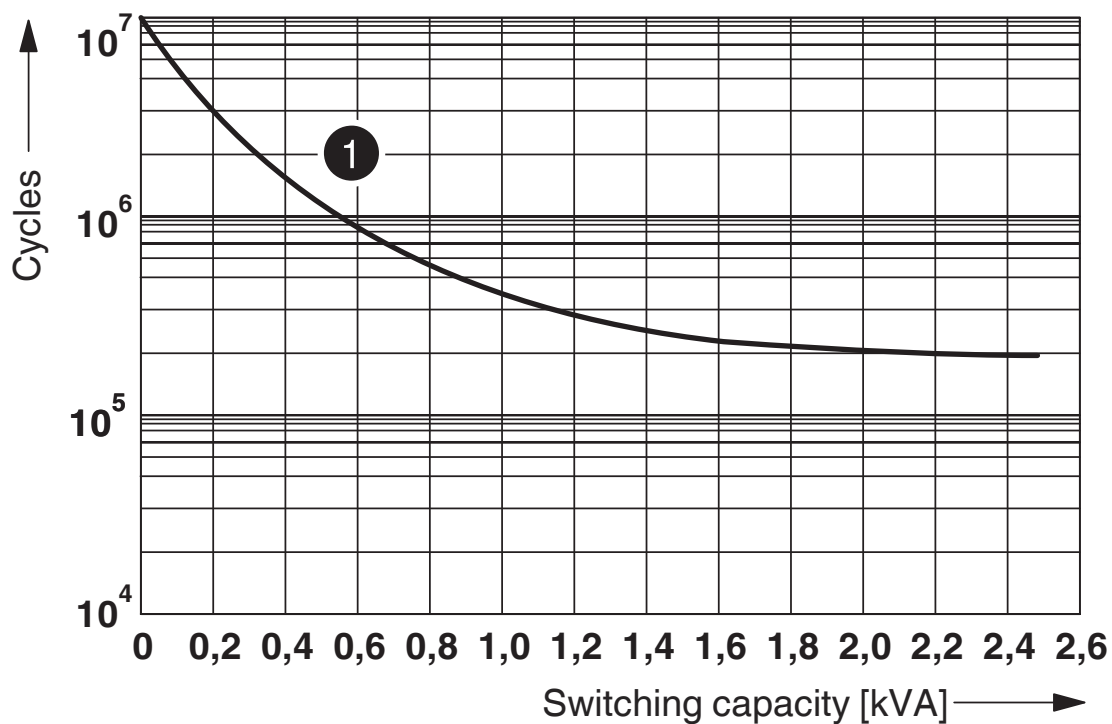

250 V AC, ohmic load

Electrical service life

Circuit diagram

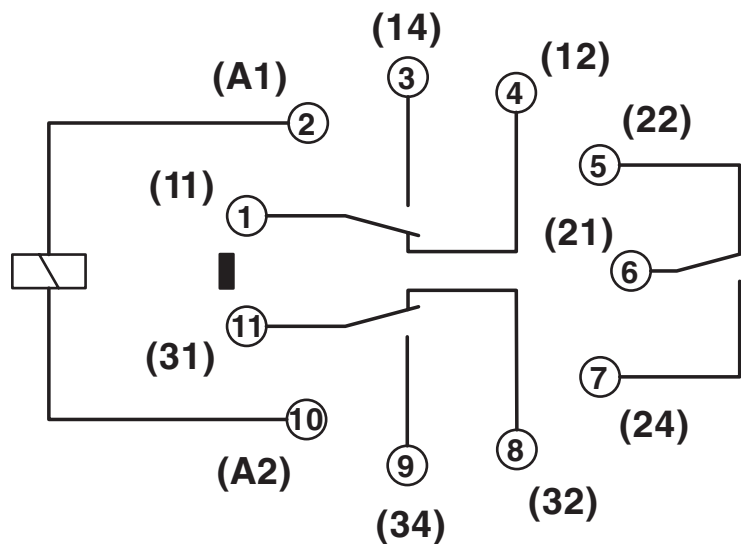

Diagram

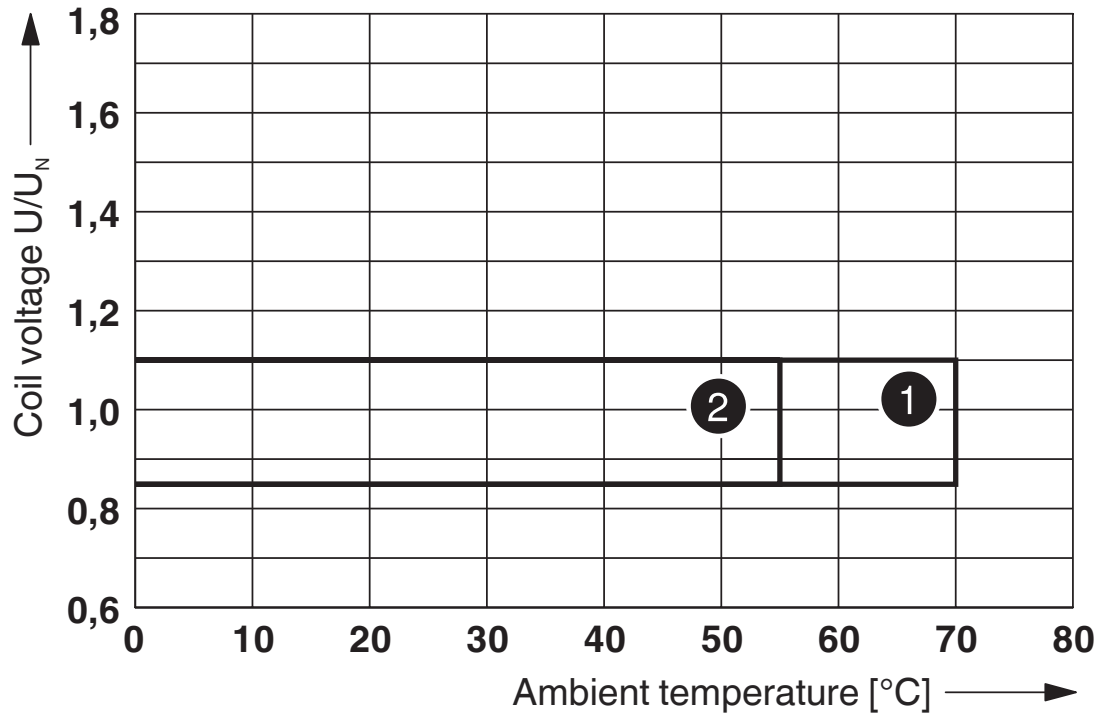

- ① DC coils
- ② AC coils

Operating voltage range

Diagram

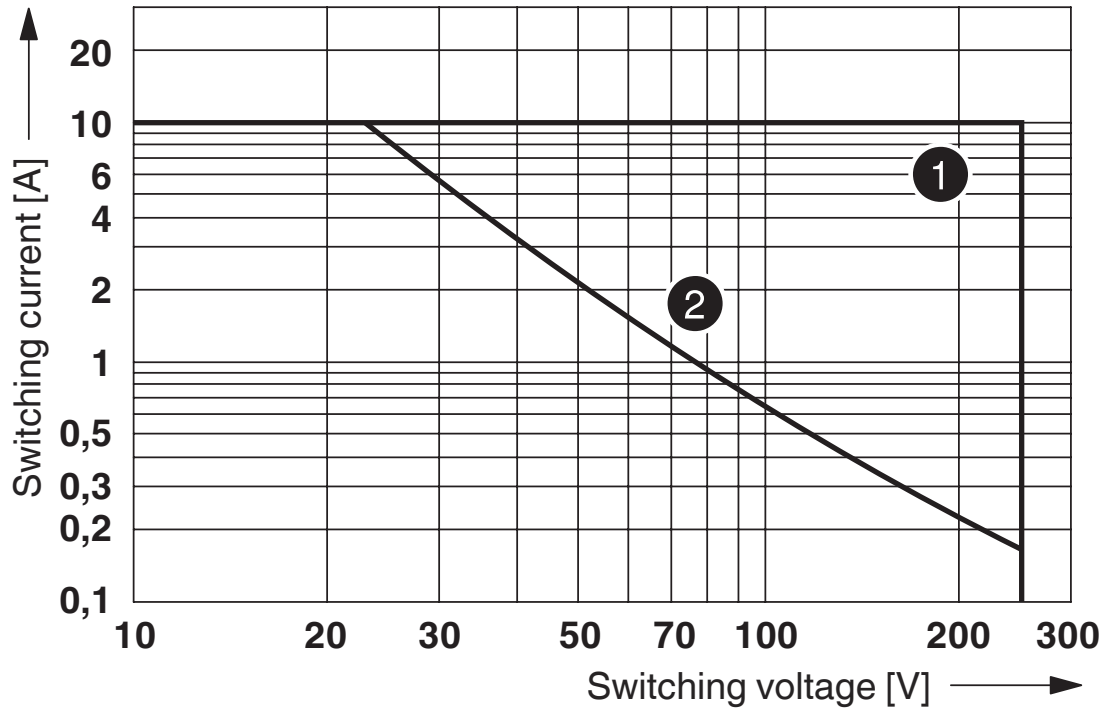

- ① AC, ohmic load
- ② DC, ohmic load

Interrupting rating

Diagram

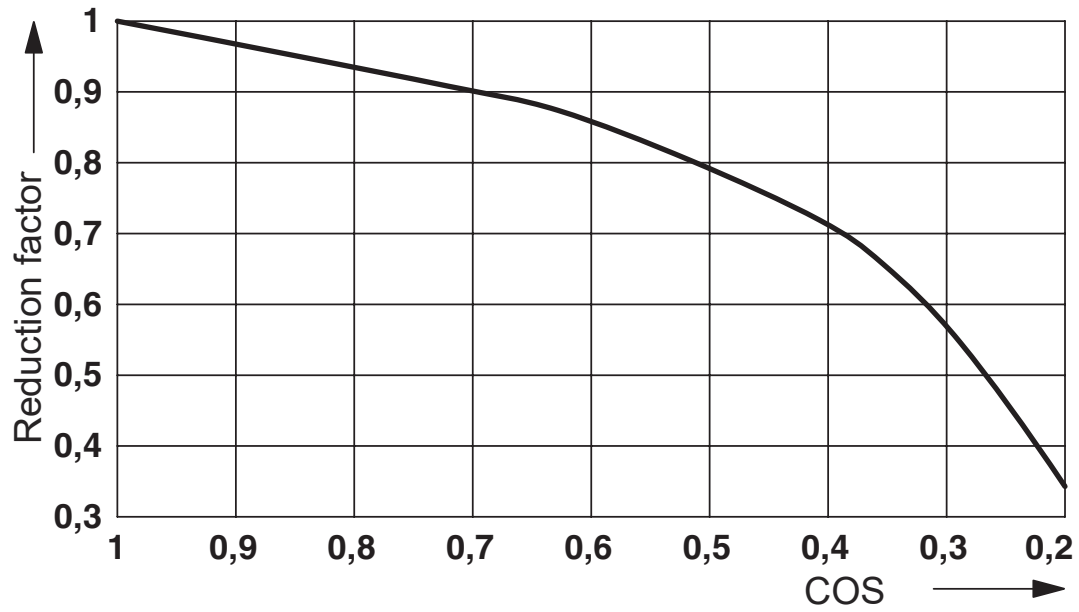

Service life reduction factor

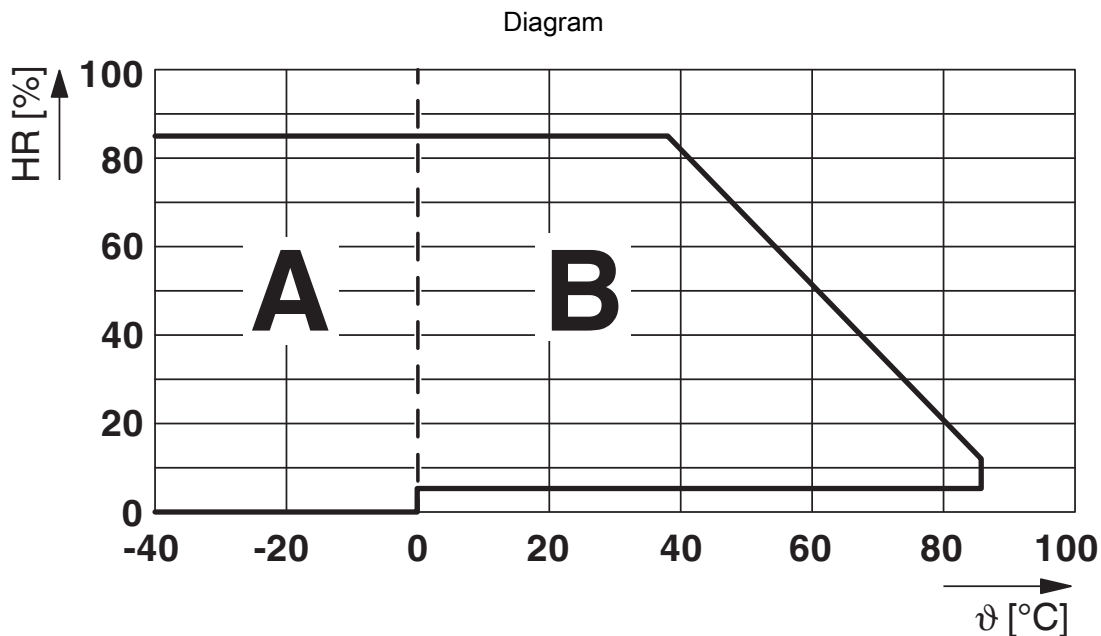

Permissible humidity for operation and storage.

The maximum permissible ambient temperature as specified in the data sheet must be observed.

Area A: Ice buildup at ambient temperatures $\leq 0^\circ\text{C}$ must be prevented

Area B: Condensation at ambient temperatures $> 0^\circ\text{C}$ must be prevented

On 30 full days that are naturally distributed across an entire year, a humidity level of 95% is permissible at an ambient temperature $\leq 25^\circ\text{C}$.

REL-OR3/LDP-125DC/3X21 - Single relay



2909207

<https://www.phoenixcontact.com/us/products/2909207>

Approvals

To download certificates, visit the product detail page: <https://www.phoenixcontact.com/us/products/2909207>



CSA

Approval ID: 256725



cUL Recognized

Approval ID: FILE E 172140



UL Recognized

Approval ID: FILE E 172140



EAC

Approval ID: TR_TS_D_00573_c



EAC

Approval ID: RU*C-DE.*08.B.00010

cULus Recognized

REL-OR3/LDP-125DC/3X21 - Single relay



2909207

<https://www.phoenixcontact.com/us/products/2909207>

Classifications

ECLASS

ECLASS-11.0	27371601
ECLASS-12.0	27371601
ECLASS-13.0	27371601

ETIM

ETIM 9.0	EC001437
----------	----------

UNSPSC

UNSPSC 21.0	39122300
-------------	----------

REL-OR3/LDP-125DC/3X21 - Single relay



2909207

<https://www.phoenixcontact.com/us/products/2909207>

Environmental product compliance

China RoHS	Environmentally friendly use period: unlimited = EFUP-e
	No hazardous substances above threshold values

REL-OR3/LDP-125DC/3X21 - Single relay



2909207

<https://www.phoenixcontact.com/us/products/2909207>

Mandatory accessories

RIF-3-BPT/3X21 - Relay base

2900938

<https://www.phoenixcontact.com/us/products/2900938>

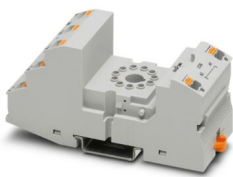

Relay base RIF-3..., for octal relays with 3 changeover contacts, Push-in connection, plug-in option for input/interference suppression modules, for mounting on NS 35/7,5

RIF-3-BSC/3X21 - Relay base

2900936

<https://www.phoenixcontact.com/us/products/2900936>

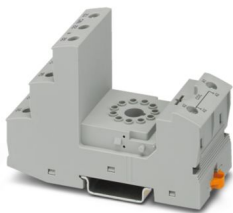

RIF-3... relay base, for octal relay with 3 changeover contacts, screw connection, plug-in option for input/interference suppression modules, for mounting on NS 35/7,5

Phoenix Contact 2024 © - all rights reserved

<https://www.phoenixcontact.com>

Phoenix Contact USA
586 Fulling Mill Road
Middletown, PA 17057, United States
(+717) 944-1300
info@phoenixcon.com