

LSF-SMD 3.50/12/135 SN BK RL

Weidmüller Interface GmbH & Co. KG

Klingenbergstraße 26

D-32758 Detmold

Germany

www.weidmueller.com

Product image

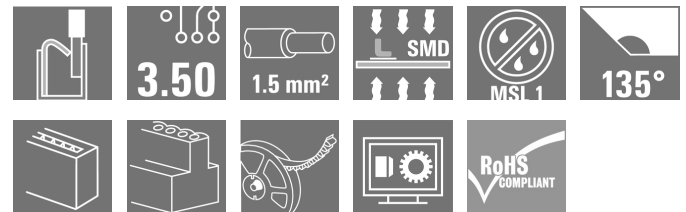
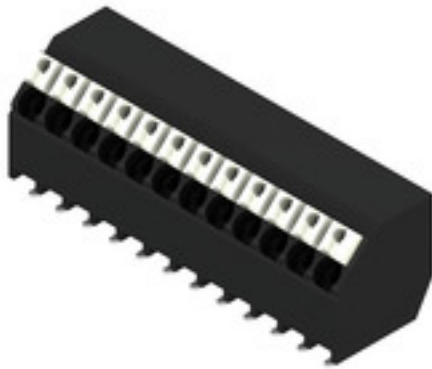

The innovative quick connector - simple, safe and economical:

PCB terminals with spring connection and direct PUSH IN technology. A milestone in connection technology.

Amazingly simple and simply amazing in practice:

- Connect and easily detach solid wires or wires with wire-end ferrules without using tools
- Processed automatically in the reflow or vapour phase
- Potentials and clamping points marked clearly by coloured push buttons

World-class design-in and processing phases, and suitable for a vast range of applications.

PCB terminal for fully automatic assembly using reflow soldering (SMD), with PUSH IN wire connections. Conductor insertion and slider operation from the same direction (TOP).

- **Solid & flexible conductors with wire-end ferrules need only to be inserted and they are ready.**
- **When connecting stranded wires without wire-end ferrules the actuating element is used to open the terminal point**
- **Intuitive handling – since the wire-entry area and handling area are clearly separated.**
- **Packaged in tape-on-reel**
- **Conductor outlet direction 135°**

General ordering data

| | |
|--------------|--|
| Version | Printed circuit board terminals, 3.50 mm, Number of poles: 12, 135°, black, PUSH IN with actuator, Clamping range, max.: 1.5 mm², Tape |
| Order No. | 1473430000 |
| Type | LSF-SMD 3.50/12/135 SN BK RL |
| GTIN (EAN) | 4050118279795 |
| Qty. | 210 pc(s). |
| Product data | IEC: 320 V / 12 A / 0.2 - 1.5 mm² UL: 300 V / 12 A / AWG 28 - AWG 14 |
| Packaging | Tape |

LSF-SMD 3.50/12/135 SN BK RL

Weidmüller Interface GmbH & Co. KG

Klingenbergstraße 26

D-32758 Detmold

Germany

www.weidmueller.com

Technical data

Dimensions and weights

| | | | |
|--------------------------|------------|-----------------|------------|
| Depth | 12.7 mm | Depth (inches) | 0.5 inch |
| Height | 14.45 mm | Height (inches) | 0.569 inch |
| Height of lowest version | 14.45 mm | Width | 42.7 mm |
| Width (inches) | 1.681 inch | Net weight | 9.71 g |

Temperatures

| | |
|----------------------------------|--------|
| Continuous operating temp., max. | 120 °C |
|----------------------------------|--------|

System parameters

| | | | |
|--|------------------------------|--|-----------------------|
| Product family | OMNIMATE Signal - series LSF | Wire connection method | PUSH IN with actuator |
| Mounting onto the PCB | SMD solder connection | Conductor outlet direction | 135° |
| Pitch in mm (P) | 3.5 mm | Pitch in inches (P) | 0.138 " |
| Number of poles | 12 | Pin series quantity | 1 |
| Fitted by customer | No | Number of rows | 1 |
| Coplanarity: | 100 µm | Number of solder pins per pole | 2 |
| Stripping length | 8 mm | L1 in mm | 38.5 mm |
| L1 in inches | 1.518 " | Touch-safe protection acc. to DIN VDE 0470 | IP 20 |
| Touch-safe protection acc. to DIN VDE 57 106 | Safe from finger touch | Protection degree | IP20 |
| Volume resistance | 1.60 mΩ | | |

Material data

| | | | |
|---------------------------------------|------------------|---------------------------------------|----------|
| Insulating material | LCP GF | Colour | black |
| Colour chart (similar) | RAL 9011 | Insulating material group | IIIa |
| Comparative Tracking Index (CTI) | ≥ 175 | Moisture Level (MSL) | 1 |
| UL 94 flammability rating | V-0 | Contact material | Cu-alloy |
| Layer structure of solder connection | 4...6 µm Sn matt | Storage temperature, min. | -40 °C |
| Storage temperature, max. | 70 °C | Operating temperature, min. | -50 °C |
| Operating temperature, max. | 120 °C | Temperature range, installation, min. | -30 °C |
| Temperature range, installation, max. | 120 °C | | |

Conductors suitable for connection

| | |
|---|----------------------|
| Clamping range, min. | 0.13 mm ² |
| Clamping range, max. | 1.5 mm ² |
| Wire connection cross section AWG, min. | AWG 28 |
| Wire connection cross section AWG, max. | AWG 14 |
| Solid, min. H05(07) V-U | 0.2 mm ² |
| Solid, max. H05(07) V-U | 1.5 mm ² |
| Flexible, min. H05(07) V-K | 0.2 mm ² |
| Flexible, max. H05(07) V-K | 1.5 mm ² |
| w. plastic collar ferrule, DIN 46228 pt 4, min. | 0.25 mm ² |
| w. plastic collar ferrule, DIN 46228 pt 4, max. | 0.75 mm ² |
| w. wire end ferrule, DIN 46228 pt 1, min. | 0.25 mm ² |
| w. wire end ferrule, DIN 46228 pt 1, max. | 1.5 mm ² |

Creation date February 18, 2024 11:10:26 AM CET

Catalogue status 10.02.2024 / We reserve the right to make technical changes.

2

LSF-SMD 3.50/12/135 SN BK RL

Weidmüller Interface GmbH & Co. KG
 Klingenbergstraße 26
 D-32758 Detmold
 Germany

www.weidmueller.com

Technical data

| | | | |
|--|--|-------------------------------|------------------------------|
| Clampable conductor | Cross-section for conductor connection | Type | fine-wired |
| | | nominal | 0.25 mm ² |
| | wire end ferrule | Stripping length | nominal 10 mm |
| | | Recommended wire-end ferrule | HO,25/12 HBL |
| | Cross-section for conductor connection | Type | fine-wired |
| | | nominal | 0.34 mm ² |
| | wire end ferrule | Stripping length | nominal 10 mm |
| | | Recommended wire-end ferrule | HO,34/12 TK |
| Cross-section for conductor connection | Type | fine-wired | |
| | nominal | 0.5 mm ² | |
| wire end ferrule | Stripping length | nominal 10 mm | |
| | Recommended wire-end ferrule | HO,5/14 OR | |
| Cross-section for conductor connection | Type | fine-wired | |
| | nominal | 0.75 mm ² | |
| wire end ferrule | Stripping length | nominal 10 mm | |
| | Recommended wire-end ferrule | HO,75/14T HBL | |

Reference text Length of ferrules is to be chosen depending on the product and the rated voltage., The outside diameter of the plastic collar should not be larger than the pitch (P)

Rated data acc. to IEC

| | | | |
|---|------------------------|---|------------------|
| tested acc. to standard | IEC 60664-1, IEC 61984 | Rated current, min. number of poles (Tu=20°C) | 12 A |
| Rated current, max. number of poles (Tu=20°C) | 12 A | Rated current, min. number of poles (Tu=40°C) | 12 A |
| Rated current, max. number of poles (Tu=40°C) | 12 A | Rated voltage for surge voltage class / pollution degree II/2 | 320 V |
| Rated voltage for surge voltage class / pollution degree III/2 | 160 V | Rated voltage for surge voltage class / pollution degree III/3 | 160 V |
| Rated impulse voltage for surge voltage class/ pollution degree II/2 | 2.5 kV | Rated impulse voltage for surge voltage class/ pollution degree III/2 | 2.5 kV |
| Rated impulse voltage for surge voltage class/ contamination degree III/3 | 2.5 kV | Short-time withstand current resistance | 3 x 1s with 80 A |

Rated data acc. to CSA

| | | | |
|-----------------------------------|--|-----------------------------------|----------------|
| Institute (CSA) | | Certificate No. (CSA) | 200039-1664286 |
| Rated voltage (Use group B / CSA) | 300 V | Rated voltage (Use group D / CSA) | 300 V |
| Rated current (Use group B / CSA) | 10 A | Rated current (Use group D / CSA) | 10 A |
| Wire cross-section, AWG, min. | AWG 28 | Wire cross-section, AWG, max. | AWG 14 |
| Reference to approval values | Specifications are maximum values, details - see approval certificate. | | |

LSF-SMD 3.50/12/135 SN BK RL

Weidmüller Interface GmbH & Co. KG
 Klingenbergstraße 26
 D-32758 Detmold
 Germany

www.weidmueller.com

Technical data

Rated data acc. to UL 1059

Institute (cURus)



Certificate No. (cURus)

E60693

| | | | |
|---------------------------------------|--|---------------------------------------|--------|
| Rated voltage (Use group B / UL 1059) | 300 V | Rated voltage (Use group D / UL 1059) | 300 V |
| Rated current (Use group B / UL 1059) | 12 A | Rated current (Use group D / UL 1059) | 10 A |
| Wire cross-section, AWG, min. | AWG 28 | Wire cross-section, AWG, max. | AWG 14 |
| Reference to approval values | Specifications are maximum values, details - see approval certificate. | | |

Packing

| | | | |
|-----------------------------|-------------------------------|--------------------------------------|----------|
| ESD Level packaging | static dissipative | Packaging | Tape |
| VPE length | 330 mm | VPE width | 300 mm |
| VPE height | 61 mm | Tape depth (T2) | 15.7 mm |
| Tape width (W) | 56 mm | Tape pocket depth (K0) | 15.2 mm |
| Tape pocket height (A0) | 11.3 mm | Tape pocket width (B0) | 44.06 mm |
| Tape pocket separation (P1) | 20 mm | Tape hole separation (E) | 1.75 mm |
| Tape pocket separation (F) | 26.2 mm | Tape reel diameter \varnothing (A) | 330 mm |
| Surface resistance | $R_s = 10^9 - 10^{12} \Omega$ | | |

Type tests

| | | | |
|-------------------------------|----------------|--|-------------------------------|
| Test: Durability of markings | Test | mark of origin, type identification, pitch, approval marking UL, durability | |
| Test: Clampable cross section | Standard | DIN EN 60999-1 section 7 and 9.1 / 12.00, DIN EN 60947-1 section 8.2.4.5.1 / 12.02 | |
| | Conductor type | Type of conductor and conductor cross-section | solid 0.14 mm ² |
| | | Type of conductor and conductor cross-section | stranded 0.14 mm ² |
| | | Type of conductor and conductor cross-section | solid 1.5 mm ² |
| | | Type of conductor and conductor cross-section | stranded 1.5 mm ² |
| | | Type of conductor and conductor cross-section | AWG 24/1 |
| | | Type of conductor and conductor cross-section | AWG 22/19 |
| | | Type of conductor and conductor cross-section | AWG 16/1 |
| | | Type of conductor and conductor cross-section | AWG 16/19 |
| Evaluation | passed | | |

LSF-SMD 3.50/12/135 SN BK RL

Weidmüller Interface GmbH & Co. KG
 Klingenbergstraße 26
 D-32758 Detmold
 Germany

www.weidmueller.com

Technical data

| | | | | |
|---|----------------|---|-------------------------------|--|
| Test for damage to and accidental loosening of conductors | Standard | DIN EN 60999-1 section 9.4 / 12.00 | | |
| | Requirement | 0.2 kg | | |
| | Conductor type | Type of conductor and conductor cross-section | AWG 24/1 | |
| | | Type of conductor and conductor cross-section | AWG 24/19 | |
| | Evaluation | passed | | |
| | Requirement | 0.3 kg | | |
| | Conductor type | Type of conductor and conductor cross-section | stranded 0.25 mm ² | |
| | | Type of conductor and conductor cross-section | solid 0.5 mm ² | |
| | Evaluation | passed | | |
| | Requirement | 0.4 kg | | |
| | Conductor type | Type of conductor and conductor cross-section | solid 1.5 mm ² | |
| | | Type of conductor and conductor cross-section | stranded 1.5 mm ² | |
| Type of conductor and conductor cross-section | | AWG 16/1 | | |
| Type of conductor and conductor cross-section | | AWG 16/19 | | |
| Evaluation | passed | | | |
| Pull-out test | Standard | DIN EN 60999-1 section 9.5 / 12.00 | | |
| | Requirement | ≥10 N | | |
| | Conductor type | Type of conductor and conductor cross-section | AWG 24/1 | |
| | | Type of conductor and conductor cross-section | AWG 24/19 | |
| | Evaluation | passed | | |
| | Requirement | ≥20 N | | |
| | Conductor type | Type of conductor and conductor cross-section | stranded 0.25 mm ² | |
| | | Type of conductor and conductor cross-section | H05V-U0.5 | |
| | Evaluation | passed | | |
| | Requirement | ≥40 N | | |
| | Conductor type | Type of conductor and conductor cross-section | H07V-U1.5 | |
| | | Type of conductor and conductor cross-section | H07V-K1.5 | |
| Type of conductor and conductor cross-section | | AWG 16/1 | | |
| Type of conductor and conductor cross-section | | AWG 16/19 | | |
| Evaluation | passed | | | |

LSF-SMD 3.50/12/135 SN BK RL

Weidmüller Interface GmbH & Co. KG
 Klingenbergstraße 26
 D-32758 Detmold
 Germany

www.weidmueller.com

Technical data

Classifications

| | | | |
|-------------|-------------|-------------|-------------|
| ETIM 6.0 | EC002643 | ETIM 7.0 | EC002643 |
| ETIM 8.0 | EC002643 | ETIM 9.0 | EC002643 |
| ECLASS 9.0 | 27-44-04-01 | ECLASS 9.1 | 27-44-04-01 |
| ECLASS 10.0 | 27-44-04-01 | ECLASS 11.0 | 27-46-01-01 |
| ECLASS 12.0 | 27-46-01-01 | ECLASS 13.0 | 27-46-01-01 |

Important note

IPC conformity Conformity: The products are developed, manufactured and delivered according international recognized standards and norms and comply with the assured properties in the data sheet resp. fulfill decorative properties in accordance with IPC-A-610 "Class 2". Further claims on the products can be evaluated on request.

Notes

- Additional push button colours on request
- Operating force of slider max. 40 N
- Rated current related to rated cross-section & min. No. of poles.
- Wire end ferrule with plastic collar to DIN 46228/4
- Wire end ferrule without plastic collar to DIN 46228/1
- P on drawing = pitch
- Rated data refer only to the component itself. Clearance and creepage distances to other components are to be designed in accordance with the relevant application standards.
- Crimping shape "A" for wire end ferrules with PZ 6/5 crimping tool recommended.
- Long term storage of the product with average temperature of 50 °C and maximum humidity 70%, 36 months

Approvals

Approvals



| | |
|-------------------------|------------|
| ROHS | Conform |
| UL File Number Search | UL Website |
| Certificate No. (cURus) | E60693 |

LSF-SMD 3.50/12/135 SN BK RL

Weidmüller Interface GmbH & Co. KG
Klingenbergstraße 26
D-32758 Detmold
Germany

www.weidmueller.com

Technical data

Downloads

| | |
|---|---|
| Approval/Certificate/Document of Conformity | Declaration of the Manufacturer |
| Engineering Data | CAD data – STEP |
| Product Change Notification | Changeover to ESD bags for “Tape on Reel” products Umstellung auf ESD-Beutel bei „Tape on Reel“ Produkten |
| Catalogues | Catalogues in PDF-format |
| Brochures | FL DRIVES EN PI OMNIMATE LSF SMD EN FL ANALO.SIGN.CONV. EN MB DEVICE MANUF. EN FL DRIVES DE FL BUILDING SAFETY EN FL APPL LED LIGHTING EN FLIndustr.CONTROLS EN FL MACHINE SAFETY EN FL HEATING ELECTR EN FL APPL INVERTER EN FL_BASE_STATION EN FL ELEVATOR EN FL POWER SUPPLY EN FL 72H SAMPLE SER EN PO OMNIMATE EN |
| White paper surface mount technology | Download Whitepaper |

LSF-SMD 3.50/12/135 SN BK RL

Weidmüller Interface GmbH & Co. KG
 Klingenbergstraße 26
 D-32758 Detmold
 Germany

www.weidmueller.com

Drawings

Product image

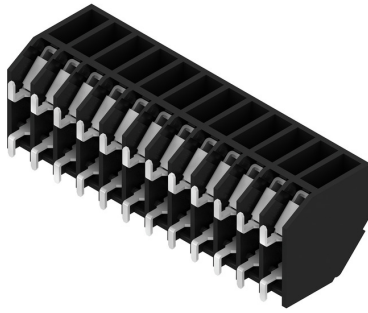

Dimensional drawing

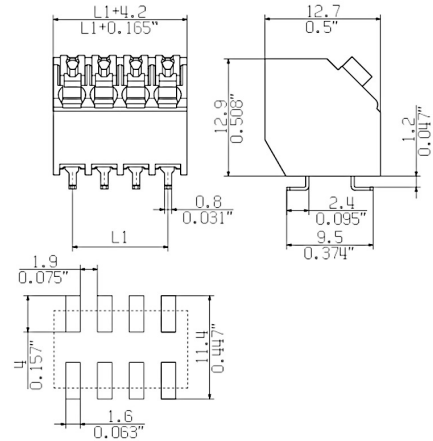

Graph

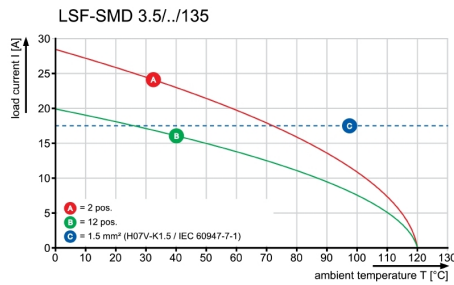

Product benefits

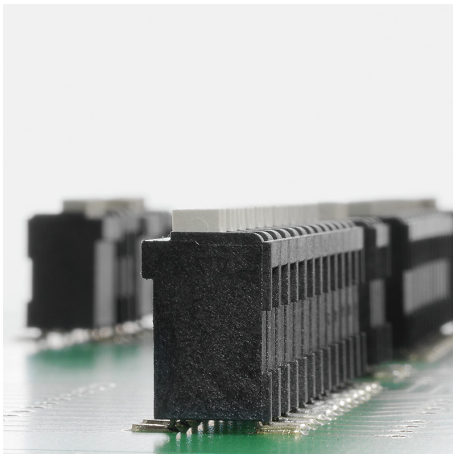

Stable solder connection

Product benefits

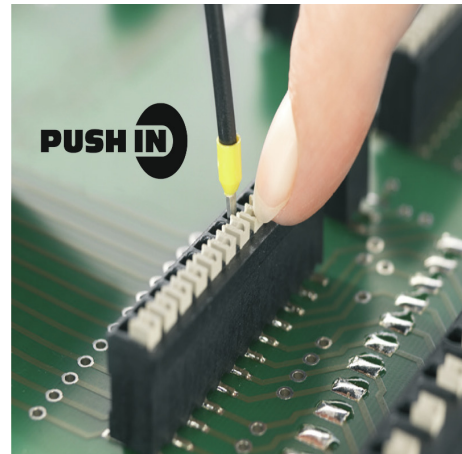

PUSH IN wire connection

LSF-SMD 3.50/12/135 SN BK RL

Weidmüller Interface GmbH & Co. KG
 Klingenbergstraße 26
 D-32758 Detmold
 Germany

www.weidmueller.com

Drawings

Product benefits



Packaged in tape-on-reel

Dimensional drawing

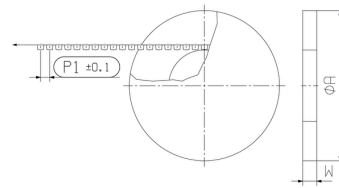

Dimensional drawing

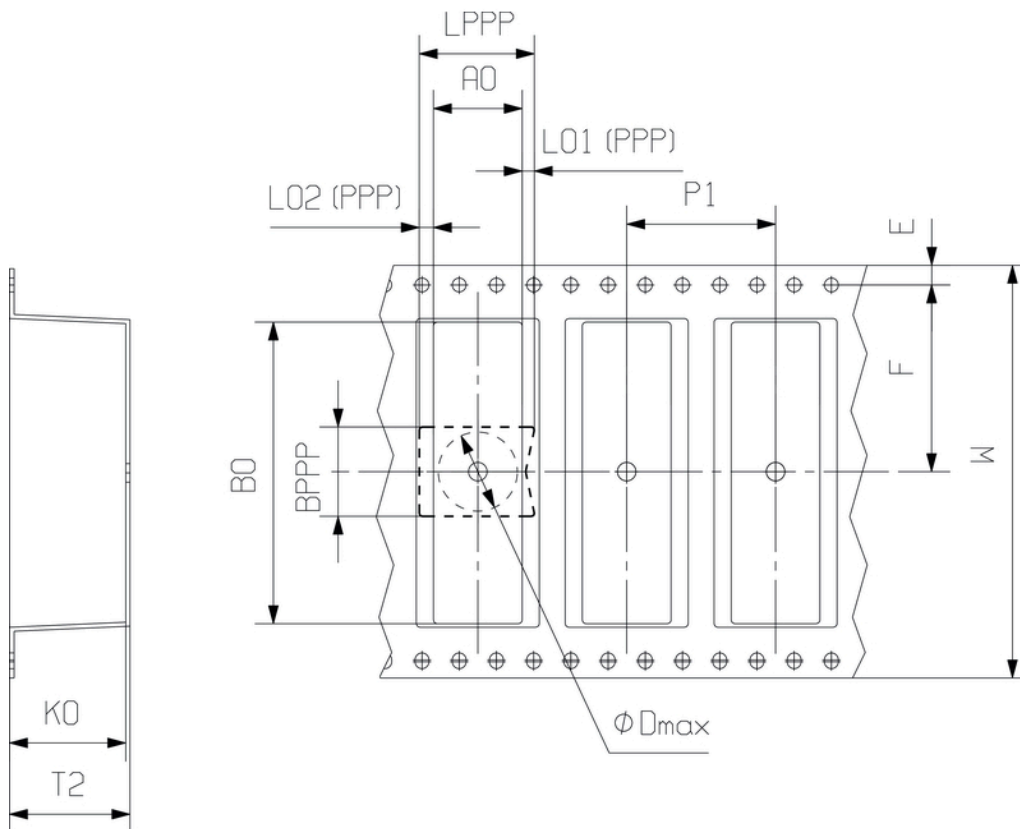

DIRECTION OF UNREELING →

MASSE OHNE TOLERANZ SIND KEINE PRUEFMASSE
DIMS. WITHOUT TOLERANCE ARE NOT CONTROL DIMS.

DIE DEUTSCHE VERSION IST VERBINDLICH
THE GERMAN VERSION IS BINDING

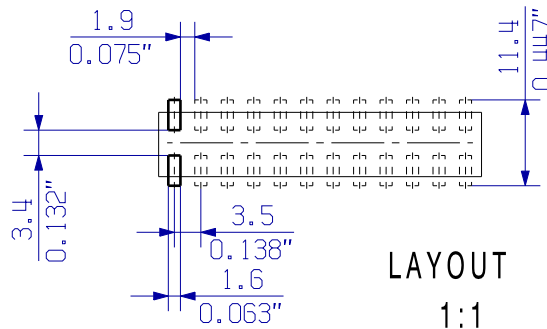
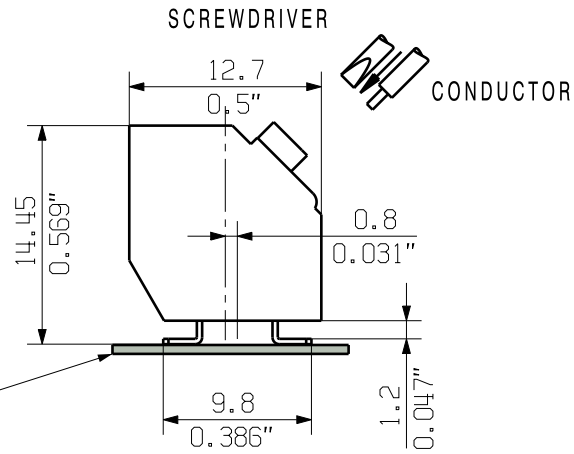
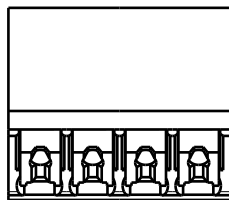
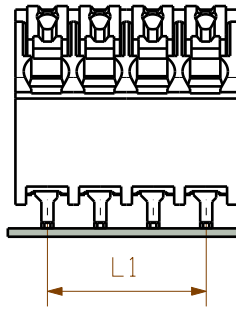
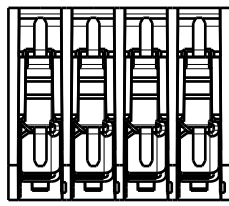

For the mounting on PCBs, it should be noted that the rated data relates only to the PCB components alone.

The necessary creepage and clearance paths must be observed in the relevant equipment standards in accordance with IEC 664 / VDE 0110.

The current-carrying capacity and pitch tolerance is to be determined according to DIN IEC 326 part 3.

Weidmüller PCB components are rated in accordance with the DIN EN 61984 standard, and are valid for its field of application. If the components are used in accordance with the intended purpose, the components will meet all requirements with respect to the occurring of electrical, mechanical, thermic and corrosive stress.

SHOWN: LSF-SMD 3.50/04/135...

| | | |
|----|---------|-----------|
| 12 | 38,5 | 1,516 |
| 11 | 35,0 | 1,378 |
| 10 | 31,5 | 1,240 |
| 9 | 28,0 | 1,102 |
| 8 | 24,5 | 0,965 |
| 7 | 21,0 | 0,827 |
| 6 | 17,5 | 0,689 |
| 5 | 14,0 | 0,551 |
| 4 | 10,5 | 0,413 |
| 3 | 7,0 | 0,276 |
| 2 | 3,5 | 0,138 |
| n | L1 [mm] | L1 [Inch] |

| | | | | | |
|-----------------------------|-------------------------------|-------------------------------|----------------|----------------------------|--|
| | 86128/5 25.01.16 KRUG_M 01 | | CAT.NO.: . . . | | |
| | DIN ISO 2768-m | | | | |
| MODIFICATION | | DRAWING NO. C 57457 04 | | ISSUE NO. | |
| DATE | | SHEET 01 OF 04 SHEETS | | LSF-SMD 3.50/./135 | |
| NAME | | LEITERPLATTENKLEMME | | PCB TERMINAL | |
| DRAWN 03.06.2015 KRUG_M | | SCALE: 2:1 | | PRODUCT FILE: LSF-SMD 3.50 | |
| RESPONSIBLE | | SUPERSEDES: . | | 7358 | |
| CHECKED 02.02.2016 HELIS_MA | | APPROVED | | LANG_T | |

WEITERGABE SOWIE Vervielfaeltigung dieses Dokuments, Verwertung und Mitteilung seines Inhalts sind verboten, soweit nicht Ausdruecklich gestattet.
 ZUWIDERHANDLUNGEN VERPFLICHTEN ZU SCHADENERSATZ. ALLE RECHTE FUER DEN FALL DER PATENT-, GEBRAUCHSMUSTER- ODER GESCHMACKSMUSTEREINTRAGUNG VORBEHALTEN.
 THE REPRODUCTION, DISTRIBUTION AND UTILIZATION OF THIS DOCUMENT AS WELL AS THE COMMUNICATION OF ITS CONTENTS TO OTHERS WITHOUT EXPLICIT AUTHORIZATION IS PROHIBITED.
 OFFENDERS WILL BE HELD LIABLE FOR THE PAYMENT OF DAMAGES. WEIDMUELLER EXCLUSIVELY RESERVES THE RIGHT TO FILE FOR PATENTS, UTILITY MODELS OR DESIGNS.
 © WEIDMUELLER INTERFACE GmbH & Co.KG

Recommended reflow soldering profile

Weidmüller Interface GmbH & Co. KG
 Klingenbergstraße 16
 D-32758 Detmold
 Germany
 Fon: +49 5231 14-0
 Fax: +49 5231 14-292083
 www.weidmueller.com



Reflow soldering profile

The perfect soldering profile for SMT Surface Mount Technology is one the most exiting question in SMT production. But there are more than one correct answer: The diagram of temperature-on-time is related to processing features of solder paste and to maximum load of components.

We have to consider the following parameters:

- Time for pre heating
- Maximum temperature
- Time above melting point
- Time for cooling
- Maximum heating rate
- Maximum cooling rate

We recommend a typical solder profile with associated process limits. With preheating components and board are prepared smoothly for the solder phase. Heating rate is typically $\leq +3\text{K/s}$. In parallel the solder paste is ‚activated‘. The time above melting point of 217°C the paste gets liquid and components and boards begin to connect. The maximum temperature of 245°C to 254°C should stay between 10 and 40 seconds. In the cooling phase at $\geq -6\text{K/s}$ solder is cured. Board and components cool down while avoiding cold cracks.