

Data sheet | Item number: 286-336/001-000

Relay module; Nominal input voltage: 24 VDC; 2 break and 2 make contacts;
Red status indicator; Module width: 25 mm; gray

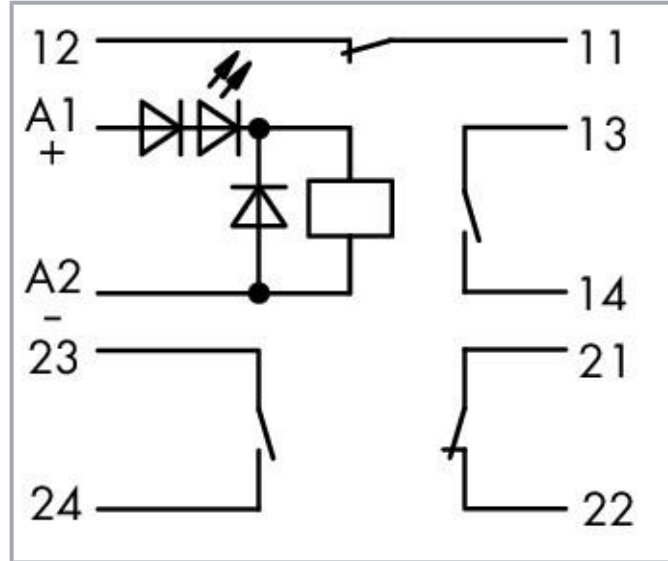

www.wago.com/286-336/001-000

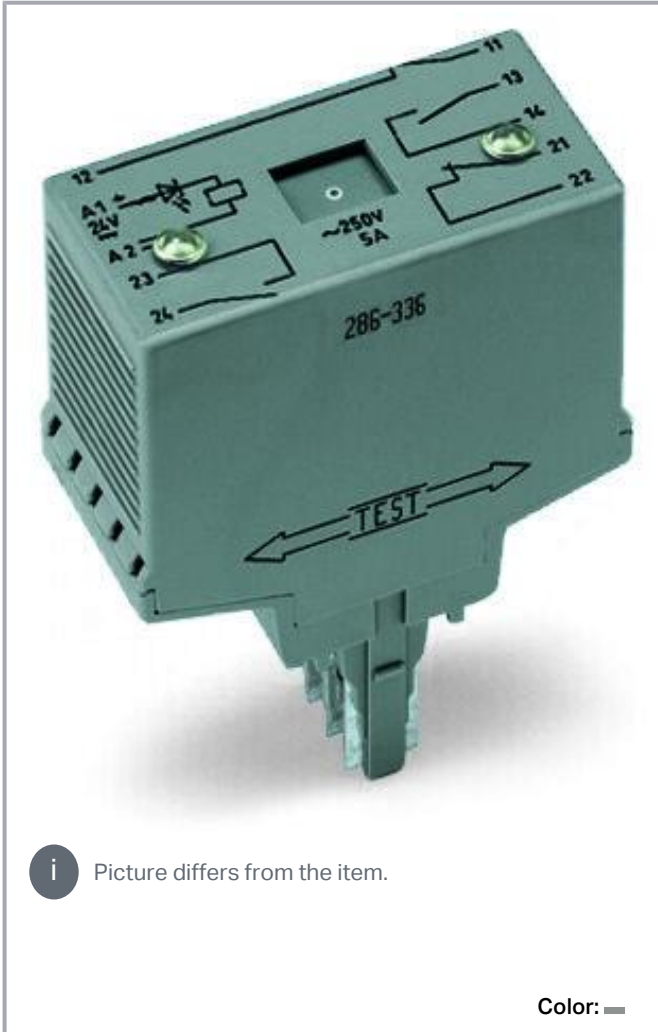

Subject to changes. Please also observe the further product documentation!

WAGO GmbH & Co. KG
Hansastr. 27
32423 Minden
Phone: +49571 887-0 | Fax: +49571 887-169
Email: info.de@wago.com | Web: www.wago.com

Do you have any questions about our products?
We are always happy to take your call at +49 (571) 887-44222.

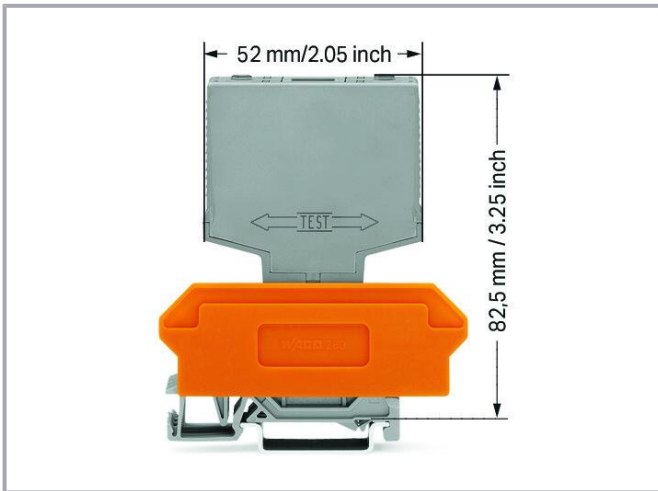

Data

Technical data

Control circuit

Nominal input voltage U_N	DC 24 V
Input voltage range	-30 ... +25 %
Nominal input current at U_N	9 mA

Load circuit

Number of break/switch-off contacts	2
Number of make/switch-on contacts	2
Contact material (relay)	AgNi + Au
Limiting continuous current	5 A
Switching voltage (max.)	AC 250 V
Pull-in time (typ.)	8 ms
Drop-out time (typ.)	5 ms
Bounce time (typ.)	1 ms

Safety and protection

Rated voltage	250 V
Rated surge voltage	2.5 kV
Pollution degree	2
Dielectric strength (control/load circuit) (AC, 1 min)	1.5 kVrms

Subject to changes. Please also observe the further product documentation!

WAGO GmbH & Co. KG
 Hansastr. 27
 32423 Minden
 Phone: +49571 887-0 | Fax: +49571 887-169
 Email: info.de@wago.com | Web: www.wago.com

Do you have any questions about our products?
 We are always happy to take your call at +49 (571) 887-44222.



Protection type	IP20
-----------------	------

Physical data

Width	25 mm / 0.984 inches
Height from upper-edge of DIN-rail	82.5 mm / 3.248 inches
Depth	52 mm / 2.047 inches

Mechanical data

Mounting type	Pluggable module for receptacle terminal blocks
---------------	---

Material data

Color	gray
Fire load	15.112 MJ
Weight	41 g

Environmental requirements

Ambient temperature (operation at U_N)	-25 ... +70 °C
Ambient temperature (storage)	-25 ... +70 °C
Processing temperature	-25 ... +50 °C
Relative humidity	5 ... 85 % (no condensation permissible)
Operating altitude (max.)	2000 m

Standards and specifications

Standards/specifications	EN 60664-1
--------------------------	------------

Commercial data

Product Group	6 (INTERFACE ELECTRONIC)
eCl@ss 10.0	27-37-16-01
eCl@ss 9.0	27-37-16-01
ETIM 8.0	EC001437
ETIM 7.0	EC001437
ECCN	NO DATA
PU (SPU)	10 (1) pcs
Packaging type	box
Country of origin	DE

Subject to changes. Please also observe the further product documentation!



GTIN	4055143104746
Customs tariff number	85364900990

Environmental Product Compliance

CAS-No.	7439-92-1 79-94-7
REACH Candidate List Substance	2,2',6,6'-tetrabromo-4,4'-isopropylidenediphenol Lead
RoHS Compliance Status	Compliant,With Exemption
RoHS Exemption	6(c) 7(a) 7(c)-I
SCIP notification number (Austria)	0a793143-49f9-4230-a7c2-fc470a395514
SCIP notification number (Belgium)	453f8920-e96d-40ba-9383-2af524fc623f
SCIP notification number (Bulgaria)	880f53e2-0ae2-4667-baa1-954f12b89cd1
SCIP notification number (Czech Republic)	9c21aa3d-2696-4dd2-9bc6-a4b95876e79a
SCIP notification number (Denmark)	13a39cb9-98ec-458a-bc7c-9e8617817518
SCIP notification number (Finland)	3aa3f4d2-160d-482f-8b4b-6922d0195b73
SCIP notification number (France)	624a2c7e-e10f-4fc0-bee8-915e3274a034
SCIP notification number (Germany)	85020e9d-7328-4dd4-a608-8ec2a6697673
SCIP notification number (Hungary)	a409d1b6-f6d2-44ce-af6a-25c19ec5b265
SCIP notification number (Italy)	1d2acd3b-2431-43d7-b060-66284d6ae26b
SCIP notification number (Netherlands)	c7f767b4-b6af-4f42-8303-f5dab8dff9d1
SCIP notification number (Poland)	a471ada6-9072-48b5-8684-283220f57979
SCIP notification number (Romania)	fbe0b43a-0dc4-4263-be78-bdec9d72cf89
SCIP notification number (Sweden)	4bfb380a-0379-4ff8-a7c1-ef2b4f12ef13

Approvals / Certificates**General approvals**

Logo	Approval	Additional Approval Text	Certificate name
	EAC Brjansker Zertifizierungsstelle	TP TC 004/2011	EAC RU C- DE.AM02. B.00122 /19

Optional accessories**Marking accessories**

Subject to changes. Please also observe the further product documentation!

WAGO GmbH & Co. KG
Hansastr. 27
32423 Minden
Phone: +49571 887-0 | Fax: +49571 887-169
Email: info.de@wago.com | Web: www.wago.com

Do you have any questions about our products?
We are always happy to take your call at +49 (571) 887-44222.

Marker



Item no.: 209-701
WSB marking card; as card; not stretchable; plain; snap-on type; white

www.wago.com/209-701

Terminal blocks

Terminal block for pluggable modules



Item no.: 280-629
Terminal block for pluggable modules; 10-pole; with 4-conductor terminal blocks; with orange separator; for DIN-rail 35 x 15 and 35 x 7.5; 2.5 mm²; CAGE CLAMP®; 2,50 mm²; gray

www.wago.com/280-629



Item no.: 280-639
Terminal block for pluggable modules; 10-pole; with 2-conductor terminal blocks; with orange separator; for DIN-rail 35 x 15 and 35 x 7.5; 2.5 mm²; CAGE CLAMP®; 2,50 mm²; gray

www.wago.com/280-639



Item no.: 280-765
Terminal block for pluggable modules; 10-pole; with 4-conductor terminal blocks; with marker carrier; with orange separator; for DIN-rail 35 x 15 and 35 x 7.5; 2.5 mm²; CAGE CLAMP®; 2,50 mm²; gray

www.wago.com/280-765

Downloads

Documentation

Bid Text

286-336/001-000 X81 - Datei	2019 Feb 19	xml 3.9 kB	Download
286-336/001-000 doc - Datei	2015 Mar 27	doc 27.6 kB	Download

Instruction Leaflet

		pdf 1.3 MB	Download
--	--	---------------	----------

Additional Information

Disposal and Recycling Electrical and electronic equipment, Batteries, Packaging	V 1.1.0 2022 Aug 18	pdf 2.2 MB	Download
---	------------------------	---------------	----------

CAD/CAE-Data

CAE data

WSCAD Universe 286-336/001-000		URL	Download
WSCAD Universe 286-336/001-000		URL	Download

Subject to changes. Please also observe the further product documentation!

Environmental Product Compliance

Compliance Search

Environmental Product Compliance 286-336/001-000

URL

Download

Relay module; Nominal input voltage: 24 VDC; 2 break and 2 make contacts; Red status indicator; Module width: 25 mm; gray

Installation Notes

Installation

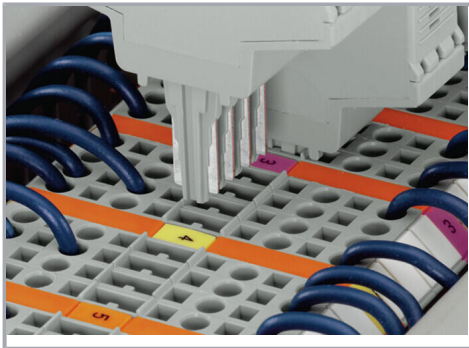

Coding ensures correct polarity.

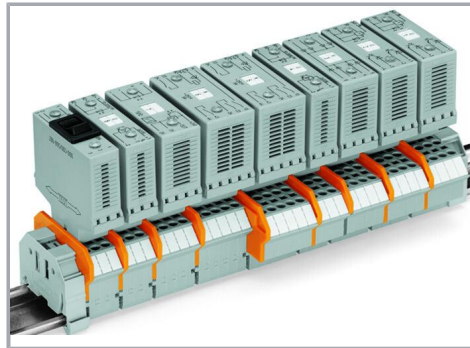

Pluggable electronic modules on 2- or 4-conductor carrier terminal blocks

Marking

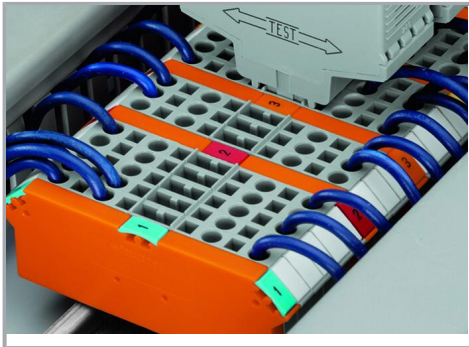

Marking via WMB Multi Marking System.

Testing

Subject to changes. Please also observe the further product documentation!



Function testing via touch-proof test slots

Subject to changes. Please also observe the further product documentation!

WAGO GmbH & Co. KG
Hansastr. 27
32423 Minden
Phone: +49571 887-0 | Fax: +49571 887-169
Email: info.de@wago.com | Web: www.wago.com

Do you have any questions about our products?
We are always happy to take your call at +49 (571) 887-44222.