

WCLA2520V1

Automotive grade wire wound chip inductor

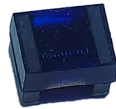

Product features

- AEC-Q200 qualified
- 1008 (2520 metric) package
- Ferrite core wire wound construction
- Inductance range from 0.22 μ H to 47 μ H
- Moisture sensitivity level (MSL): 1

Applications

- ADAS
- Infotainment
- Wireless communications
- Wifi, bluetooth, satellite
- Antenna tuning
- On board computer

Environmental data

- Operating temperature range: -55 °C to +125 °C (ambient plus self-temperature rise)



Product specifications

Part number ²	OCL Tolerance (%)	OCL (µH)	OCL Test frequency (MHz)	Q minimum	Q Test frequency (MHz)	DCR (Ω) @ +25 °C maximum	Test voltage ¹ (mV)	SRF (MHz) minimum	I Rated (mA)
WCLA2520V1-R22-R	±10%	0.22	25.2	30	25.2	0.5	500	450	1100
WCLA2520V1-1R0-R	±10%	1	7.96	12	7.96	0.13	500	345	1000
WCLA2520V1-1R5-R	±10%	1.5	7.96	12	7.96	0.17	500	100	850
WCLA2520V1-2R2-R	±10%	2.2	7.96	12	7.96	0.21	500	78	775
WCLA2520V1-3R3-R	±10%	3.3	7.96	12	7.96	0.26	500	48	715
WCLA2520V1-4R7-R	±10%	4.7	7.96	12	7.96	0.52	500	46	505
WCLA2520V1-6R8-R	±10%	6.8	7.96	12	7.96	0.72	500	33	432
WCLA2520V1-8R2-R	±10%	8.2	2.52	12	2.52	0.76	500	30	410
WCLA2520V1-100-R	±10%	10	2.52	12	2.52	0.86	500	28	392
WCLA2520V1-150-R	±10%	15	2.52	12	2.52	1.09	500	21	342
WCLA2520V1-220-R	±10%	22	2.52	12	2.52	1.96	500	18	260
WCLA2520V1-330-R	±10%	33	2.52	12	2.52	2.47	500	15	236
WCLA2520V1-470-R	±10%	47	2.52	20	2.52	8.34	500	18	100

1. Test voltage is for open circuit inductance (OCL) and Q at +25 °C

2. Part Number Definition: WCLA2520V1-xxx-R
WCLA2520V1 = Product code and size
xxx= inductance value in µH, R= decimal point,
If no R is present then last character equals number of zeros
-R suffix = RoHS compliant

Dimensions (mm)

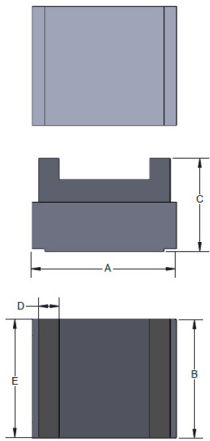

Recommended pad layout

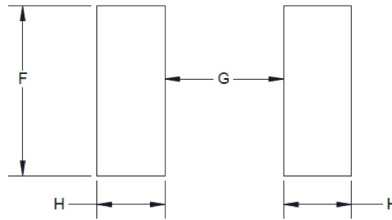

Schematic

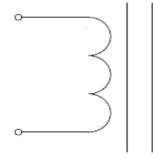

Part Number	A	B	C	D	E	F	G	H
WCLA2520V1-xxx-R	2.90 max	2.50 max	2.10 max	0.60 ±0.10	2.50 max	2.54 ref	1.27 ref	1.02 ref

Part marking: No marking
All soldering surfaces to be coplanar within 0.1 millimeters
Tolerances are ±0.1 millimeters unless stated otherwise
Pad layout dimensions are reference only
Traces or vias underneath the inductor is not recommended

Packaging information (mm)

Drawing not to scale

Supplied in tape and reel packaging, 2000 parts per 7" diameter reel (EIA-481 compliant)

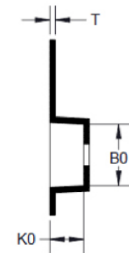
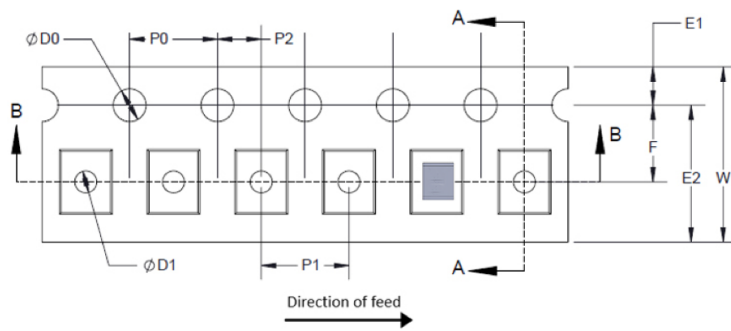

SECTION A-A

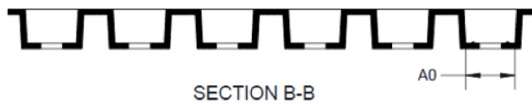
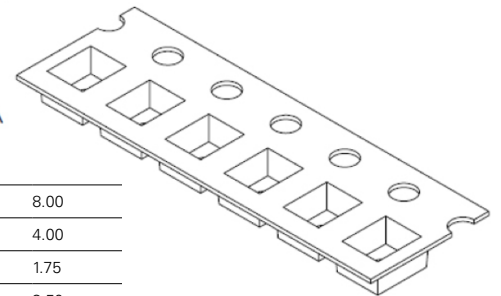

SECTION B-B

W±0.1	8.00
P1±0.1	4.00
E1±0.1	1.75
F±0.05	3.50
P2±0.05	2.00
D0+0.10/-0	1.50
D1±0.10	1.00
B0±0.10	2.61
A0±0.10	2.93
K0±0.10	2.25
P0±0.10	4.00
T±0.05	0.26

Inductance vs frequency

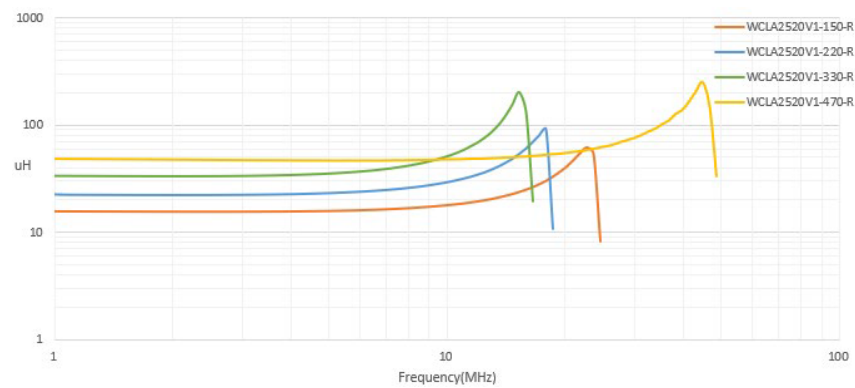
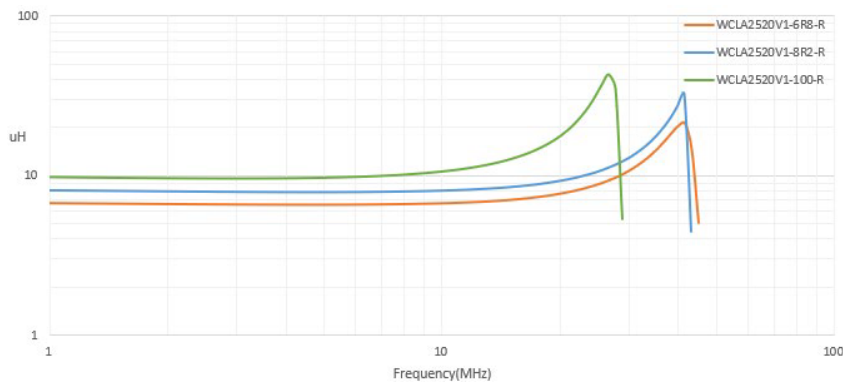
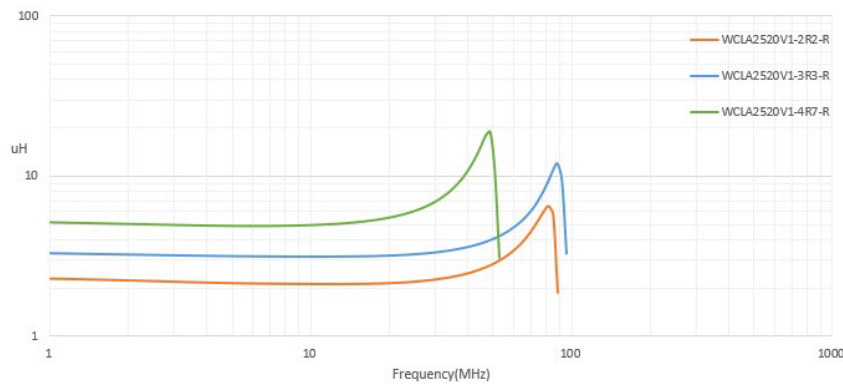
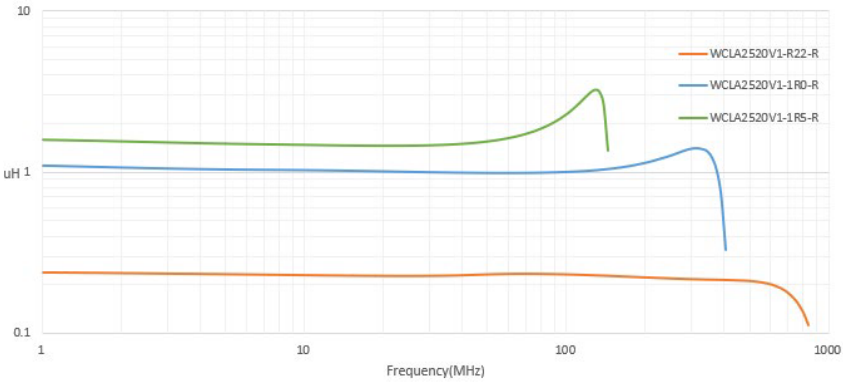

Q vs frequency

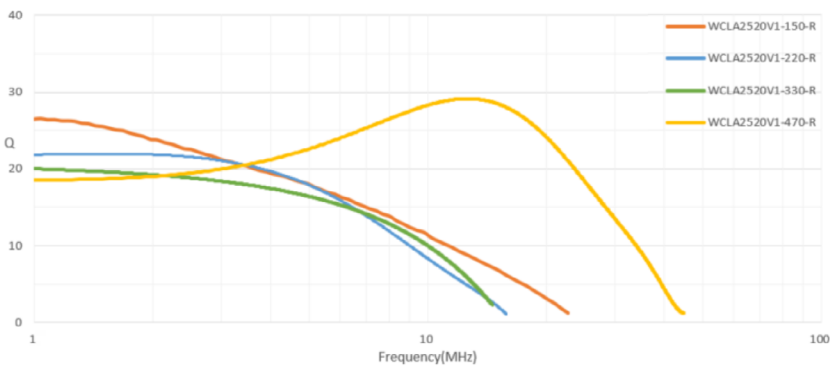
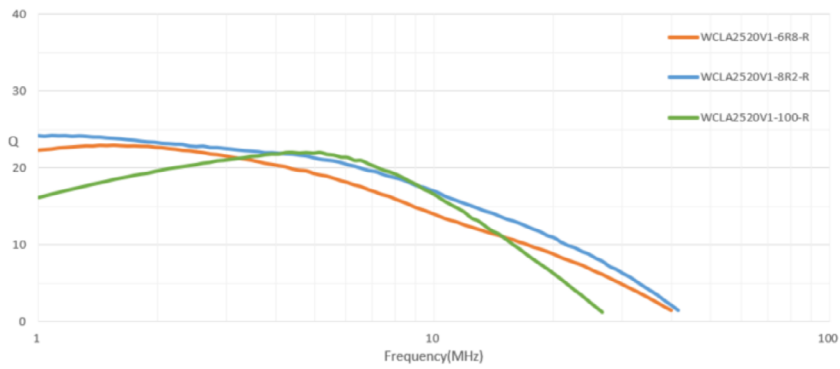
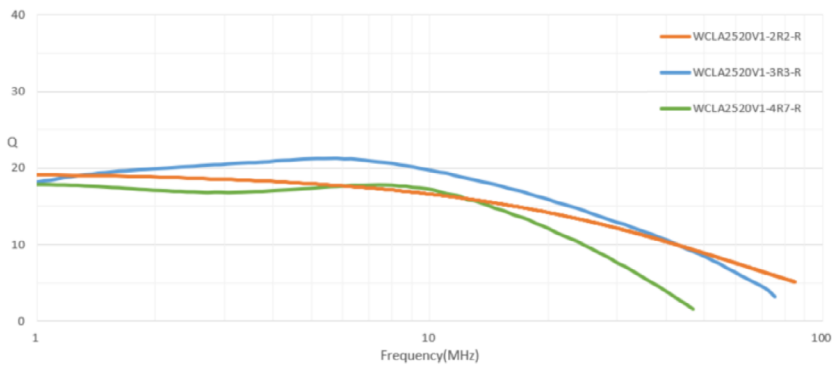
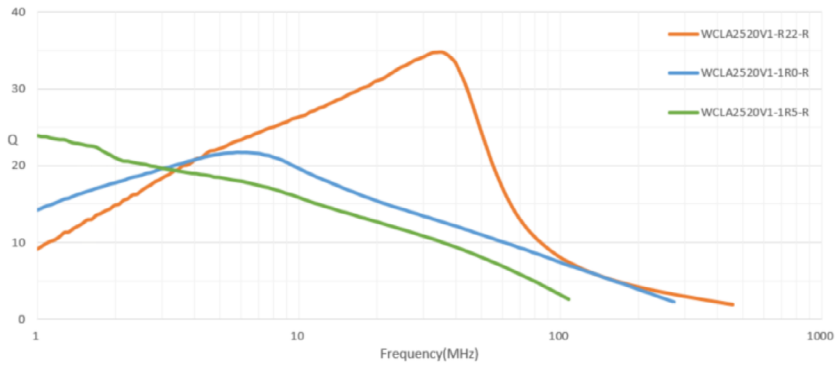

Solder reflow profile

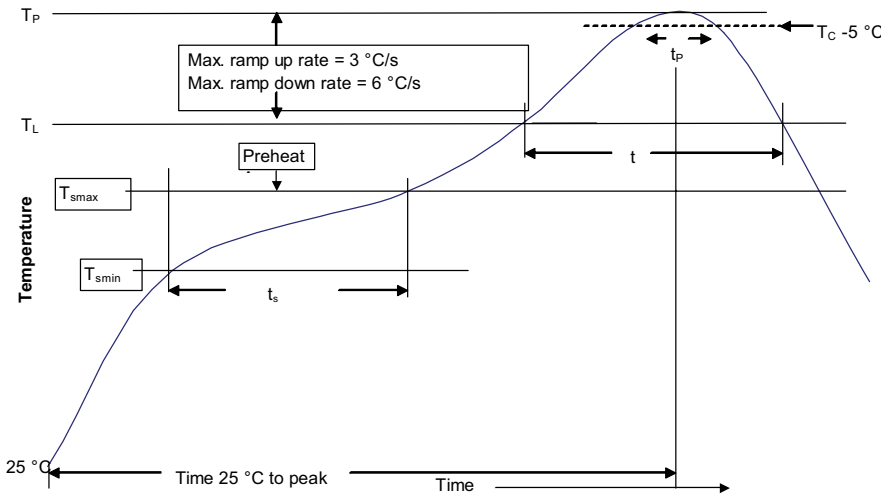

Table 1 - Standard SnPb solder (T_C)

Package thickness	Volume mm ³ <350	Volume mm ³ ≥350
<2.5 mm	235 °C	220 °C
≥2.5 mm	220 °C	220 °C

Table 2 - Lead (Pb) free solder (T_C)

Package thickness	Volume mm ³ <350	Volume mm ³ 350 - 2000	Volume mm ³ >2000
<1.6 mm	260 °C	260 °C	260 °C
1.6 – 2.5 mm	260 °C	250 °C	245 °C
>2.5 mm	250 °C	245 °C	245 °C

Reference J-STD-020

Profile feature	Standard SnPb solder	Lead (Pb) free solder
Preheat and soak	<ul style="list-style-type: none"> Temperature min. (T_{smin}) Temperature max. (T_{smax}) Time (T_{smin} to T_{smax}) (t_s) 	<ul style="list-style-type: none"> 100 °C 150 °C 60-120 seconds
Ramp up rate T_L to T_p	3 °C/ second max.	3 °C/ second max.
Liquidous temperature (T_L) Time (t_L) maintained above T_L	<ul style="list-style-type: none"> 183 °C 60-150 seconds 	<ul style="list-style-type: none"> 217 °C 60-150 seconds
Peak package body temperature (T_p)*	Table 1	Table 2
Time (t_p)* within 5 °C of the specified classification temperature (T_C)	20 seconds*	30 seconds*
Ramp-down rate (T_p to T_L)	6 °C/ second max.	6 °C/ second max.
Time 25 °C to peak temperature	6 minutes max.	8 minutes max.

* Tolerance for peak profile temperature (T_p) is defined as a supplier minimum and a user maximum.

Manual solder

Use a 20 watt soldering iron with tip diameter of 1.0 mm maximum. +350 °C, 4-5 seconds maximum, generally manual, hand soldering is not recommended.

Life Support Policy: Eaton does not authorize the use of any of its products for use in life support devices or systems without the express written approval of an officer of the Company. Life support systems are devices which support or sustain life, and whose failure to perform, when properly used in accordance with instructions for use provided in the labeling, can be reasonably expected to result in significant injury to the user.

Eaton reserves the right, without notice, to change design or construction of any products and to discontinue or limit distribution of any products. Eaton also reserves the right to change or update, without notice, any technical information contained in this bulletin.

Eaton
Electronics Division
1000 Eaton Boulevard
Cleveland, OH 44122
United States
Eaton.com/electronics

© 2022 Eaton
All Rights Reserved
Printed in USA
Publication No. ELX1152 BU-ELX22011
March 2022

Eaton is a registered trademark.
All other trademarks are property of their respective owners.

Follow us on social media to get the latest product and support information.

