

WCL3225

Wire wound chip inductor



Product features

- 1210 (3225 metric) package
- High Q value
- Tight inductance tolerance
- Inductance range from 0.12 μ H to 560 μ H
- Moisture sensitivity level (MSL): 1

Applications

- Industrial connectivity (IoT)
- Computing/gaming consoles
- Smart meters
- Industrial equipment
- Machine-to-machine (M2M)
- Mobile phones
- Wearable devices
- Wireless LAN
- Wireless communications
 - Bluetooth
 - WiFi
 - Antenna
- RF transceiver modules

Environmental data

- Operating temperature range: -40 °C to +85 °C
- Solder reflow temperature:
J-STD-020 (latest revision) compliant



Product specifications

Part number	OCL (uH) ±5%	I Rated (mA) maximum	OCL Test frequency (MHz)	Test voltage (mV)	DCR (Ω) maximum @ +25°C	SRF (MHz) minimum	Q minimum	Q Test frequency (MHz)
WCL3225-R12-R	0.12	450	25.2	500	0.20	850	20	25.2
WCL3225-R27-R	0.27	450	25.2	500	0.20	700	20	25.2
WCL3225-R33-R	0.33	450	25.2	500	0.30	520	20	25.2
WCL3225-R47-R	0.47	450	25.2	500	0.30	480	20	25.2
WCL3225-R82-R	0.82	450	25.2	500	0.30	350	20	25.2
WCL3225-1R0-R	1.0	450	7.96	500	0.30	320	12	7.96
WCL3225-1R2-R	1.2	450	7.96	500	0.30	210	12	7.96
WCL3225-1R5-R	1.5	450	7.96	500	0.40	200	12	7.96
WCL3225-1R8-R	1.8	450	7.96	500	0.50	195	12	7.96
WCL3225-2R2-R	2.2	450	7.96	500	0.60	175	12	7.96
WCL3225-2R7-R	2.7	420	7.96	500	0.70	120	12	7.96
WCL3225-3R3-R	3.3	380	7.96	500	1.10	80	12	7.96
WCL3225-3R9-R	3.9	360	7.96	500	1.20	75	12	7.96
WCL3225-4R7-R	4.7	350	7.96	500	1.30	60	12	7.96
WCL3225-5R6-R	5.6	320	7.96	500	2.00	50	12	7.96
WCL3225-6R8-R	6.8	310	7.96	500	1.50	35	12	7.96
WCL3225-8R2-R	8.2	305	7.96	500	1.60	35	12	7.96
WCL3225-100-R	10	300	2.52	500	1.00	30	10	2.52
WCL3225-120-R	12	265	2.52	500	1.20	25	10	2.52
WCL3225-150-R	15	225	2.52	500	2.00	22	10	2.52
WCL3225-180-R	18	210	2.52	500	2.10	22	10	2.52
WCL3225-220-R	22	200	2.52	500	2.40	20	10	2.52
WCL3225-270-R	27	180	2.52	500	2.70	18	10	2.52
WCL3225-330-R	33	160	2.52	500	2.90	15	10	2.52
WCL3225-390-R	39	150	2.52	500	4.70	16	10	2.52
WCL3225-470-R	47	140	2.52	500	5.20	10	10	2.52
WCL3225-560-R	56	125	2.52	500	5.60	8.0	10	2.52
WCL3225-680-R	68	110	2.52	500	4.70	5.0	10	2.52
WCL3225-820-R	82	100	2.52	500	5.60	5.0	10	2.52
WCL3225-101-R	100	95	0.796	500	6.80	5.0	8	0.796
WCL3225-121-R	120	85	0.796	500	7.90	4.0	8	0.796
WCL3225-151-R	150	80	0.796	500	9.00	4.0	8	0.796
WCL3225-181-R	180	70	0.796	500	14.5	3.0	8	0.796
WCL3225-221-R	220	65	0.796	500	16.5	2.6	8	0.796
WCL3225-271-R	270	60	0.796	500	18.0	2.5	8	0.796
WCL3225-331-R	330	55	0.796	500	19.0	2.3	8	0.796
WCL3225-391-R	390	45	0.796	500	21.5	2.2	8	0.796
WCL3225-471-R	470	40	0.796	500	22.5	2.0	8	0.796
WCL3225-561-R	560	30	0.796	500	28.0	1.5	8	0.796

1. Test frequency and voltage at +25 °C. Test voltage is for both OCL and Q.
2. Resistance to soldering heat: +260 ±5 °C for 10 ± 1 second
3. At low temperature resistance (-40 ±2°C) the inductance change is within ±5% and the Q within ±10%
4. At high temperature resistance (+85 ±5°C) the inductance change is within ±5% and the Q within ±10%
5. At high temperature load (+85 ±2°C) the inductance change is within ±5% and the Q within ±10%

6. Insulation Resistance: ≥ 500 MΩ with an input voltage of 100 V ±15 Vdc
- 7 Temperature Characteristics: From -40 °C to +85 °C the inductance is within ±5%
8. Rated I: When rated I is applied to the product, self-temperature rise will be 20 °C or less.
9. Part Number Definition: WCL2520-xxx-R
WCL2520 = Product code and size
xxx= inductance value in uH, R= decimal point,
If no R is present then last character equals number of zeros
-R suffix = RoHS compliant

Dimensions (mm)

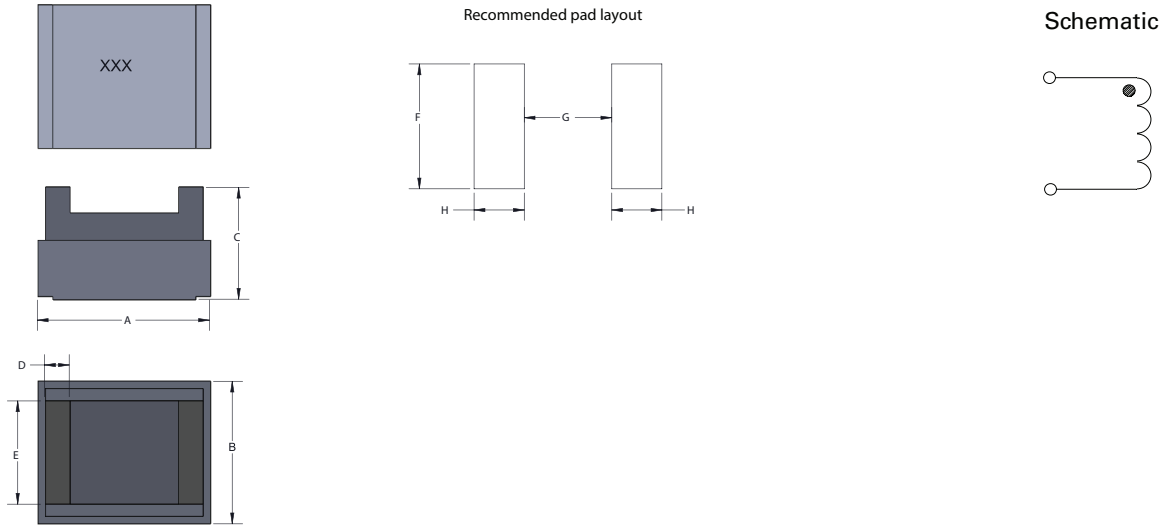

Part Number	A	B	C	D	E	F	G	H
WCL3225-xxx-R	3.5 max	2.9 max	2.25 max	0.50 ref	2.1 ref	2.54	1.78	1.02

Part marking: xxx= Inductance value in uH, R=decimal point. If no R is present then last character equals number of zeros
 All soldering surfaces to be coplanar within 0.1 millimeters
 Tolerances are ±0.2 millimeters unless stated otherwise
 Pad layout tolerances are ±0.1 millimeters unless stated otherwise
 Do not route traces or vias underneath the inductor

Packaging information (mm)

Drawing not to scale
 Supplied in tape and reel packaging, 2000 parts per 7" diameter reel

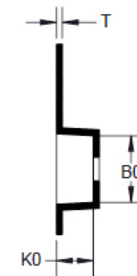
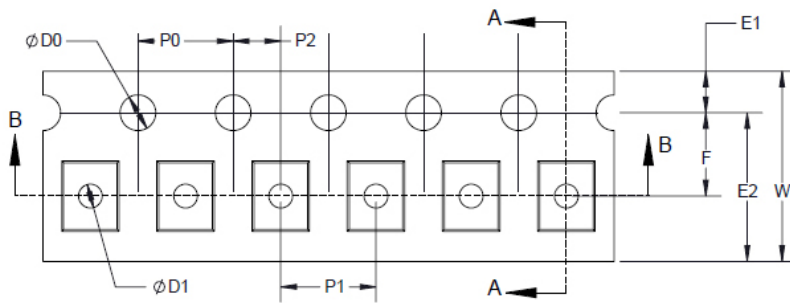

SECTION A-A

W ±0.30	8.00
F ±0.05	3.50
E1 ±0.10	1.75
E2 Min	6.25
P0 ±0.10	4.00
P1 ±0.10	4.00
P2 ±0.05	2.00
D0 +0.10/-0	1.50
D1 +0.10/-0	0.65
A0	2.96 ±0.05
B0	3.60 ±0.10
K0	2.4 ±0.10
T Max	0.23

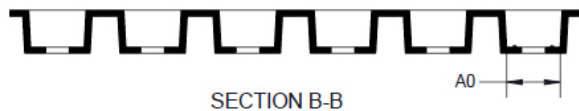

SECTION B-B

Inductance vs frequency

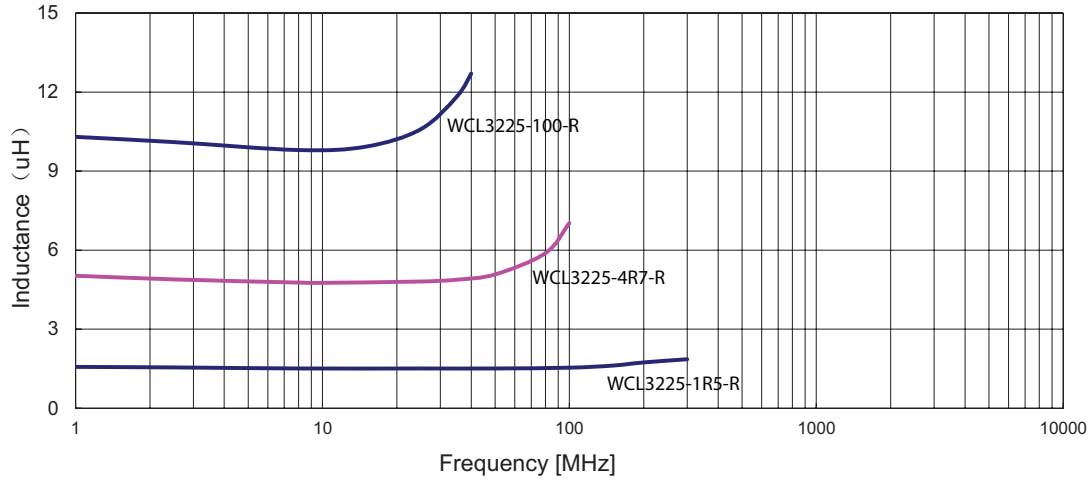

Q vs frequency

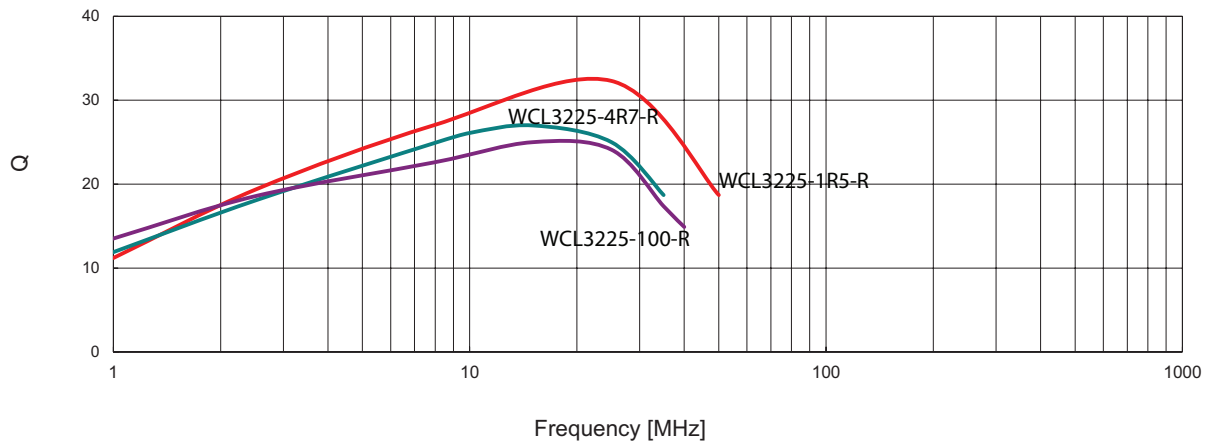

Solder reflow profile

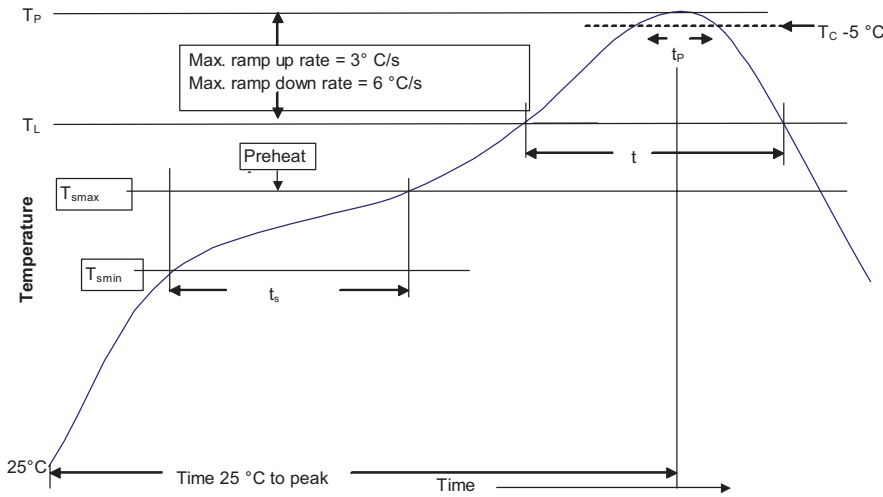

Table 1 - Standard SnPb solder (T_C)

Package Thickness	Volume mm ³ <350	Volume mm ³ ≥350
<2.5 mm)	235 °C	220 °C
≥2.5 mm	220 °C	220 °C

Table 2 - Lead (Pb) free solder (T_C)

Package thickness	Volume mm ³ <350	Volume mm ³ 350 - 2000	Volume mm ³ >2000
<1.6 mm	260 °C	260 °C	260 °C
1.6 – 2.5 mm	260 °C	250 °C	245 °C
>2.5 mm	250 °C	245 °C	245 °C

Reference J-STD-020

Profile feature	Standard SnPb solder	Lead (Pb) free solder
Preheat and soak		
• Temperature min. (T_{smin})	100 °C	150 °C
• Temperature max. (T_{smax})	150 °C	200 °C
• Time (T_{smin} to T_{smax}) (t_s)	60-120 seconds	60-120 seconds
Average ramp up rate T_{smax} to T_p	3 °C/ second max.	3 °C/ second max.
Liquidous temperature (T_L)	183 °C	217 °C
Time at liquidous (t_L)	60-150 seconds	60-150 seconds
Peak package body temperature (T_p)*	Table 1	Table 2
Time (t_p)** within 5 °C of the specified classification temperature (T_C)	10 seconds**	10 seconds**
Average ramp-down rate (T_p to T_{smax})	6 °C/ second max.	6 °C/ second max.
Time 25 °C to peak temperature	6 minutes max.	8 minutes max.

* Tolerance for peak profile temperature (T_p) is defined as a supplier minimum and a user maximum.
 ** Tolerance for time at peak profile temperature (t_p) is defined as a supplier minimum and a user maximum.

Life Support Policy: Eaton does not authorize the use of any of its products for use in life support devices or systems without the express written approval of an officer of the Company. Life support systems are devices which support or sustain life, and whose failure to perform, when properly used in accordance with instructions for use provided in the labeling, can be reasonably expected to result in significant injury to the user.

Eaton reserves the right, without notice, to change design or construction of any products and to discontinue or limit distribution of any products. Eaton also reserves the right to change or update, without notice, any technical information contained in this bulletin.

Eaton
Electronics Division
 1000 Eaton Boulevard
 Cleveland, OH 44122
 United States
www.eaton.com/electronics

© 2019 Eaton
 All Rights Reserved
 Printed in USA
 Publication No. 10931 BU-MC19063
 July 2019

Eaton is a registered trademark.
 All other trademarks are property of their respective owners.

Follow us on social media to get the latest product and support information.

