

REV.	Q'TY	ECN. NO.	APR.	DATE

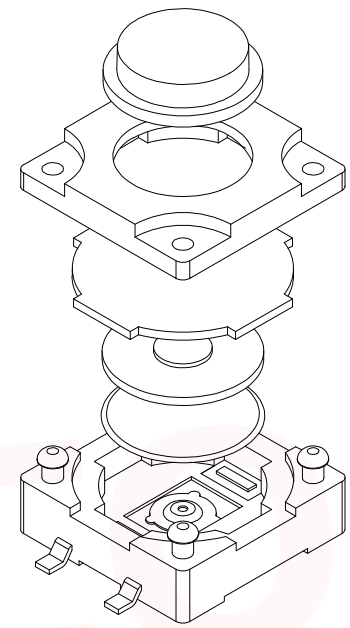

The Main Thchnology Performance

Rate voltage.current	50mA DC12V
Contact resistance	$\leq 100m\Omega$
Operating force	$\pm 30gf$
Travel	$0.30\pm 0.10mm$
Insulated resistance	$> 100M\Omega$
Dielectric strength	$> 250VAC/1min$
IP rating	IP67

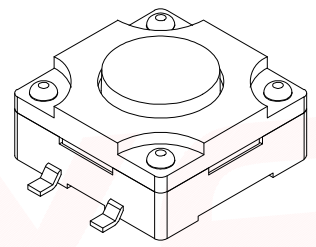
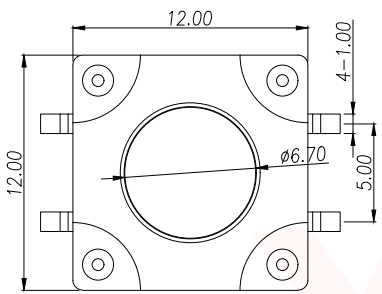
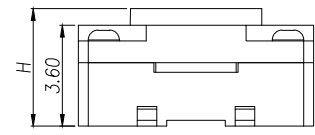
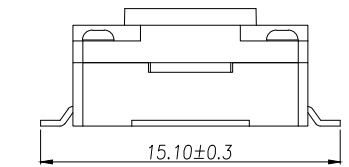
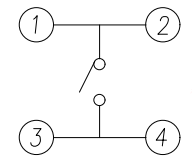

CIRCUIT DIAGRAM

ITEM	DESCRIPTION	MATERIAL	QTY	FINSH/COLOR
G	按钮	PPA	1	黑色
F	盖板	PPA	1	黑色
E	防尘胶	硅胶	1	黑色
D	内嵌	PPA	1	黑色
C	弹片	磷铜/不锈钢	1	镀镍
B	本件	PPA	1	黑色
A	卡件	黄铜	1	镀镍

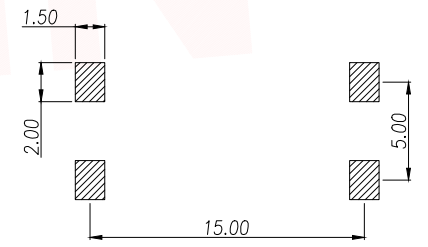

PCB.WELDING DRAWING

T S O 1 8 A - T B Y 1

力度: F: 250G E: 180G  
 高度: H4.3 H4.5  
 .....

H	H	H
4.3	6.5	9.5
4.5	7.0	10.0
4.8	7.5	10.5
5.0	8.0	11.0
5.5	8.5	11.5
6.0	9.0	12.0

DIMENSION IN mm		TOLERANCE UNLESS OTHERWISE SPECIFIED		厦门市辛译精密电子有限公司 Xiamen XinYi Xyeconn Electronics Co.,Ltd	
.X $\pm$ 0.35	X.* $\pm$ 5*	APR.	Alex	TITLE: 12x12 SMD TACT SWITCH	
.XX $\pm$ 0.25	.X* $\pm$ 3*	CHK.	Jack	DWG NO. TS018A-TBY1FHX	
.XXX $\pm$ 0.15	.XX* $\pm$ 1*	DRA.	Can	PROJ.  CUSTOMER DRAWING	
SIZE A4	SCALE 1:1	SHEET 1/1	REV. A		