

CLM2D-GEC/BEC: PLCC4 Green & Blue SMD LEDs

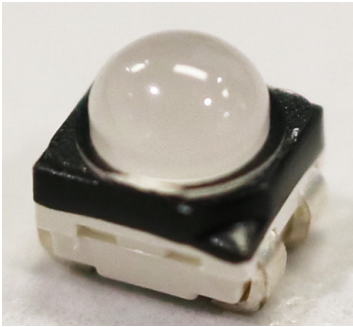

PRODUCT DESCRIPTION

SMD LEDs is packaged in the industry standard package. These LEDs have high reliability performance and are designed to work under a wide range of environmental conditions. This high reliability feature makes them ideally suited to be used in architectural lighting application conditions

Cree LED has been certified in accordance with ISO/IATF16949.

FEATURES

- Size (mm): 3.2 x 2.8
- Color and Typical Dominant Wavelength:
 - Green (520-535nm)
 - Blue (465-475nm)
- Moisture Sensitivity Level: 5a
- Lead - Free
- RoHS Compliant
- Untinted Diffused Lens

APPLICATIONS

- Channel Letter
- Architectural Lighting

ABSOLUTE MAXIMUM RATINGS ($T_A = 25^\circ\text{C}$)

Items	Symbol	Absolute Maximum Rating		Unit
		Green	Blue	
Forward Current	I_F	35		mA
Peak Forward Current ^{Note1}	I_{FP}	100		mA
Reverse Voltage	V_R	5		V
Power Dissipation	P_D	140		mW
Operation Temperature	T_{opr}	-40 ~ +100		$^\circ\text{C}$
Storage Temperature	T_{stg}	-40 ~ +100		$^\circ\text{C}$
Junction Temperature	T_J	110		$^\circ\text{C}$
Junction/Ambient	R_{THJA}	450	320	$^\circ\text{C}/\text{W}$
Junction/Solder Point	R_{THJS}	220	150	$^\circ\text{C}/\text{W}$

Note:

1. Pulse width ≤ 0.1 msec, duty $\leq 1/10$.

TYPICAL ELECTRICAL & OPTICAL CHARACTERISTICS ($T_A = 25^\circ\text{C}$)

Characteristics	Color	Symbol	Condition	Unit	Minimum	Typical	Maximum
Forward Voltage	Green	V_F	$I_F = 20$ mA	V		2.8	4.0
	Blue	V_F	$I_F = 20$ mA	V		2.9	4.0
Reverse Current	Green/Blue	I_R	$V_R = 5$ V	μA			10
Dominant Wavelength	Green	λ_D	$I_F = 20$ mA	nm	520	527.5	535
	Blue	λ_D	$I_F = 20$ mA	nm	465	470	475
Luminous Intensity	Green	I_V	$I_F = 20$ mA	mcd	2800	4000	
	Blue	I_V	$I_F = 20$ mA	mcd	560	900	

- * Continuous reverse voltage can cause LED damage.

INTENSITY BIN LIMIT

Green (20 mA)			Blue (20 mA)		
Bin Code	Min.(mcd)	Max.(mcd)	Bin Code	Min.(mcd)	Max.(mcd)
Ya	2800	3550	Ub	560	710
Yb	3550	4500	Va	710	900
Z0	4500	5600	Vb	900	1120
A0	5600	7100	Wa	1120	1400

* Tolerance of measurement of luminous intensity is $\pm 10\%$

COLOR BIN LIMIT

Green (20 mA)			Blue (20 mA)		
Bin Code	Min.(nm)	Max.(nm)	Bin Code	Min.(nm)	Max.(nm)
G7	520	525	B4	465	470
G23	522.5	527.5	B45	467.5	472.5
G8	525	530	B5	470	475
G45	527.5	532.5			
G9	530	535			

* Tolerance of measurement of dominant wavelength is ± 1 nm.

ORDER CODE TABLE

Color	Kit Number	Luminous Intensity (mcd)		Dominant Wavelength				Package
		Min.	Max.	Color Bin	Min.(nm)	Color Bin	Max.(nm)	
Green	CLM2D-GEC-CYaA0793	2800	7100	G7	520	G9	535	Reel
	CLM2D-GEC-CYaA0893	2800	7100	G8	525	G9	535	Reel
	CLM2D-GEC-CYbA0793	3550	7100	G7	520	G9	535	Reel
	CLM2D-GEC-CYbA0893	3550	7100	G8	525	G9	535	Reel
Blue	CLM2D-BEC-CUbWa453	560	1400	B4	465	B5	475	Reel
	CLM2D-BEC-CVaWa453	710	1400	B4	465	B5	475	Reel

Notes:

- The above kit numbers represent order codes that include multiple intensity-bin and color-bin codes. Only one intensity-bin code and one color-bin code will be shipped on each bulk. Single intensity-bin code and single color-bin codes will not be orderable.
- Please refer to the [HB LED Lamp Reliability Test Standards](#) document for reliability test conditions.
- Please refer to the [HB LED Lamp Soldering & Handling](#) document for information about how to use this LED product safely.

GRAPHS

The data below are collected from statistical figures that do not necessarily correspond to the actual parameters of each single LED. Hence, these data will be changed without further notice.

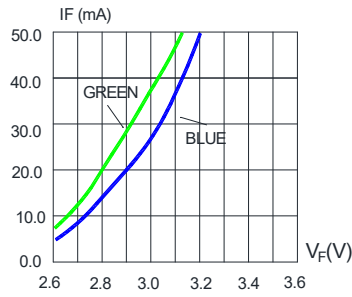

FIG.1 FORWARD CURRENT VS. FORWARD VOLTAGE.

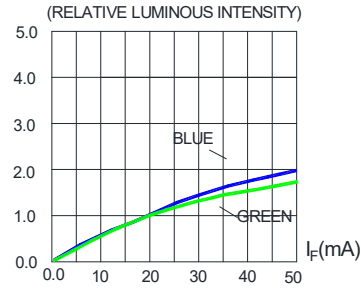

FIG.2 RELATIVE LUMINOUS INTENSITY VS. FORWARD CURRENT

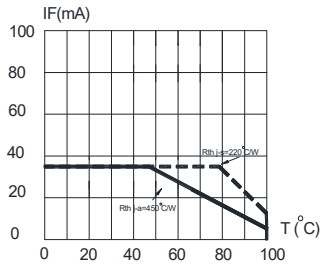

FIG.3 Green MAXIMUM FORWARD DC CURRENT VS AMBIENT TEMPERATURE ($T_{jmax}=110^{\circ}C$)

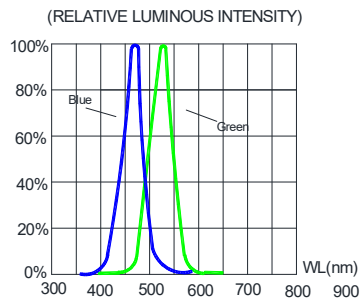

FIG.4 RELATIVE LUMINOUS INTENSITY VS. WAVELENGTH.

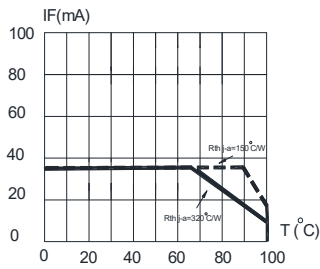

FIG.5 Blue MAXIMUM FORWARD DC CURRENT VS AMBIENT TEMPERATURE ($T_{jmax}=110^{\circ}C$)

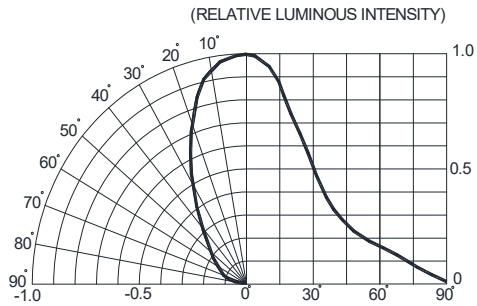
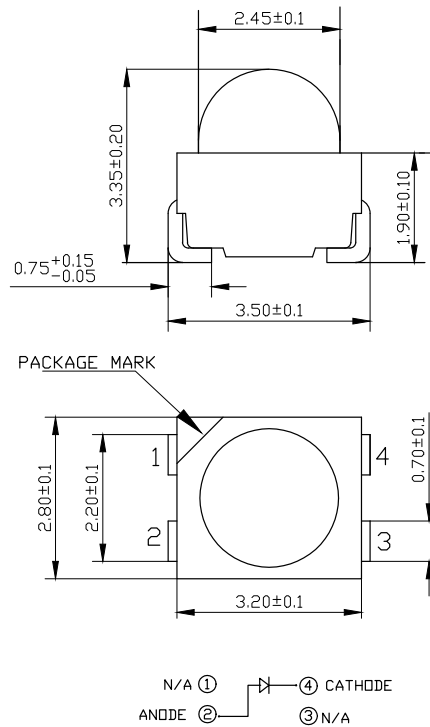

FIG.6 FAR FIELD PATTERN

MECHANICAL DIMENSIONS

All dimensions are in mm.



NOTES

RoHS Compliance

The levels of RoHS restricted materials in this product are below the maximum concentration values (also referred to as the threshold limits) permitted for such substances, or are used in an exempted application, in accordance with EU Directive 2011/65/EC (RoHS2), as implemented January 2, 2013. RoHS Declarations for this product can be obtained from your Cree LED representative or from the [Product Ecology](#) section of the Cree LED website.

Vision Advisory

WARNING: Do not look at an exposed lamp in operation. Eye injury can result.

KIT NUMBER SYSTEM

Cree LED lamps are tested and sorted into performance bins. A bin is specified by ranges of color, forward voltage, and brightness. Sorted LEDs are packaged for shipping in various convenient options.

Cree LEDs are sold by order codes in combinations of bins called kits. Order codes are configured in the following manner:



REFLOW SOLDERING

- The CLM2D-GEC/BEC is rated as a MSL 5a product.
- The recommended floor life out of bag is 24hrs.
- The temperature profile is as below.

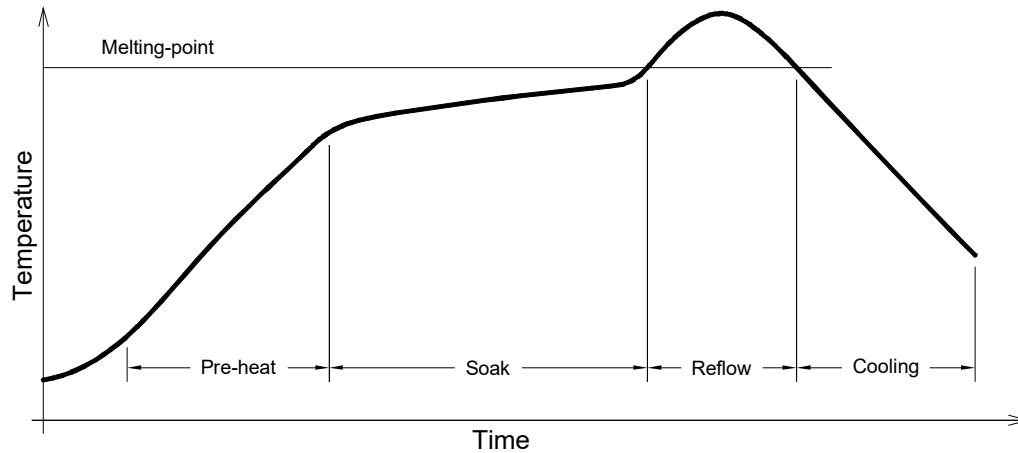

Use only with CLM2D-GEC/BEC

Solder
Average ramp-up rate = 4°C/s max
Preheat temperature = 150°C ~200°C
Preheat time = 120s max
Ramp-down rate = 6°C/s max
Peak temperature = 235°C max
Time within 5°C of actual Peak Temperature = 10s max
Duration above 217°C is 45s max

- The packaging sizes of these SMD products are very small and the resin is still soft after solidification. Users are required to handle with care. Never touch the resin surface of SMD products.
- To avoid damaging the product's surface and interior device, it is recommended to choose a special nozzle to pick up the SMD products during the process of SMT production. If handling is necessary, take special care when picking up these products. The following method is necessary:
- Please refer to the [HB LED Lamp Soldering & Handling](#) document for information about how to use this LED product safely.

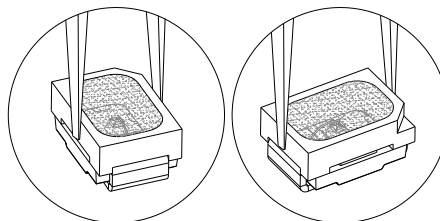

PACKAGING

- The LEDs are packed in cardboard boxes after packaging in normal or anti-electrostatic bags.
- Cardboard boxes will be used to protect the LEDs from mechanical shock during transportation.
- The boxes are not water resistant, and they must be kept away from water and moisture.
- The reel pack is applied in SMD LED.
- Max 2300 pcs per reel.

