

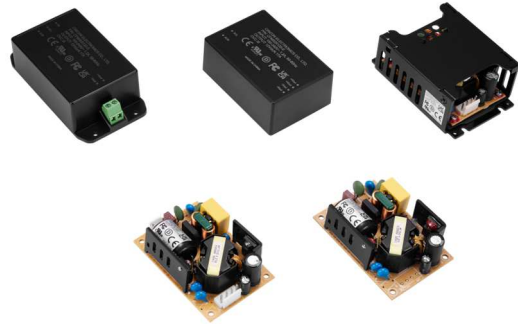

CFM50S SERIES 50 WATT OPEN FRAME AC-DC MODULES

Features

- Universal Input Range 85~264Vac
- High Efficiency up to 89%
- 2"x 3" Open Frame Compact Size
- Class I and Class II
- No Load Input Power < 0.15W
- Approval IEC/EN/UL 62368-1 Ed 3.0
- Meets IEC/EN 60335-1
- Approval EN 55032 Class B and CISPR/FCC Class B
- Operating Altitude 5000m
- Continuous Short Circuit Protection
- Over Voltage Protection
- Over Voltage Category OVC II & OVC III



MODEL NUMBER	OUTPUT VOLTAGE	OUTPUT CURRENT	VOLTAGE ACCURACY NOTE1	RIPPLE& NOISE NOTE2	LINE REGULATION NOTE3	LOAD REGULATION NOTE4	%EFF. (Typ.) NOTE5
CFM50S050	5 V	8 A	±2%	150 mV	±0.5%	±1%	85%
CFM50S120	12 V	4.17 A	±2%	120 mV	±0.5%	±1%	87%
CFM50S150	15 V	3.33 A	±1%	150 mV	±0.5%	±1%	88%
CFM50S240	24 V	2.08 A	±1%	240 mV	±0.5%	±1%	89%
CFM50S360	36 V	1.39 A	±1%	360 mV	±0.5%	±1%	89%
CFM50S480	48 V	1.04 A	±1%	480 mV	±0.5%	±1%	89%

Note:

1. Voltage accuracy is set at 100% full load.
2. Add a 0.1uF ceramic capacitor and a 10uF E.L. capacitor to output for ripple & noise measurement @20MHz BW.
3. Line regulation is measured from 90V_{ac} to 264V_{ac} with 100% full load.
4. Load regulation is measured from 10% to full load.
5. Typical efficiency at 230 V_{ac}.
6. Standard input and output connectors (CN1 and CN2) wafer with TAIWAN KING PIN TERMINAL PVHI series and mate with JST housing VHR series and JST SVH-41T-P1.1 series crimp terminal and output connectors wire 16AWG.

PART NUMBER

Series	Number of Outputs	Nominal Output Voltage	Type
CFM50	O	XX	-X (Option)
CFM50	S : Single	050 : 05V 120 : 12V 150 : 15V 240 : 24V 360 : 36V 480 : 48V	None : Wafer P : PCB Mount CA : Cover E : Encapsulated S : Terminal Block SD : Terminal Block with Din rail

Part Number Example:

CFM50S120: Open Frame, 50W, Single 12V_{dc} Output



CFM50S Series

TECHNICAL SPECIFICATIONS

(All specifications are typical at nominal input, full load at 25°C unless otherwise noted.)

ABSOLUTE MAXIMUM RATINGS

PARAMETER	NOTES and CONDITIONS	Device	Min.	Typ.	Max.	Units
Input Voltage	Safety approvals only to the AC input (DC input no safety)	All	85		264	V _{ac}
				120		370
Operating Temperature	See Derating Curve	All	-30		80	°C
Storage Temperature		All	-30		85	°C
Operating Altitude	IEC/EN/UL 62368-1 OVC II	All			5000	m
	IEC/EN 62368-1 OVC III				2000	
	Meets IEC/EN 60335-1 OVC II				3000	

INPUT CHARACTERISTICS

PARAMETER	NOTES and CONDITIONS	Device	Min.	Typ.	Max.	Units
Operating Voltage Range		All	100		240	V _{ac}
Input Frequency Range		All	50		60	Hz
Maximum Input Current	100% Load, V _{in} =100V _{ac}	All			1.2	A
Leakage Current		All			0.1	mA
Inrush Current	V _{in} =240V _{ac} , Cold start at 25°C	All		110		A

OUTPUT CHARACTERISTICS

PARAMETER	NOTES and CONDITIONS	Device	Min.	Typ.	Max.	Units
Output Voltage Set Point	V _{in} =Nominal V _{in} , I _o =I _o max., T _c =25°C	CFM50S050	4.90	5	5.10	V _{dc}
		CFM50S120	11.76	12	12.24	
		CFM50S150	14.85	15	15.15	
		CFM50S240	23.76	24	24.24	
		CFM50S360	35.64	36	36.36	
		CFM50S480	47.52	48	48.48	
Operating Output Current Range	V _{in} =115V _{ac} and 230V _{ac} , T _c =25°C	CFM50S050			8.0	A
		CFM50S120			4.17	
		CFM50S150			3.33	
		CFM50S240			2.08	
		CFM50S360			1.39	
		CFM50S480			1.04	
Holdup Time	V _{in} =115V _{ac}	All	8			ms
Output Voltage Regulation						
Load Regulation	10% Load to full load	All			±1.0	%
Line Regulation	V _{in} =High line to low line	All			±0.5	%
Over Voltage Protection	Hiccup mode (Auto recovery)	CFM50S050			6.3	V _{dc}
		CFM50S120			15.6	
		CFM50S150			18.0	
		CFM50S240			29.1	
		CFM50S360			43.3	
		CFM50S480			56.8	
Over Current Protection	Hiccup mode (Auto recovery)	All	110		140	%
Short Circuit Protection	Hiccup mode (Auto recovery)	All				



CFM50S Series

PARAMETER	NOTES and CONDITIONS	Device	Min.	Typ.	Max.	Units
Output Ripple and Noise	1. Add a 0.1uF ceramic capacitor and a 10uF aluminum electrolytic capacitor to output 2. Oscilloscope is 20MHz band width 3. Ambient Temperature=25°C	CFM50S050			150	mV
		CFM50S120			120	
		CFM50S150			150	
		CFM50S240			240	
		CFM50S360			360	
		CFM50S480			480	
Load Capacitance	1. $V_{in}=115V_{ac}$ and $230V_{ac}$ 2. Output is max. load 3. Ambient temperature=25°C	CFM50S050			8000	uF
		CFM50S120			4200	
		CFM50S150			3400	
		CFM50S240			2087	
		CFM50S360			1440	
		CFM50S480			600	
Efficiency	1. Output is rated load 2. Input voltage is $230V_{ac}$	CFM50S050		85		%
		CFM50S120		87		
		CFM50S150		88		
		CFM50S240		89		
		CFM50S360		89		
		CFM50S480		89		

ISOLATION CHARACTERISTICS

PARAMETER	NOTES and CONDITIONS	Device	Min.	Typ.	Max.	Units
Input to Output	1 Minute	All			4250	V_{ac}
Isolation Resistance	Input to output	All	100			MΩ

FEATURE CHARACTERISTICS

PARAMETER	NOTES and CONDITIONS	Device	Min.	Typ.	Max.	Units
Switching Frequency	Pout=max. rated power	All		65		kHz

GENERAL SPECIFICATIONS

PARAMETER	NOTES and CONDITIONS	Device	Min.	Typ.	Max.	Units
MTBF	$I_o=100\%$; $T_a=25^\circ C$ per MIL-HDBK-217F	All		1200		k hours
Humidity	Non-condensing	All			93	% RH
Shock	Meet MIL-STD-810F Table 516.5, Table 516.5-I 10ms, each axis 3 times ($\pm X$ 、 $\pm Y$ 、 $\pm Z$ axis)	All		75		g
Vibration	Meet MIL-STD-810F Table 514.5C-VIII, 15~2000Hz, X、Y、Z axis, 1 hour (each axis). Total 3 hrs.	All		4		g
Weight		CFM50S		95		grams
		CFM50S-P		93		
		CFM50S-CA		180		
		CFM50S-E		222		
		CFM50S-S		233		
		CFM50S-SD		330		
Dimensions	Open Frame (Wafer)	All	3.000x2.000x1.067 Inches (76.20x50.80x27.1 mm)			
	P (PCB Mount)		3.000x2.000x1.142 Inches (76.20x50.80x29mm)			
	CA (Cover)		3.598x2.520x1.358 Inches (91.40x64.00x34.50 mm)			
	E (Encapsulated)		2.170x3.140x1.201Inches (55.20x79.80x30.50 mm)			
	S (Terminal Block)		2.170x4.200x1.201Inches (55.20x106.60x30.50 mm)			
	SD (Din rail type)		2.170x4.200x1.784Inches (55.20x106.60x45.31 mm)			



CFM50S Series

GENERAL SPECIFICATIONS

Safety	Class I, Class II, IEC/EN/UL62368-1	Ed 3.0
EMC Emission	EN 55032:2015+AC:2016, 47 CFR FCC Part 15 Subpart B, EN 61000-3-2:2019, EN 61000-3-3:2013	Class B
Conducted Disturbance	EN 55032, 47 CFR FCC Part 15	Class B
Radiated Disturbance	EN 55032, 47 CFR FCC Part 15	Class B
Harmonic Current Emissions	EN 61000-3-2:2019	
Voltage Fluctuations & Flicker	EN 61000-3-3:2013	
EMC Immunity	EN 55035:2017	
Electrostatic Discharge (ESD)	IEC 61000-4-2:2008, Air Discharge: $\pm 8\text{kV}$, Contact Discharge: $\pm 4\text{kV}$	Criterion A
Radio-Frequency, Continuous Radiated Disturbance	IEC 61000-4-3:2020	Criterion A
Electrical Fast Transient (EFT)	IEC 61000-4-4:2012, $\pm 0.5\text{kV}$, $\pm 1\text{kV}$, $\pm 2\text{kV}$	Criterion A
Surge	IEC61000-4-5:2014, L-N: $\pm 2\text{kV}$, L-E (Ground): $\pm 4\text{kV}$	Criterion A
Conducted Disturbances, Induced by RF Fields	IEC 61000-4-6:2013	Criterion A
Power Frequency Magnetic Field	IEC 61000-4-8:2009	Criterion A
Voltage Dips	IEC 61000-4-11:2004, Dip: 30% Reduction, Dip >95% Reduction	Criterion A
Voltage Interruptions	IEC 61000-4-11:2004, >95% Reduction	Criterion B
Application Note Link	CFM50S Series App Notes	

CHARACTERISTIC CURVE

Power Derating Curve

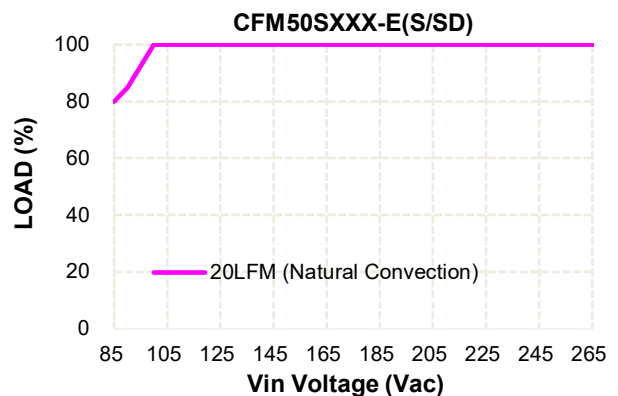
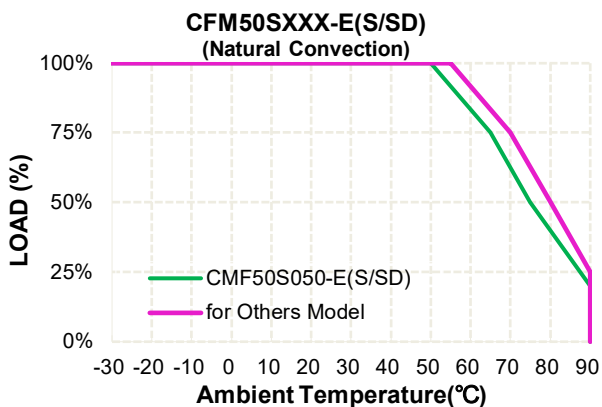
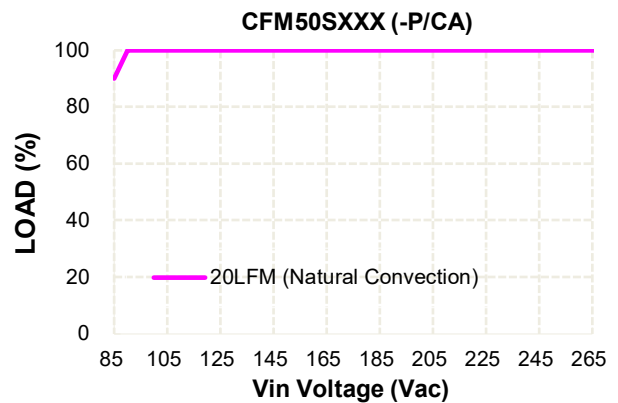
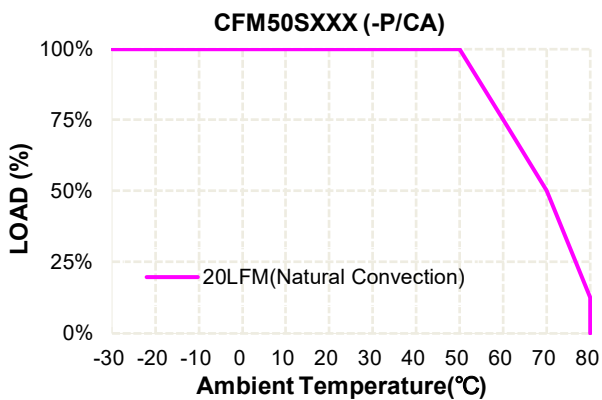



CFM50S Series

Performance Data

CFM50S050 (Eff Vs Io)

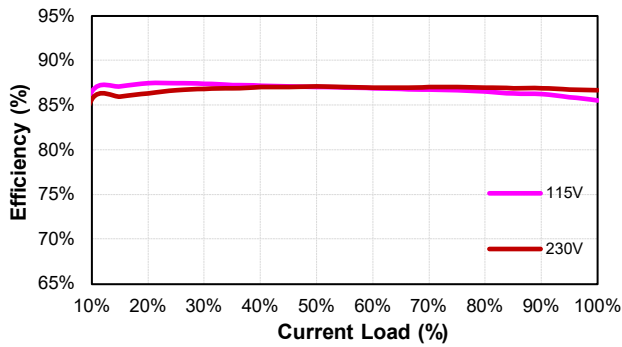

CFM50S120 (Eff Vs Io)

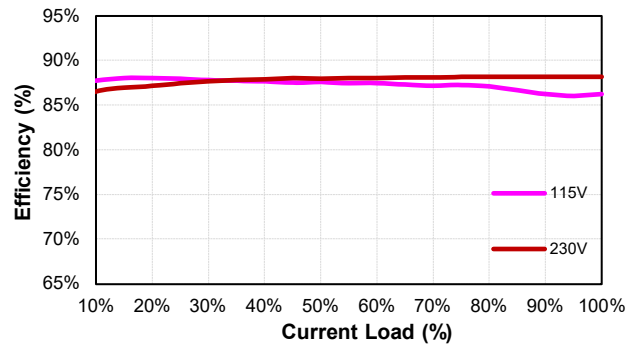

CFM50S150 (Eff Vs Io)

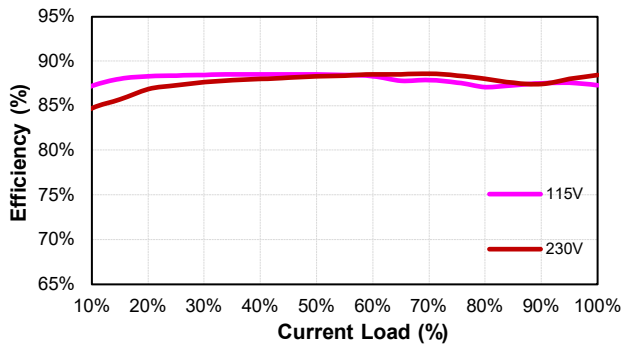

CFM50S240 (Eff Vs Io)

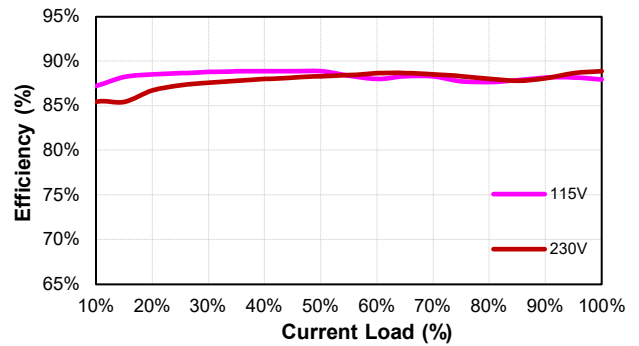

CFM50S360 (Eff Vs Io)

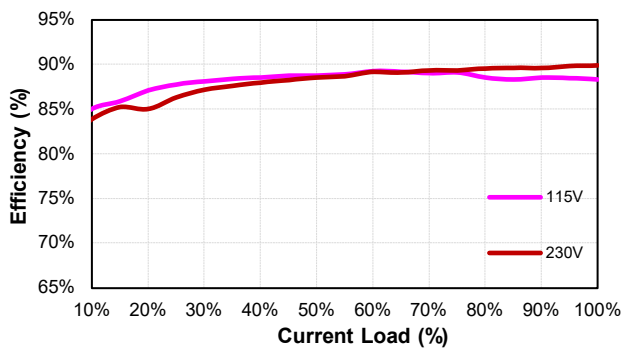

CFM50S480 (Eff Vs Io)

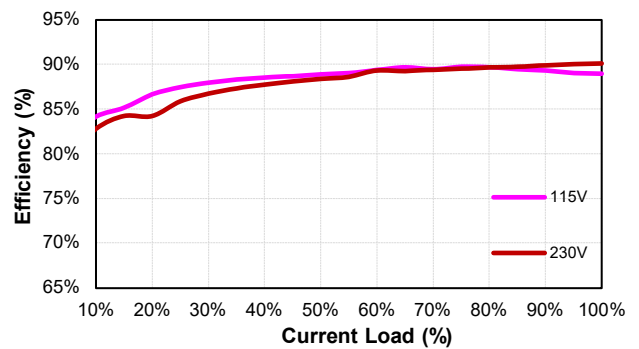

MECHANICAL SPECIFICATION

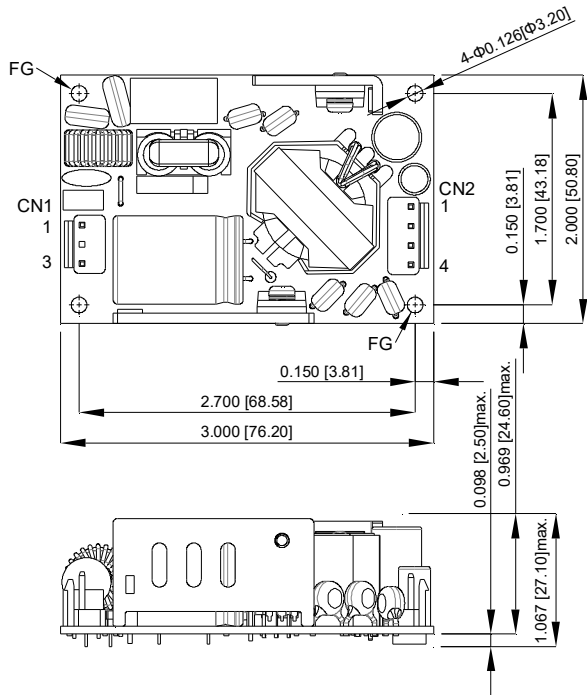

CFM50SXXX

AC Input Connector(CN1):TKP PVHI-03N2 or equivalent

Pin	Function	Mating Housing	Terminal
1	ACL	JST VHR-3N or equivalent	JST SVH-21T-P1.1 or equivalent
2	-		
3	ACN		

DC Output Connector(CN2):TKP PVHI-04 or equivalent

Pin	Function	Mating Housing	Terminal
1	+Vout	JST VHR-4N or equivalent	JST SVH-21T-P1.1 or equivalent
2	+Vout		
3	-Vout		
4	-Vout		

All Dimensions in Inches[mm]

Tolerance Inches : X.XXX=±0.02

Millimeters : X.XX=±0.5

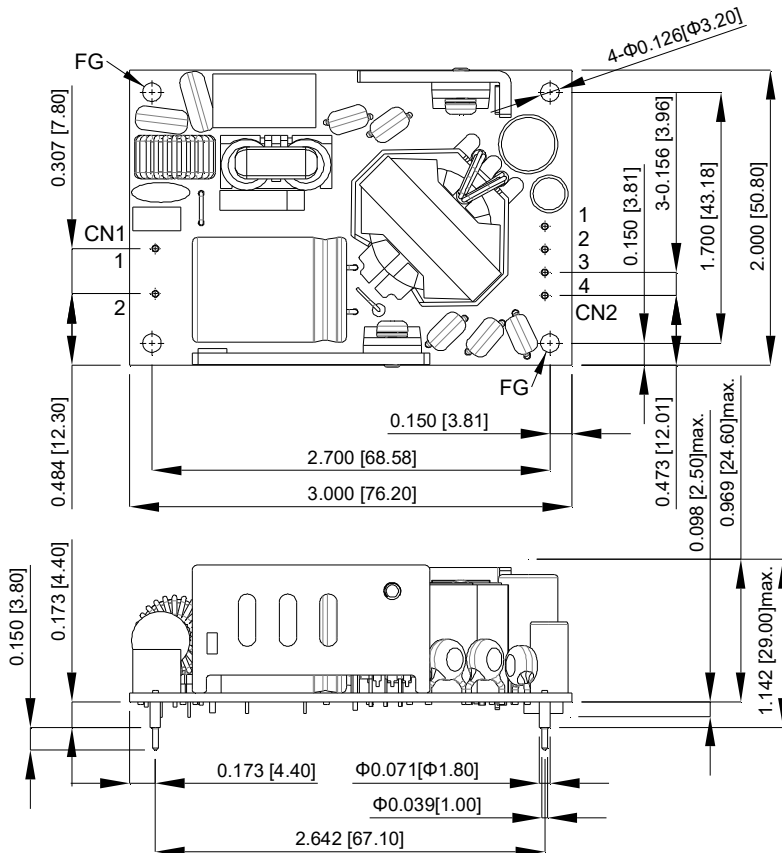

CFM50SXXX-P

CN1

PIN CONNECTION	
Pin	Function
1	ACL
2	ACN

CN2

PIN CONNECTION	
Pin	Function
1	+Vout
2	+Vout
3	-Vout
4	-Vout

All Dimensions in Inches[mm]

Tolerance Inches : X.XXX=±0.02

Millimeters : X.XX=±0.5



CFM50S Series

MECHANICAL SPECIFICATION

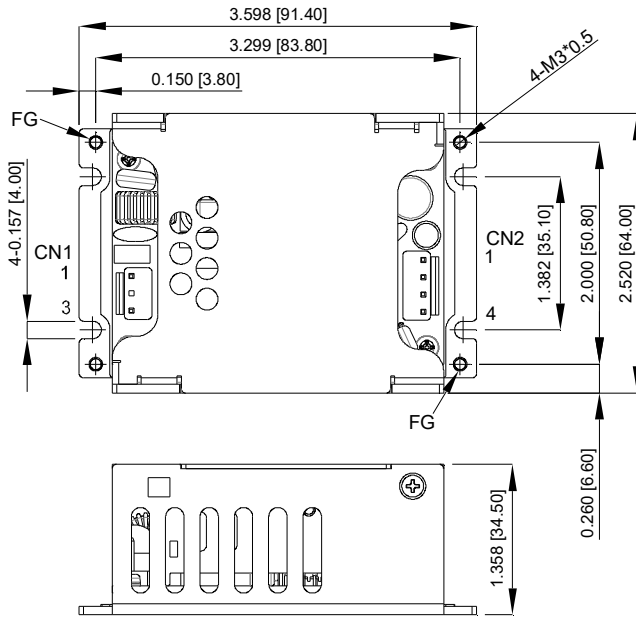

CFM50SXXX-CA

AC Input Connector(CN1):TKP PVHI-03N2 or equivalent

Pin	Function	Mating Housing	Terminal
1	ACL	JST VHR-3N or equivalent	JST SVH-21T-P1.1 or equivalent
2	-		
3	ACN		

DC Output Connector(CN2):TKP PVHI-04 or equivalent

Pin	Function	Mating Housing	Terminal
1	+Vout	JST VHR-4N or equivalent	JST SVH-21T-P1.1 or equivalent
2	+Vout		
3	-Vout		
4	-Vout		

All Dimensions in Inches[mm]
Tolerance Inches : X.XXX=±0.02
Millimeters : X.XX=±0.5

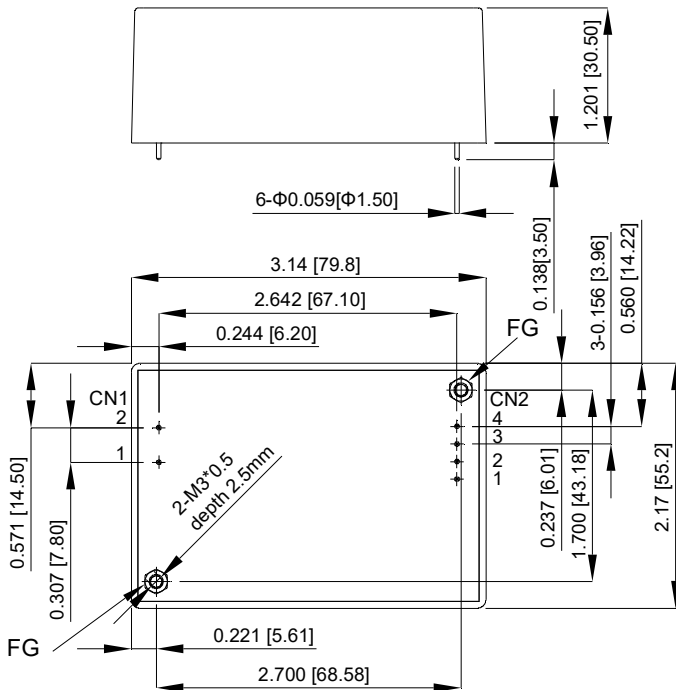

CFM50SXXX-E

PIN CONNECTION		
Pin	Function	Wafer
1	ACL	CN1
2	ACN	
1	+Vout	CN2
2	+Vout	
3	-Vout	
4	-Vout	

All Dimensions in Inches[mm]
Tolerance Inches : x.xx=±0.03,x.xxx=±0.02
Millimeters : x.x=±0.7,x.xx=±0.5



CFM50S Series

MECHANICAL SPECIFICATION

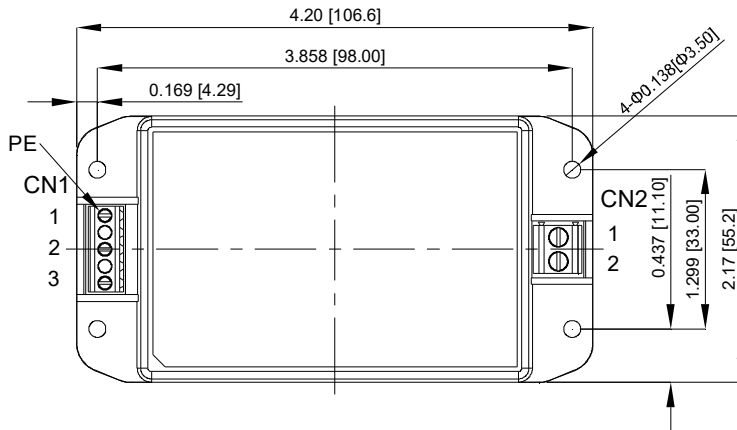

CFM50SXXX-S

AC Input Connector(CN1):DINKLE EK350V-03P5 or equivalent

Pin	Function	Mating Wire Range
1	PE	16~30 AWG
2	ACL	
3	ACN	

DC Output Connector(CN2):DINKLE EK500V-02P or equivalent

Pin	Function	Mating Wire Range
1	+Vout	12~16 AWG
2	-Vout	

All Dimensions in Inches[mm]
Tolerance Inches: x.xx=±0.03, x.xxx=±0.020
Millimeters: x.x=±0.7, x.xx=±0.50

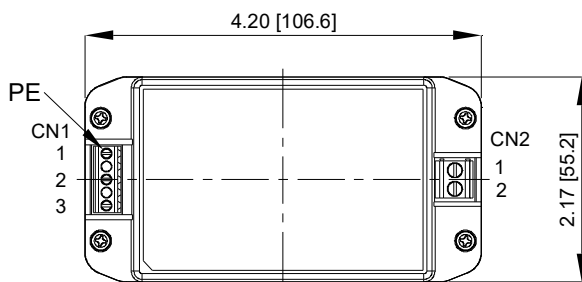

CFM50SXXX-SD

AC Input Connector(CN1):DINKLE EK350V-03P5 or equivalent

Pin	Function	Mating Wire Range
1	PE	16~30 AWG
2	ACL	
3	ACN	

DC Output Connector(CN2):DINKLE EK500V-02P or equivalent

Pin	Function	Mating Wire Range
1	+Vout	12~16 AWG
2	-Vout	

All Dimensions in Inches[mm]
Tolerance Inches: x.xx=±0.03, x.xxx=±0.020
Millimeters: x.x=±0.7, x.xx=±0.50

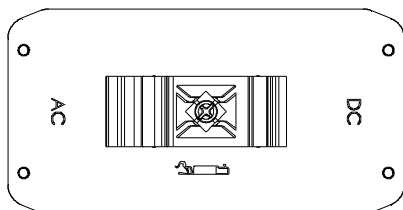
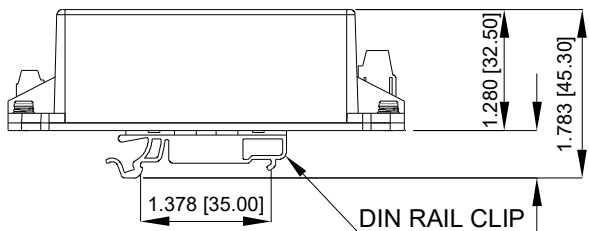

CINCON Electronics Co. Ltd.
Add: 14F, No. 306, Sec.4, Hsin Yi Rd., Taipei, Taiwan
Tel: 886-2-27086210
Fax: 886-2-27029852
E-mail: sales@cincon.com.tw
Web: www.cincon.com